

US00D668692S

(12) **United States Design Patent**
Noon

(10) **Patent No.:** **US D668,692 S**
(45) **Date of Patent:** **** Oct. 9, 2012**

- (54) **SPREADER CARRIER**
- (75) Inventor: **Matthew Noon**, Hudson, MA (US)
- (73) Assignee: **Noon Lawn & Landscape Co., Inc.**, Hudson, MA (US)
- (**) Term: **14 Years**
- (21) Appl. No.: **29/419,108**
- (22) Filed: **Apr. 25, 2012**
- (51) **LOC (9) Cl.** **15-03**
- (52) **U.S. Cl.** **D15/28**
- (58) **Field of Classification Search** D15/10, D15/27, 28; D12/408, 414.1, 400, 406, 162, D12/169; 224/488, 414, 400, 402, 521-525, 224/529, 530, 506, 510, 511, 532, 533, 537, 224/546, 405, 322, 324; 414/462; 296/3; 280/769; 108/44
See application file for complete search history.

- 5,586,702 A * 12/1996 Sadler 224/521
 - D437,285 S * 2/2001 McCoy et al. D12/406
 - 6,752,328 B2 * 6/2004 Sauls 239/175
 - 6,802,441 B1 * 10/2004 DuRant et al. 224/513
 - D508,014 S * 8/2005 Heravi D12/406
 - D527,028 S * 8/2006 Ford D15/28
 - 2003/0226867 A1 * 12/2003 Knizner 224/521
- * cited by examiner

Primary Examiner — Mark Goodwin
(74) *Attorney, Agent, or Firm* — Clock Tower Law Group; Erik J. Heels; Michael A. Bartley

(57) **CLAIM**
The ornamental design for a spreader carrier, as shown and described.

DESCRIPTION

FIG. 1 is a perspective view of a spreader carrier showing my new design;
FIG. 2 is a right side view thereof;
FIG. 3 is a left side view thereof;
FIG. 4 is a front side view thereof;
FIG. 5 is a rear side view thereof;
FIG. 6 is a top plan view thereof;
FIG. 7 is a bottom plan view thereof; and,
FIG. 8 is an alternate perspective view thereof shown in use condition, attached to the front of a vehicle.
The broken line showing of various surface elements in FIGS. 1-8 is included for the purpose of illustrating unclaimed portions of the spreader carrier and the showing of a vehicle in FIG. 8 is for environmental purposed only and forms no part of the claimed design.

1 Claim, 8 Drawing Sheets

(56) **References Cited**

U.S. PATENT DOCUMENTS

3,891,132	A *	6/1975	Chandler	224/509
4,089,276	A *	5/1978	Enos	108/44
4,744,590	A *	5/1988	Chesney	280/769
4,775,282	A *	10/1988	Van Vliet	414/462
4,804,120	A *	2/1989	Kraklio	224/536
4,815,638	A *	3/1989	Hutyra	224/525
5,038,981	A *	8/1991	McDaniel	224/512
5,046,664	A *	9/1991	van der Lely et al.	239/661

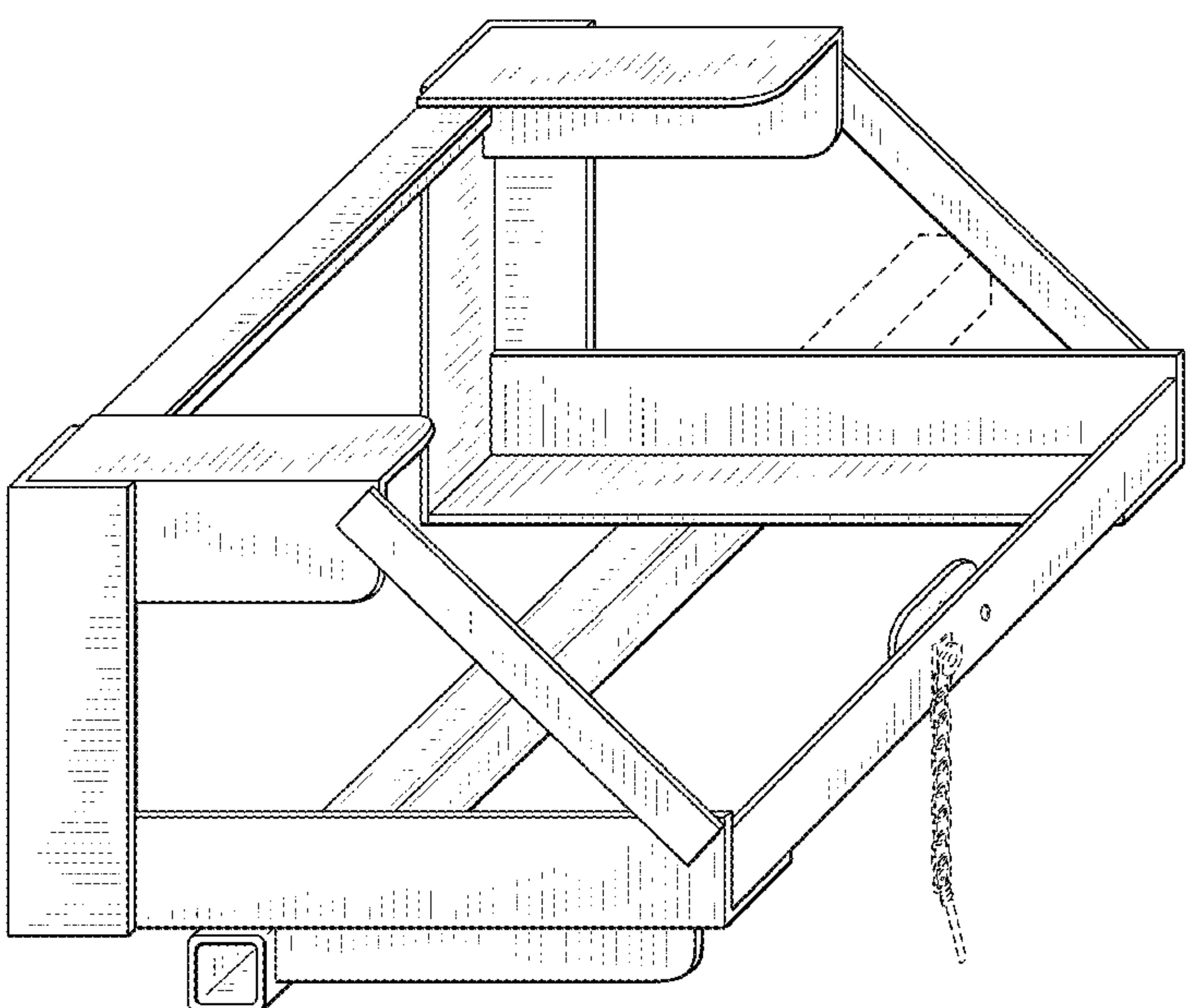

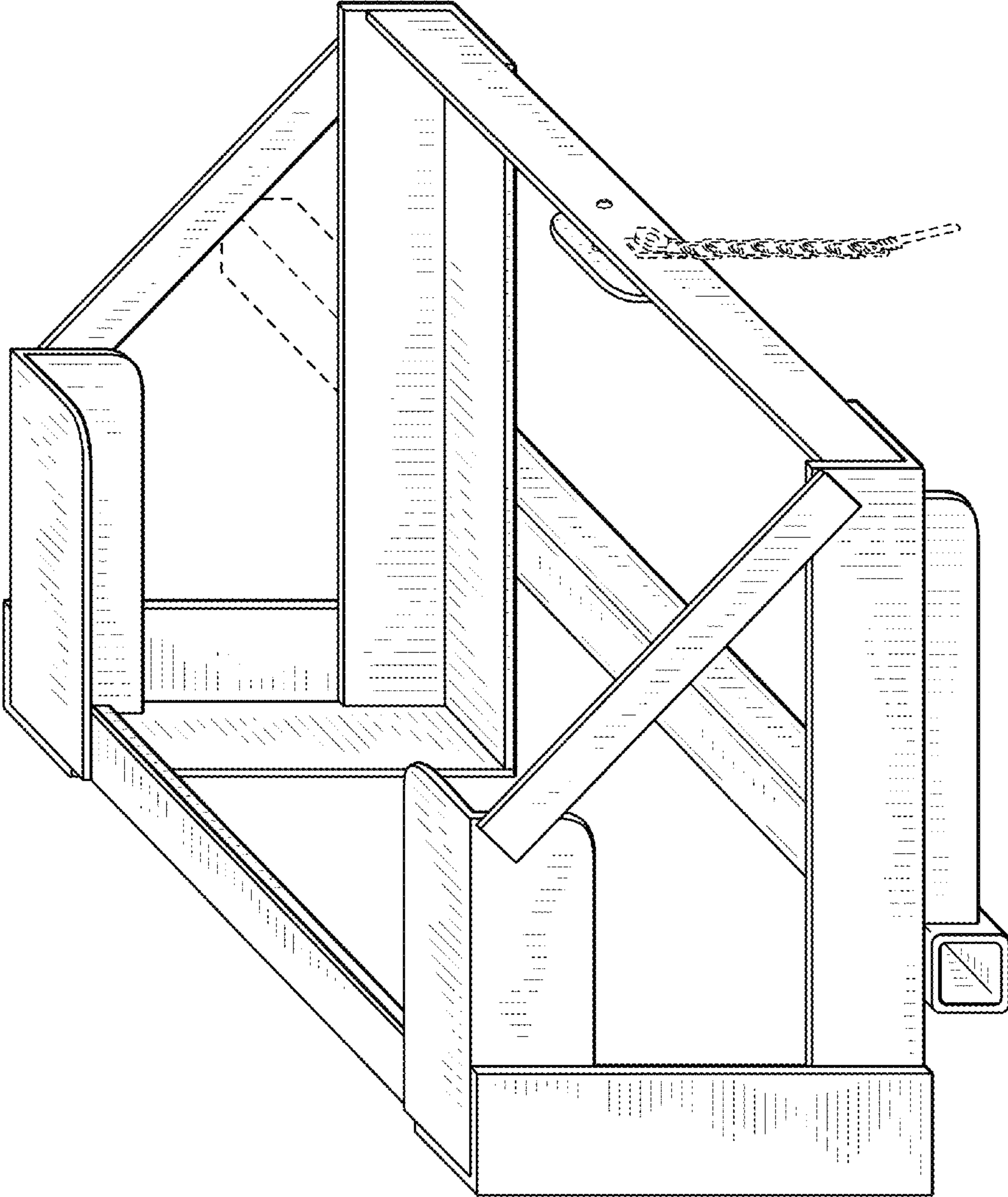

FIG. 1

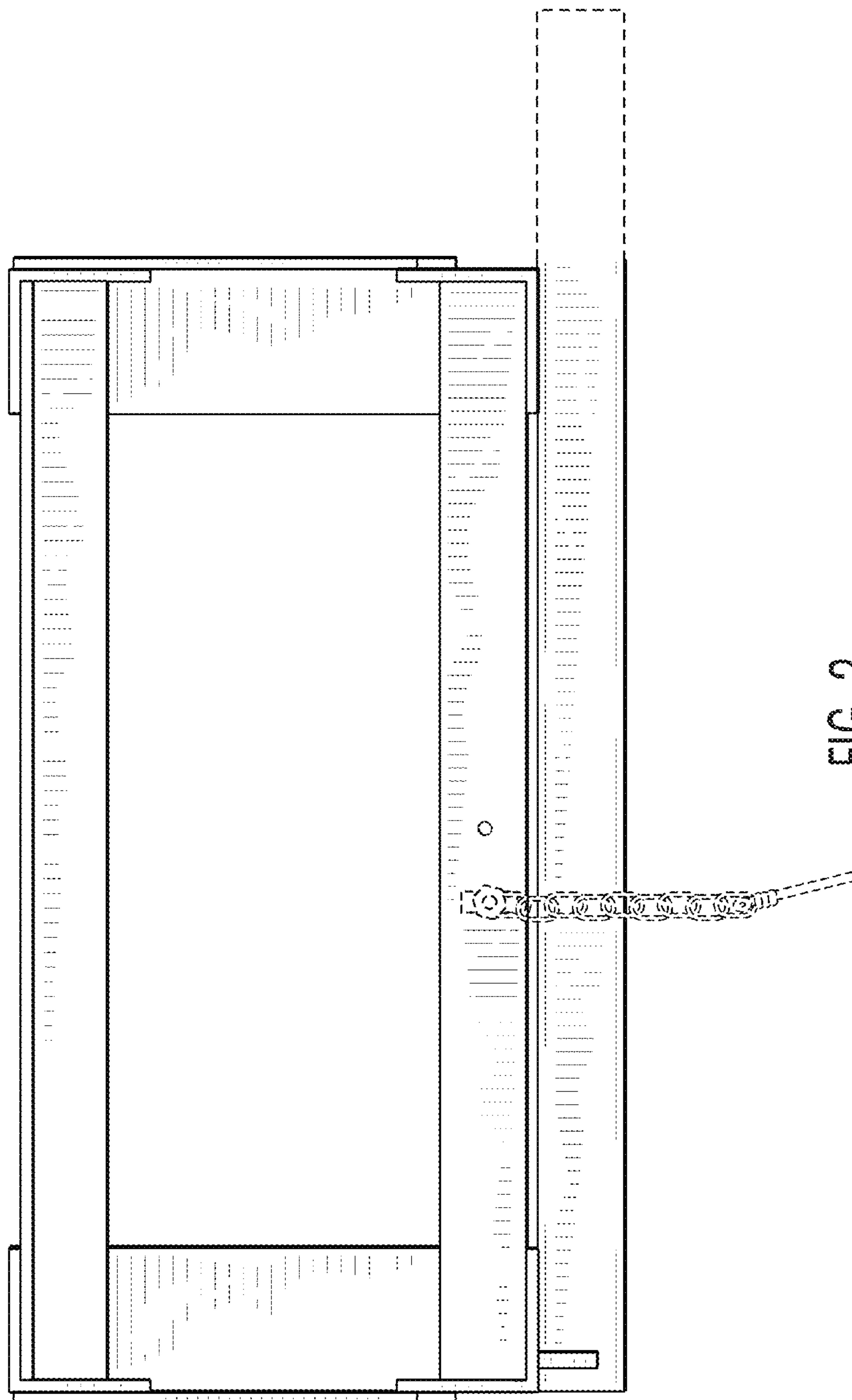

FIG. 2

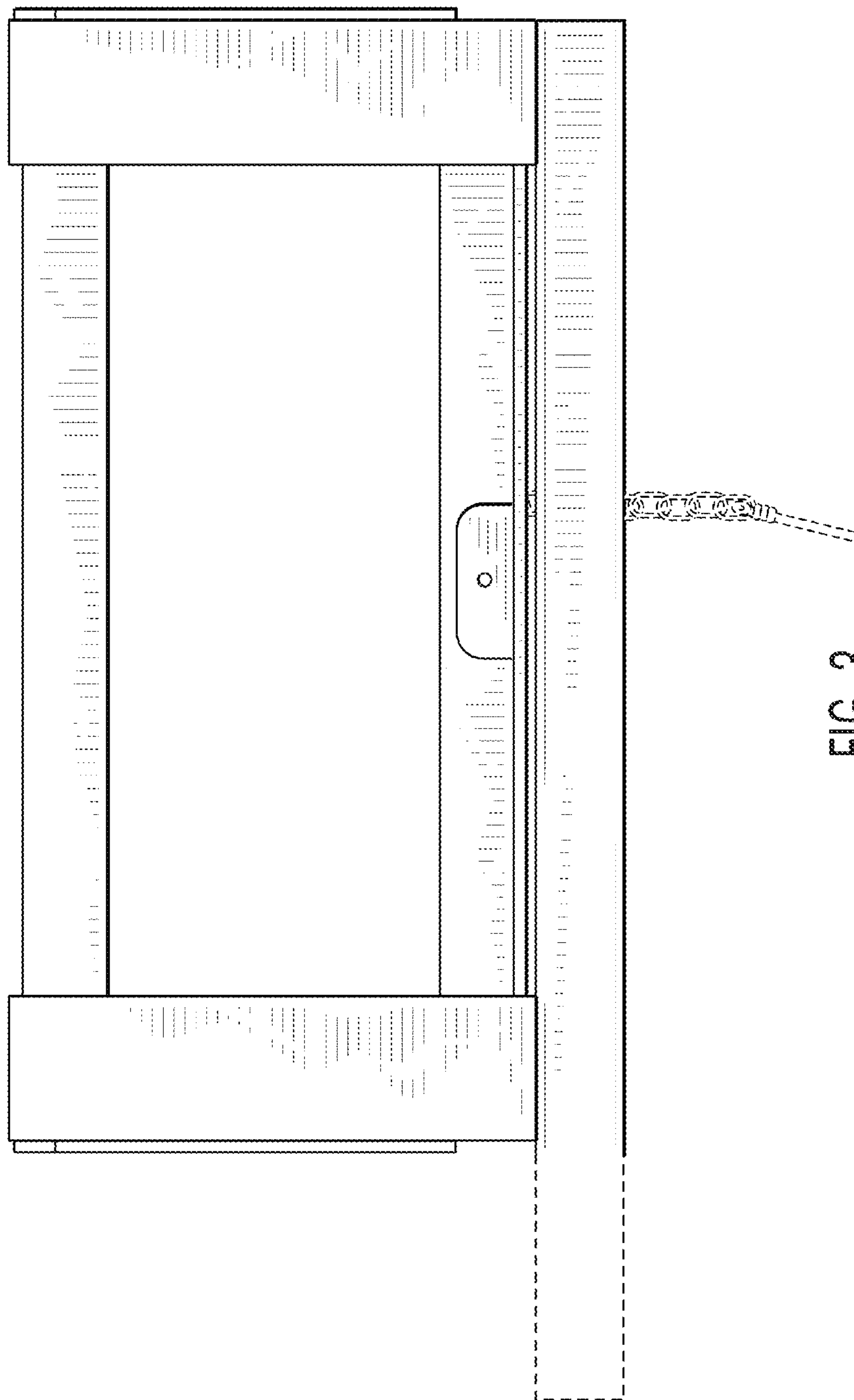
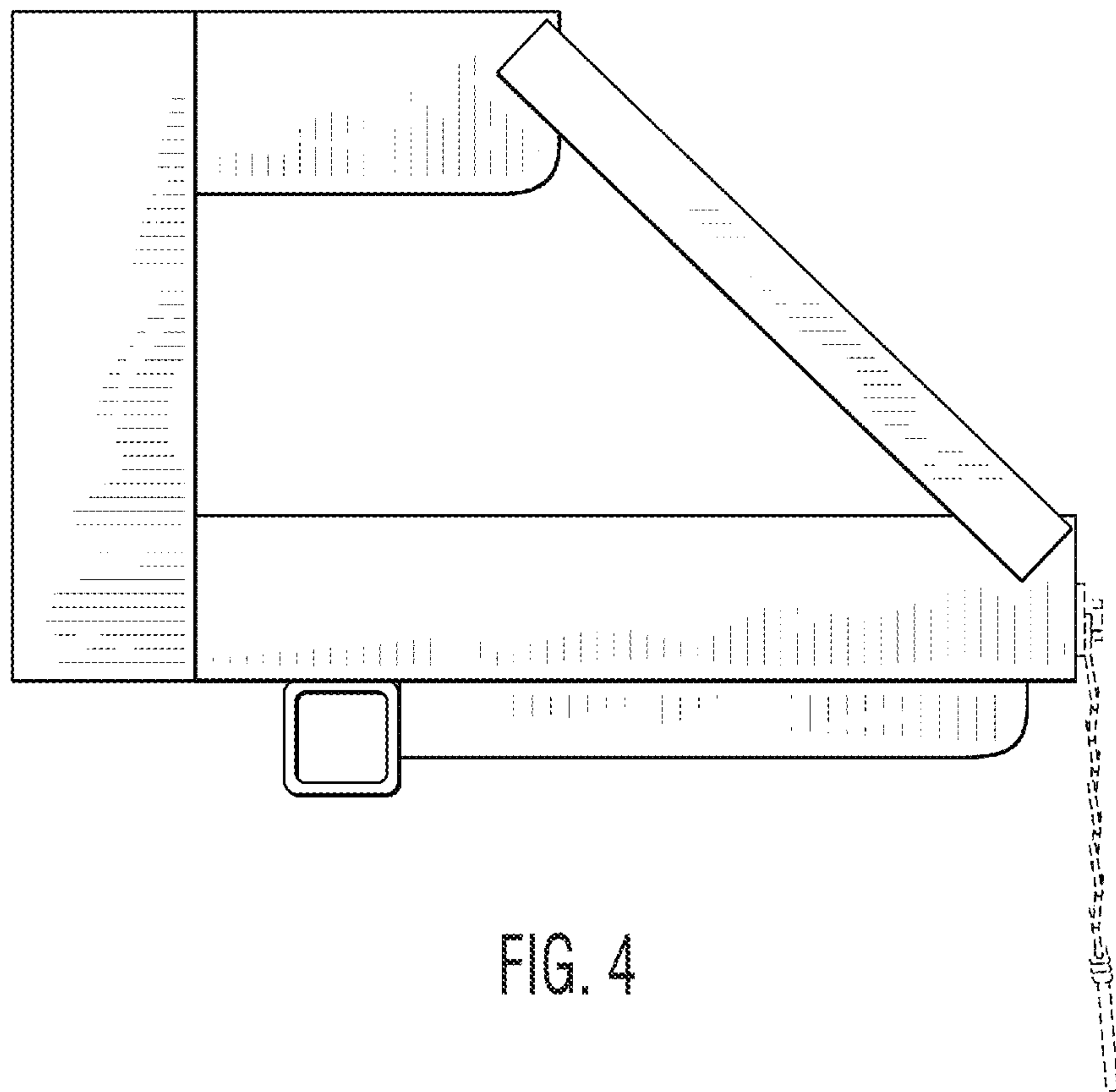

FIG. 3



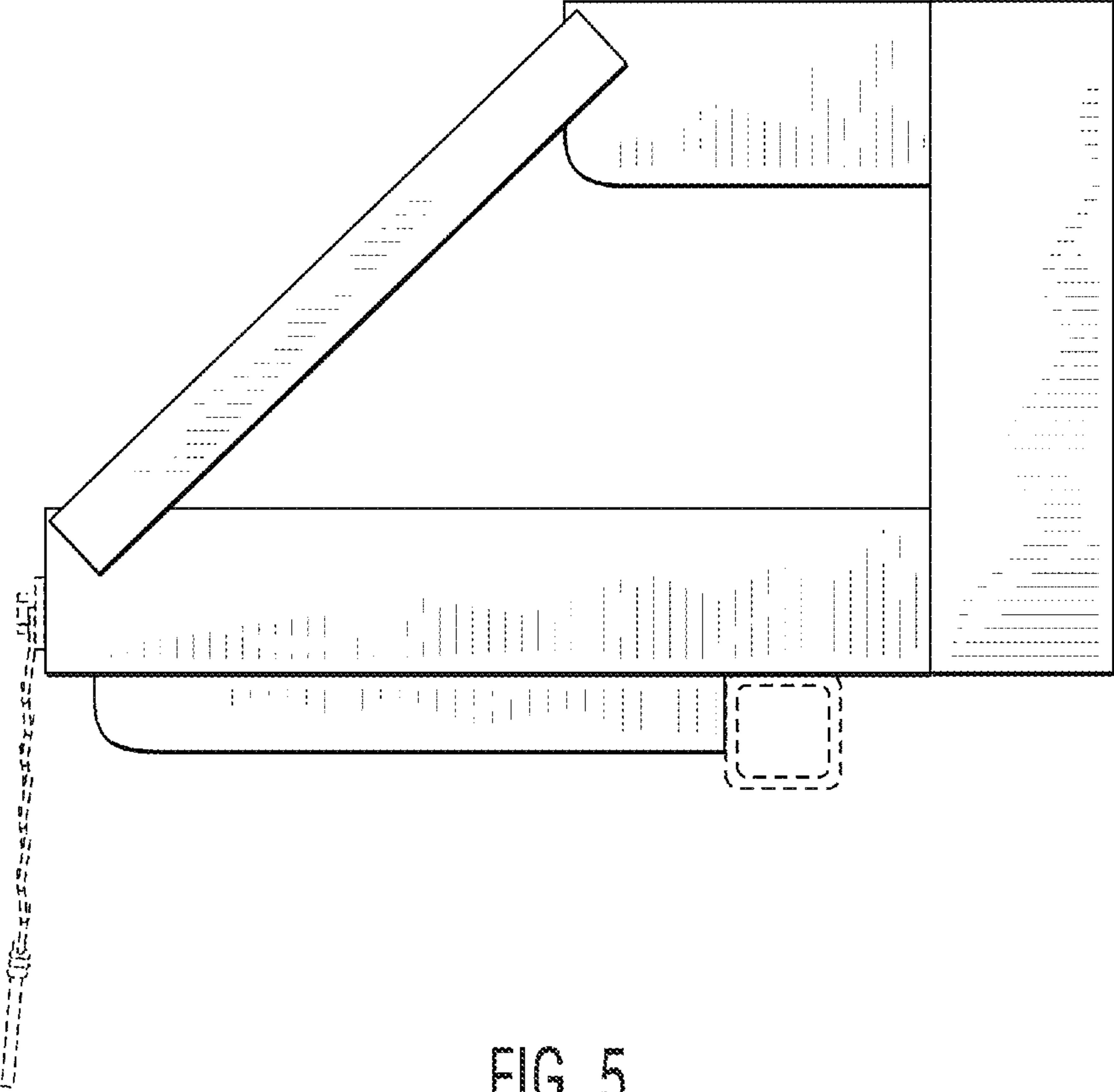

FIG. 5

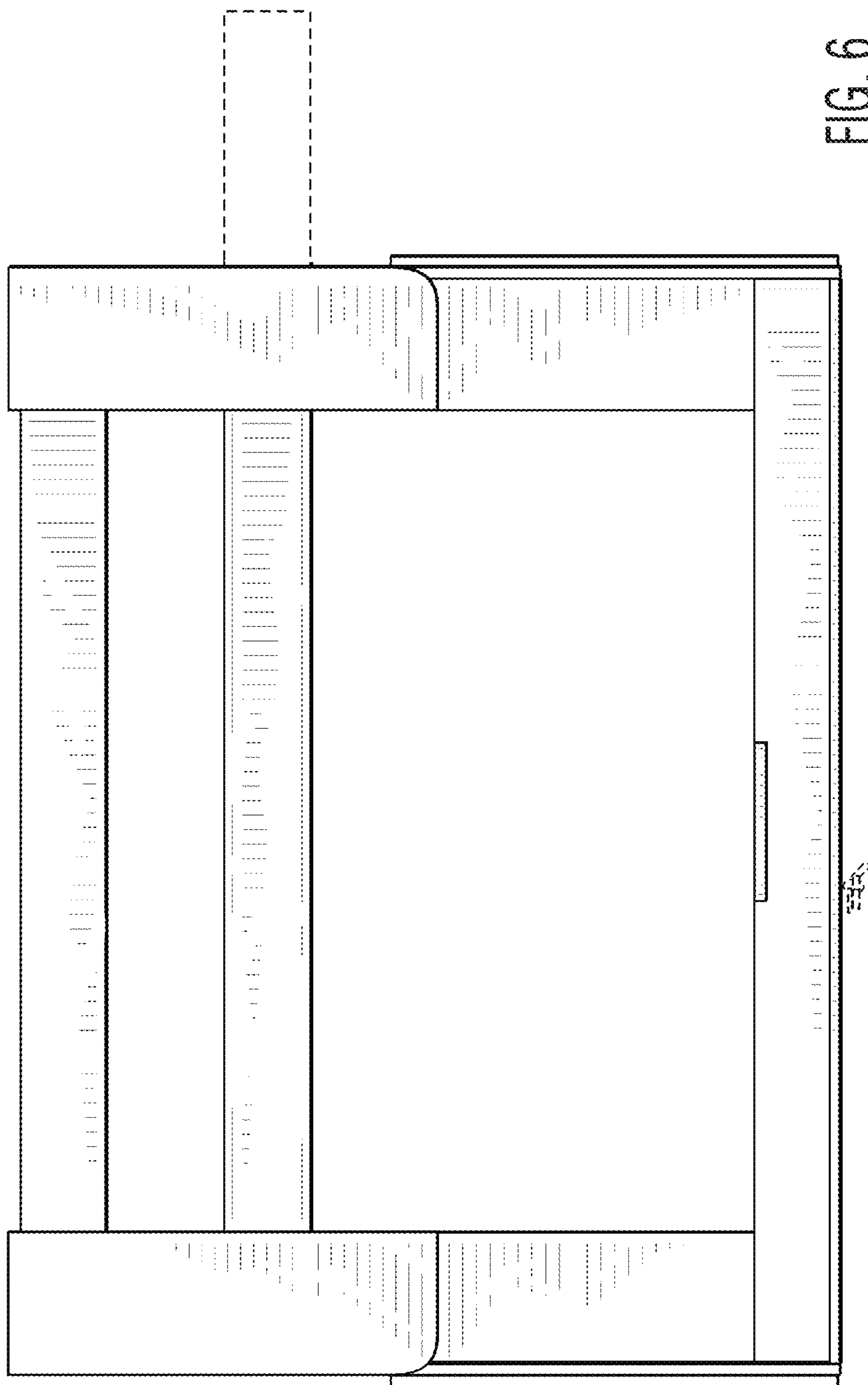

FIG. 6

FIG. 6

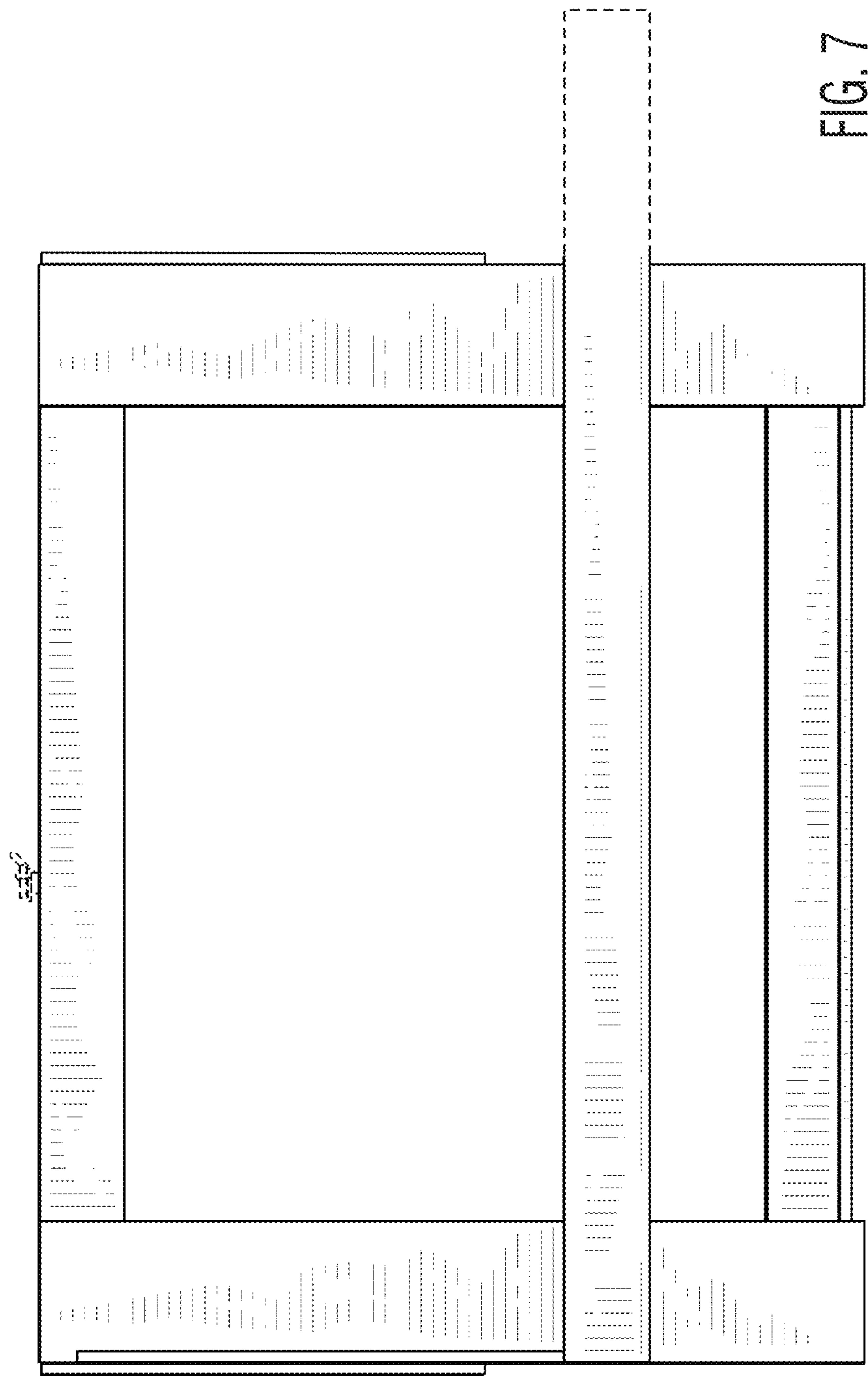

FIG. 7

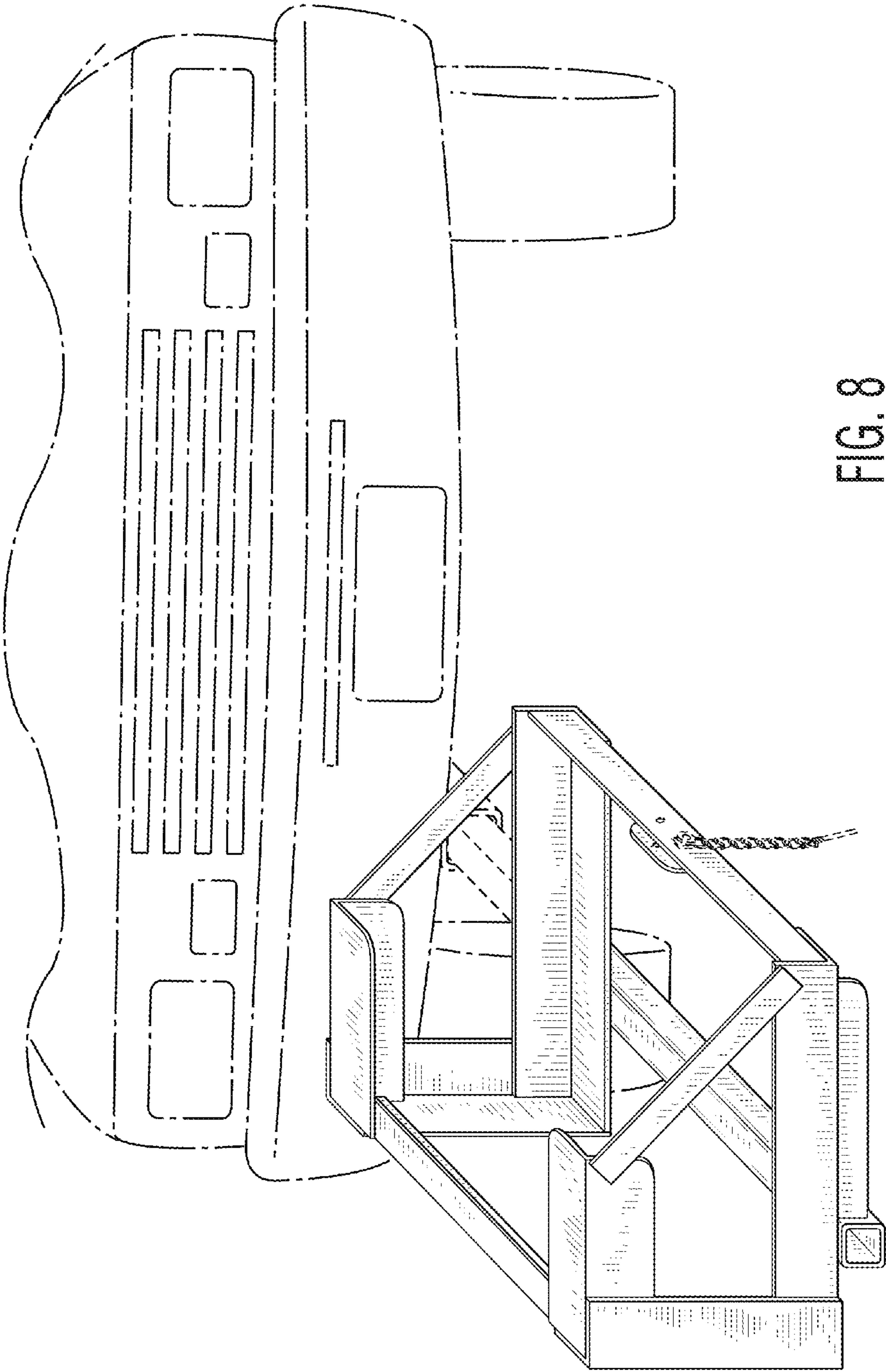

FIG. 8