



US00D668690S

(12) **United States Design Patent**  
**Bang**

(10) **Patent No.:** **US D668,690 S**

(45) **Date of Patent:** **\*\* Oct. 9, 2012**

(54) **SKIDPROOF PLATE FOR AN EXCAVATOR**

(75) Inventor: **Jang Hoon Bang**, Changwon-si (KR)

(73) Assignee: **Volvo Constructions Equipment AB**,  
Eskilstuna (SE)

(\*\*) Term: **14 Years**

(21) Appl. No.: **29/394,074**

(22) Filed: **Jun. 13, 2011**

(30) **Foreign Application Priority Data**

Mar. 29, 2011 (KR) ..... 30-2011-0012533

(51) **LOC (9) Cl.** ..... **15-03**

(52) **U.S. Cl.** ..... **D15/28; D12/203**

(58) **Field of Classification Search** ..... D15/10,  
D15/28; D12/203, 400; D25/62, 69, 68,  
D25/63; 280/163-166, 757, 164.1, 164.2,  
280/169, DIG. 10; 182/90, 92

See application file for complete search history.

(56) **References Cited**

**U.S. PATENT DOCUMENTS**

1,178,723	A *	4/1916	Hudson	280/169
1,294,904	A *	2/1919	Hayne	280/169
1,597,638	A *	8/1926	Vincent	280/169
1,675,665	A *	7/1928	Ritz Woller	280/169
2,991,118	A *	7/1961	Sleger	296/62
3,378,278	A *	4/1968	Letzel et al.	280/163
D225,160	S *	11/1972	Thomas	D12/203
3,915,475	A *	10/1975	Casella et al.	280/166
D238,867	S *	2/1976	Howells	D25/69
D279,607	S *	7/1985	Rutter	D25/69
4,569,533	A *	2/1986	Gronert et al.	280/163
H421	H *	2/1988	Glommen	280/169
D296,321	S *	6/1988	Hayes	D12/203
4,749,191	A *	6/1988	Gipson et al.	280/164.2
D306,278	S *	2/1990	Hafvenstein	D12/203
D308,356	S *	6/1990	Strahan	D12/203
D313,388	S *	1/1991	Dale	D12/203
D340,904	S *	11/1993	Bevier	D12/203
D343,692	S *	1/1994	Rainio	D25/69
D364,597	S *	11/1995	Branch	D12/203

D365,544	S *	12/1995	Snyder et al.	D12/203
D370,566	S *	6/1996	Koster et al.	D5/1
D384,020	S *	9/1997	Snyder et al.	D12/203
D394,628	S *	5/1998	Wentzel	D12/203
D402,998	S *	12/1998	Allen	D15/28
D402,999	S *	12/1998	Allen	D15/28
D412,754	S *	8/1999	Harden	D25/69
D440,931	S *	4/2001	Knight et al.	D12/203
D445,076	S *	7/2001	Weinerman	D12/203
D469,449	S *	1/2003	Andrews	D15/33
D471,288	S *	3/2003	Feik	D25/68
7,044,487	B2 *	5/2006	Byrne	280/163
D537,399	S *	2/2007	Riddle	D12/203
D573,929	S *	7/2008	Black	D12/203
7,401,560	B2 *	7/2008	McCrary	105/457
7,416,232	B2 *	8/2008	Tier et al.	293/117
D594,564	S *	6/2009	Disch et al.	D25/69
D649,563	S *	11/2011	Doraivelmanimoz	D15/28
D656,241	S *	3/2012	Greaves et al.	D25/69
2002/0003340	A1 *	1/2002	Hallquist	280/163
2004/0178602	A1 *	9/2004	King et al.	280/163

\* cited by examiner

*Primary Examiner* — Mark Goodwin

(74) *Attorney, Agent, or Firm* — Ladas & Parry LLP

(57) **CLAIM**

The ornamental design for skidproof plate for an excavator, as shown and described.

**DESCRIPTION**

FIG. 1 is a perspective view of skidproof plate for an excavator according to my new design;  
 FIG. 2 is a front view thereof;  
 FIG. 3 is a rear view thereof;  
 FIG. 4 is an enlarged left side view thereof;  
 FIG. 5 is an enlarged right side view thereof;  
 FIG. 6 is a top view thereof;  
 FIG. 7 is a bottom view thereof; and,  
 FIG. 8 is a reference view of skidproof plate for an excavator according to my new design.  
 The broken line showing of cab is included for the purpose of illustrating environmental structure only and forms no part of the claimed design.

**1 Claim, 5 Drawing Sheets**

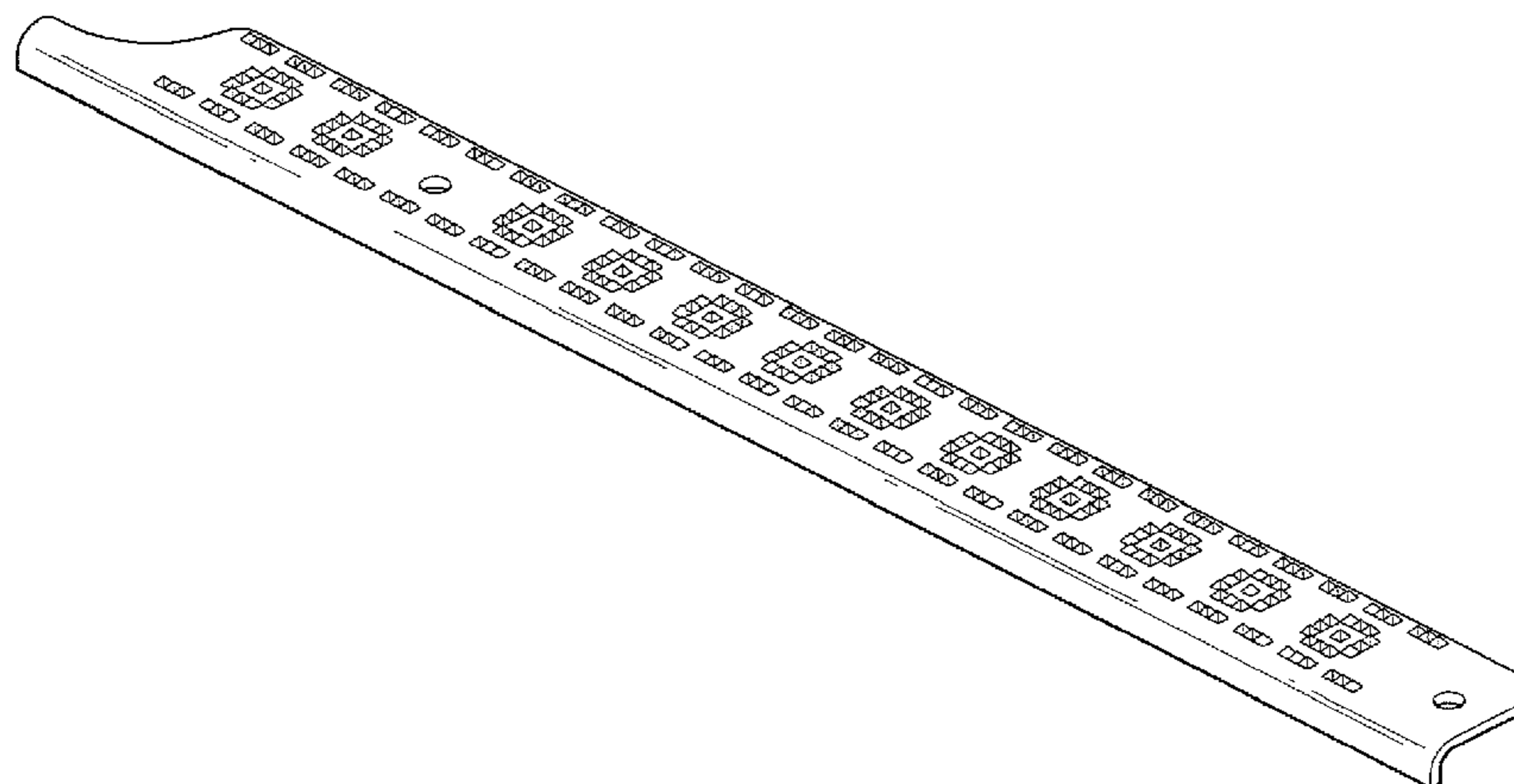
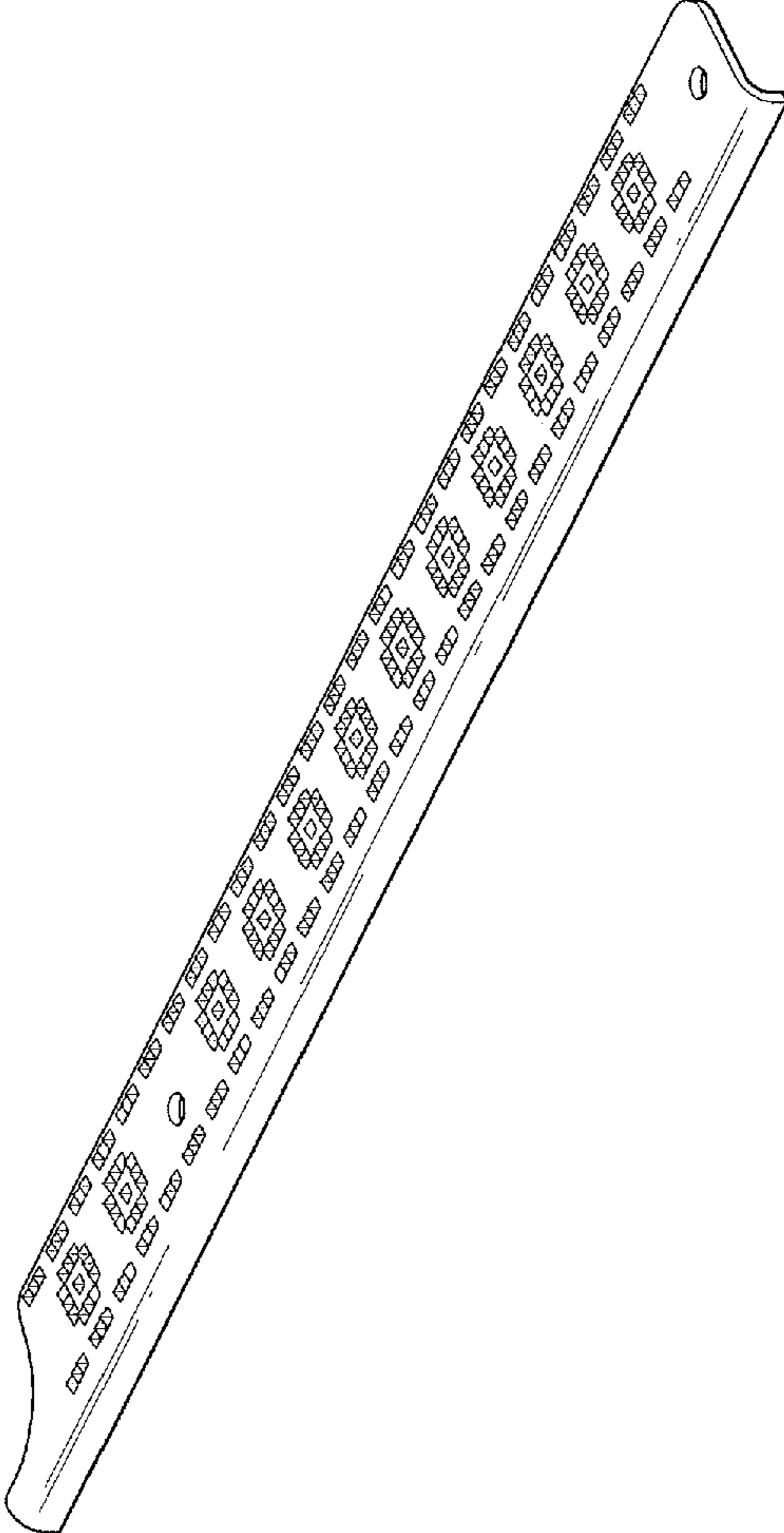
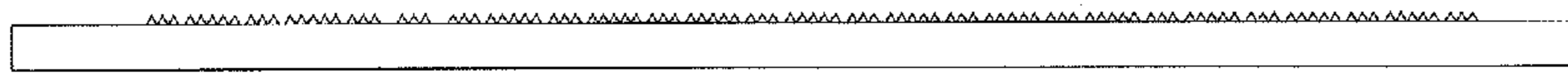

Fig. 1



**Fig. 2**



**Fig. 3**

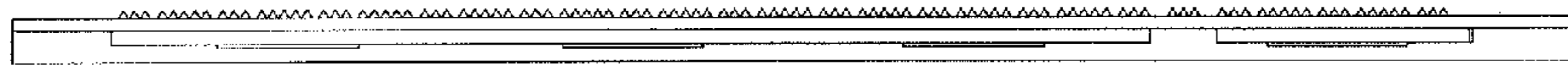

Fig. 4



Fig. 5

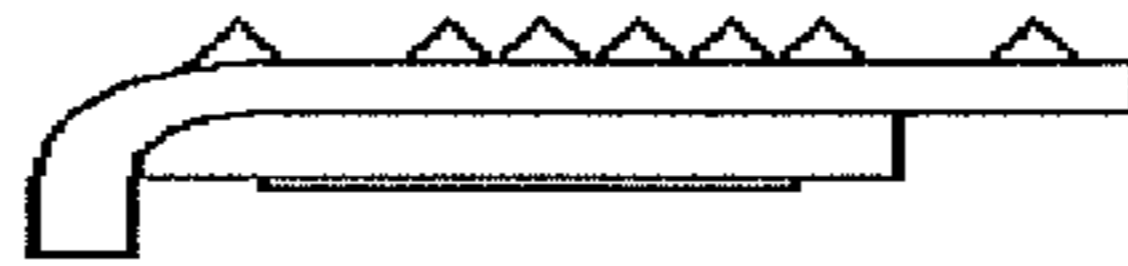

Fig. 6

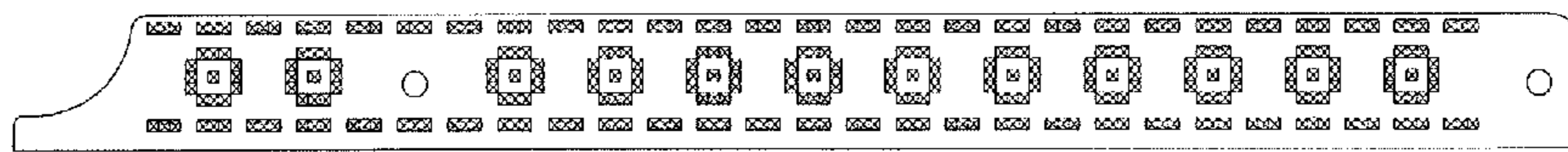
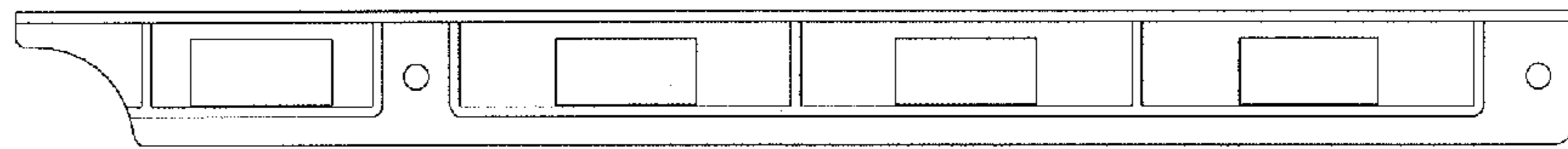

Fig. 7



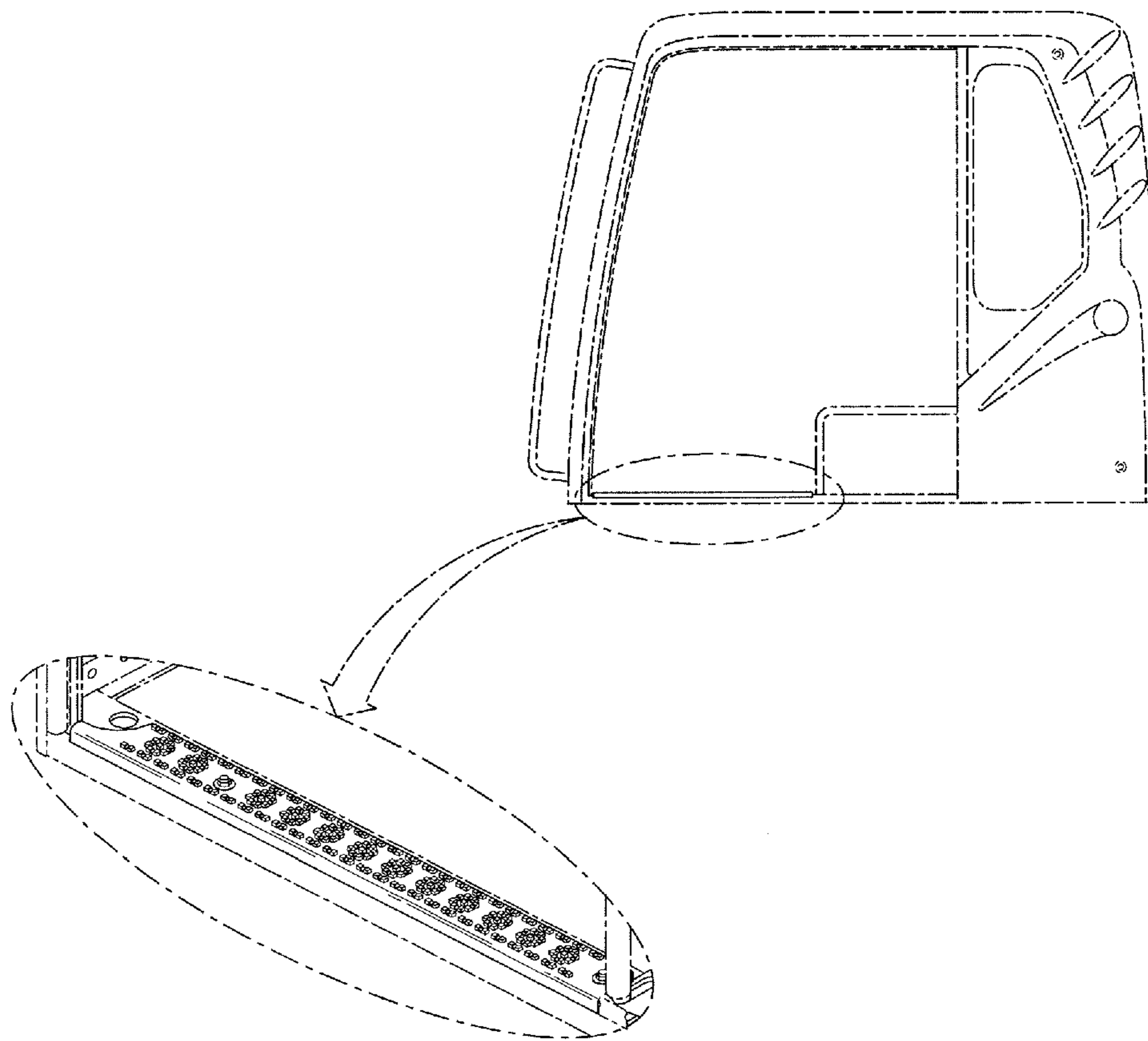

FIG. 8

UNITED STATES PATENT AND TRADEMARK OFFICE  
**CERTIFICATE OF CORRECTION**

PATENT NO. : D668,690 S  
APPLICATION NO. : 29/394074  
DATED : October 9, 2012  
INVENTOR(S) : Jang Hoon Bang

Page 1 of 1

It is certified that error appears in the above-identified patent and that said Letters Patent is hereby corrected as shown below:

Title Page, item (73), Assignee: "Consutruction" should read --Construction--.

Signed and Sealed this  
Twenty-seventh Day of November, 2012

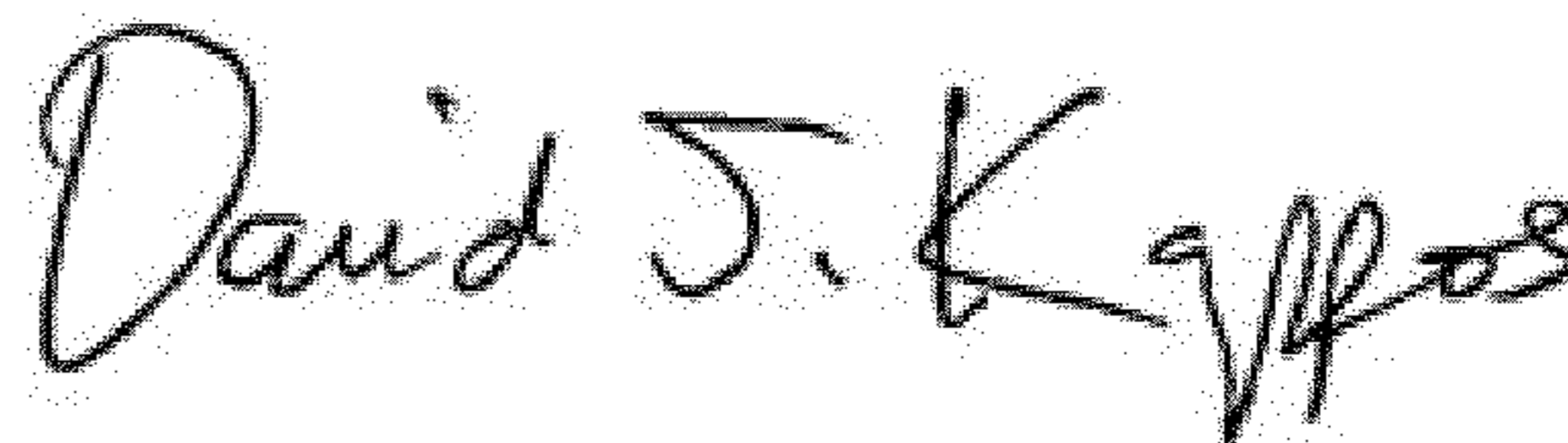
A handwritten signature in black ink that reads "David J. Kappos". The signature is written in a cursive, slightly slanted style.

David J. Kappos  
*Director of the United States Patent and Trademark Office*