

US00D668540S

(12) **United States Design Patent**  
**Lutzig**

(10) **Patent No.:** **US D668,540 S**

(45) **Date of Patent:** **\*\* Oct. 9, 2012**

(54) **PACKAGING CONTAINER**

(75) Inventor: **Bodo-Werner Lutzig**, Chavornay (CH)

(73) Assignee: **Philip Morris USA Inc.**, Richmond, VA (US)

(\*\*) Term: **14 Years**

(21) Appl. No.: **29/376,206**

(22) Filed: **Oct. 4, 2010**

**Related U.S. Application Data**

(62) Division of application No. 29/325,447, filed on Oct. 1, 2008, now Pat. No. Des. 624,816.

(30) **Foreign Application Priority Data**

Apr. 2, 2008 (EM) ..... 000911169

(51) **LOC (9) Cl.** ..... **09-03**

(52) **U.S. Cl.** ..... **D9/432**

(58) **Field of Classification Search** ..... D9/430-433,  
D9/414, 418, 420-423; D27/189; 206/278,  
206/297, 299, 457, 770, 737, 822; 229/100,  
229/101, 101.3, 106, 108, 108.1, 116.1, 116.3,  
229/116.5, 121, 122, 201, 213, 221, 222,  
229/227, 922, 939, 942, 87.08, 101.2, 193,  
229/195, 197

See application file for complete search history.

(56) **References Cited**

**U.S. PATENT DOCUMENTS**

1,358,875 A 11/1920 Reynolds  
2,788,827 A 4/1957 Banner  
3,018,878 A 1/1962 Watkins  
3,079,064 A 2/1963 Ringler  
4,119,196 A 10/1978 Flaherty  
D279,507 S 7/1985 Schechter et al.  
4,534,463 A 8/1985 Bouchard  
D282,444 S \* 2/1986 Yoshizawa ..... D9/432  
4,753,383 A 6/1988 Focke et al.  
D296,938 S 7/1988 Ameringen  
4,890,440 A 1/1990 Romagnoli  
D309,570 S \* 7/1990 Kinoshita ..... D9/418

D314,914 S \* 2/1991 Callinan ..... D9/432  
D315,638 S 3/1991 Pennell  
D319,587 S \* 9/1991 Lee ..... D9/432  
5,080,227 A 1/1992 Focke  
5,377,905 A 1/1995 Sigrist  
5,464,093 A 11/1995 Hogan  
5,478,011 A 12/1995 Pham  
5,487,468 A 1/1996 Sheahan  
5,513,752 A 5/1996 Gottlieb  
5,575,385 A 11/1996 Zona  
5,678,690 A 10/1997 Belvederi et al.  
D394,386 S 5/1998 Fischer  
D395,004 S 6/1998 Shamoon  
5,823,331 A 10/1998 Manservigi et al.  
5,924,627 A 7/1999 Wilder et al.  
6,015,084 A 1/2000 Mathieu et al.  
D441,497 S 5/2001 Focke et al.  
6,311,834 B1 11/2001 Focke et al.  
6,370,846 B1 4/2002 Schoch et al.  
6,612,429 B2 9/2003 Dennen  
6,719,131 B1 4/2004 Focke et al.  
6,742,651 B1 6/2004 Focke et al.  
6,941,728 B1 9/2005 Bray et al.  
D519,673 S 4/2006 Bray et al.  
7,093,711 B2 8/2006 Draghetti et al.  
D538,643 S 3/2007 Babbino et al.  
7,395,924 B2 7/2008 Tambo  
7,428,967 B2 9/2008 Petrucci et al.  
D578,385 S 10/2008 Ancona  
D579,149 S 10/2008 Bertuzzi et al.  
D579,325 S 10/2008 Bray et al.  
D580,751 S \* 11/2008 Blick ..... D9/432  
7,455,176 B2 11/2008 Focke et al.  
D582,264 S 12/2008 Snyder  
D583,096 S 12/2008 Conti et al.  
D591,899 S 5/2009 Bray et al.  
7,537,113 B2 5/2009 Tambo  
D625,179 S \* 10/2010 Gibson ..... D9/423  
7,946,459 B1 \* 5/2011 Cheitman ..... 224/600  
D643,747 S \* 8/2011 Rye et al. .... D9/721  
D649,067 S \* 11/2011 Birdwell et al. .... D9/721  
2002/0190110 A1 12/2002 Polloni et al.  
2003/0106928 A1 6/2003 Li Vigni et al.  
2005/0218200 A1 10/2005 Focke et al.  
2005/0252796 A1 11/2005 Sendo  
2006/0011498 A1 1/2006 Giannini et al.  
2006/0054518 A1 3/2006 Focke et al.  
2006/0191986 A1 8/2006 Focke et al.  
2006/0208050 A1 9/2006 Petrucci et al.  
2008/0029411 A1 2/2008 Polloni et al.  
2008/0190791 A1 8/2008 Ghini et al.

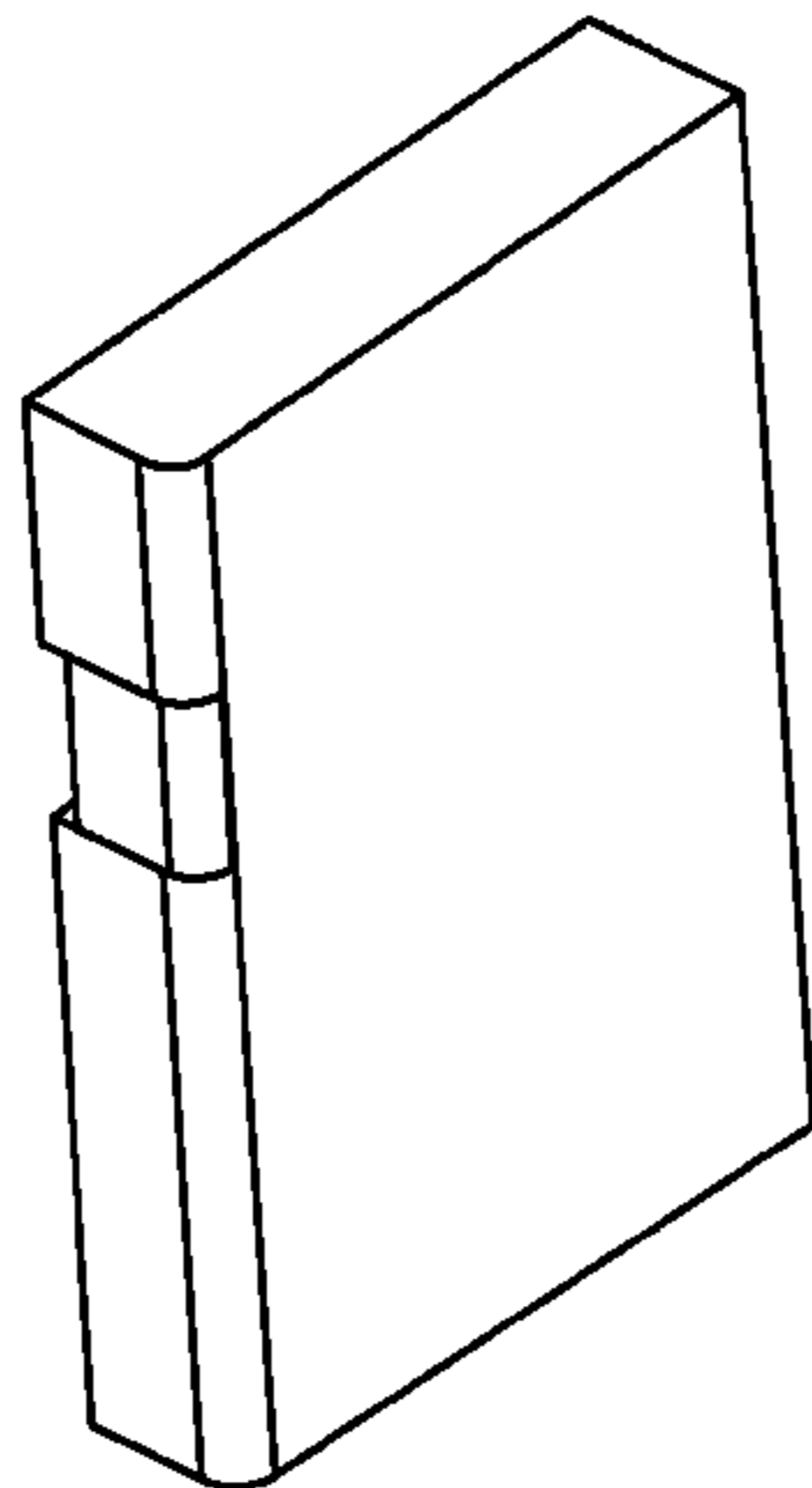

2008/0283427 A1 11/2008 Polloni et al.  
 2009/0078599 A1 3/2009 Tanbo  
 2011/0147243 A1\* 6/2011 Chatelain ..... 206/267

FOREIGN PATENT DOCUMENTS

EM 382080-0001-0014 8/2005

\* cited by examiner

*Primary Examiner* — Karen S Acker  
 (74) *Attorney, Agent, or Firm* — Buchanan Ingersoll & Rooney PC

(57) **CLAIM**  
 The ornamental design for a packaging container, as shown and described.

**DESCRIPTION**

FIG. 1 is a front perspective view of a packaging container according to a first embodiment of my new design.  
 FIG. 2 is a bottom plan view thereof.  
 FIG. 3 is a right side elevational view thereof.  
 FIG. 4 is a front elevational thereof.  
 FIG. 5 is a top plan view thereof.  
 FIG. 6 is a left side elevational view thereof.  
 FIG. 7 is a rear elevational view thereof.  
 FIG. 8 is a front perspective view of a packaging container according to a second embodiment of my new design.  
 FIG. 9 is a bottom plan view thereof.  
 FIG. 10 is a right side elevational view thereof.  
 FIG. 11 is a front elevational thereof.  
 FIG. 12 is a top plan view thereof.  
 FIG. 13 is a left side elevational view thereof.  
 FIG. 14 is a rear elevational view thereof.  
 FIG. 15 is a front perspective view of a packaging container according to a third embodiment of my new design.  
 FIG. 16 is a bottom plan view thereof.  
 FIG. 17 is a right side elevational view thereof.  
 FIG. 18 is a front elevational thereof.  
 FIG. 19 is a top plan view thereof.  
 FIG. 20 is a left side elevational view thereof.  
 FIG. 21 is a rear elevational view thereof.  
 FIG. 22 is a front perspective view of a packaging container according to a fourth embodiment of my new design.  
 FIG. 23 is a bottom plan view thereof.  
 FIG. 24 is a right side elevational view thereof.  
 FIG. 25 is a front elevational thereof.  
 FIG. 26 is a top plan view thereof.  
 FIG. 27 is a left side elevational view thereof.  
 FIG. 28 is a rear elevational view thereof.  
 FIG. 29 is a front perspective view of a packaging container according to a fifth embodiment of my new design.  
 FIG. 30 is a bottom plan view thereof.  
 FIG. 31 is a right side elevational view thereof.  
 FIG. 32 is a front elevational thereof.  
 FIG. 33 is a top plan view thereof.  
 FIG. 34 is a left side elevational view thereof.  
 FIG. 35 is a rear elevational view thereof.  
 FIG. 36 is a front perspective view of a packaging container according to a sixth embodiment of my new design.  
 FIG. 37 is a bottom plan view thereof.  
 FIG. 38 is a right side elevational view thereof.  
 FIG. 39 is a front elevational thereof.  
 FIG. 40 is a top plan view thereof.  
 FIG. 41 is a left side elevational view thereof.  
 FIG. 42 is a rear elevational view thereof.

FIG. 43 is a front perspective view of a packaging container according to a seventh embodiment of my new design.  
 FIG. 44 is a bottom plan view thereof.  
 FIG. 45 is a right side elevational view thereof.  
 FIG. 46 is a front elevational thereof.  
 FIG. 47 is a top plan view thereof.  
 FIG. 48 is a left side elevational view thereof.  
 FIG. 49 is a rear elevational view thereof.  
 FIG. 50 is a front perspective view of a packaging container according to an eighth embodiment of my new design.  
 FIG. 51 is a bottom plan view thereof.  
 FIG. 52 is a right side elevational view thereof.  
 FIG. 53 is a front elevational thereof.  
 FIG. 54 is a top plan view thereof.  
 FIG. 55 is a left side elevational view thereof.  
 FIG. 56 is a rear elevational view thereof.  
 FIG. 57 is a front perspective view of a packaging container according to a ninth embodiment of my new design.  
 FIG. 58 is a bottom plan view thereof.  
 FIG. 59 is a right side elevational view thereof.  
 FIG. 60 is a front elevational thereof.  
 FIG. 61 is a top plan view thereof.  
 FIG. 62 is a left side elevational view thereof.  
 FIG. 63 is a rear elevational view thereof.  
 FIG. 64 is a front perspective view of a packaging container according to a tenth embodiment of my new design.  
 FIG. 65 is a bottom plan view thereof.  
 FIG. 66 is a right side elevational view thereof.  
 FIG. 67 is a front elevational thereof.  
 FIG. 68 is a top plan view thereof.  
 FIG. 69 is a left side elevational view thereof.  
 FIG. 70 is a rear elevational view thereof.  
 FIG. 71 is a front perspective view of a packaging container according to an eleventh embodiment of my new design.  
 FIG. 72 is a bottom plan view thereof.  
 FIG. 73 is a right side elevational view thereof.  
 FIG. 74 is a front elevational thereof.  
 FIG. 75 is a top plan view thereof.  
 FIG. 76 is a left side elevational view thereof.  
 FIG. 77 is a rear elevational view thereof.  
 FIG. 78 is a front perspective view of a packaging container according to a twelfth embodiment of my new design.  
 FIG. 79 is a bottom plan view thereof.  
 FIG. 80 is a right side elevational view thereof.  
 FIG. 81 is a front elevational thereof.  
 FIG. 82 is a top plan view thereof.  
 FIG. 83 is a left side elevational view thereof.  
 FIG. 84 is a rear elevational view thereof.  
 FIG. 85 is a front perspective view of a packaging container according to a thirteenth embodiment of my new design.  
 FIG. 86 is a bottom plan view thereof.  
 FIG. 87 is a right side elevational view thereof.  
 FIG. 88 is a front elevational thereof.  
 FIG. 89 is a top plan view thereof.  
 FIG. 90 is a left side elevational view thereof.  
 FIG. 91 is a rear elevational view thereof.  
 FIG. 92 is a front perspective view of a packaging container according to a fourteenth embodiment of my new design.  
 FIG. 93 is a bottom plan view thereof.  
 FIG. 94 is a right side elevational view thereof.  
 FIG. 95 is a front elevational thereof.  
 FIG. 96 is a top plan view thereof.  
 FIG. 97 is a left side elevational view thereof.  
 FIG. 98 is a rear elevational view thereof.

FIG. 99 is a front perspective view of a packaging container according to a fifteenth embodiment of my new design.  
FIG. 100 is a bottom plan view thereof.  
FIG. 101 is a right side elevational view thereof.  
FIG. 102 is a front elevational thereof.  
FIG. 103 is a top plan view thereof.  
FIG. 104 is a left side elevational view thereof.  
FIG. 105 is a rear elevational view thereof.  
FIG. 106 is a front perspective view of a packaging container according to a sixteenth embodiment of my new design.  
FIG. 107 is a bottom plan view thereof.  
FIG. 108 is a right side elevational view thereof.  
FIG. 109 is a front elevational thereof.  
FIG. 110 is a top plan view thereof.  
FIG. 111 is a left side elevational view thereof.  
FIG. 112 is a rear elevational view thereof.  
FIG. 113 is a front perspective view of a packaging container according to a seventeenth embodiment of my new design.  
FIG. 114 a bottom plan view thereof.  
FIG. 115 a right side elevational view thereof.  
FIG. 116 a front elevational thereof.  
FIG. 117 a top plan view thereof.  
FIG. 118 a left side elevational view thereof.  
FIG. 119 a rear elevational view thereof.  
FIG. 120 is a front perspective view of a packaging container according to an eighteenth embodiment of my new design.  
FIG. 121 is a bottom plan view thereof.  
FIG. 122 is a right side elevational view thereof.  
FIG. 123 is a front elevational thereof.  
FIG. 124 is a top plan view thereof.  
FIG. 125 is a left side elevational view thereof.  
FIG. 126 is a rear elevational view thereof.  
FIG. 127 is a front perspective view of a packaging container according to a nineteenth embodiment of my new design.  
FIG. 128 is a bottom plan view thereof.  
FIG. 129 is a right side elevational view thereof.  
FIG. 130 is a front elevational thereof.  
FIG. 131 is a top plan view thereof.  
FIG. 132 is a left side elevational view thereof.  
FIG. 133 is a rear elevational view thereof.  
FIG. 134 is a front perspective view of a packaging container according to a twentieth embodiment of my new design.  
FIG. 135 is a bottom plan view thereof.  
FIG. 136 is a right side elevational view thereof.  
FIG. 137 is a front elevational thereof.  
FIG. 138 is a top plan view thereof.  
FIG. 139 is a left side elevational view thereof.  
FIG. 140 is a rear elevational view thereof.

FIG. 141 is a front perspective view of a packaging container according to a twenty-first embodiment of my new design.  
FIG. 142 is a bottom plan view thereof.  
FIG. 143 is a right side elevational view thereof.  
FIG. 144 is a front elevational thereof.  
FIG. 145 is a top plan view thereof.  
FIG. 146 is a left side elevational view thereof.  
FIG. 147 is a rear elevational view thereof.  
FIG. 148 is a front perspective view of a packaging container according to a twenty-second embodiment of my new design.  
FIG. 149 is a bottom plan view thereof.  
FIG. 150 is a right side elevational view thereof.  
FIG. 151 is a front elevational thereof.  
FIG. 152 is a top plan view thereof.  
FIG. 153 is a left side elevational view thereof.  
FIG. 154 is a rear elevational view thereof.  
FIG. 155 is a front perspective view of a packaging container according to a twenty-third embodiment of my new design.  
FIG. 156 is a bottom plan view thereof.  
FIG. 157 is a right side elevational view thereof.  
FIG. 158 is a front elevational thereof.  
FIG. 159 is a top plan view thereof.  
FIG. 160 is a left side elevational view thereof.  
FIG. 161 is a rear elevational view thereof.  
FIG. 162 is a front perspective view of a packaging container according to a twenty-fourth embodiment of my new design.  
FIG. 163 is a bottom plan view thereof.  
FIG. 164 is a right side elevational view thereof.  
FIG. 165 is a front elevational thereof.  
FIG. 166 is a top plan view thereof.  
FIG. 167 is a left side elevational view thereof.  
FIG. 168 is a rear elevational view thereof.  
FIG. 169 is a front perspective view of a packaging container according to a twenty-fifth embodiment of my new design.  
FIG. 170 is a bottom plan view thereof.  
FIG. 171 is a right side elevational view thereof.  
FIG. 172 is a front elevational thereof.  
FIG. 173 is a top plan view thereof.  
FIG. 174 is a left side elevational view thereof.  
FIG. 175 is a rear elevational view thereof.  
FIG. 176 is a front perspective view of a packaging container according to a twenty-sixth embodiment of my new design.  
FIG. 177 is a bottom plan view thereof.  
FIG. 178 is a right side elevational view thereof.  
FIG. 179 is a front elevational thereof.  
FIG. 180 is a top plan view thereof.  
FIG. 181 is a left side elevational view thereof; and,  
FIG. 182 is a rear elevational view thereof.

**1 Claim, 52 Drawing Sheets**

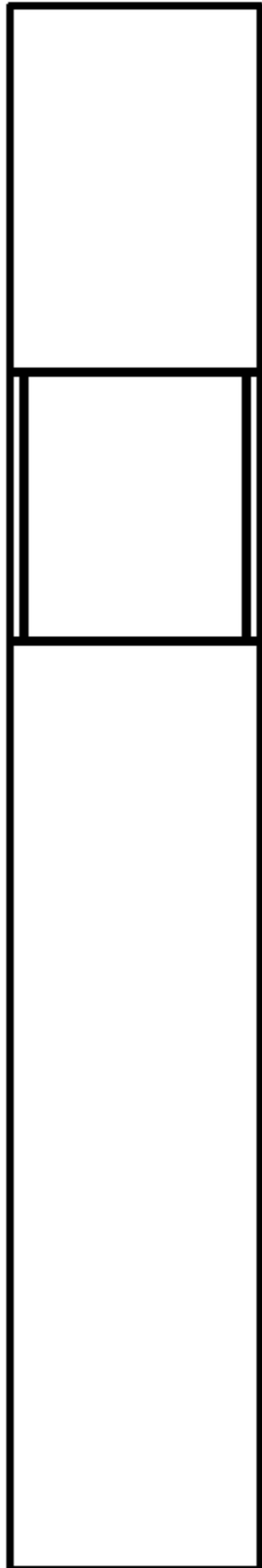

FIG. 6

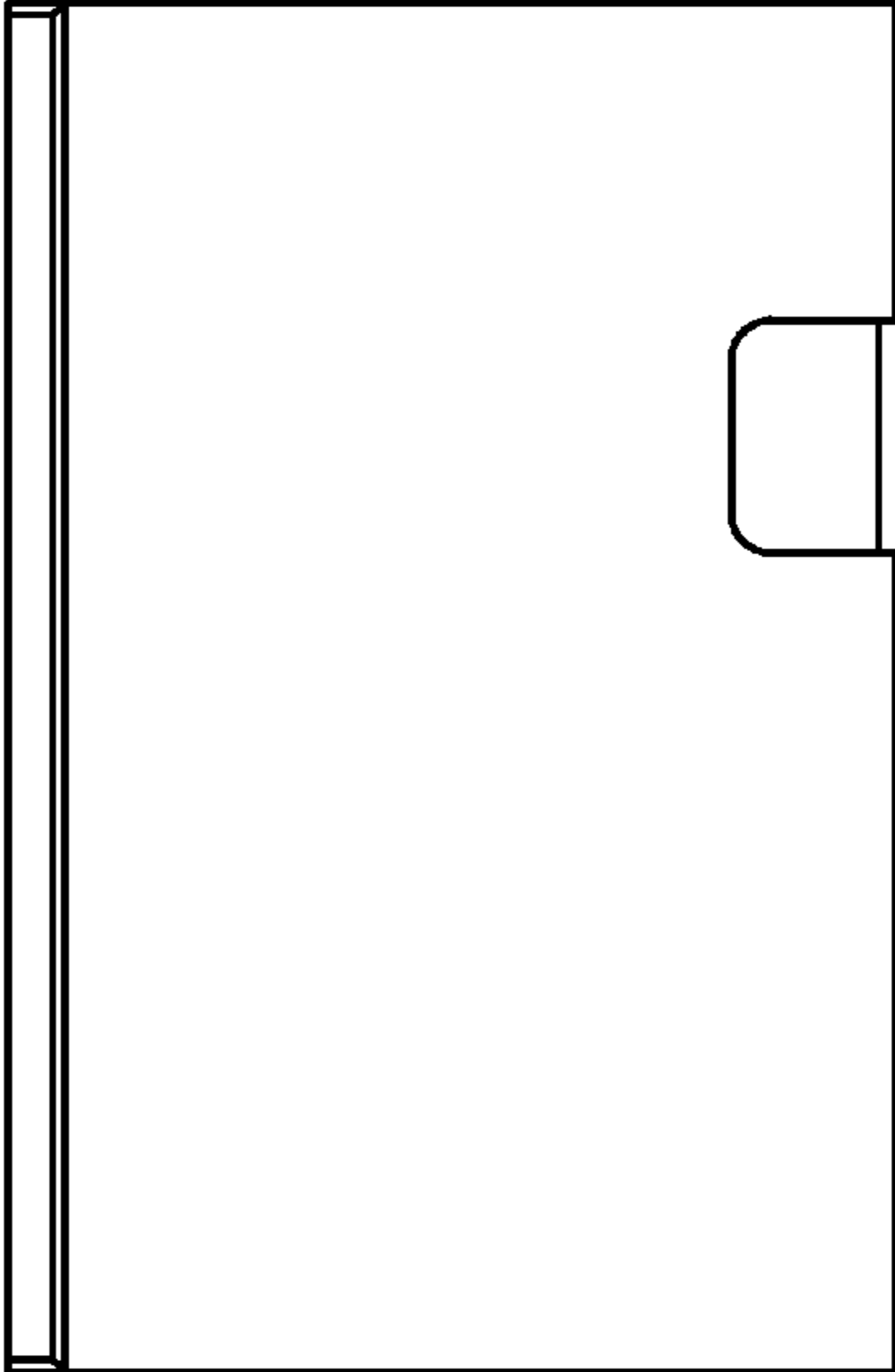

FIG. 7

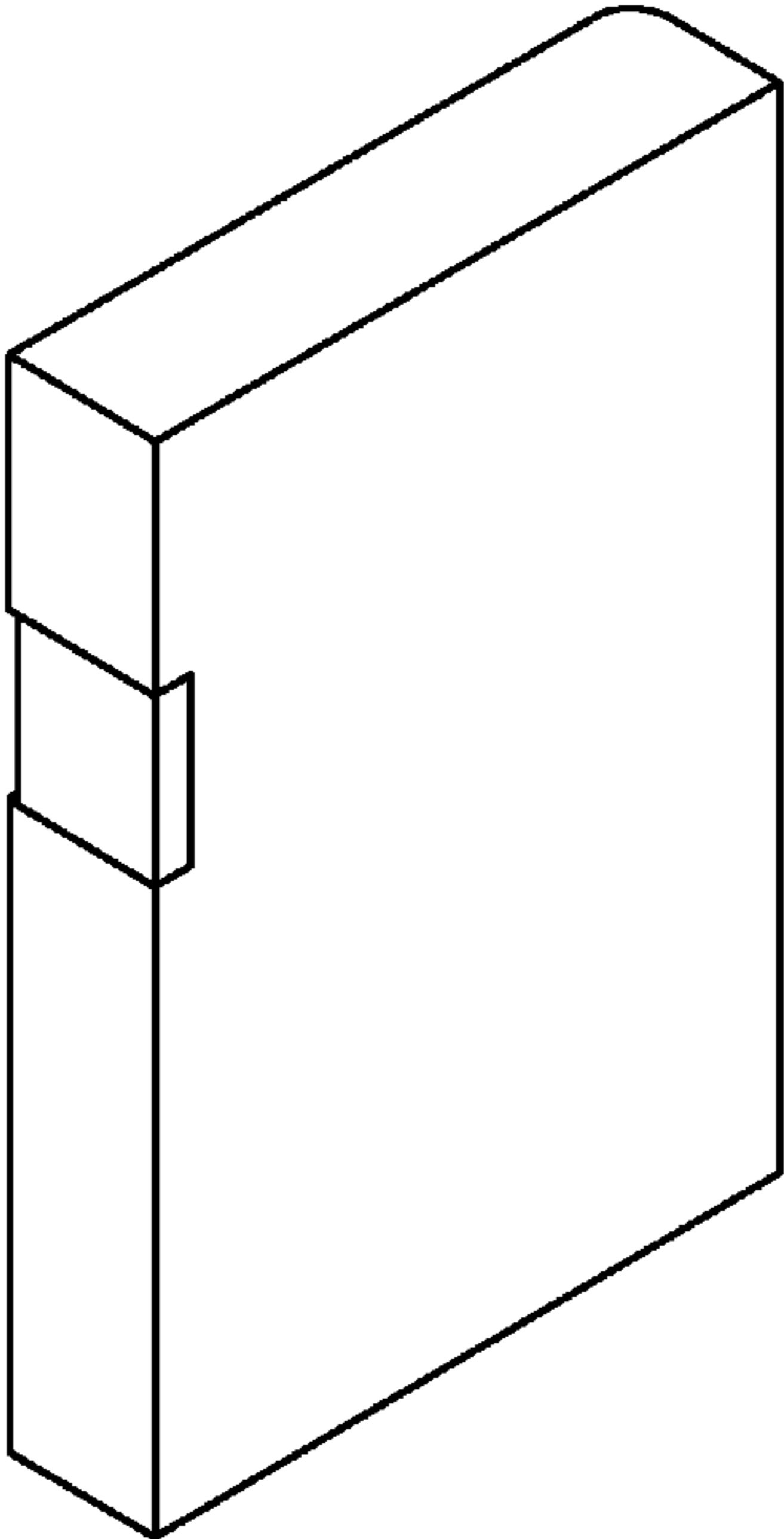

FIG. 1



FIG. 2

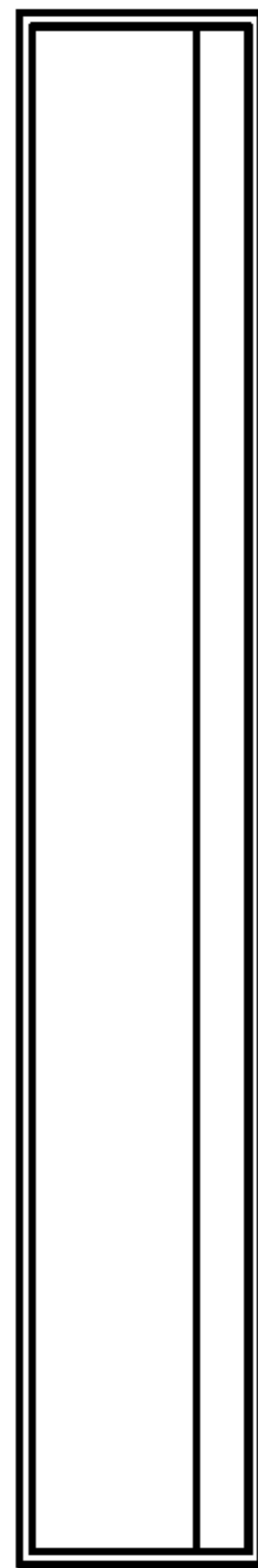

FIG. 3

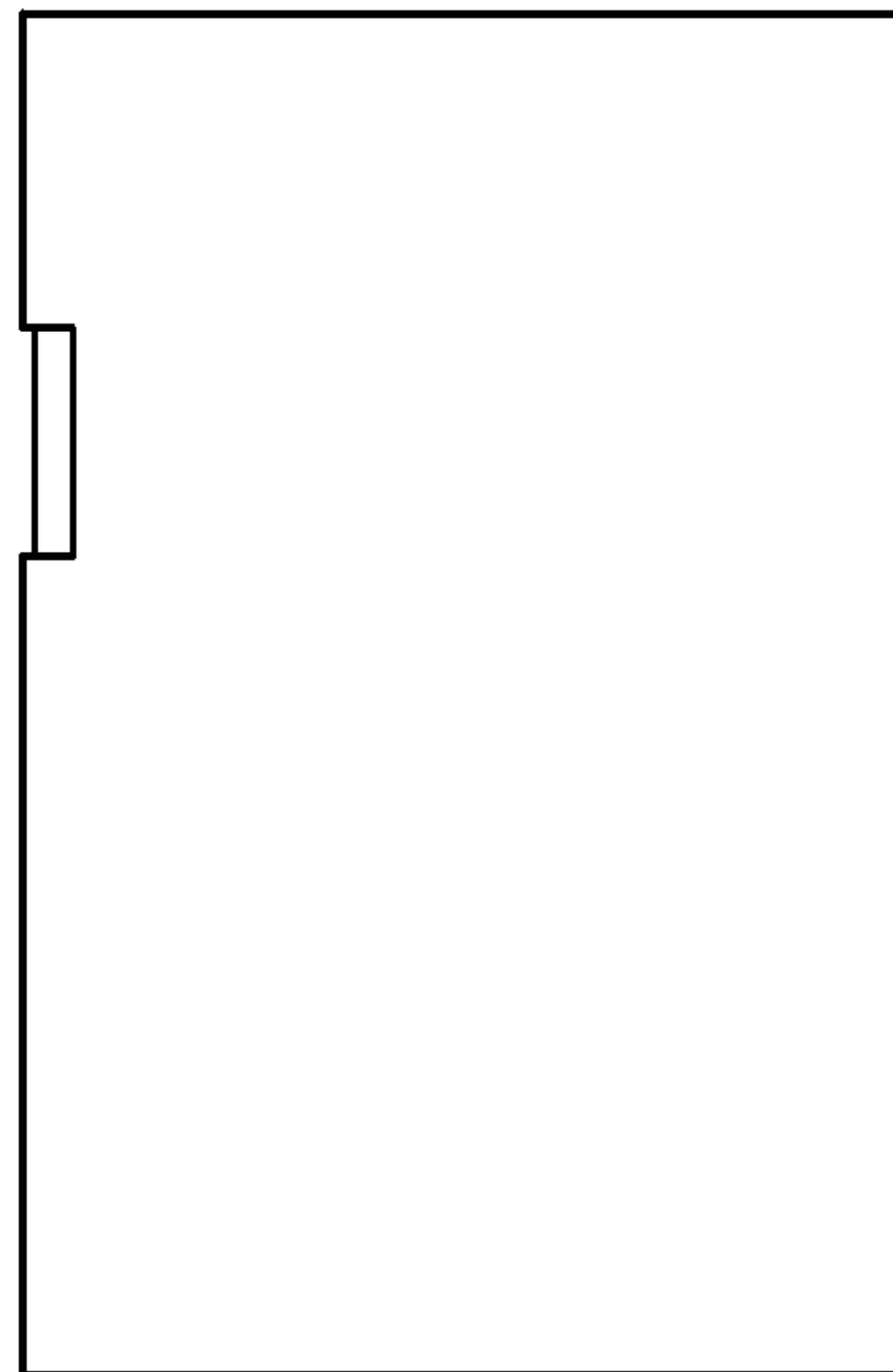

FIG. 4



FIG. 5

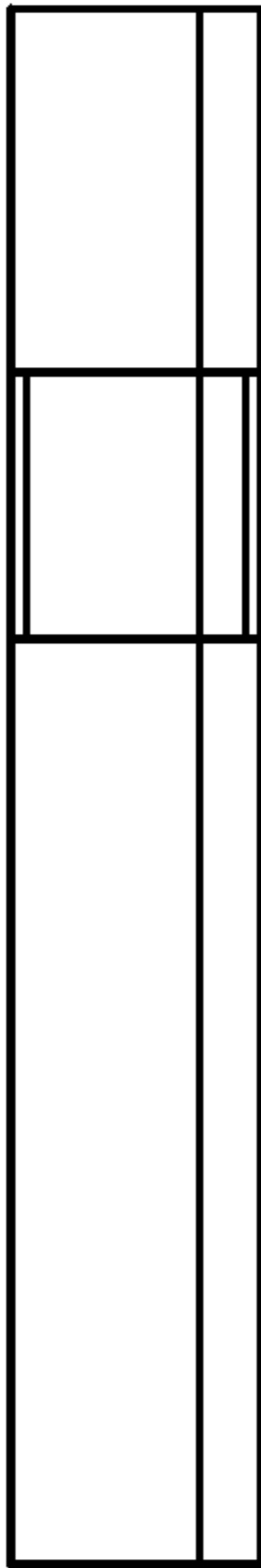

FIG. 13

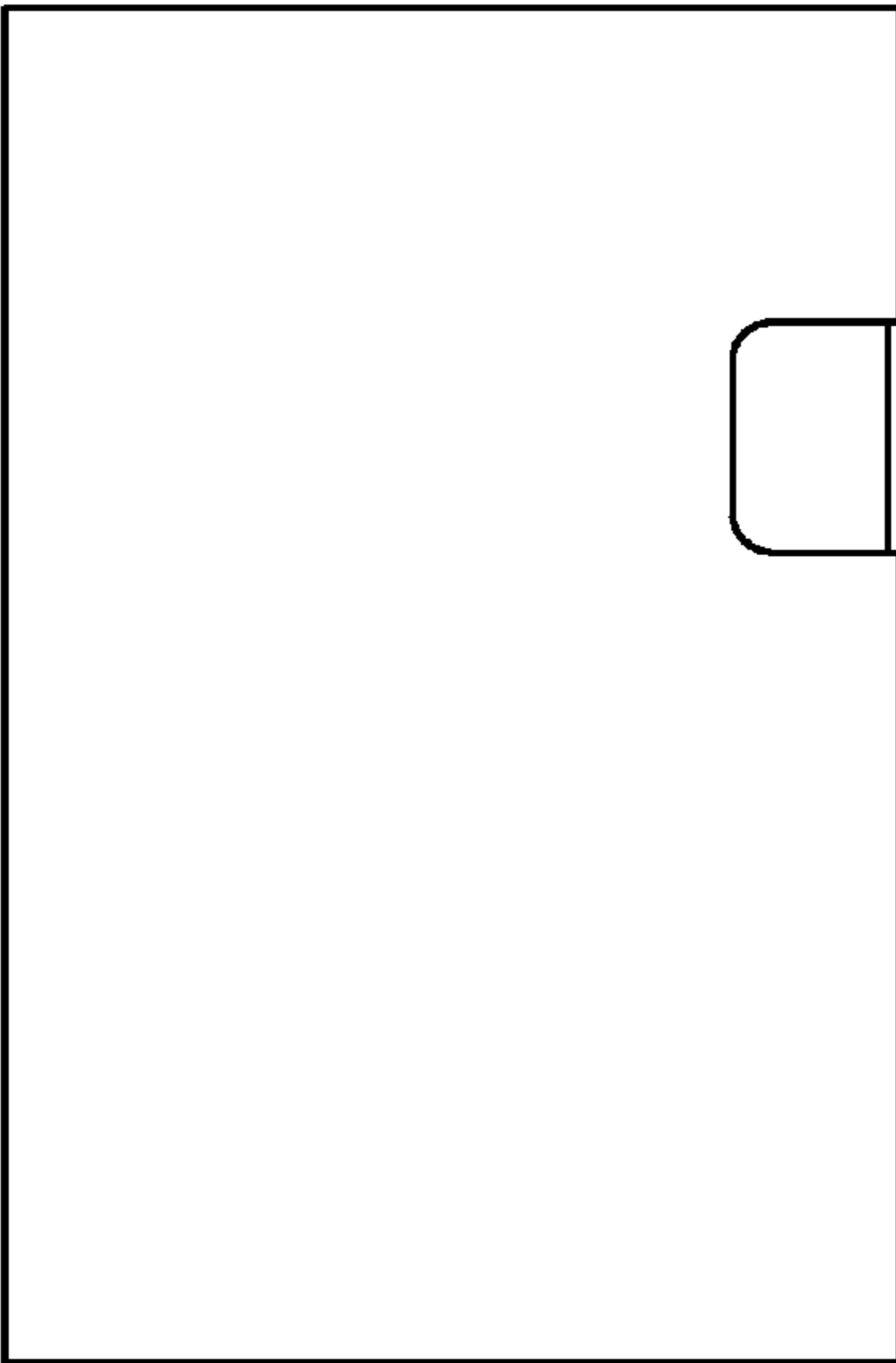

FIG. 14

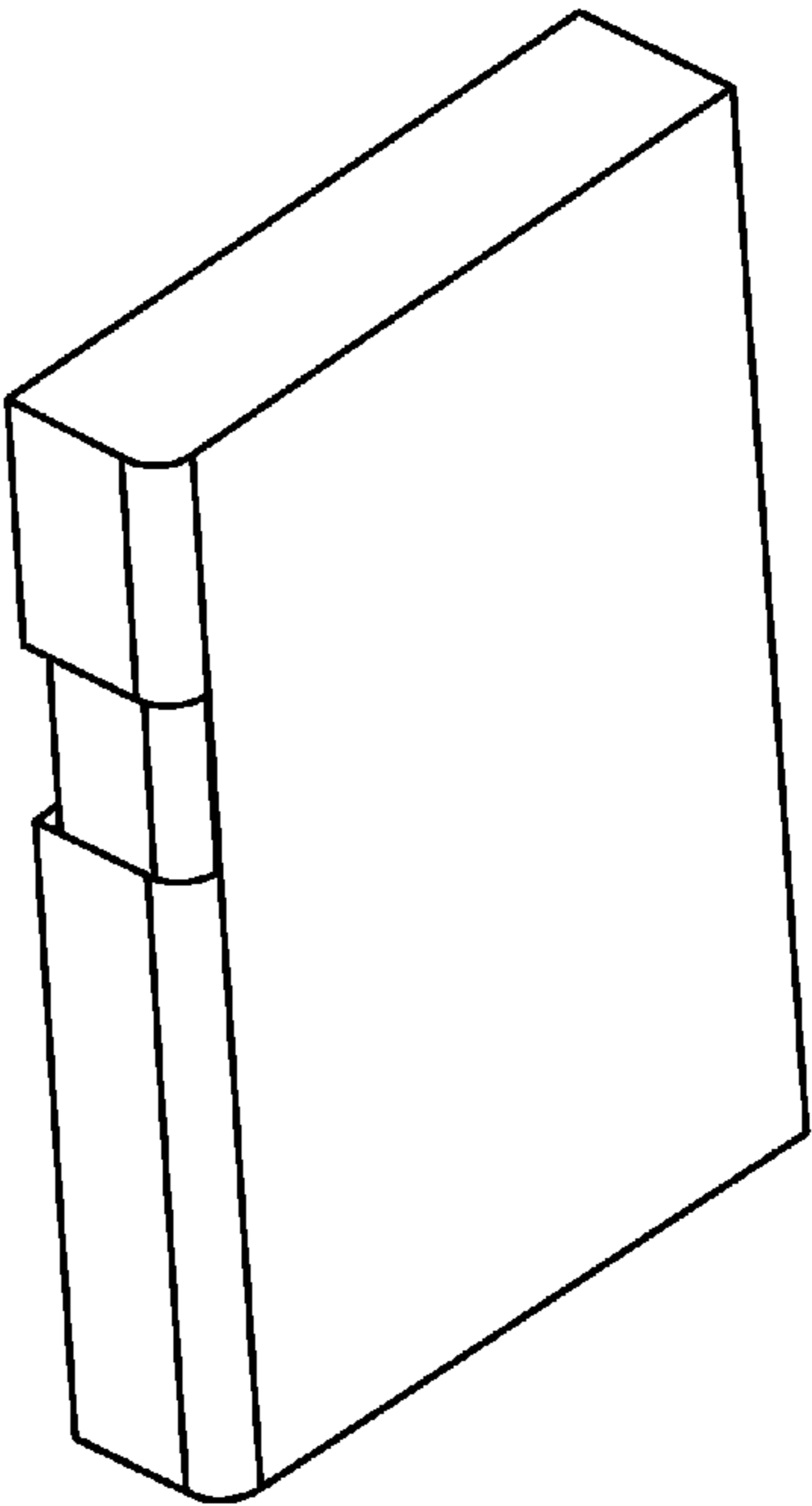

FIG. 8



FIG. 9

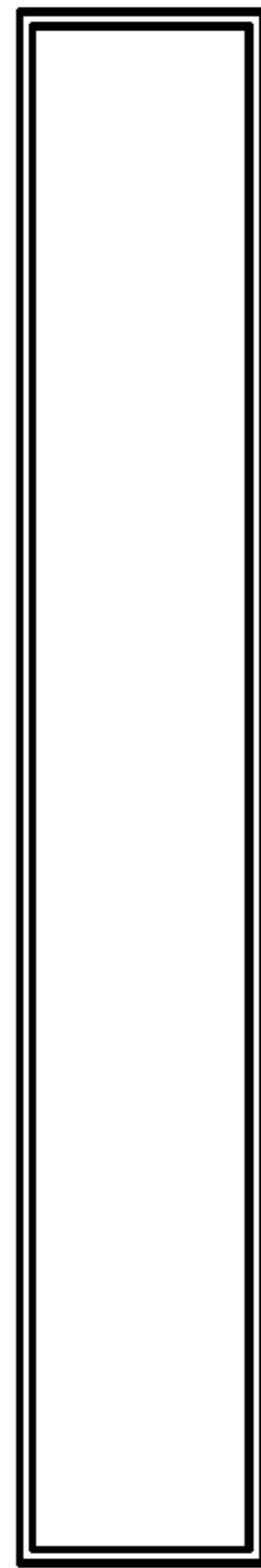

FIG. 10

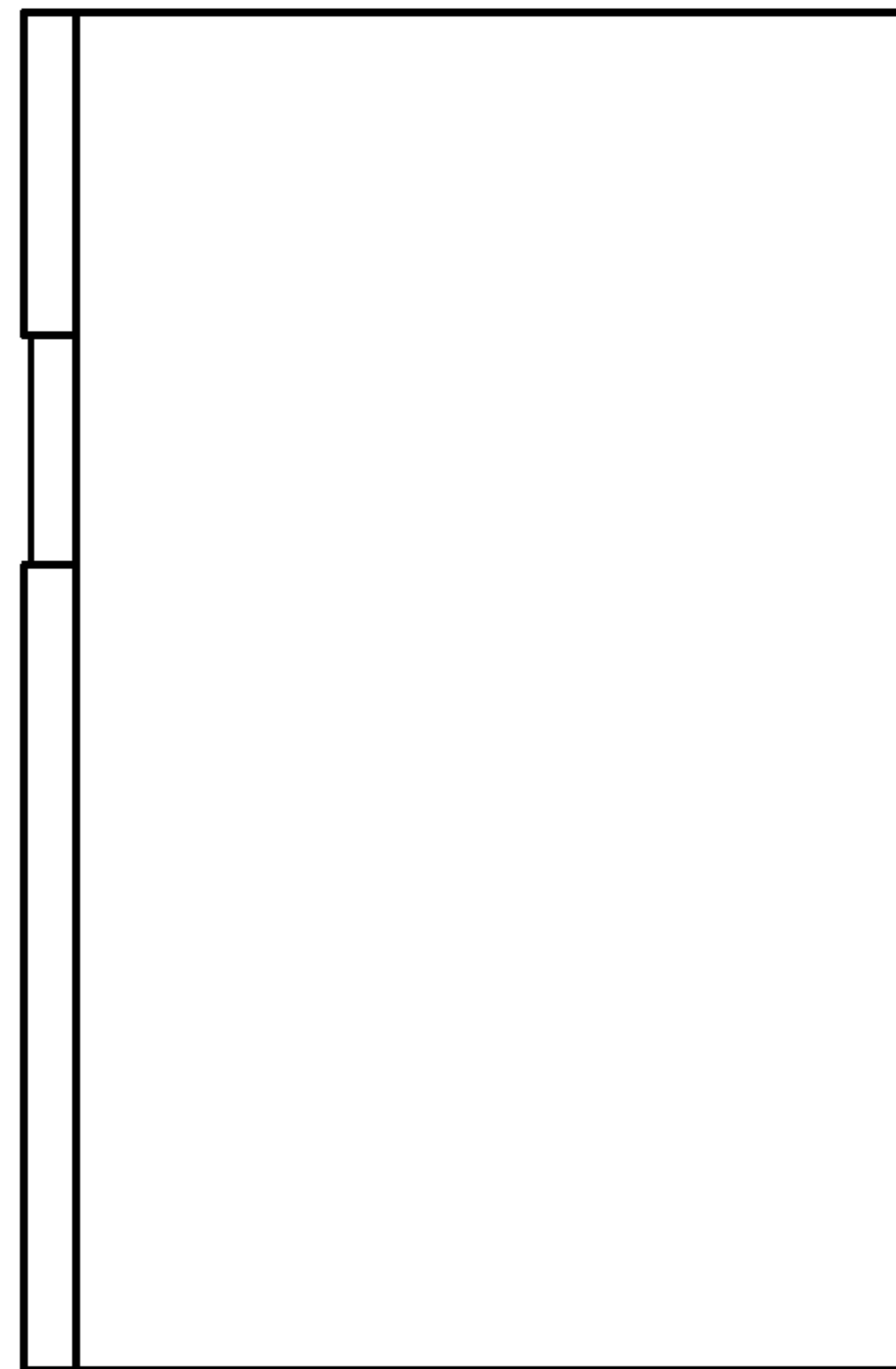

FIG. 11



FIG. 12

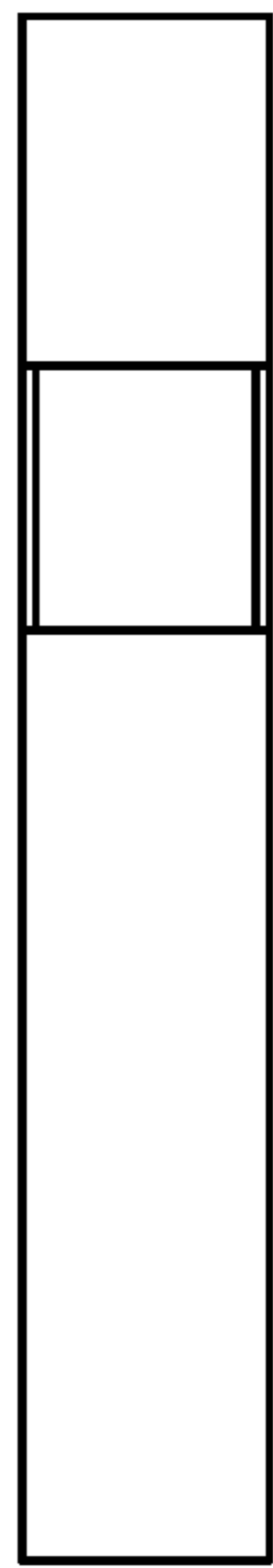

FIG. 20

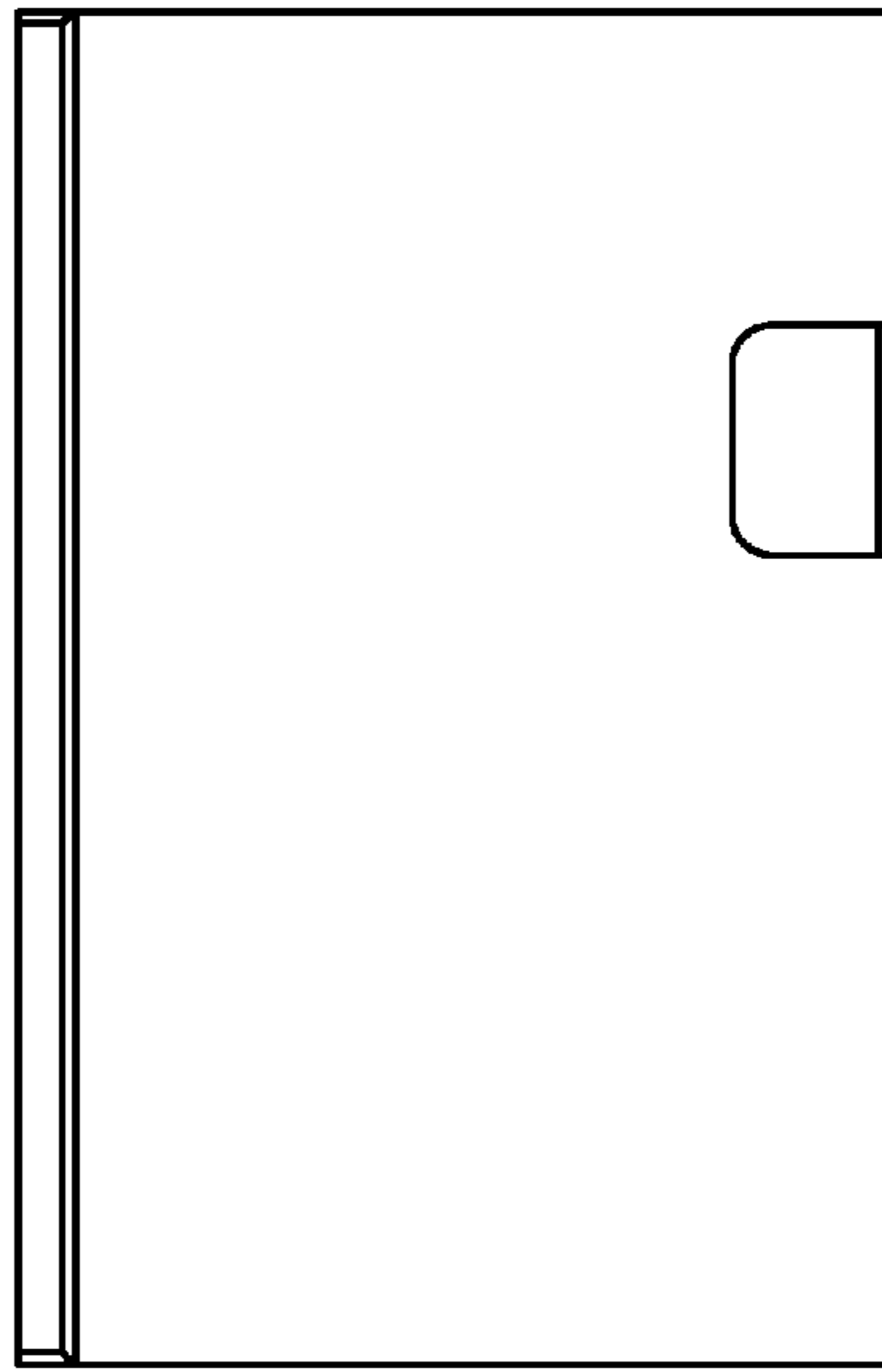

FIG. 21

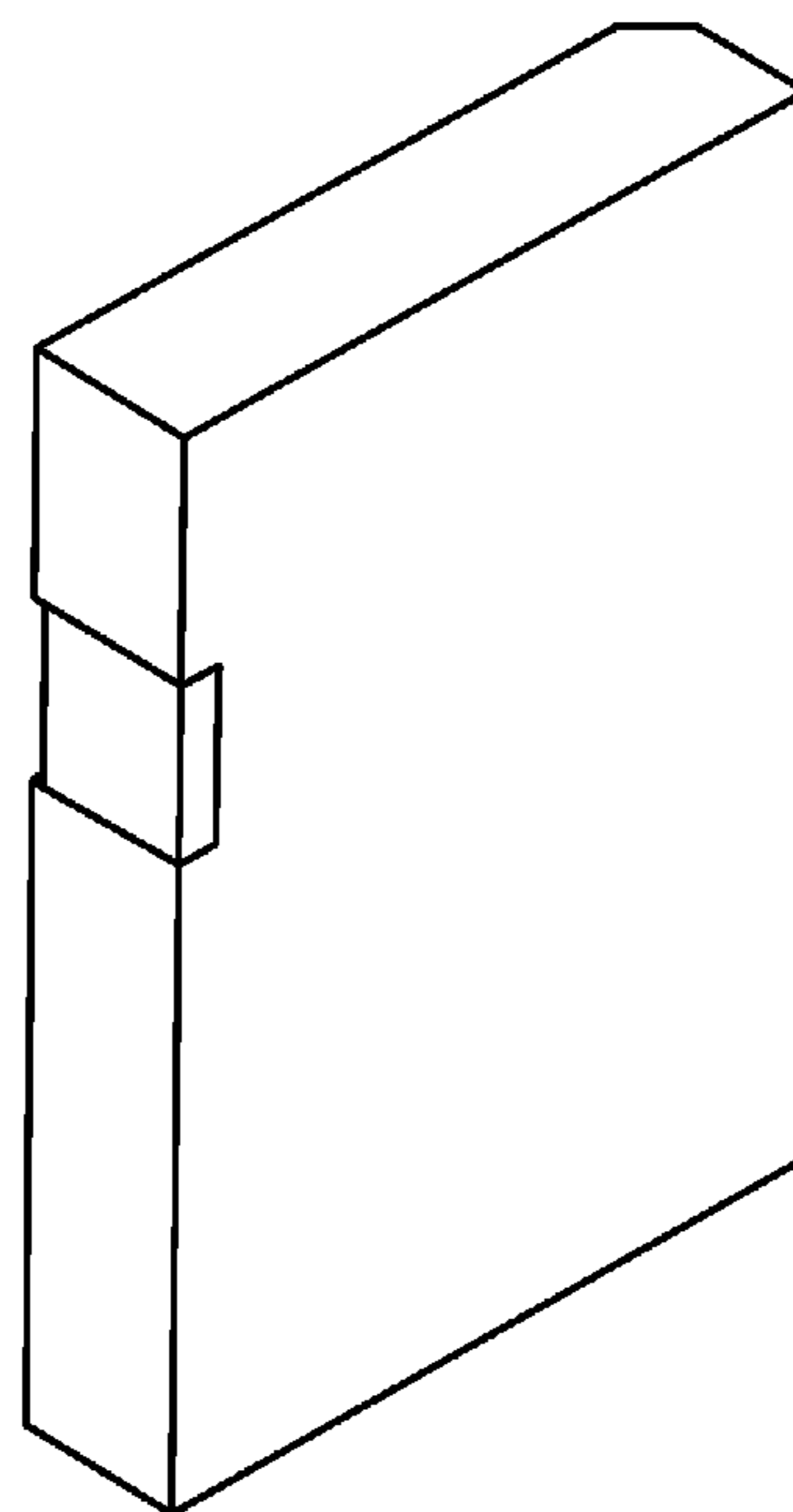

FIG. 15





FIG. 16

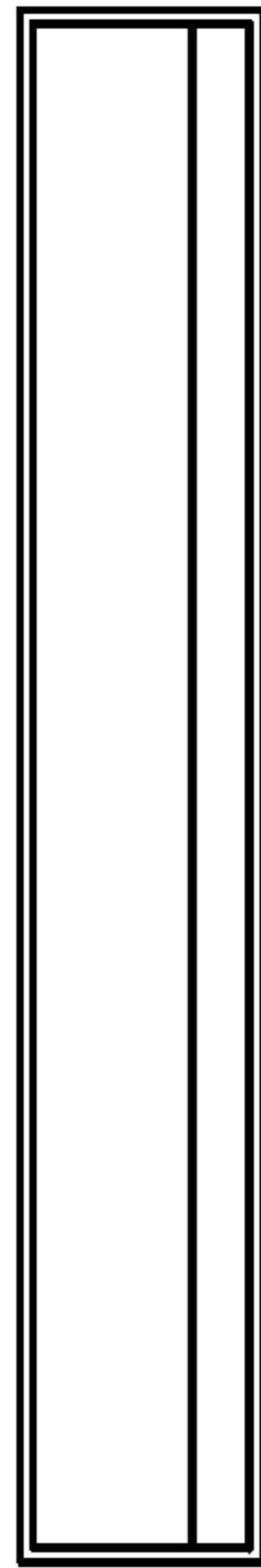

FIG. 17

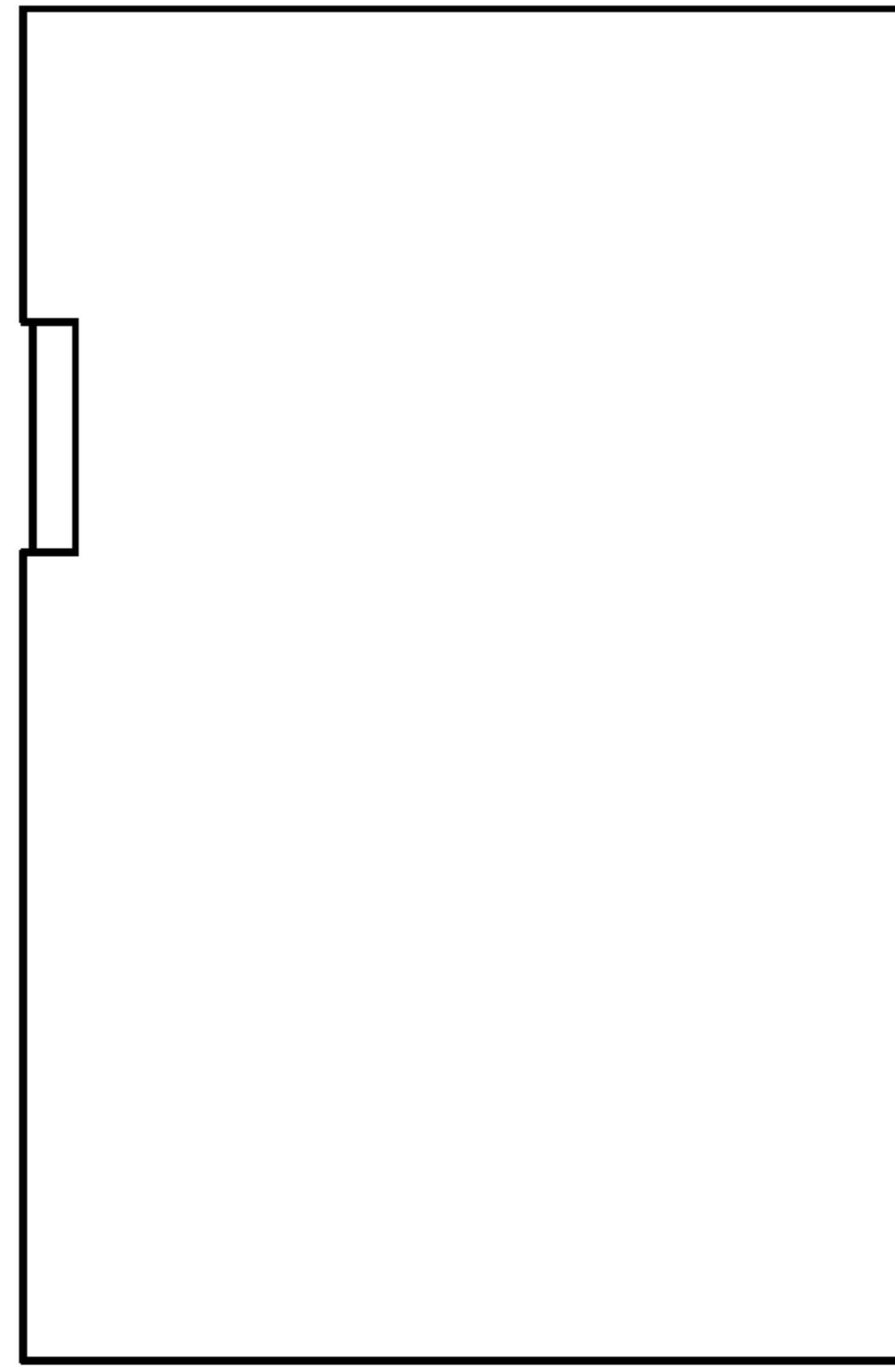

FIG. 18



FIG. 19

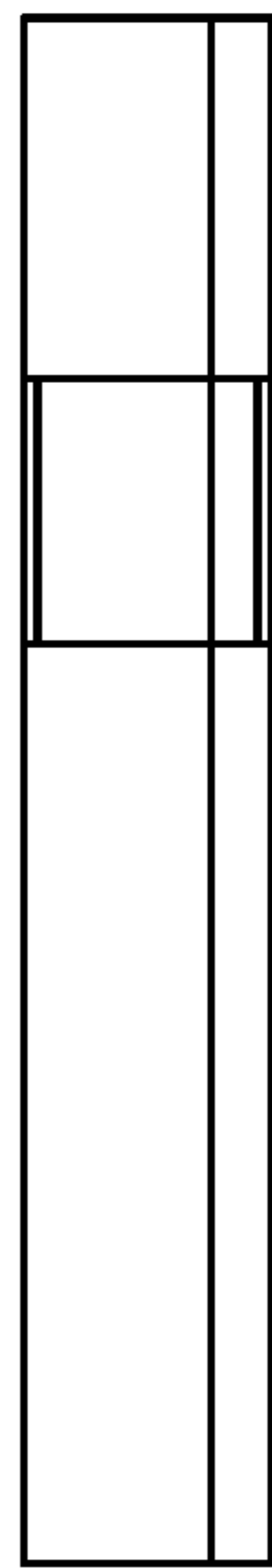

FIG. 27

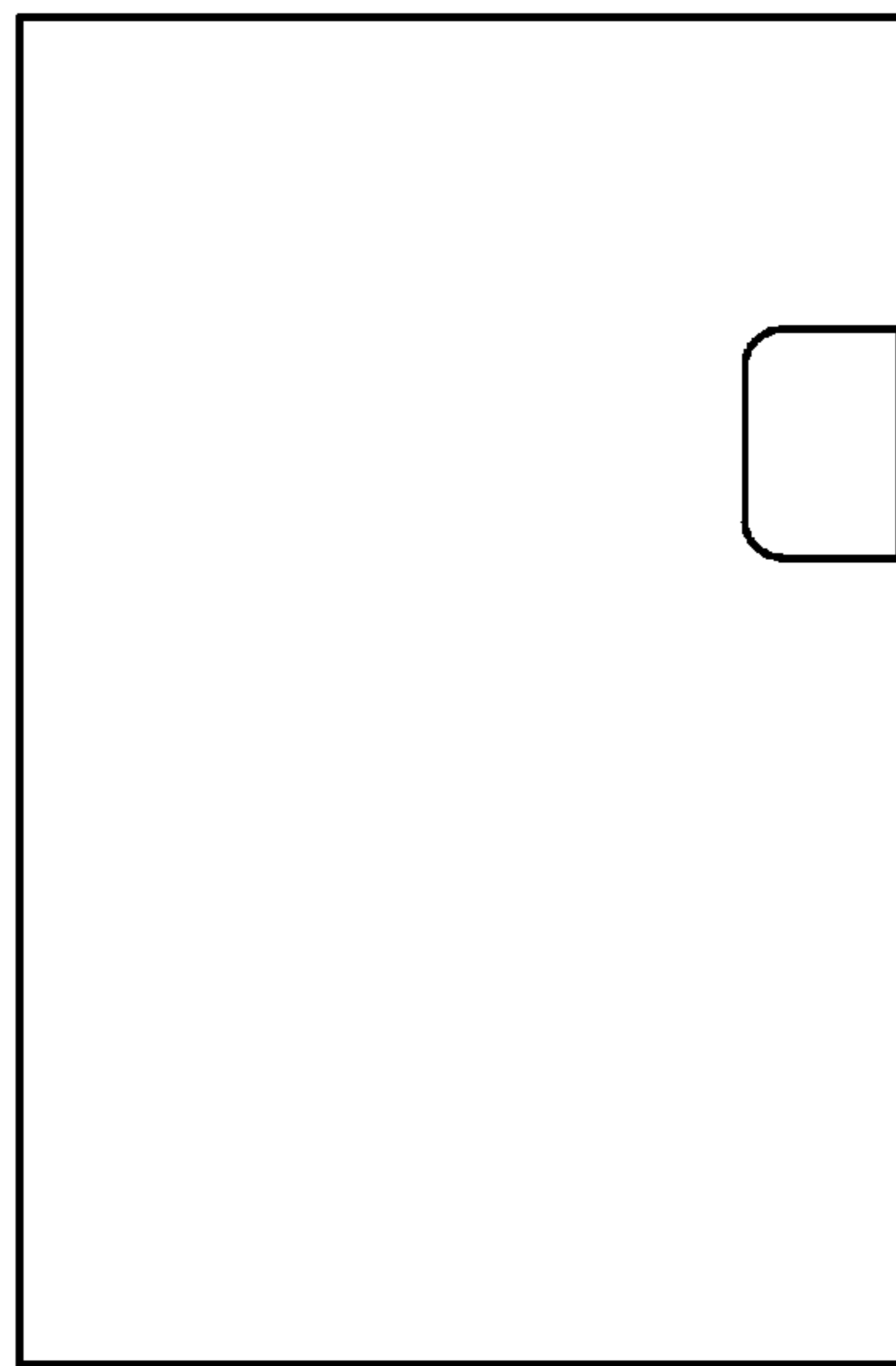

FIG. 28

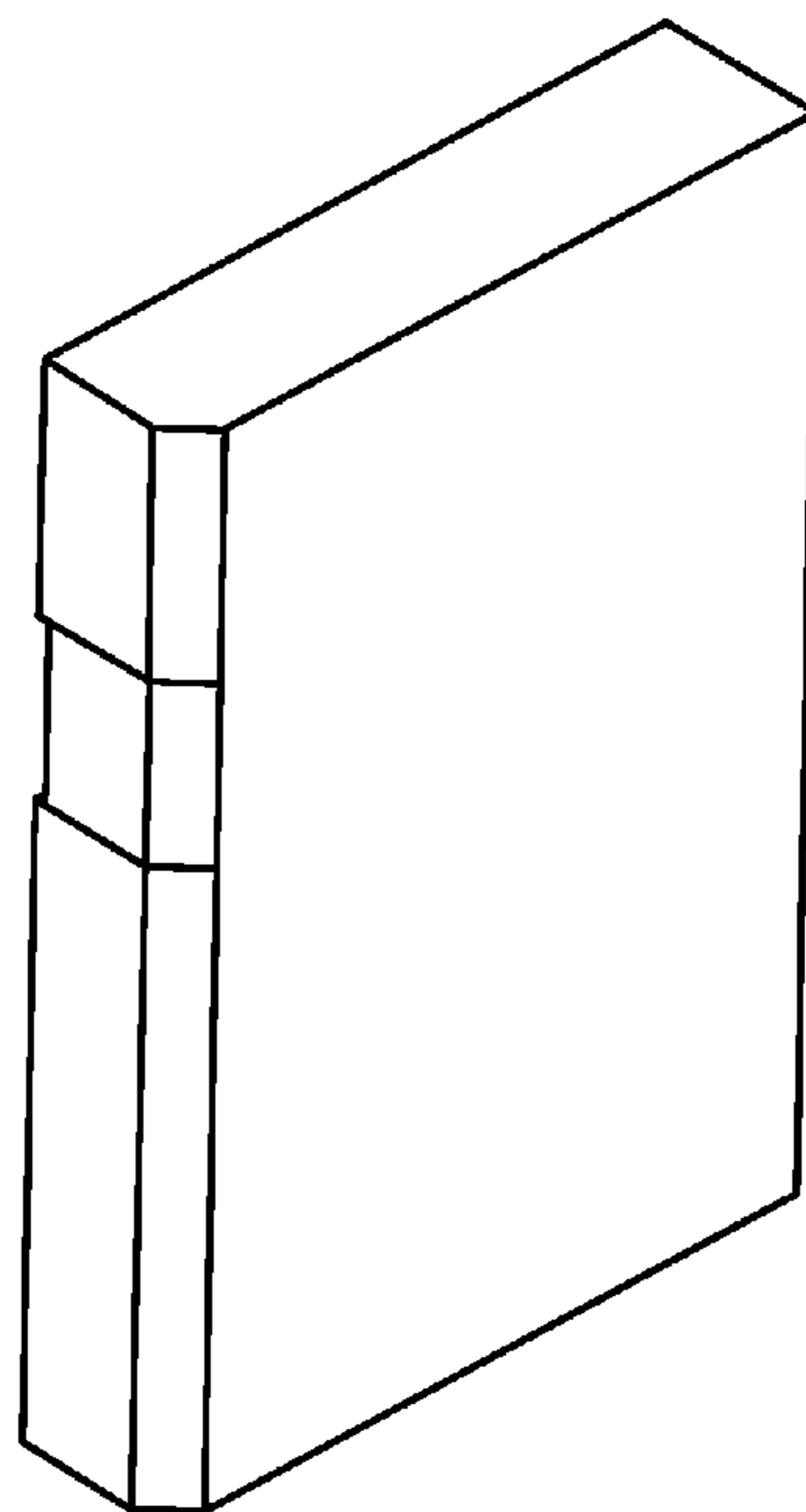

FIG. 22



FIG. 23

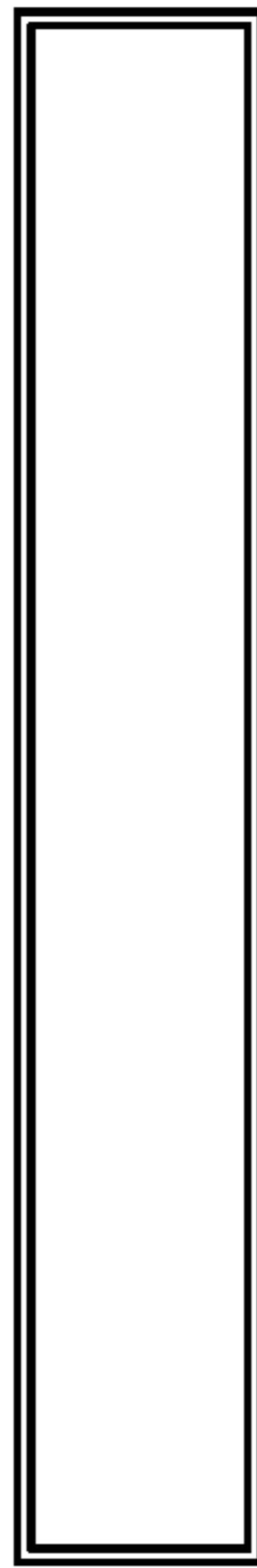

FIG. 24

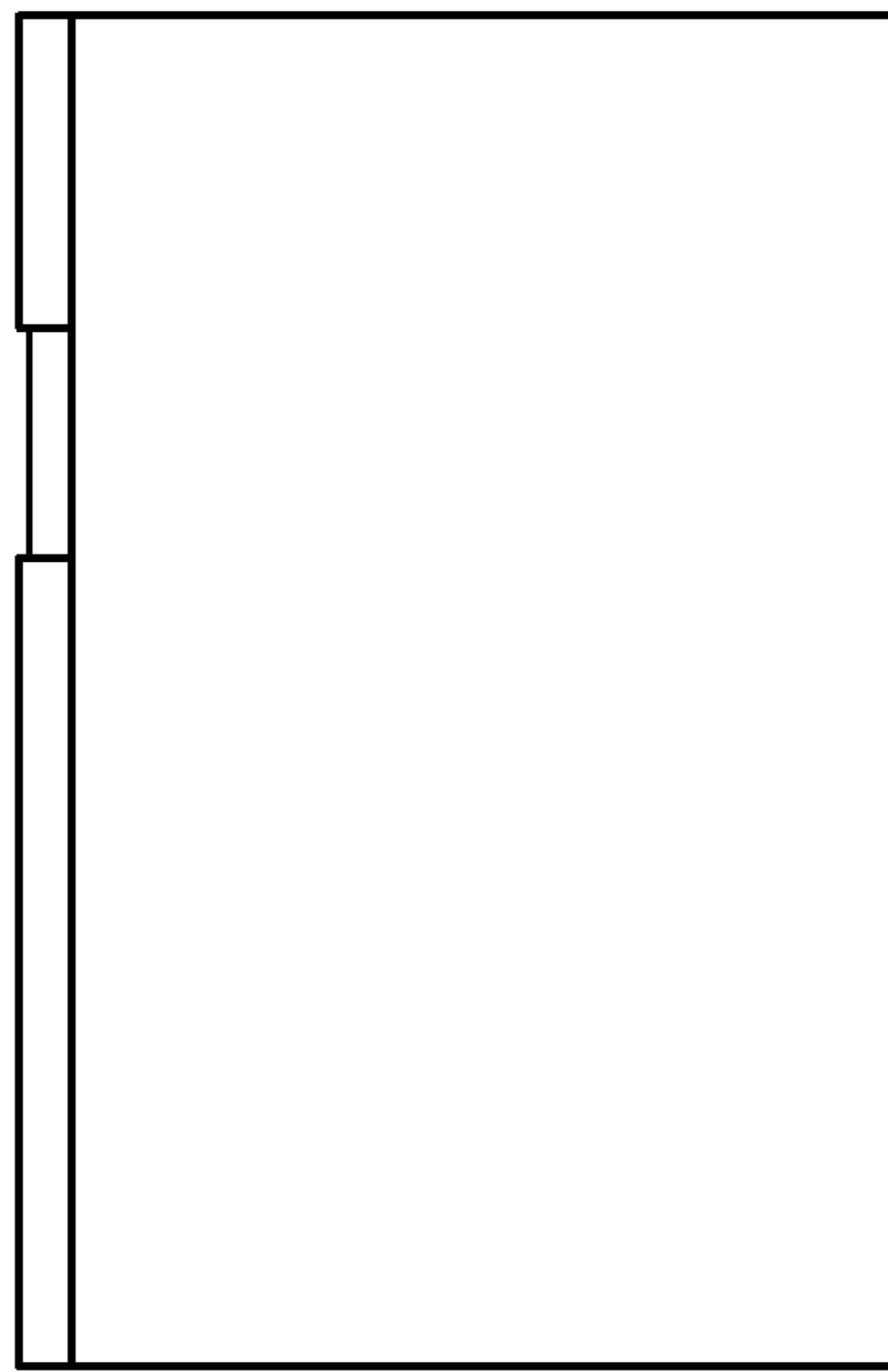

FIG. 25



FIG. 26

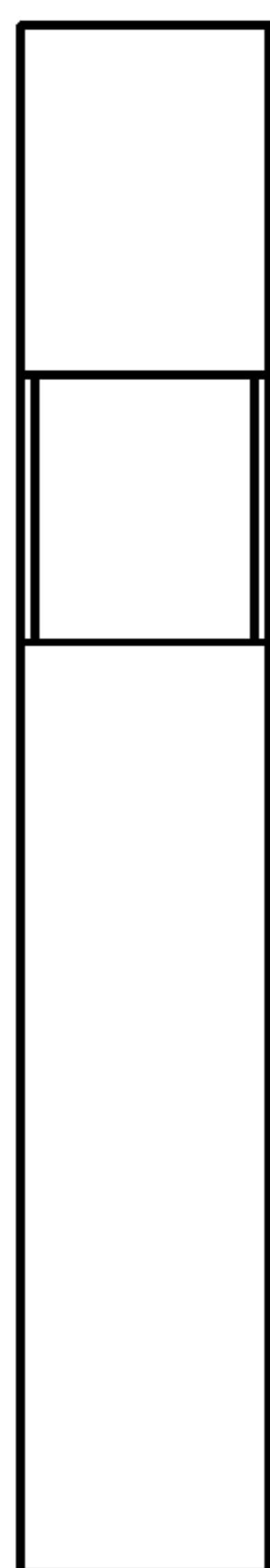

FIG. 34

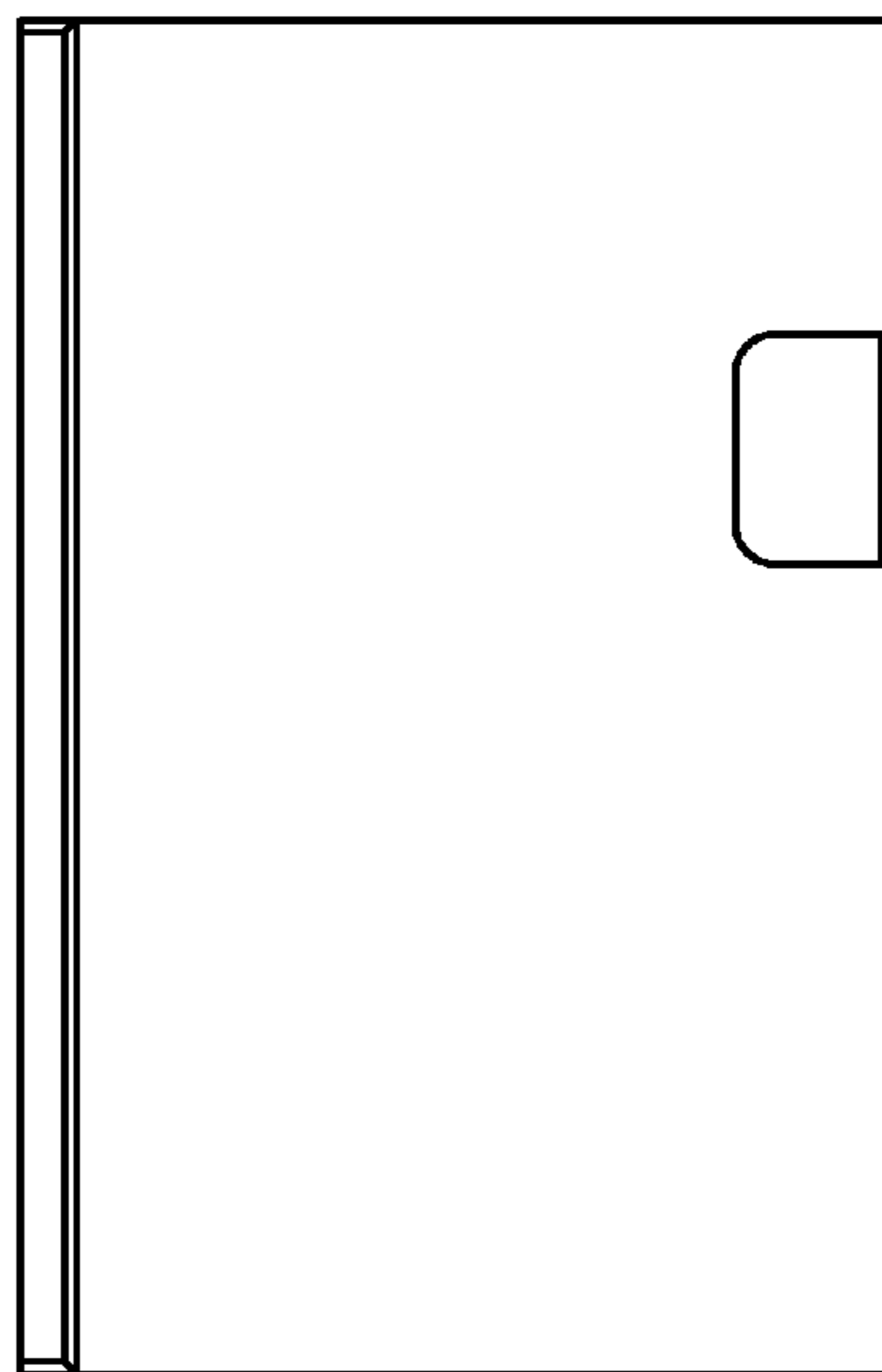

FIG. 35

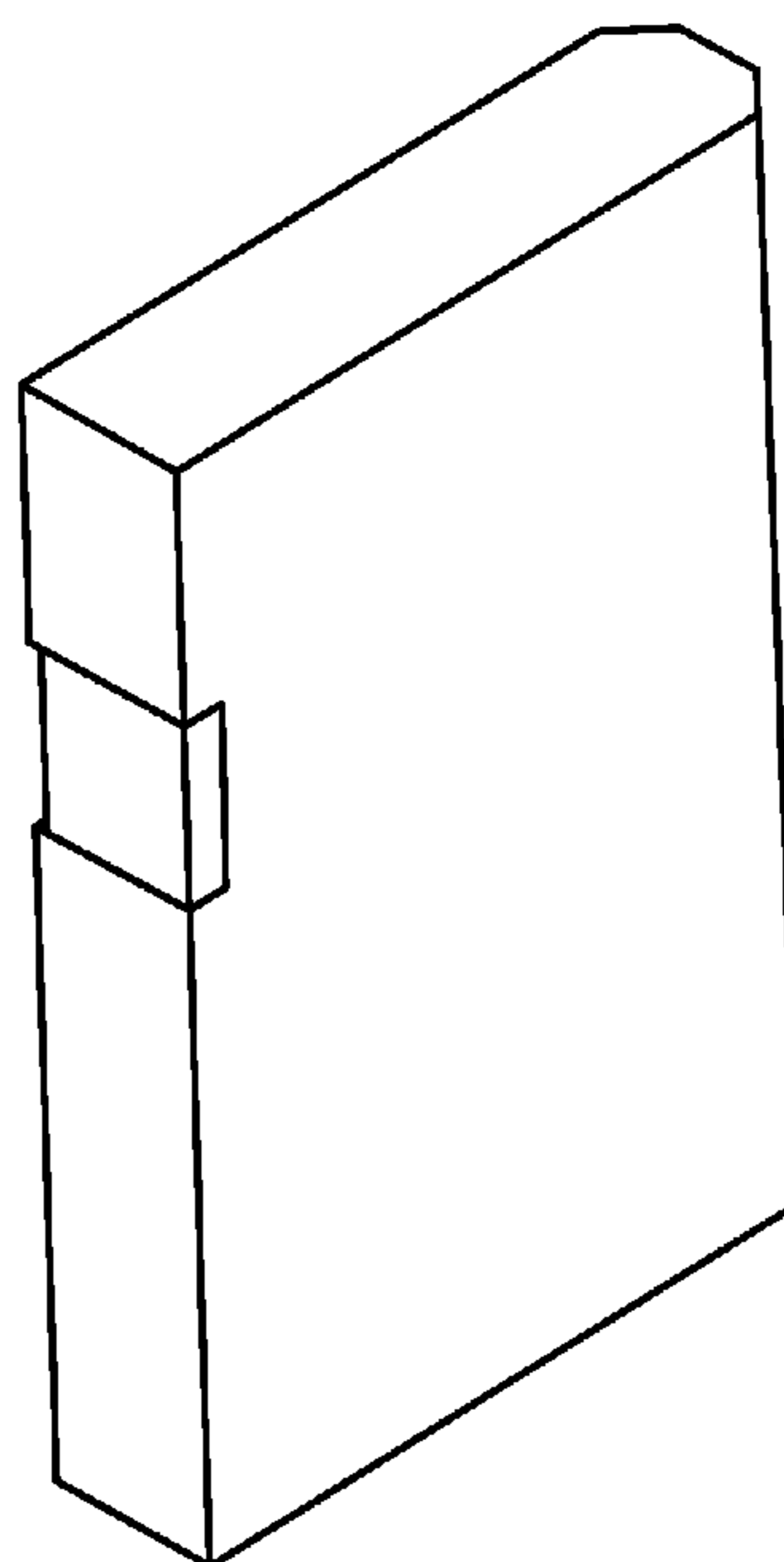

FIG. 29



FIG. 30

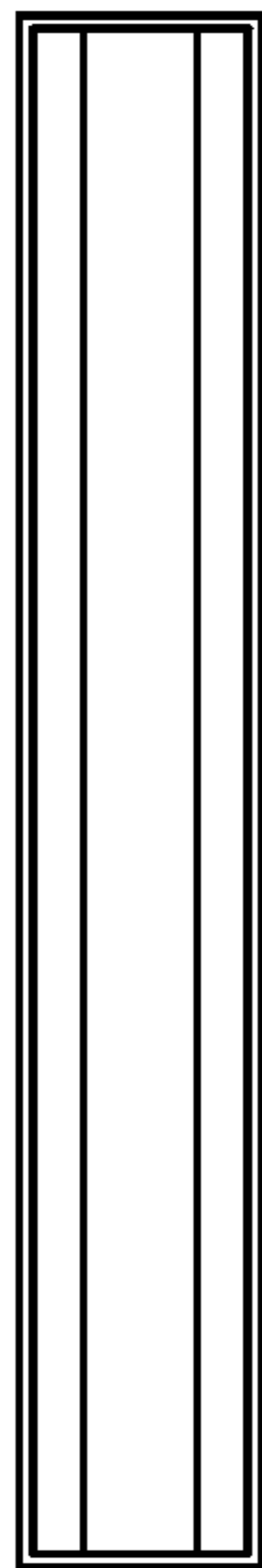

FIG. 31

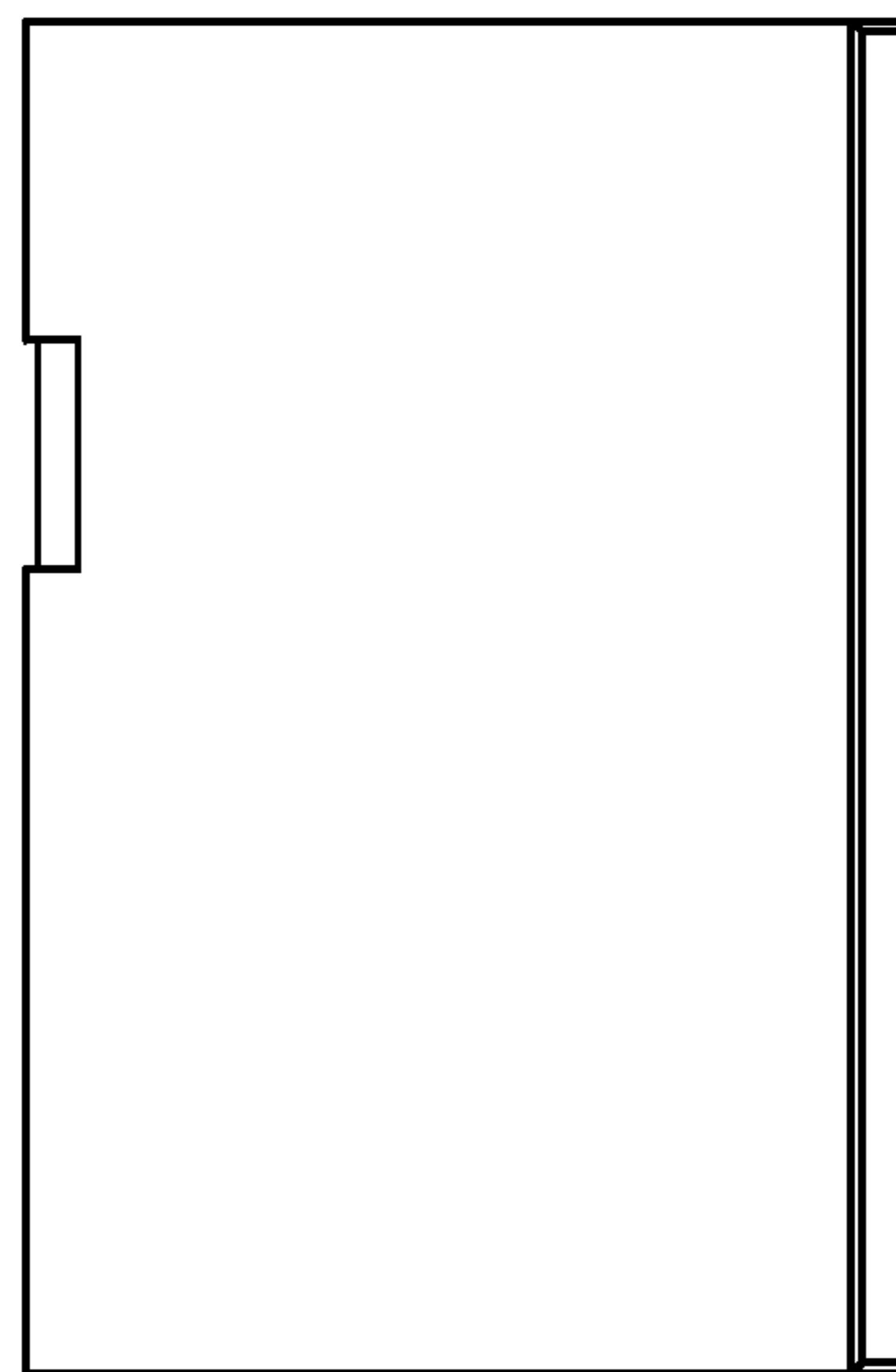

FIG. 32



FIG. 33

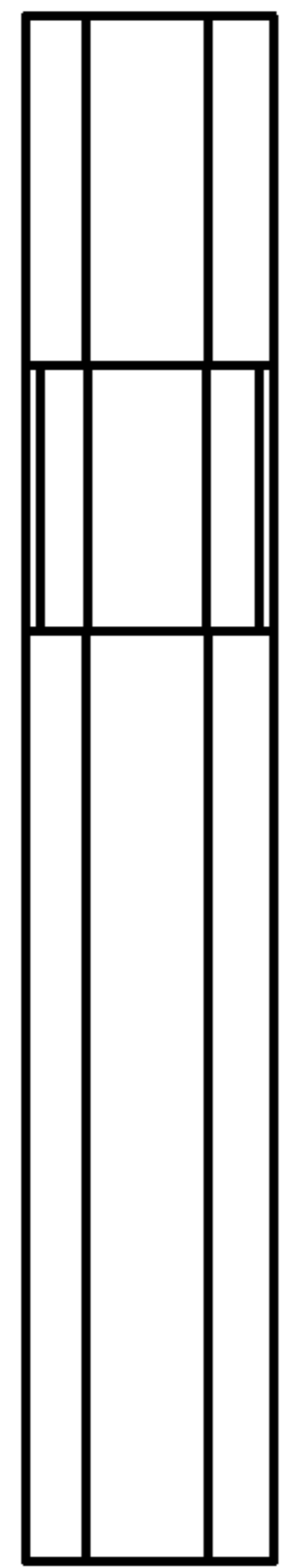

FIG. 41

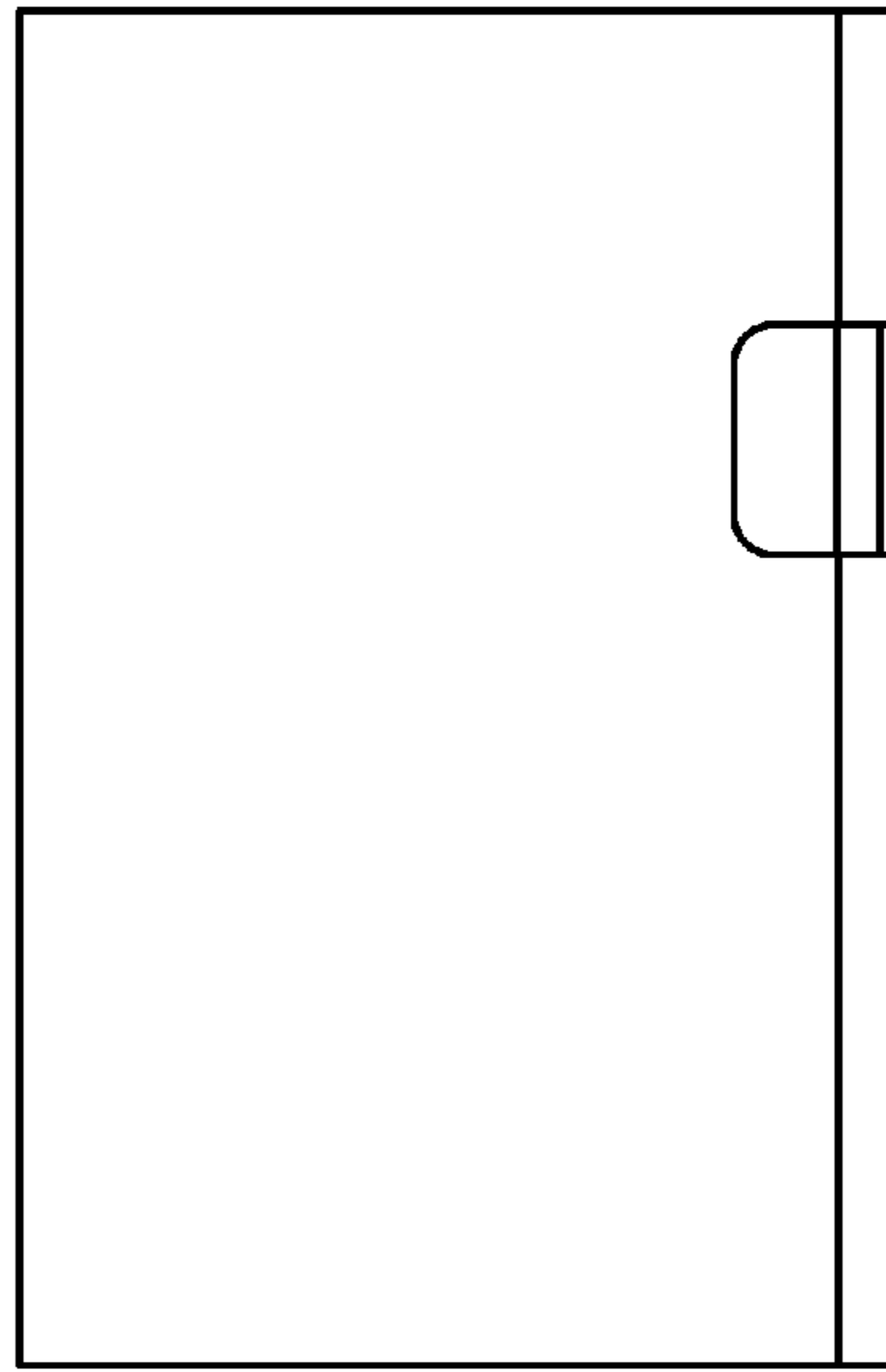

FIG. 42

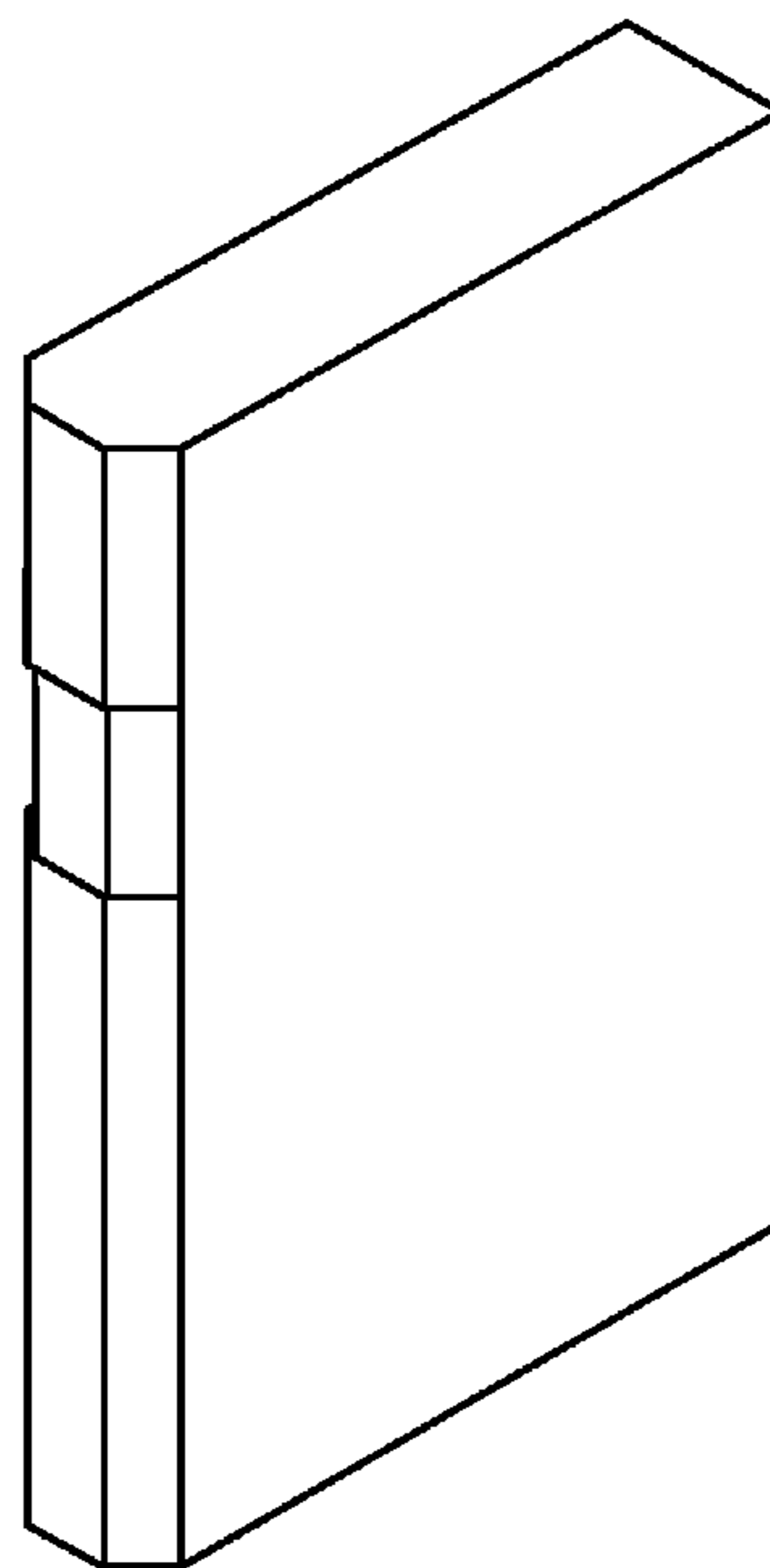

FIG. 36



FIG. 37

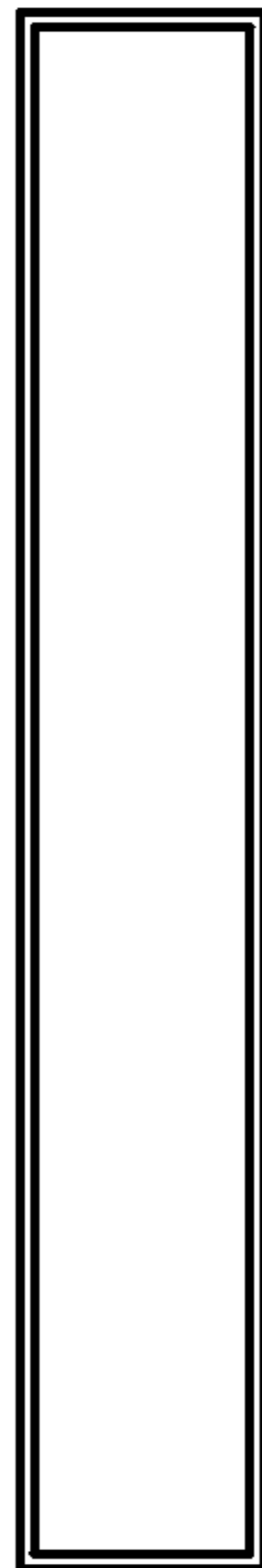

FIG. 38

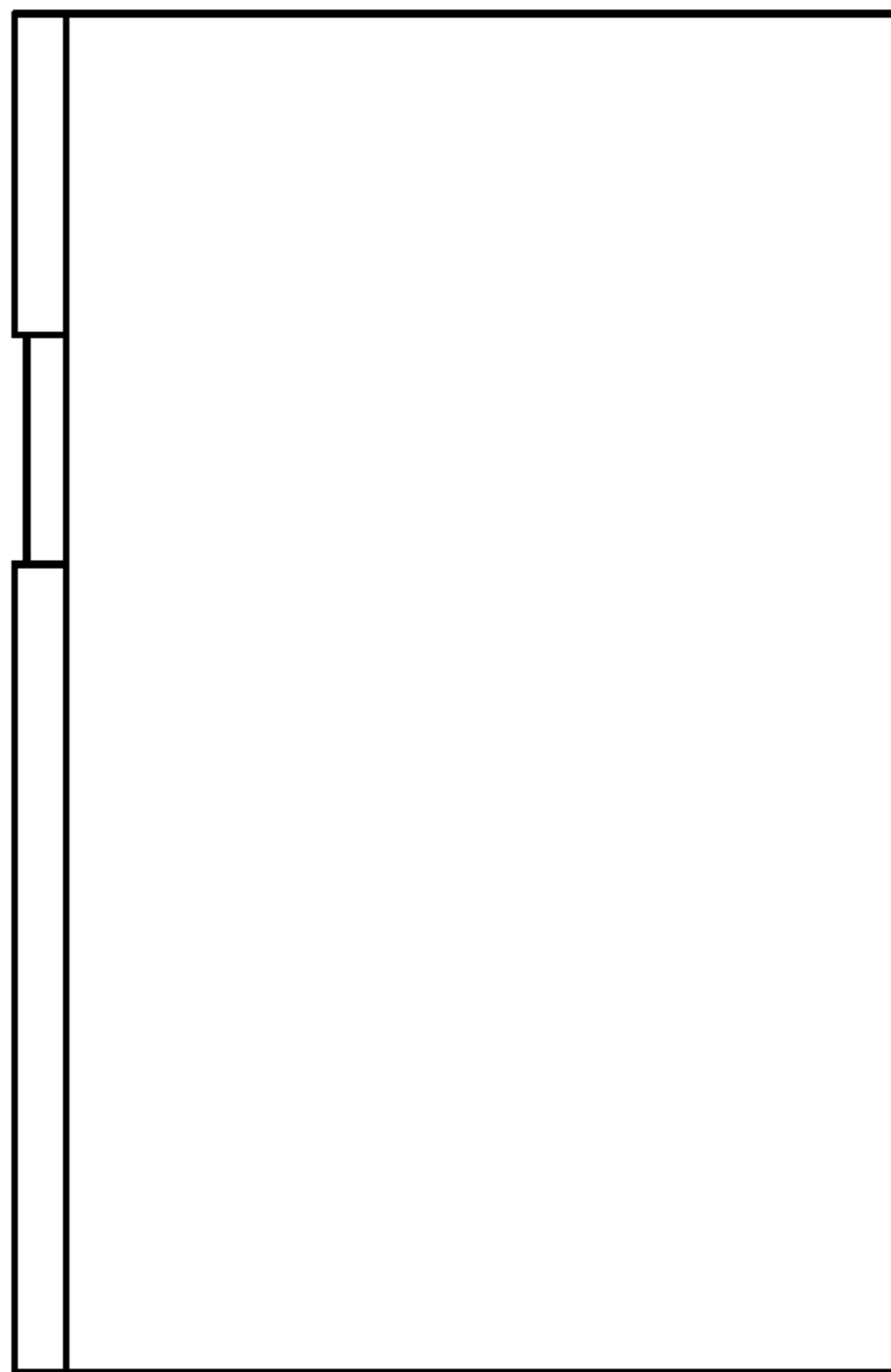

FIG. 39



FIG. 40

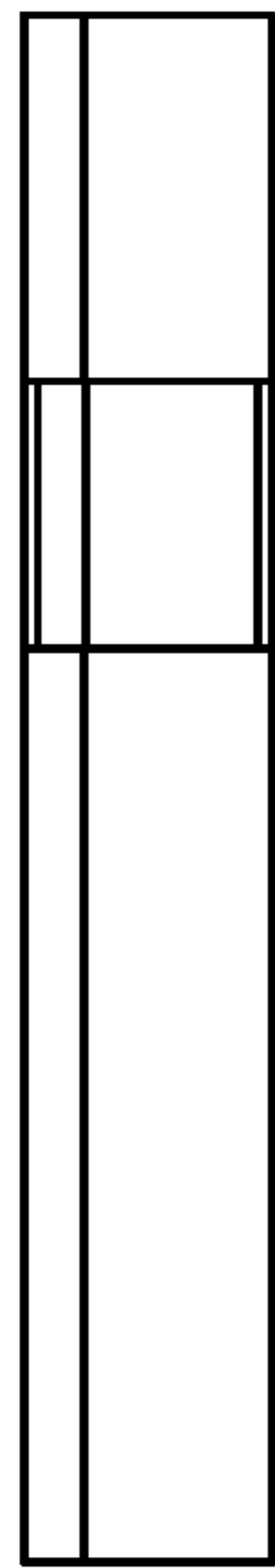

FIG. 48

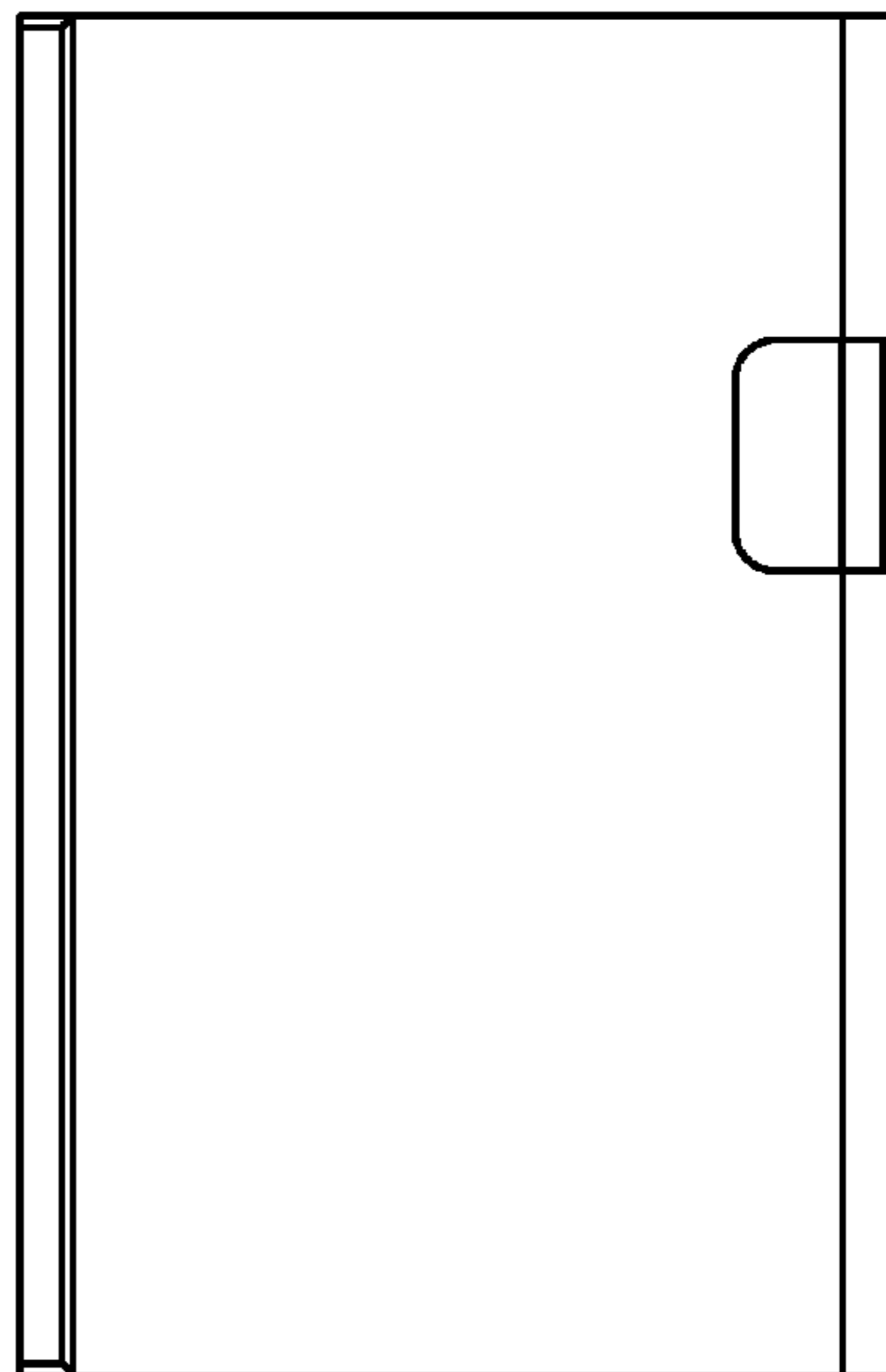

FIG. 49

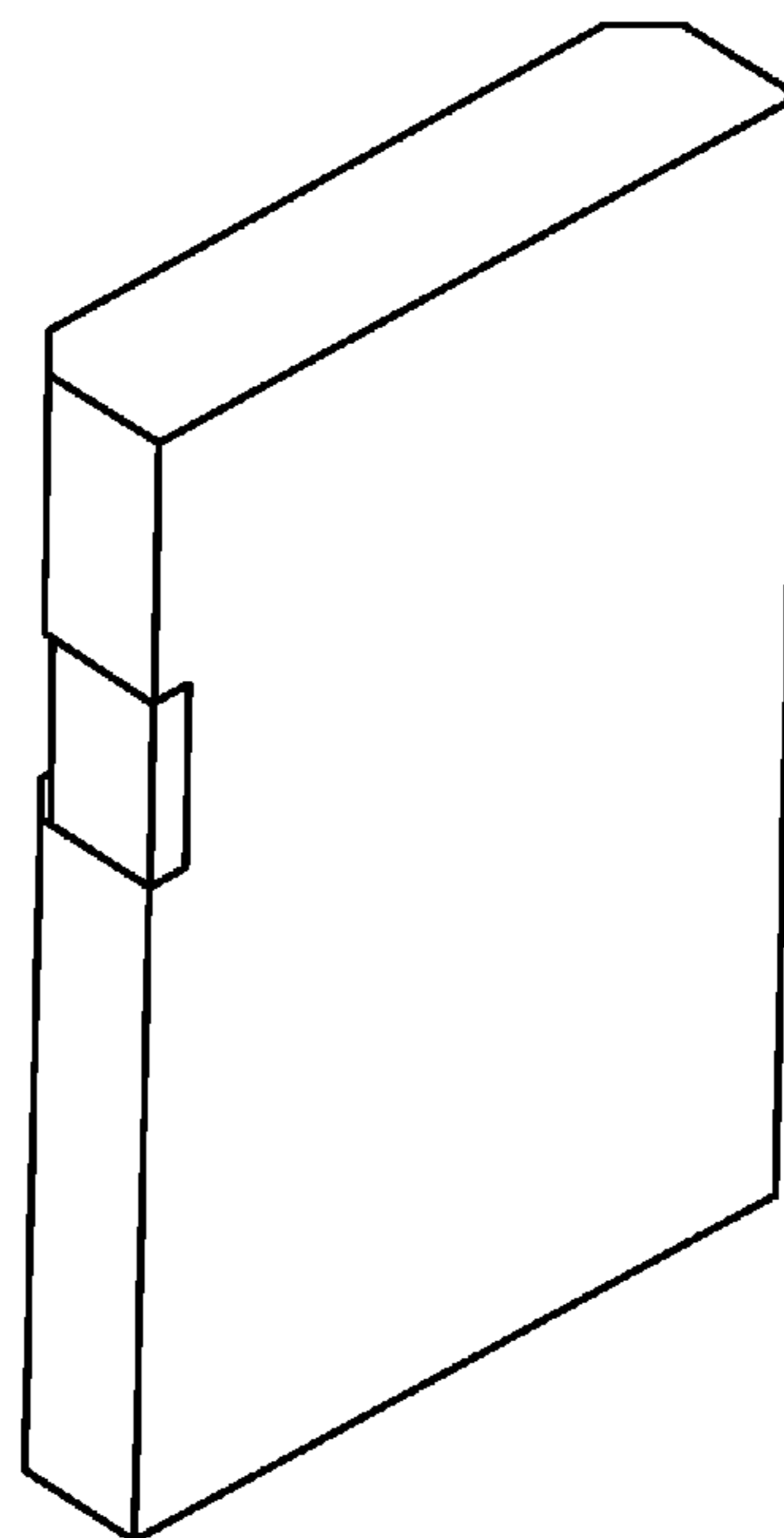

FIG. 43





FIG. 44

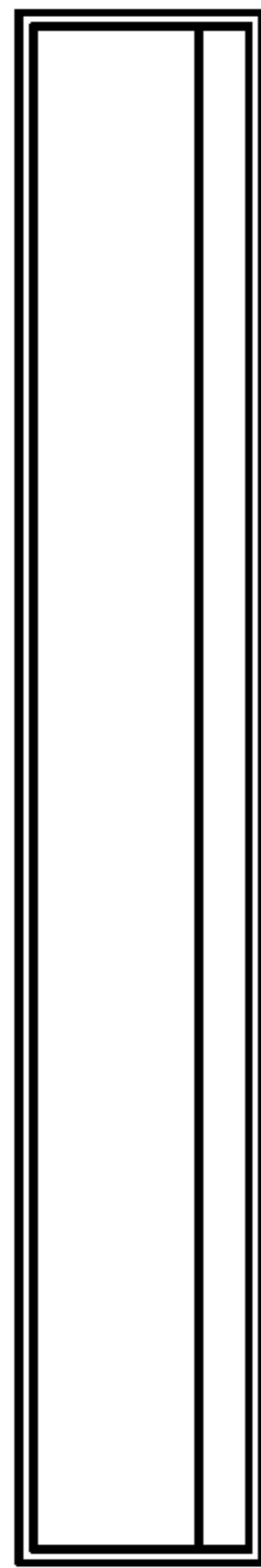

FIG. 45

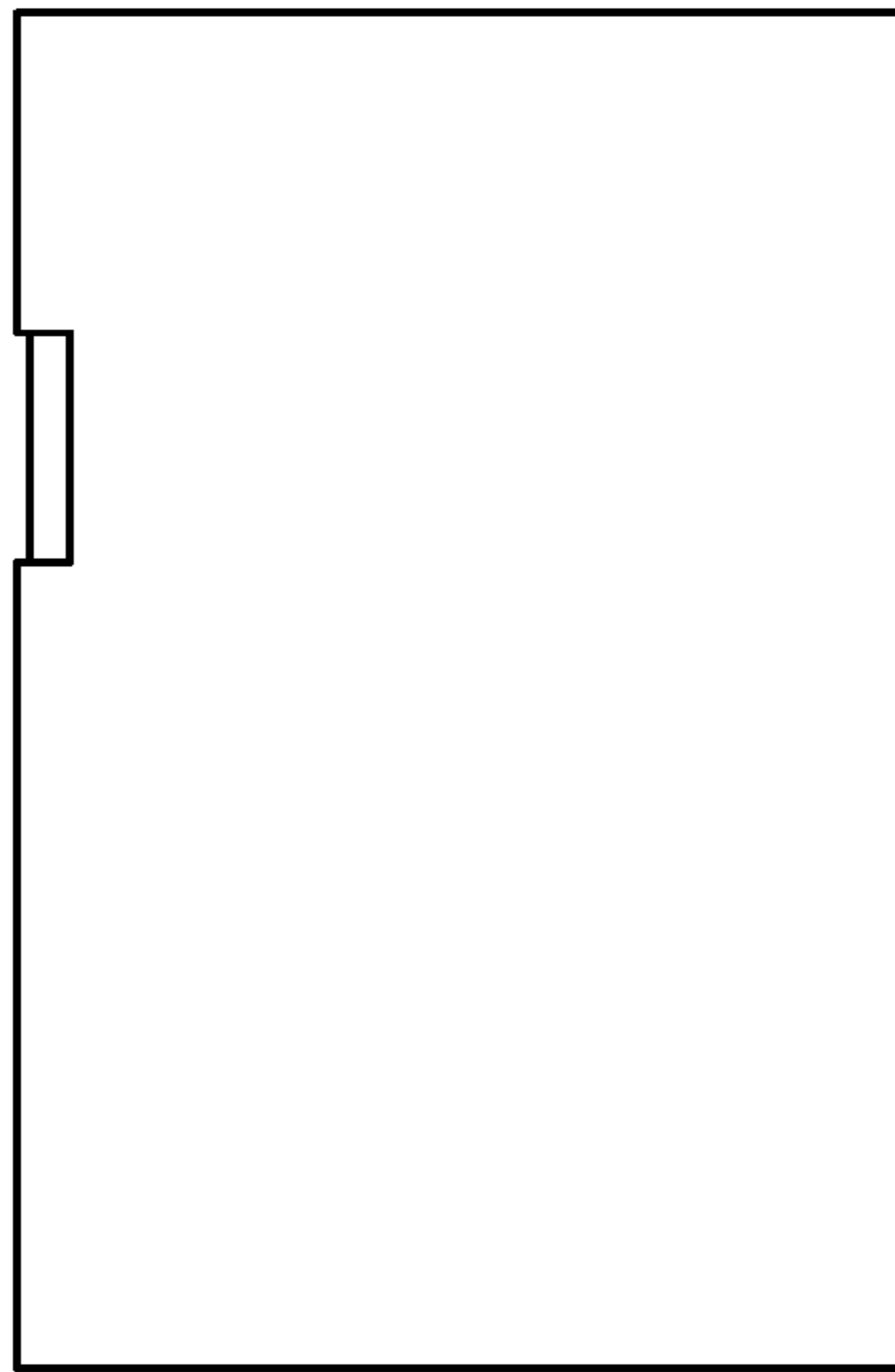

FIG. 46



FIG. 47

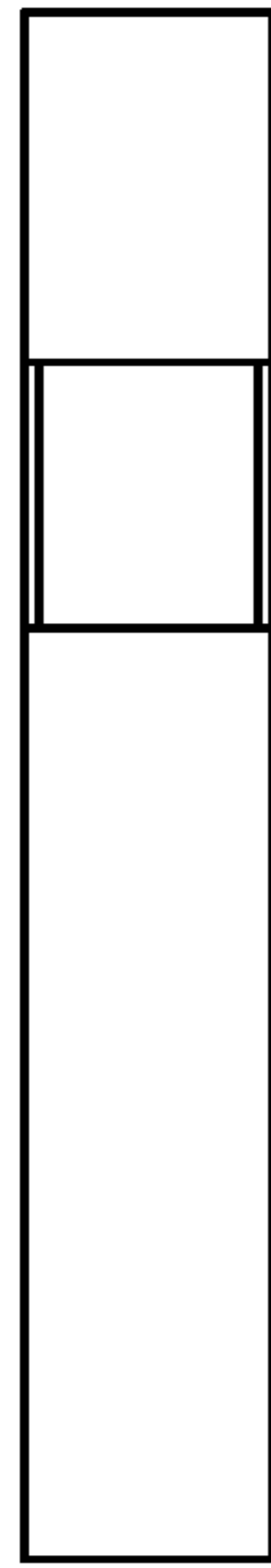

FIG. 55

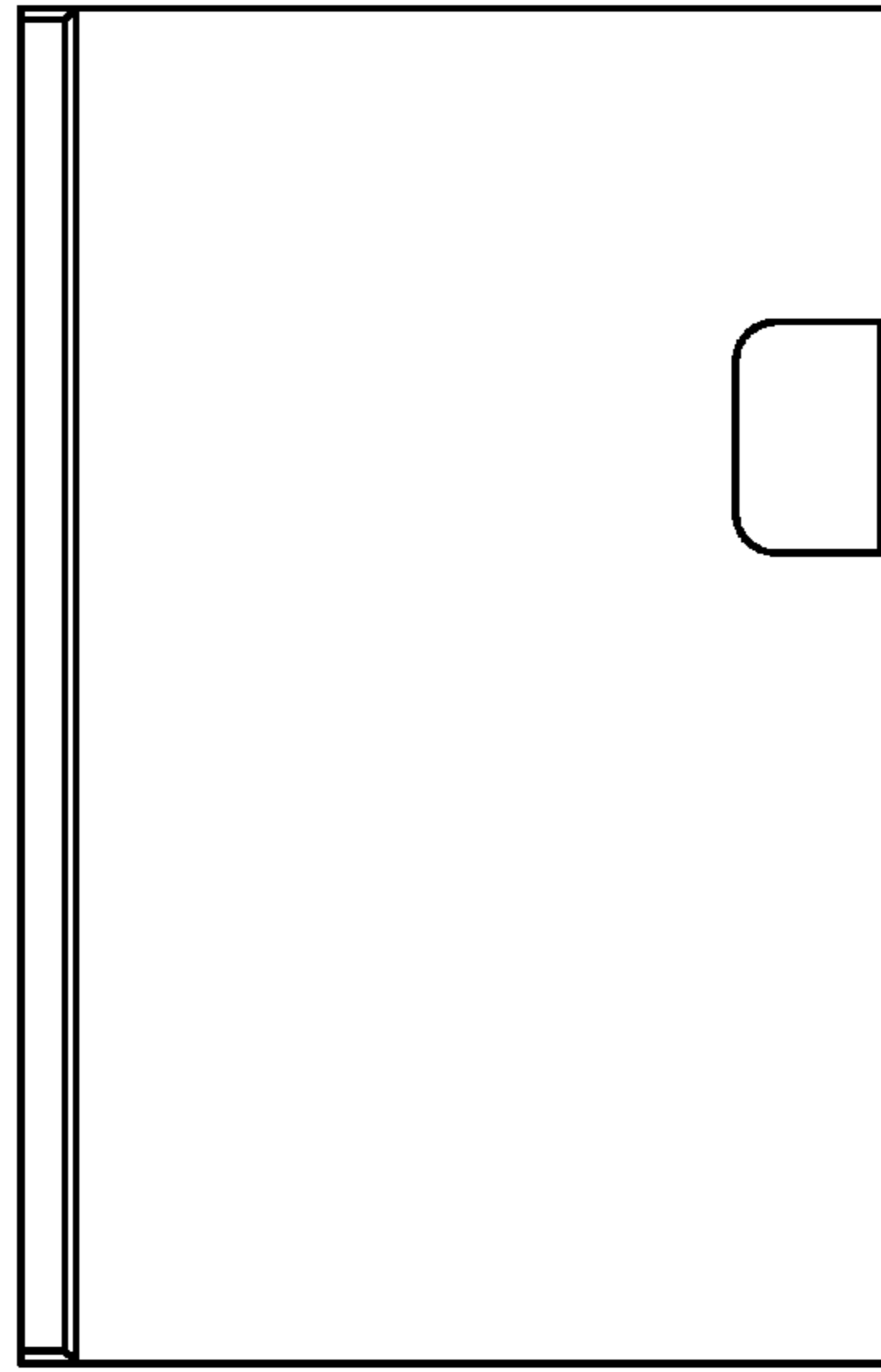

FIG. 56

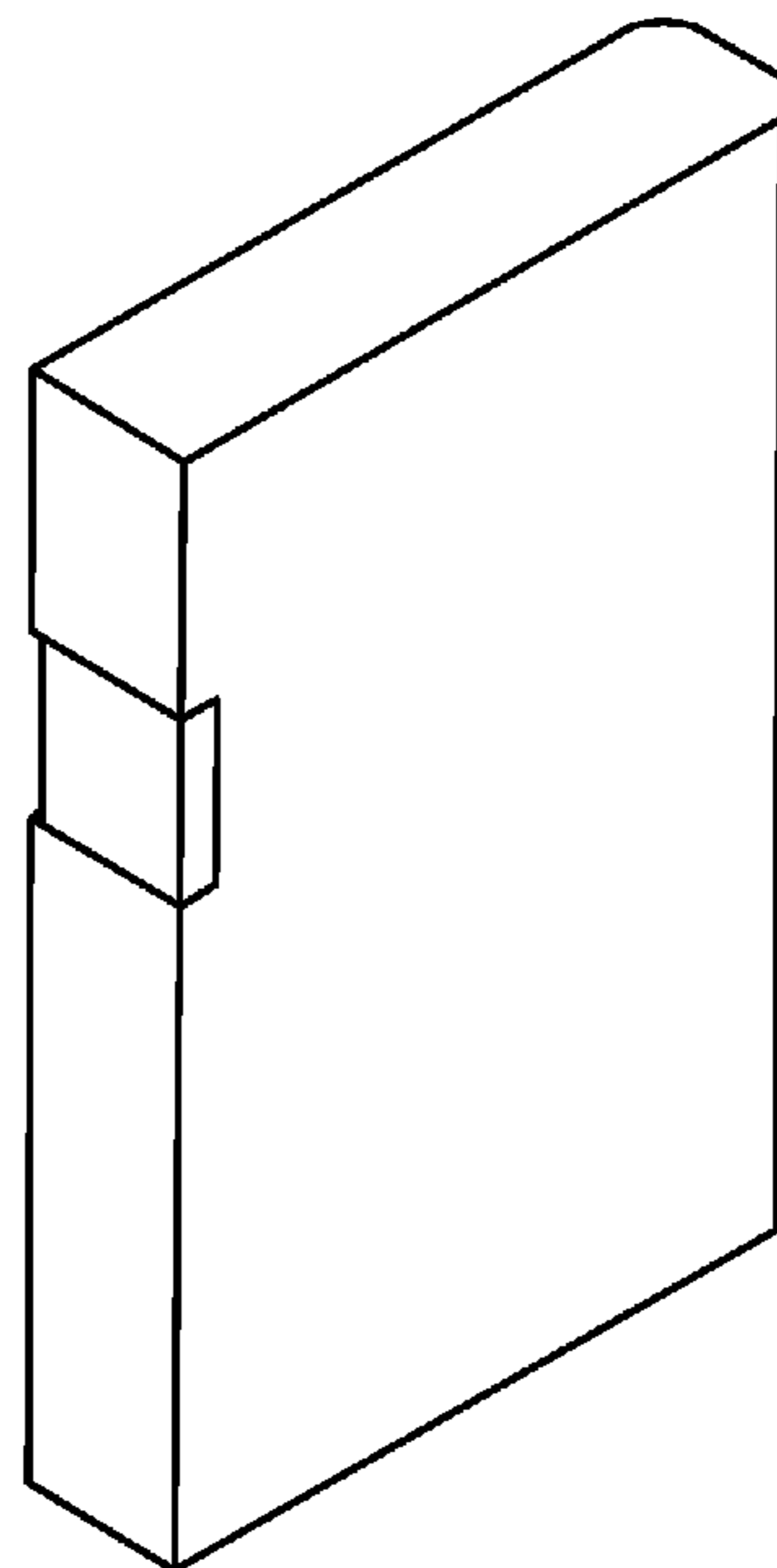

FIG. 50



FIG. 51

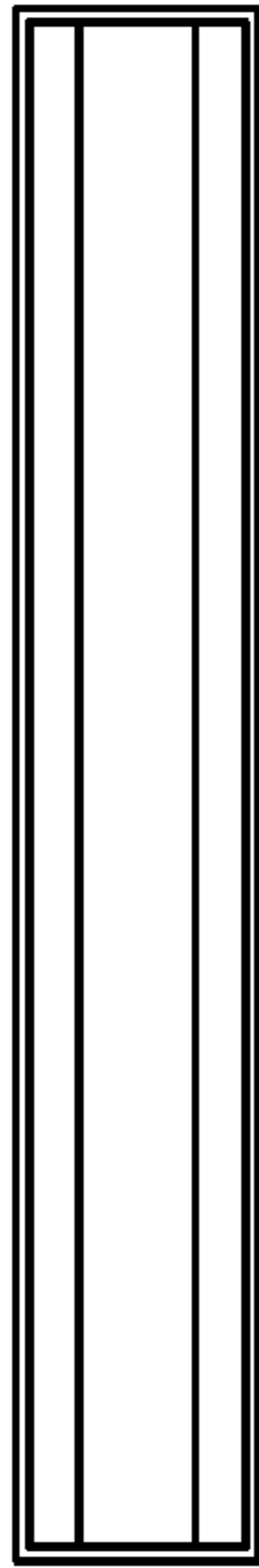

FIG. 52

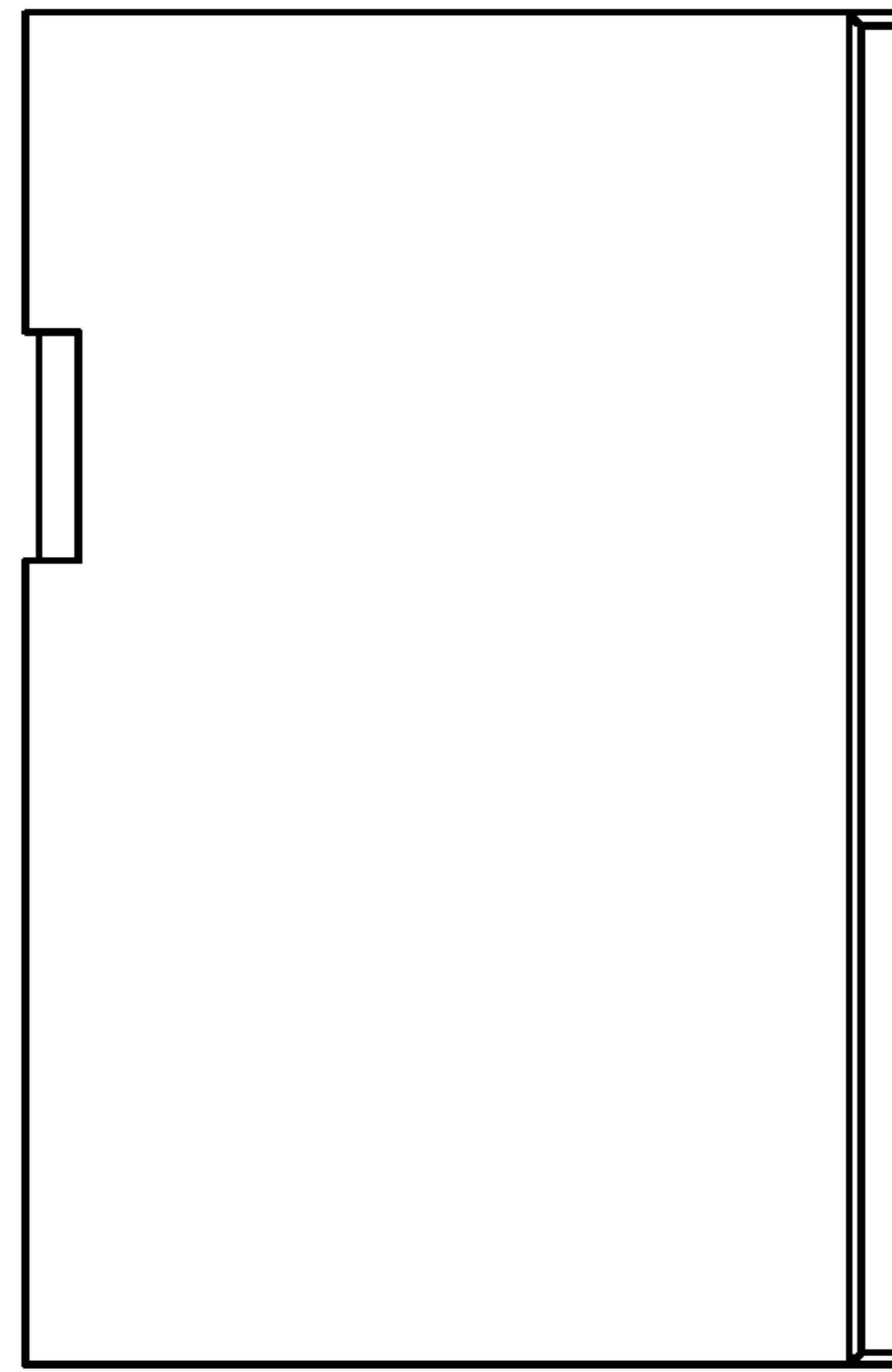

FIG. 53



FIG. 54

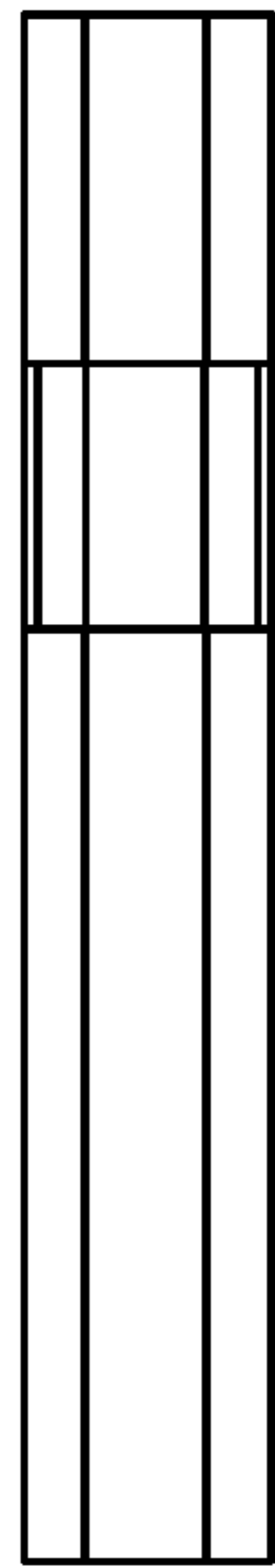

FIG. 62

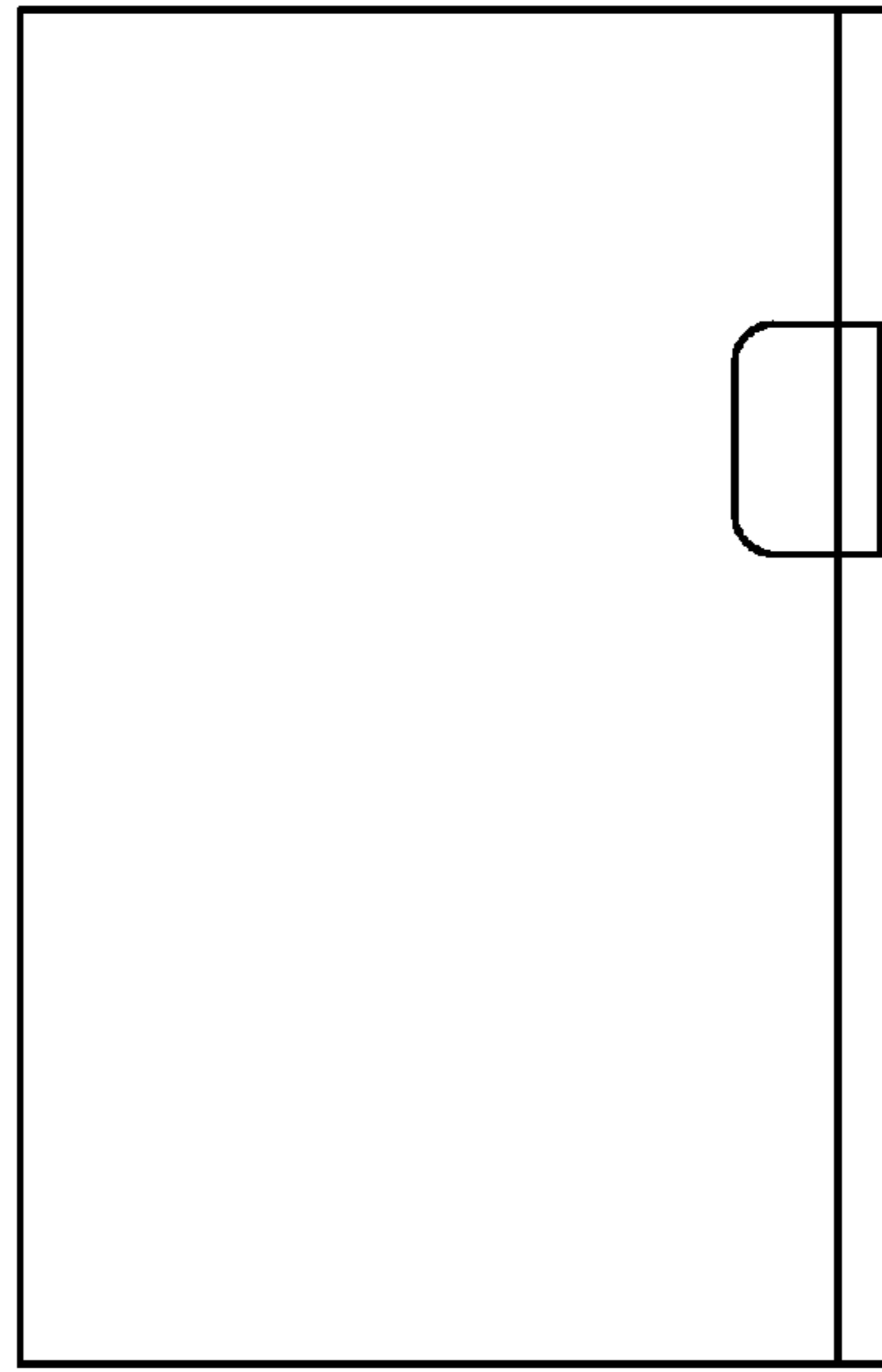

FIG. 63

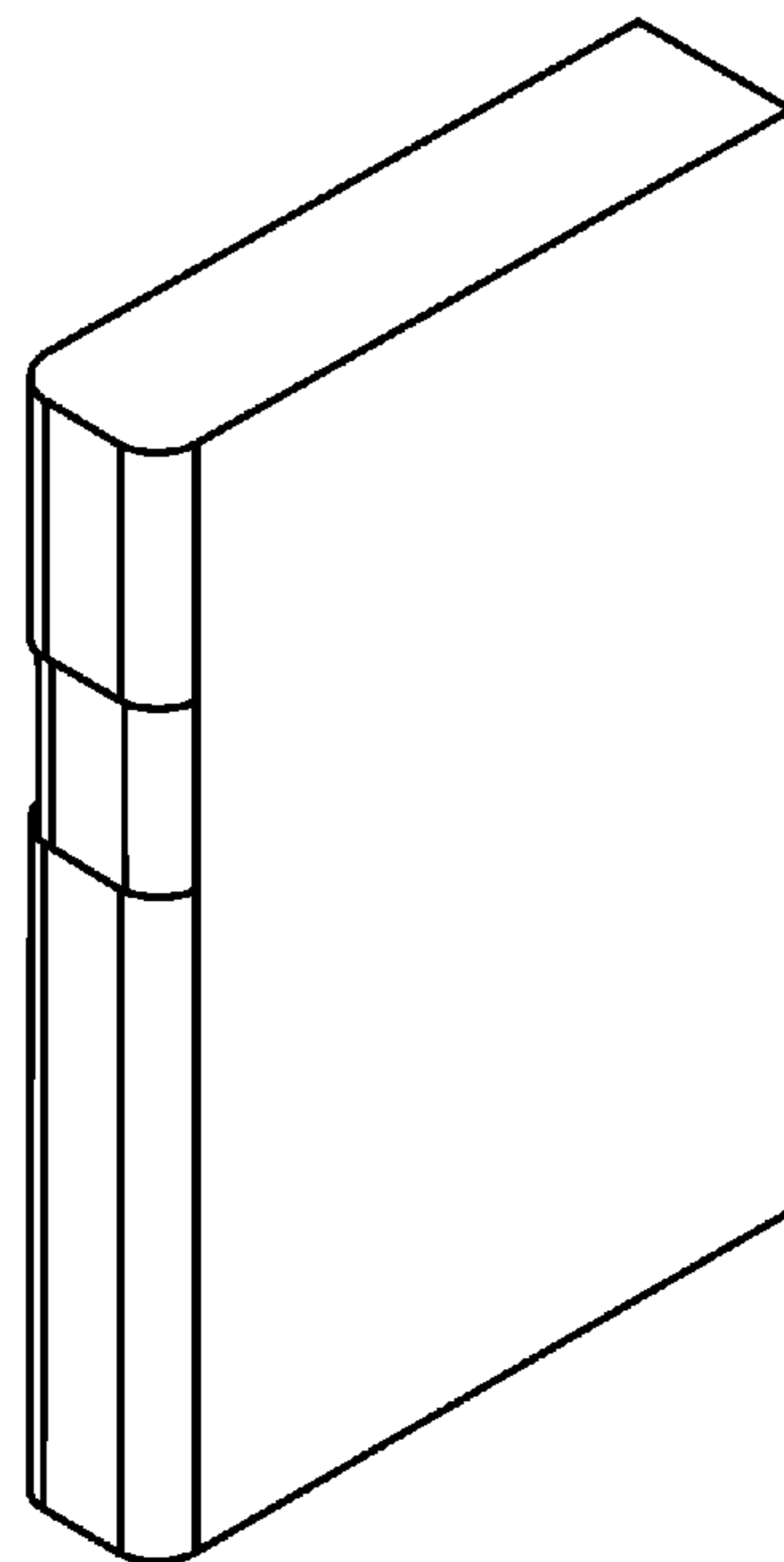

FIG. 57



FIG. 58

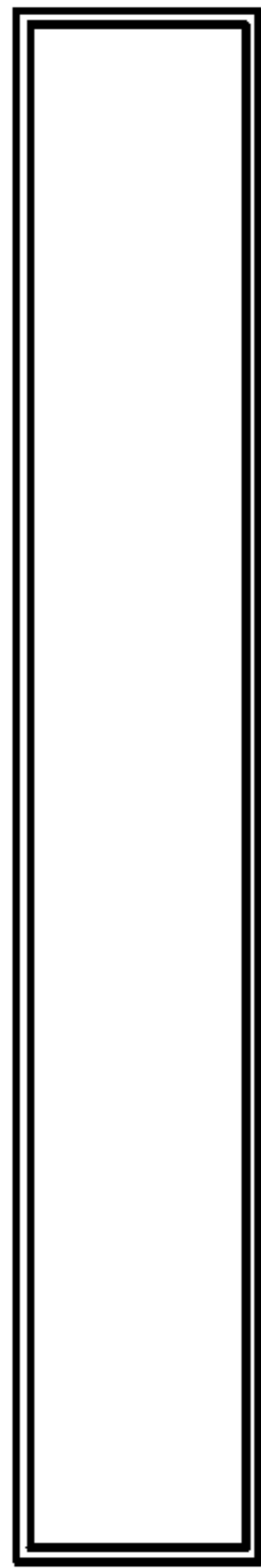

FIG. 59

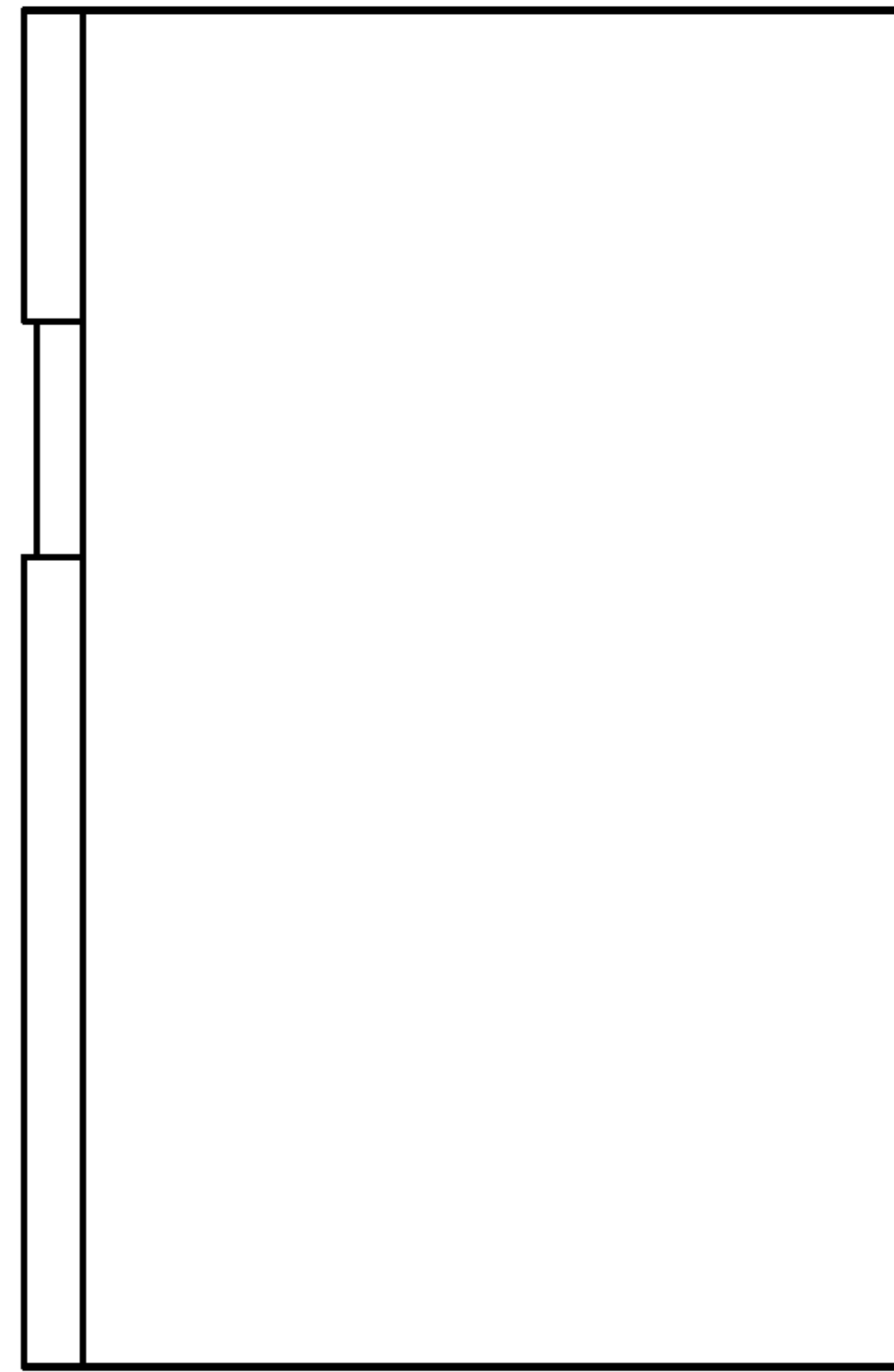

FIG. 60



FIG. 61

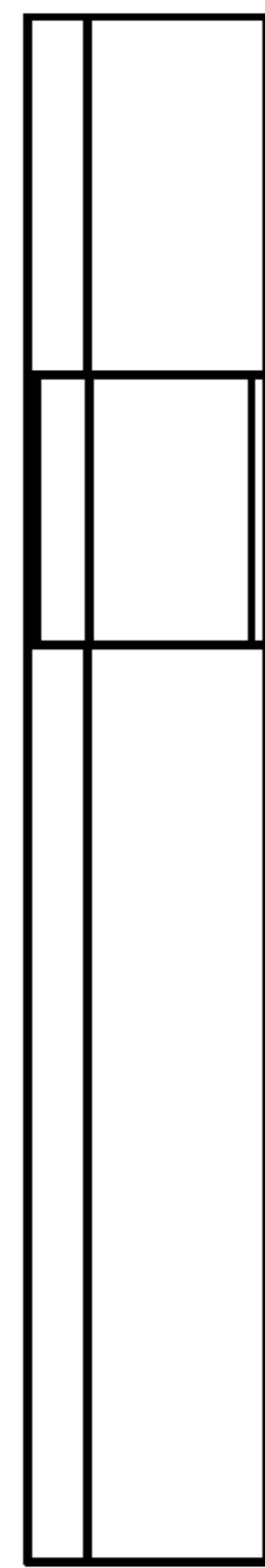

FIG. 69

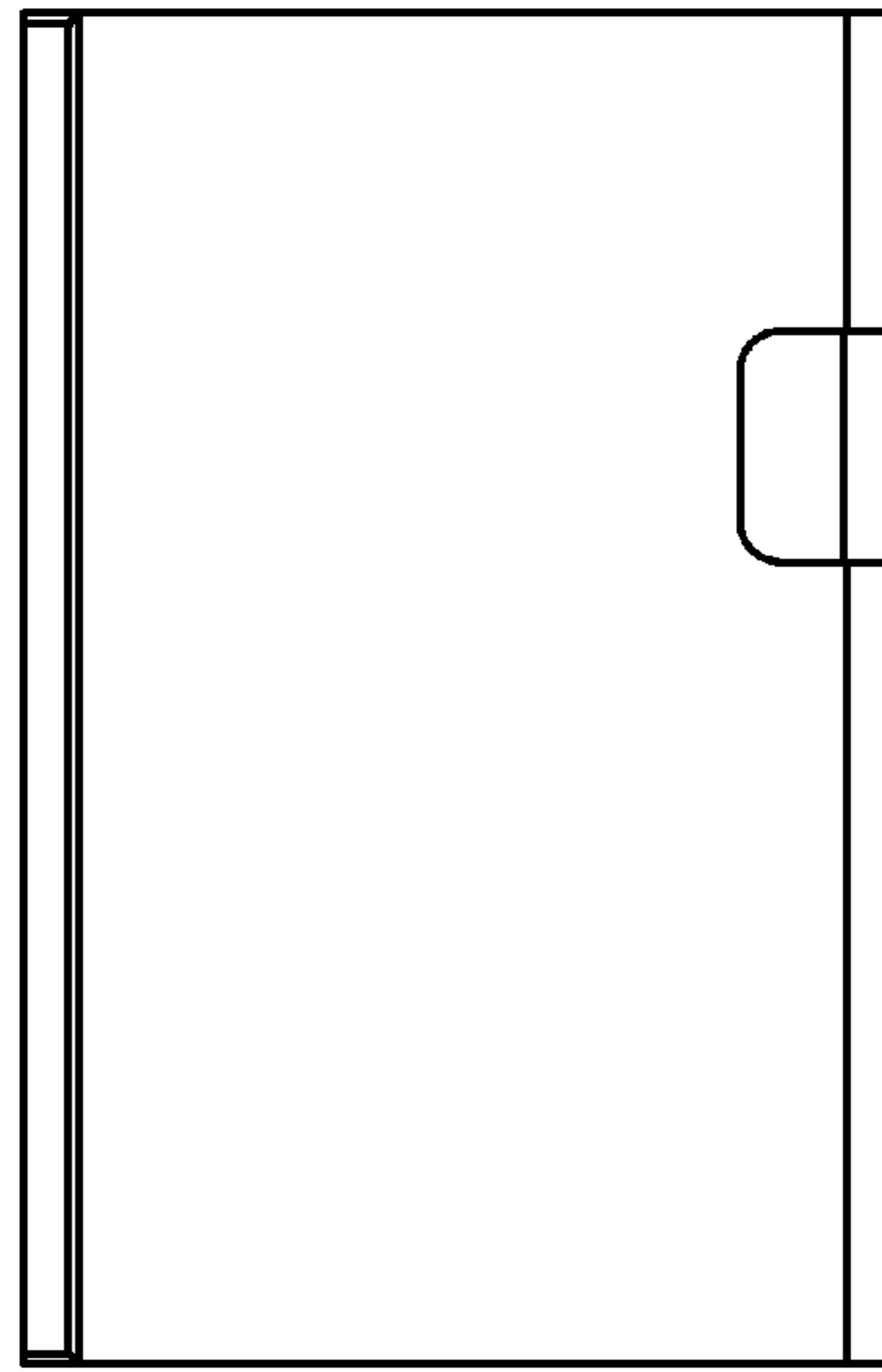

FIG. 70

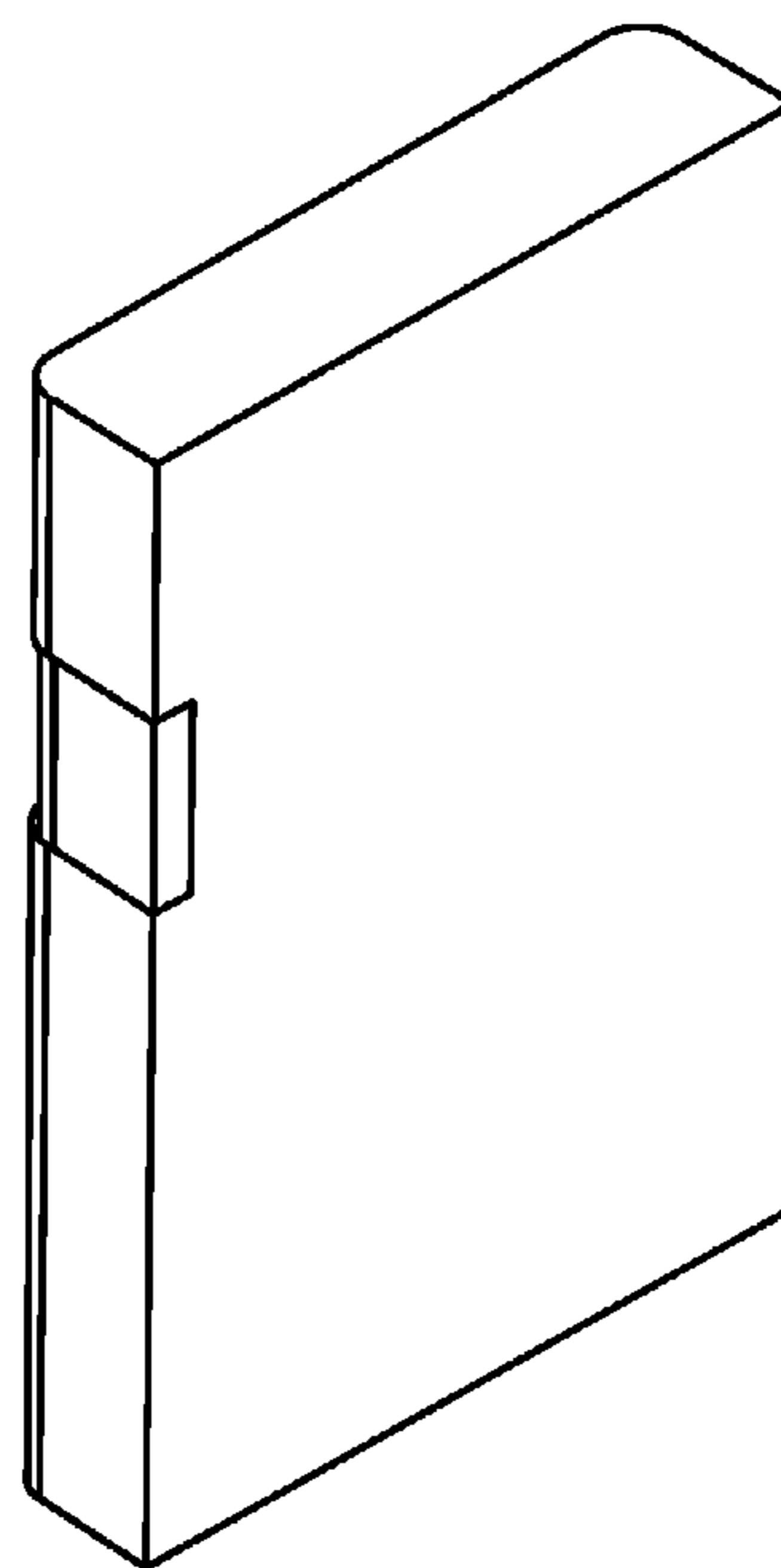

FIG. 64



FIG. 65

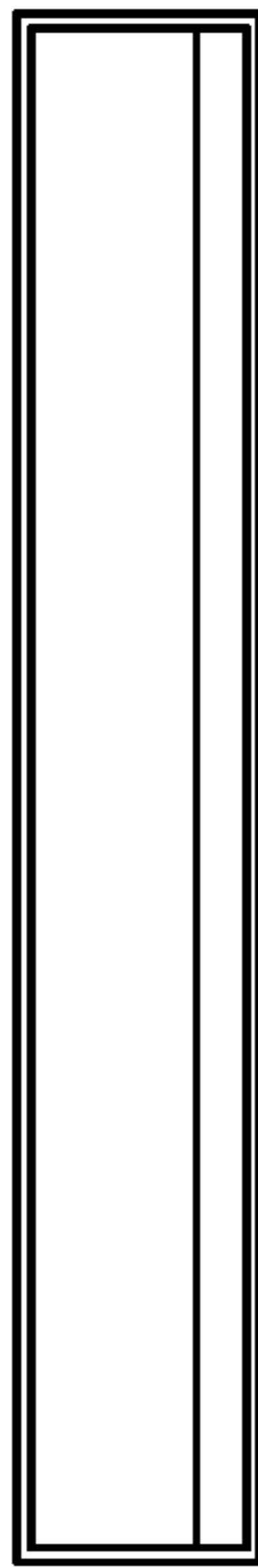

FIG. 66

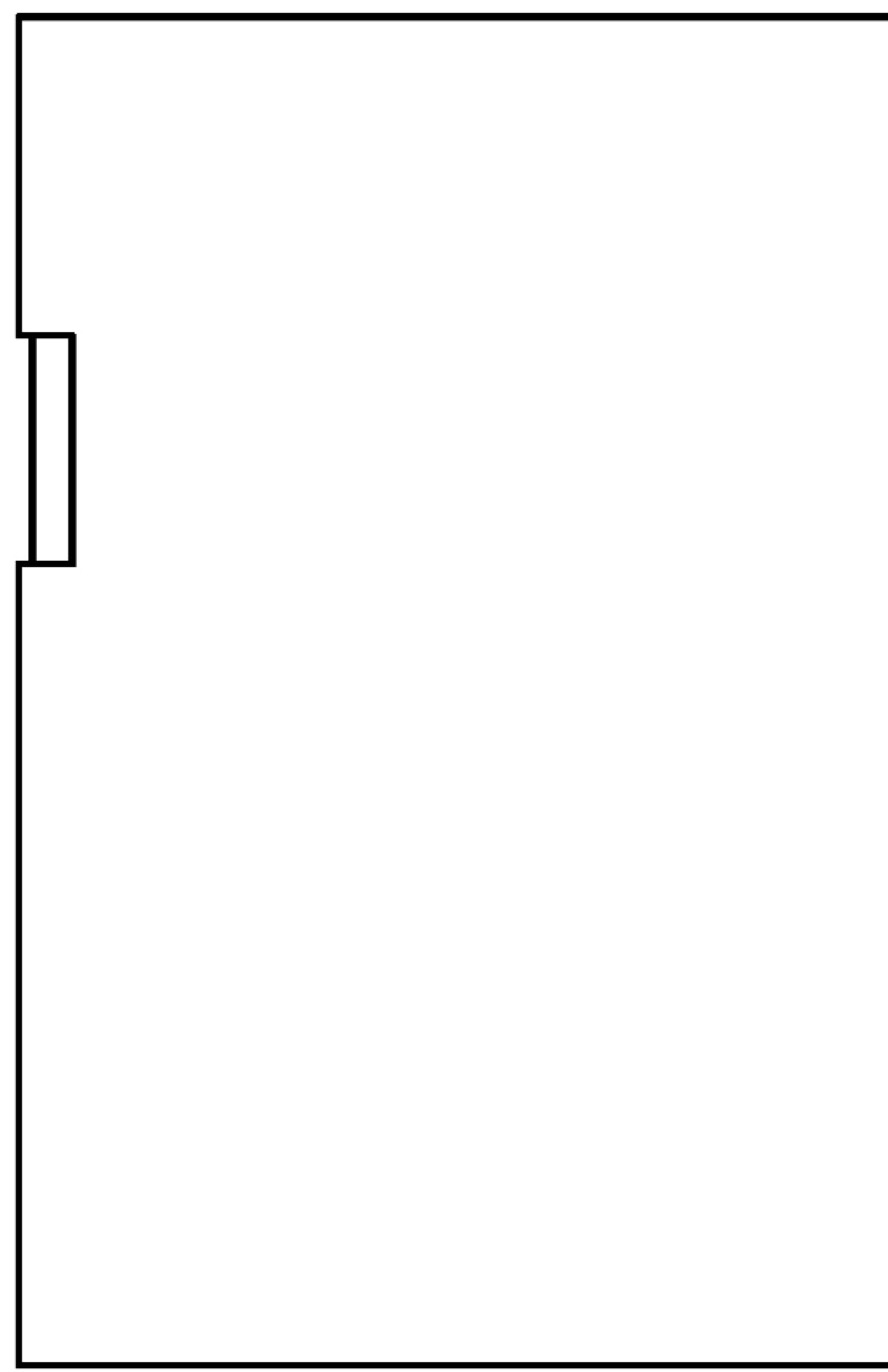

FIG. 67



FIG. 68

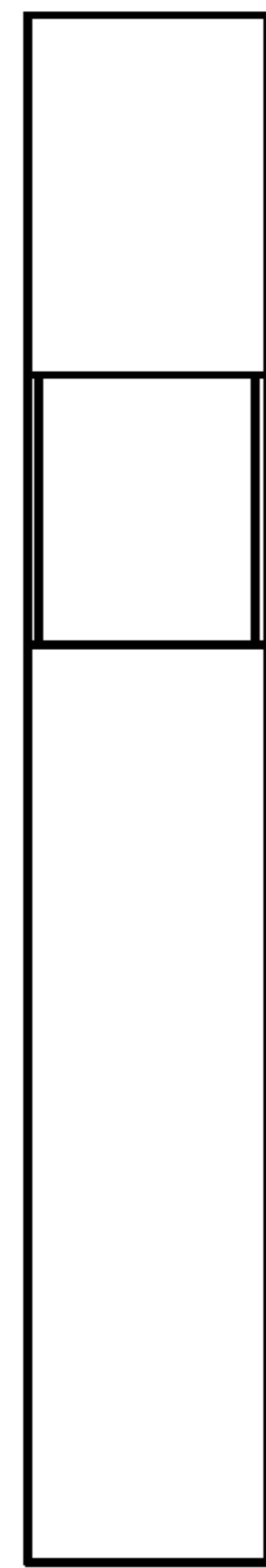

FIG. 76

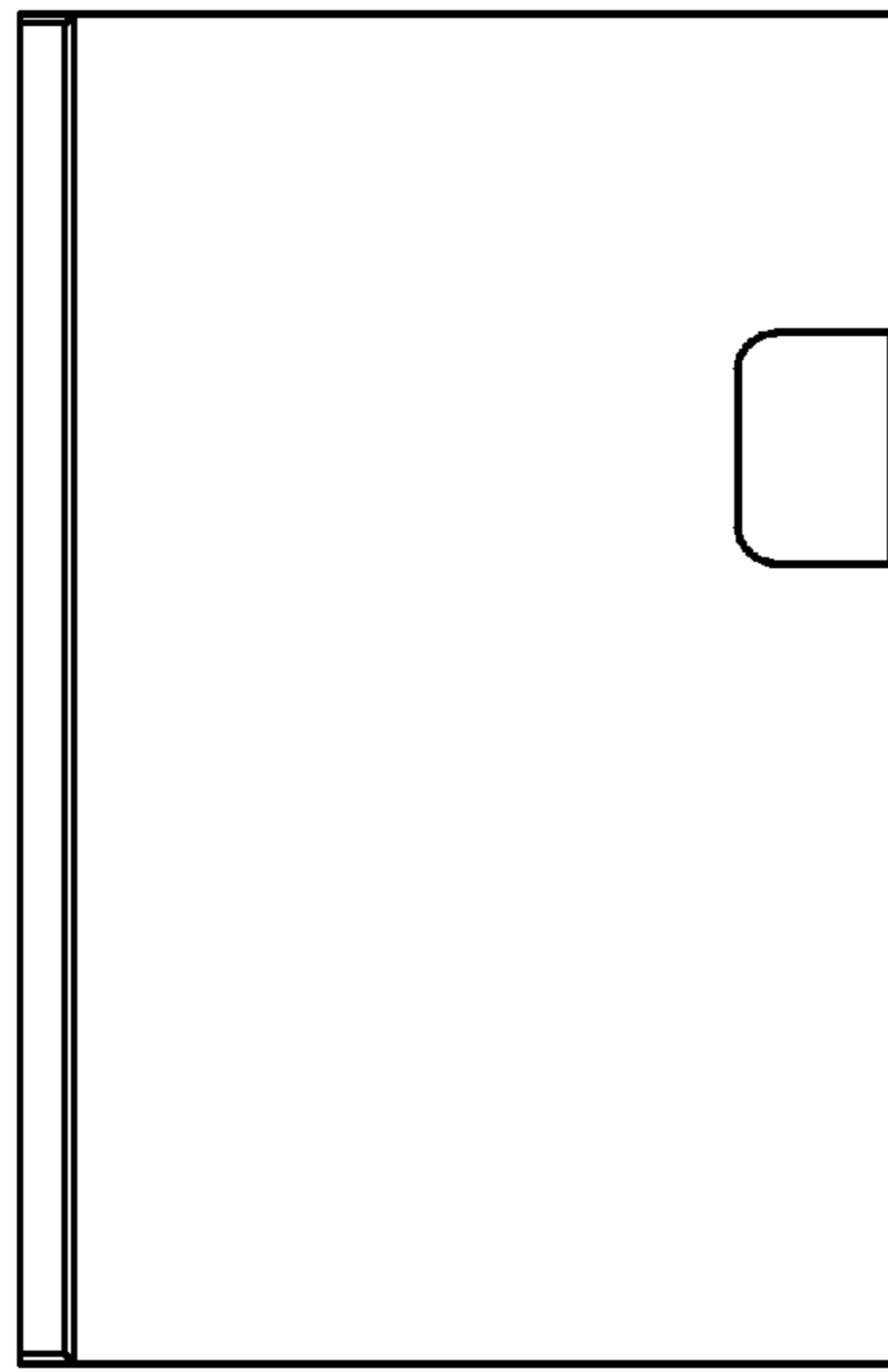

FIG. 77

FIG. 71

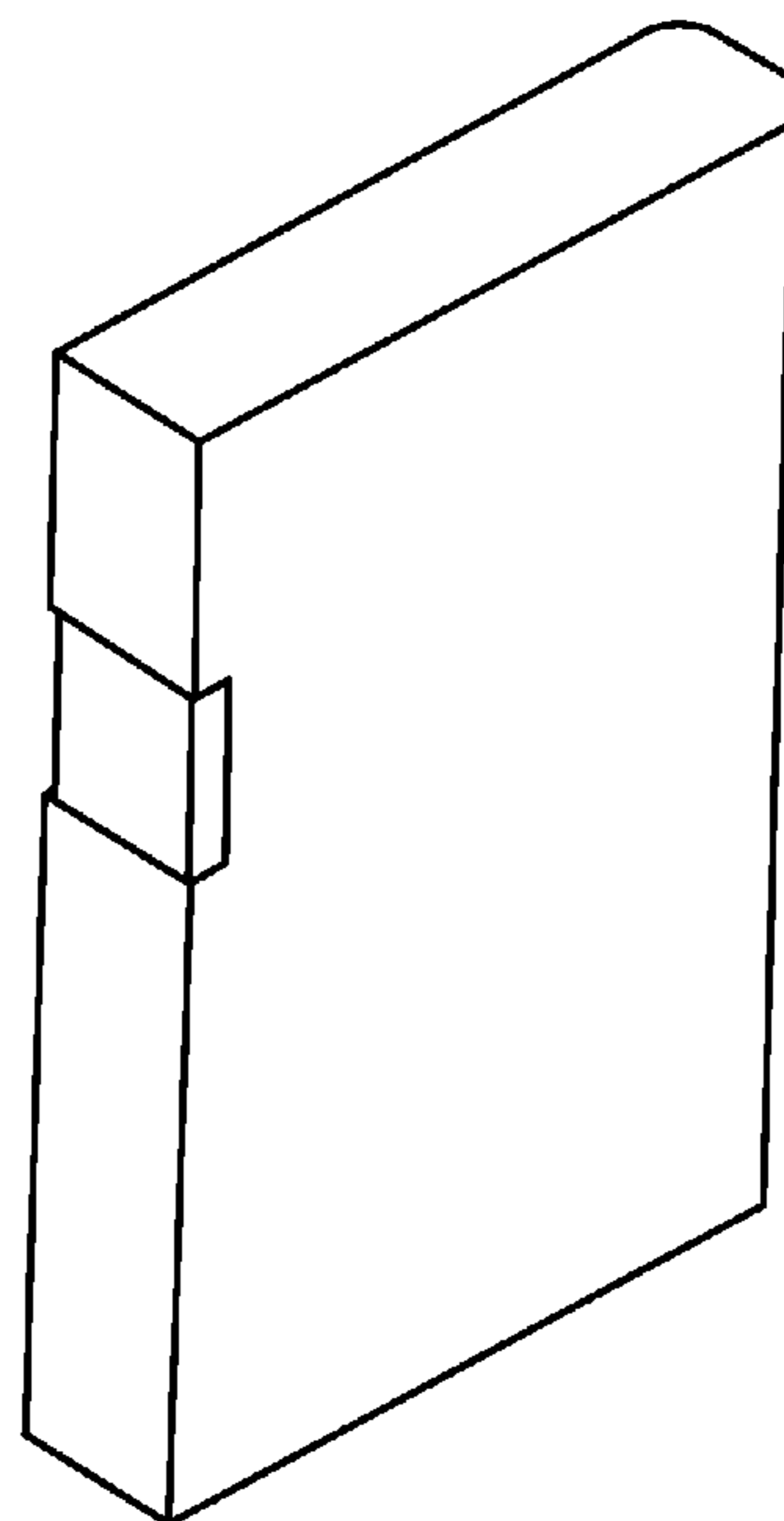





FIG. 72

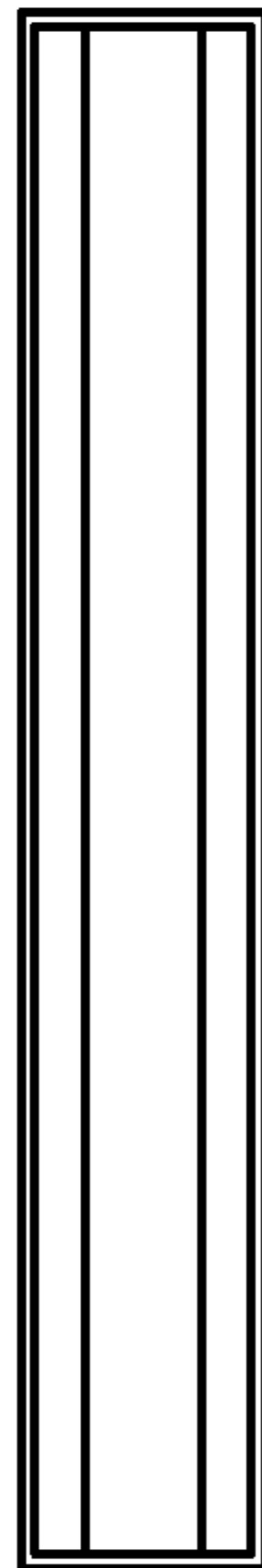

FIG. 73

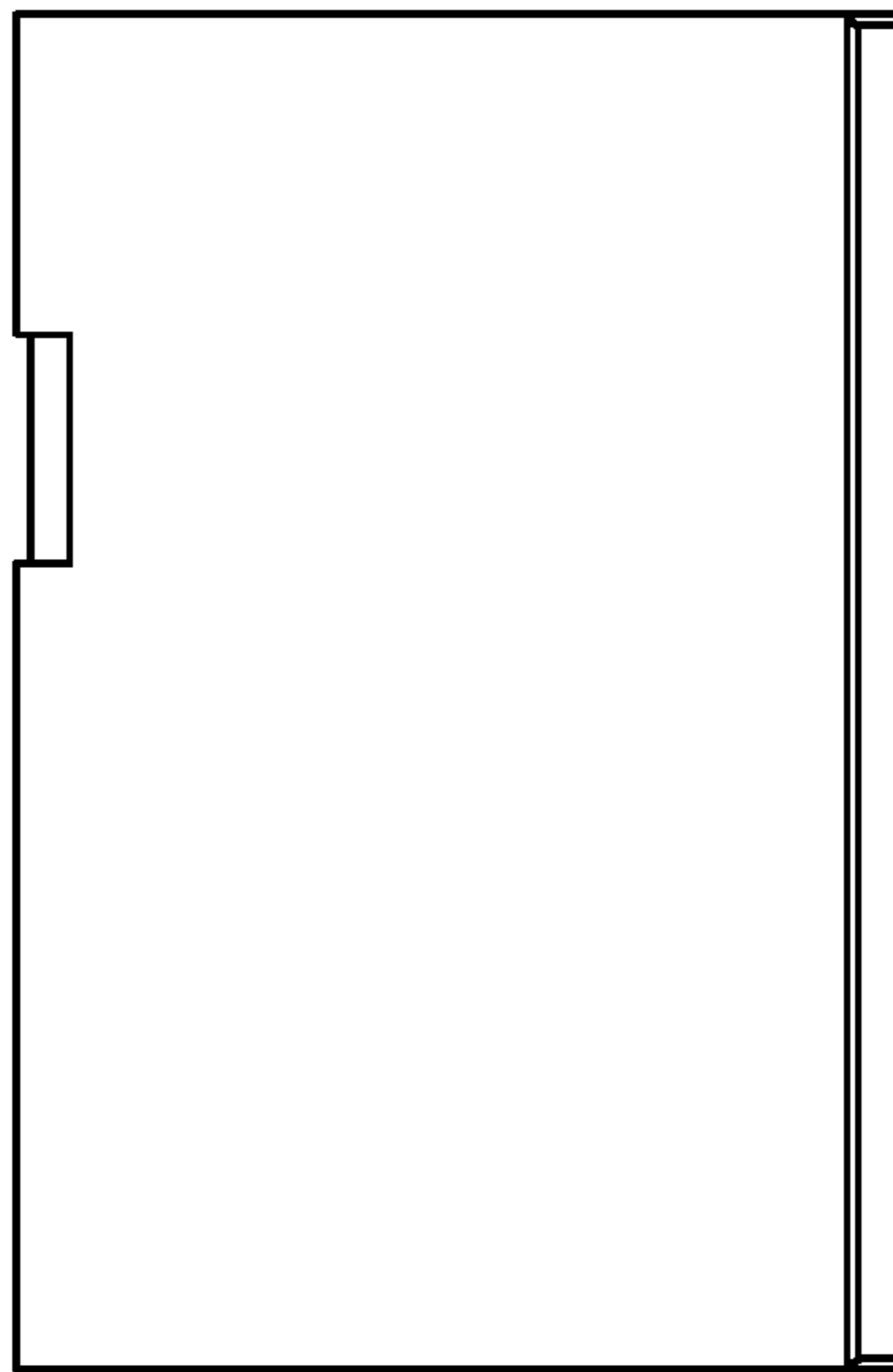

FIG. 74



FIG. 75

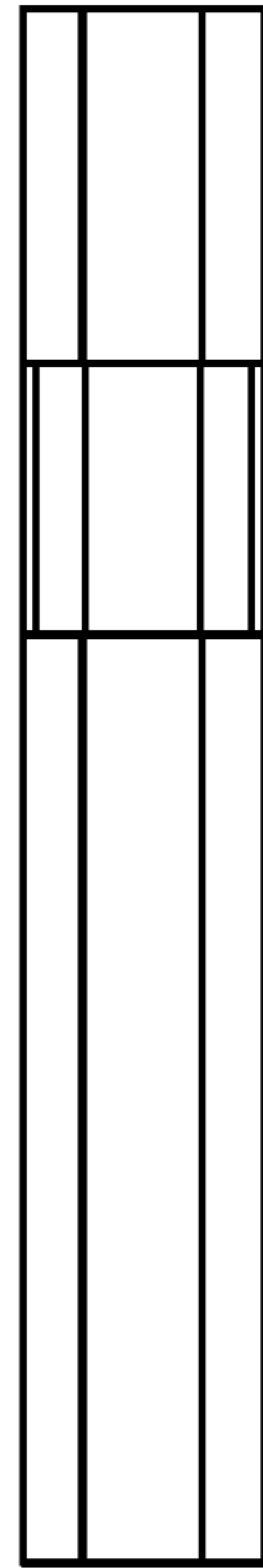

FIG. 83

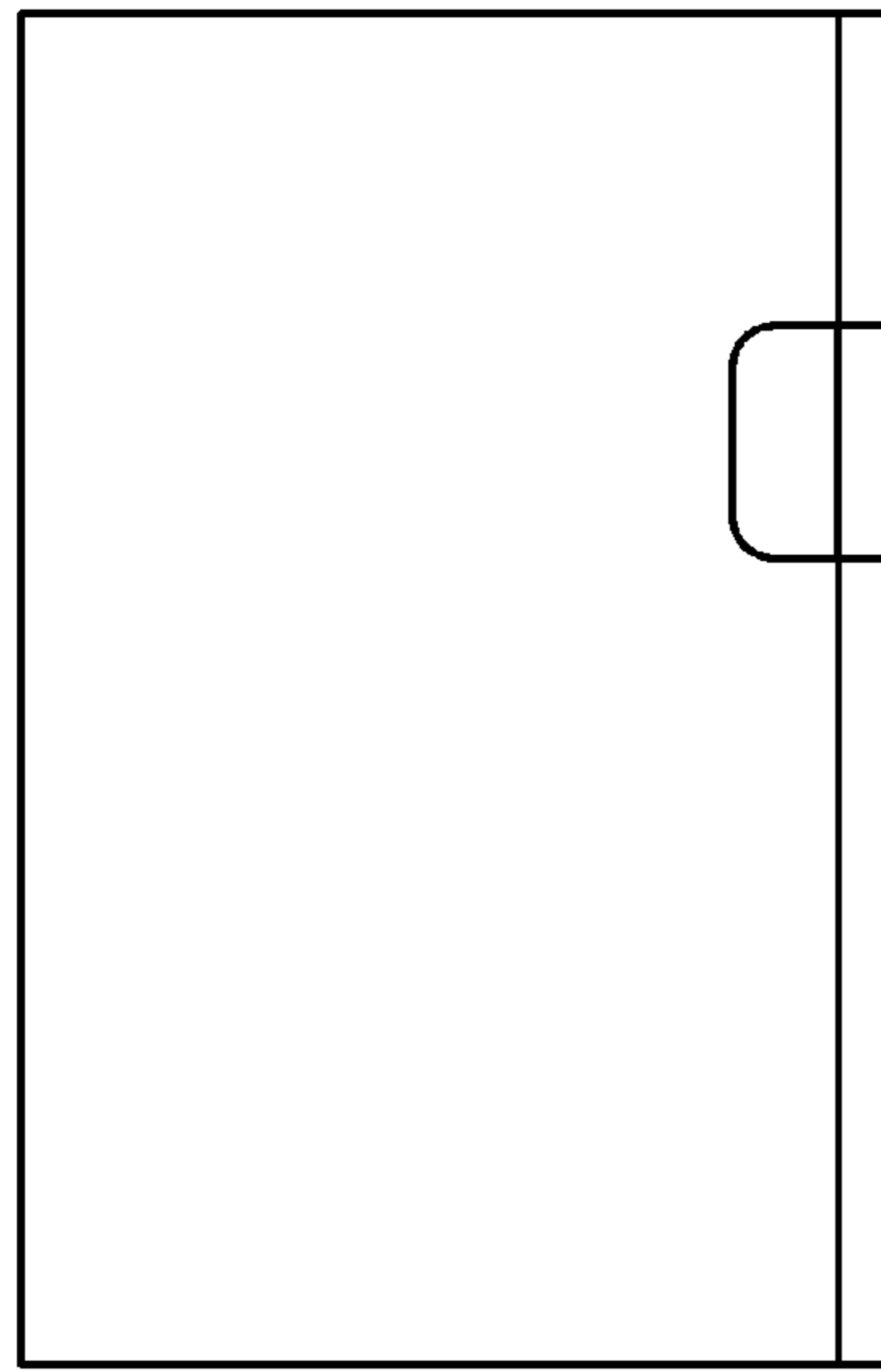

FIG. 84

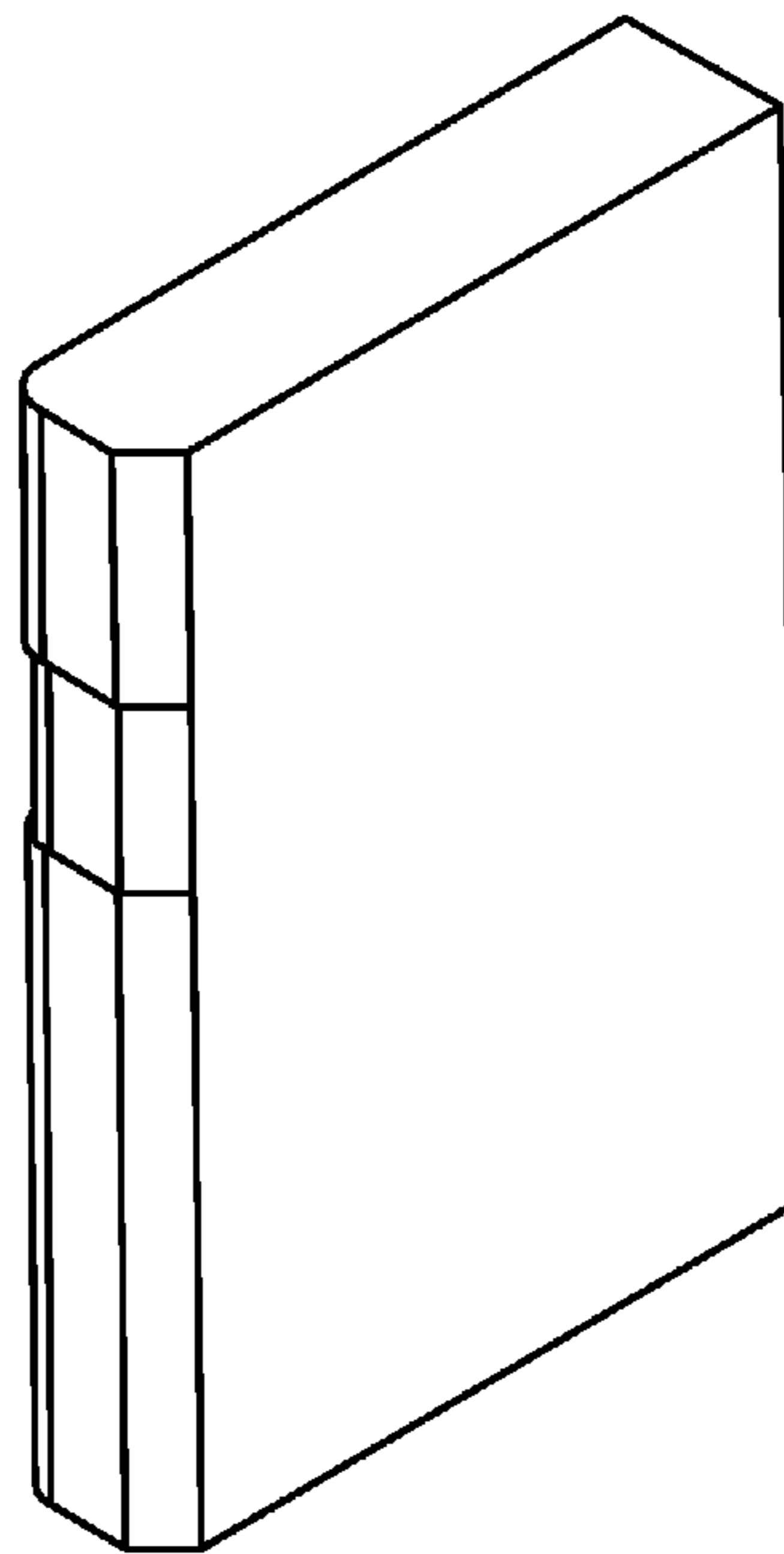

FIG. 78



FIG. 79

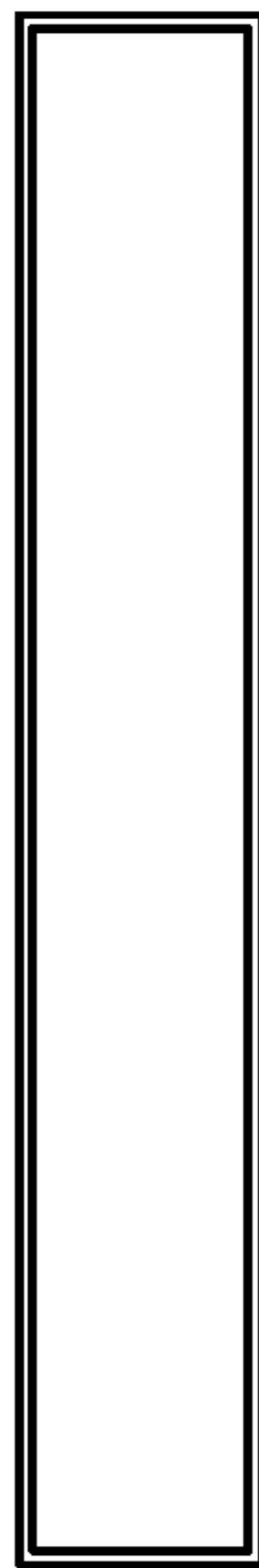

FIG. 80

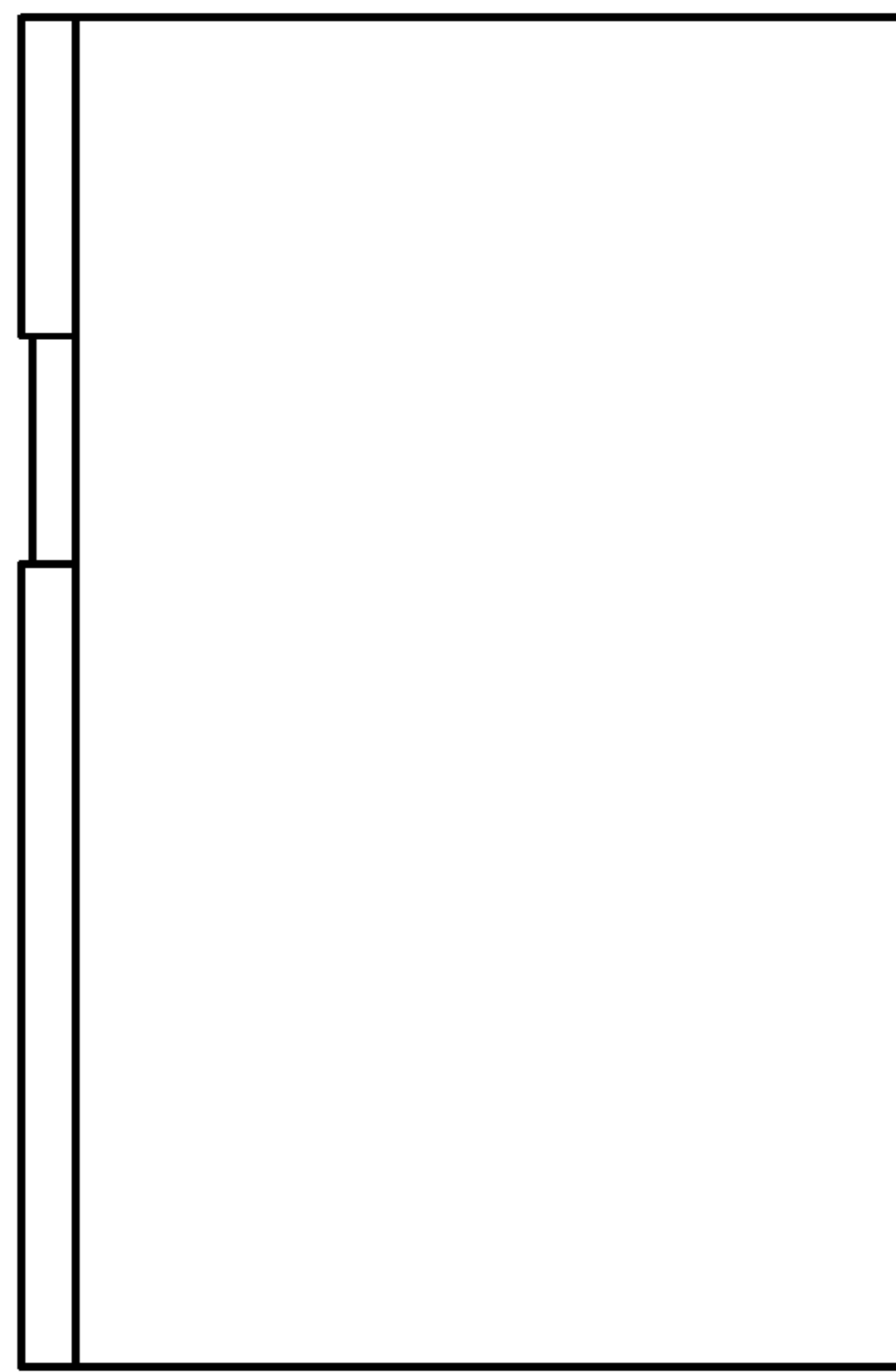

FIG. 81



FIG. 82

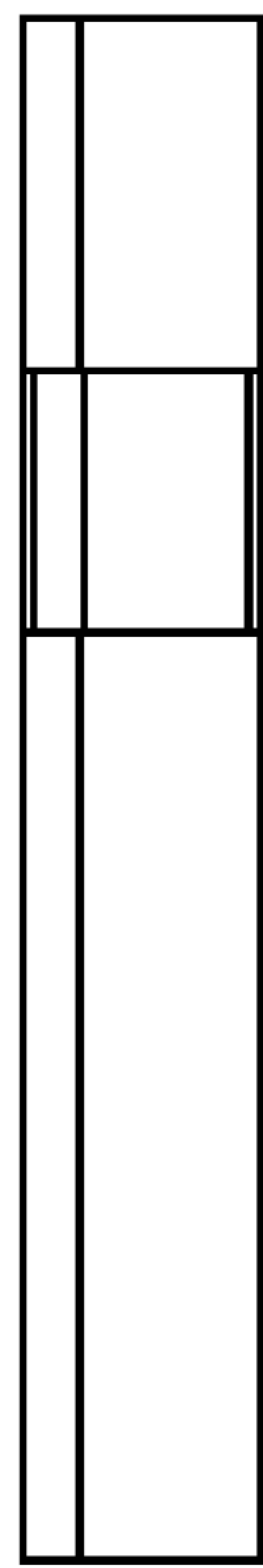

FIG. 90

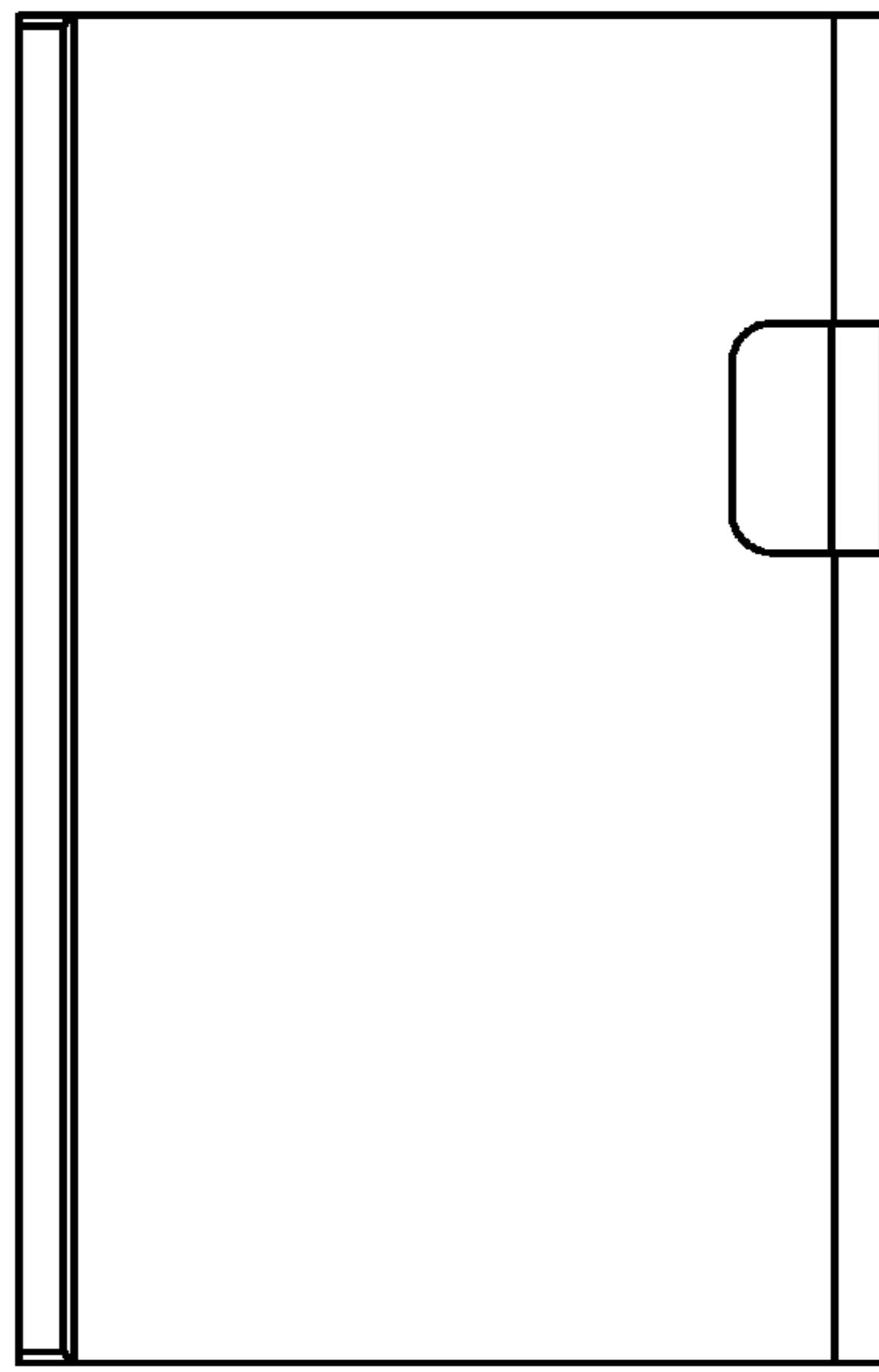

FIG. 91

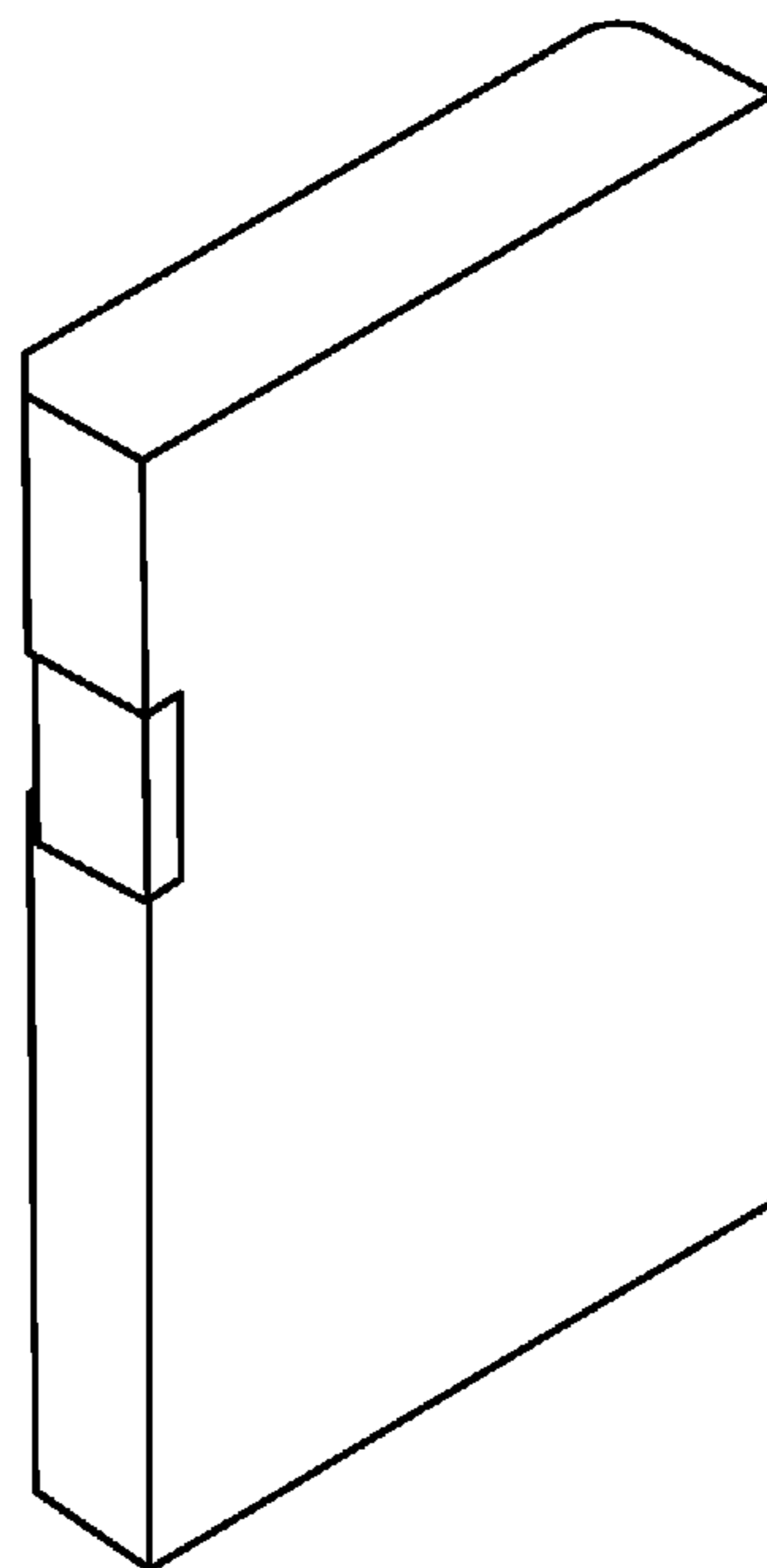

FIG. 85



FIG. 86

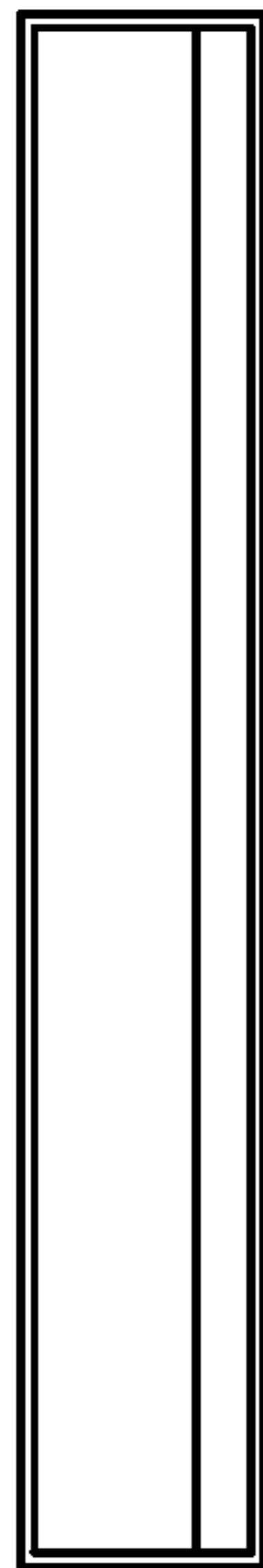

FIG. 87

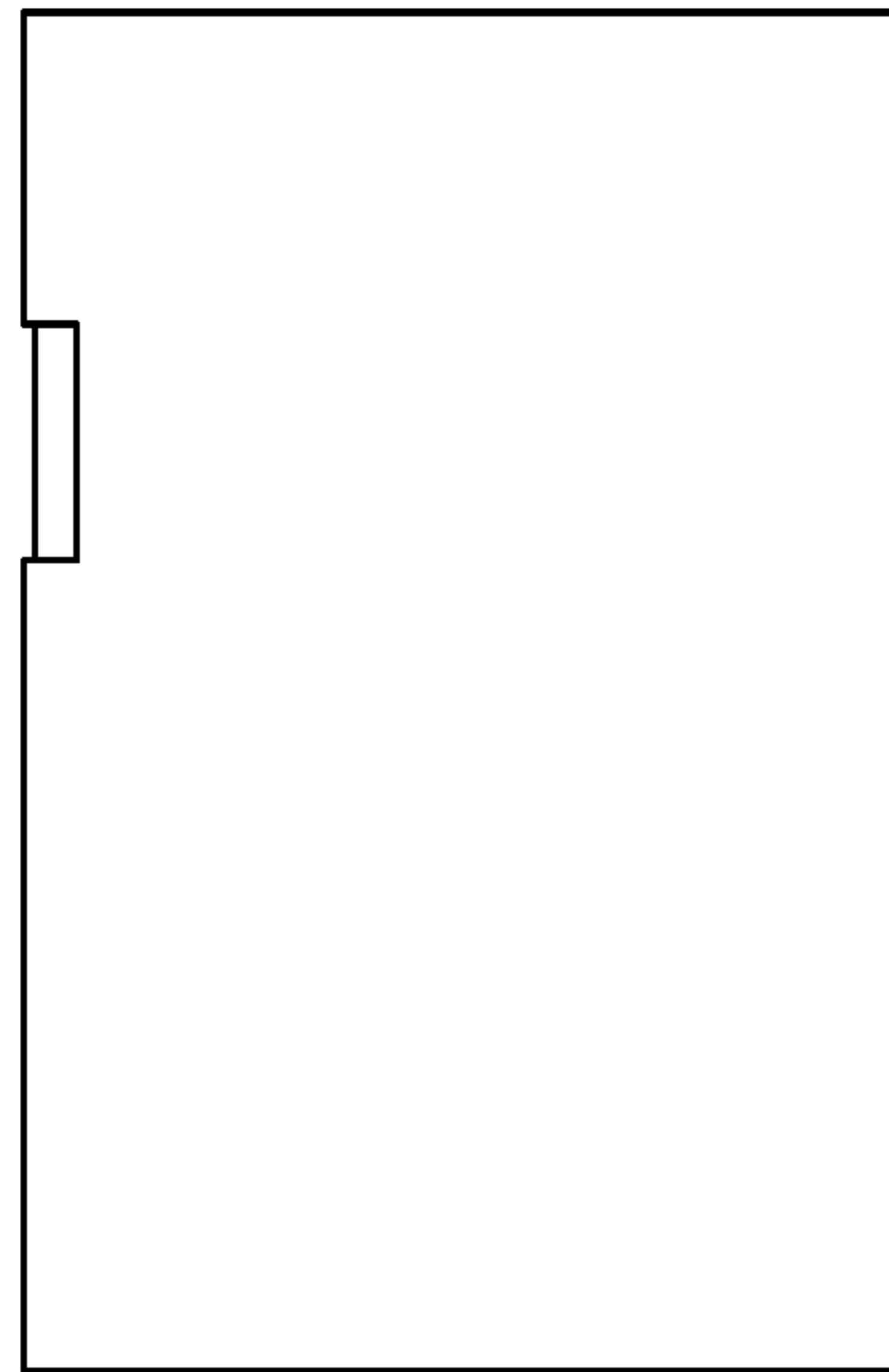

FIG. 88



FIG. 89

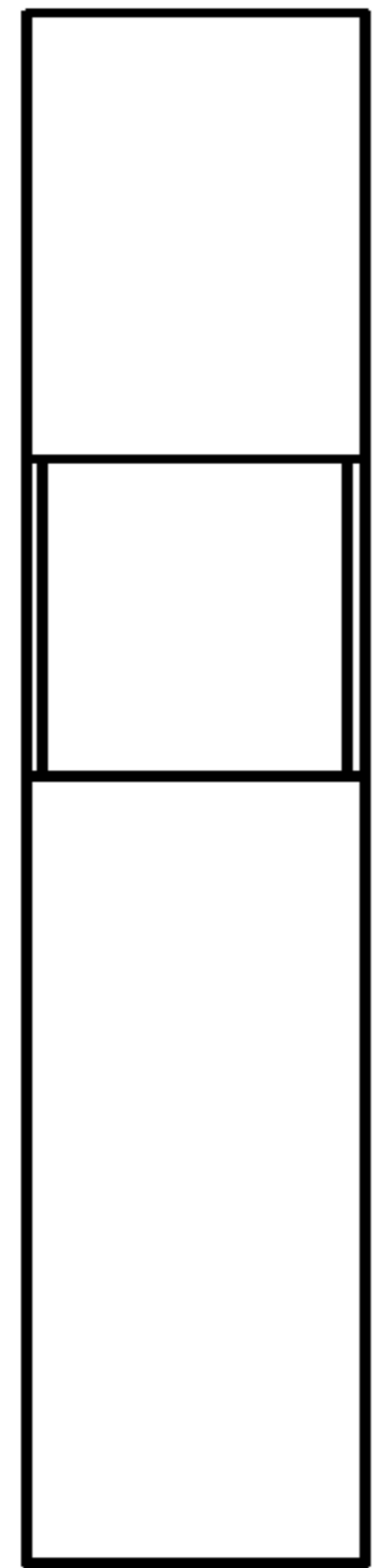

FIG. 97

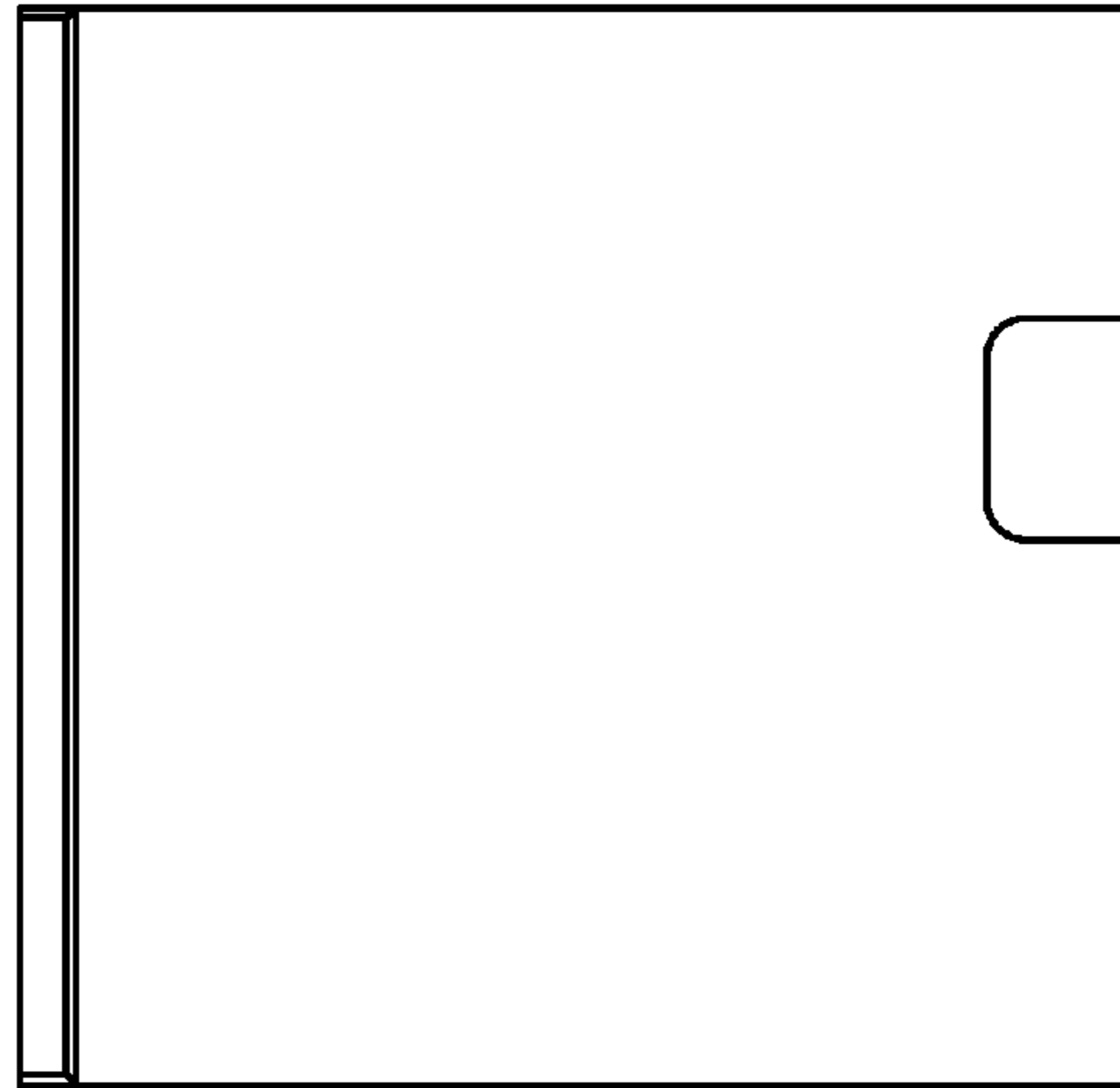

FIG. 98

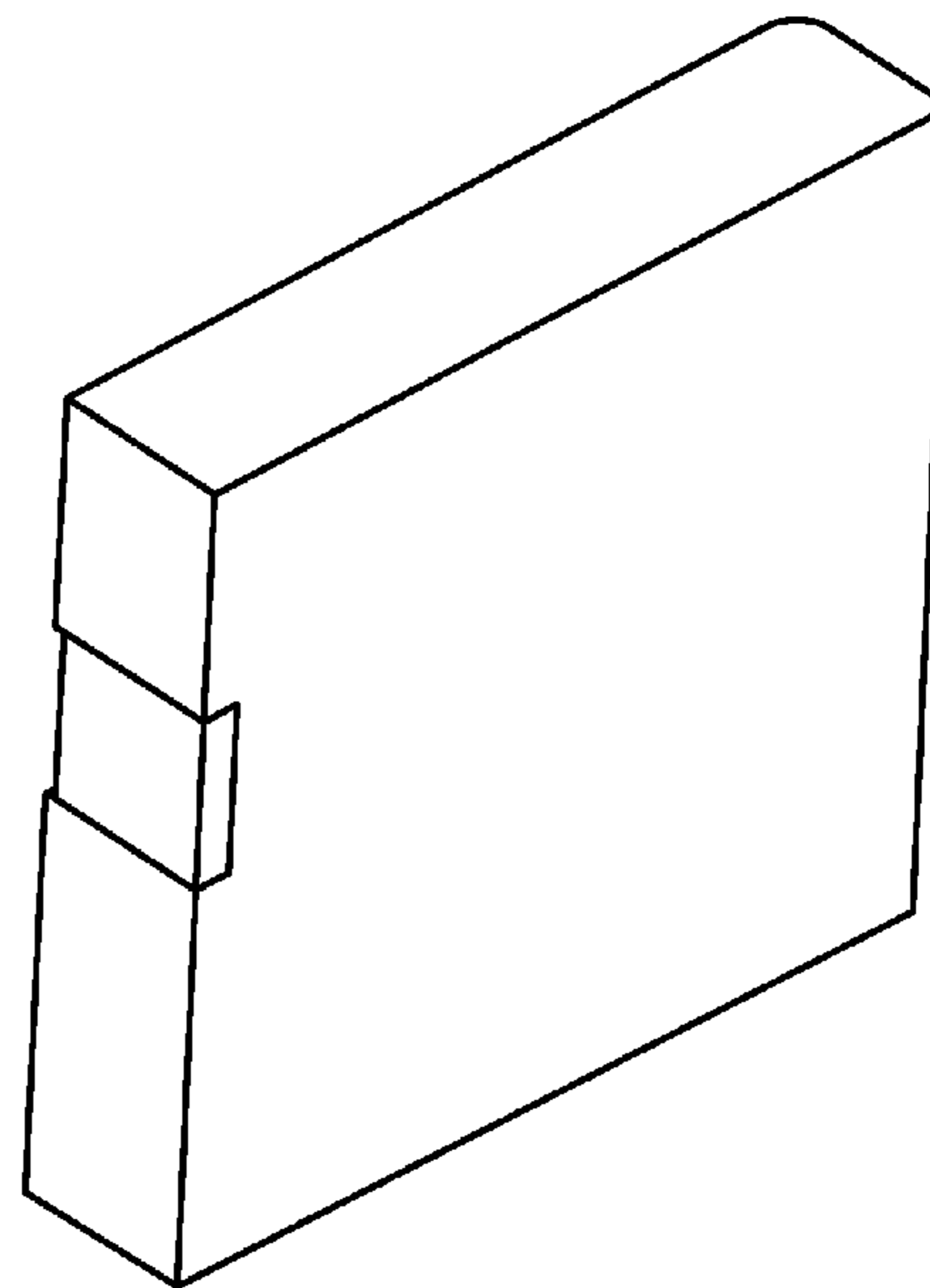

FIG. 92



FIG. 93

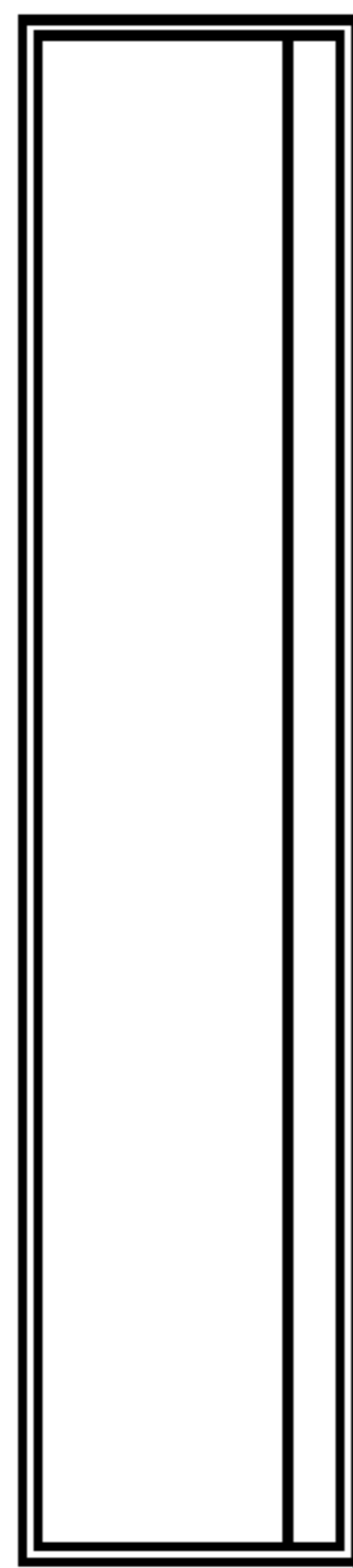

FIG. 94

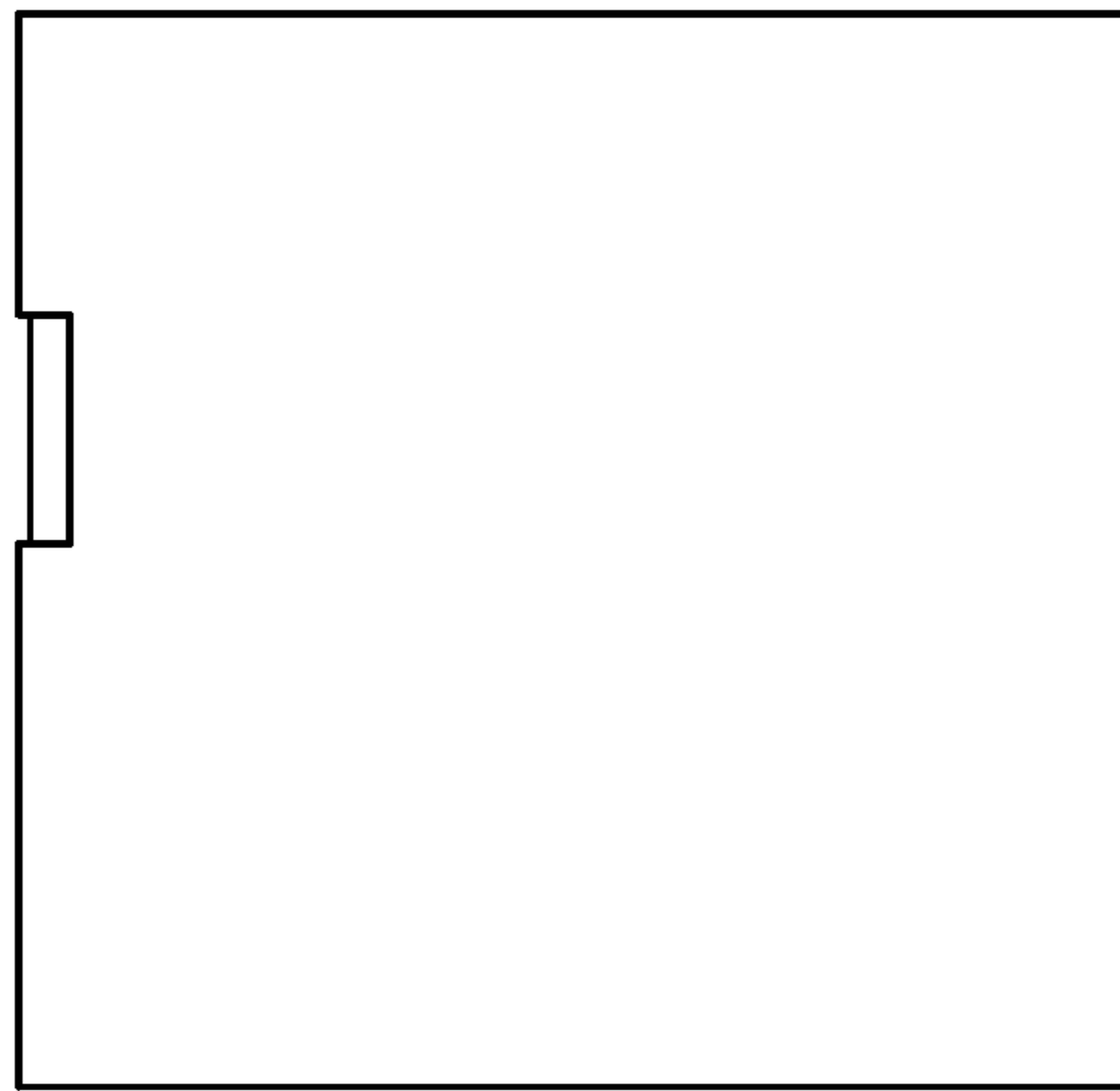

FIG. 95



FIG. 96

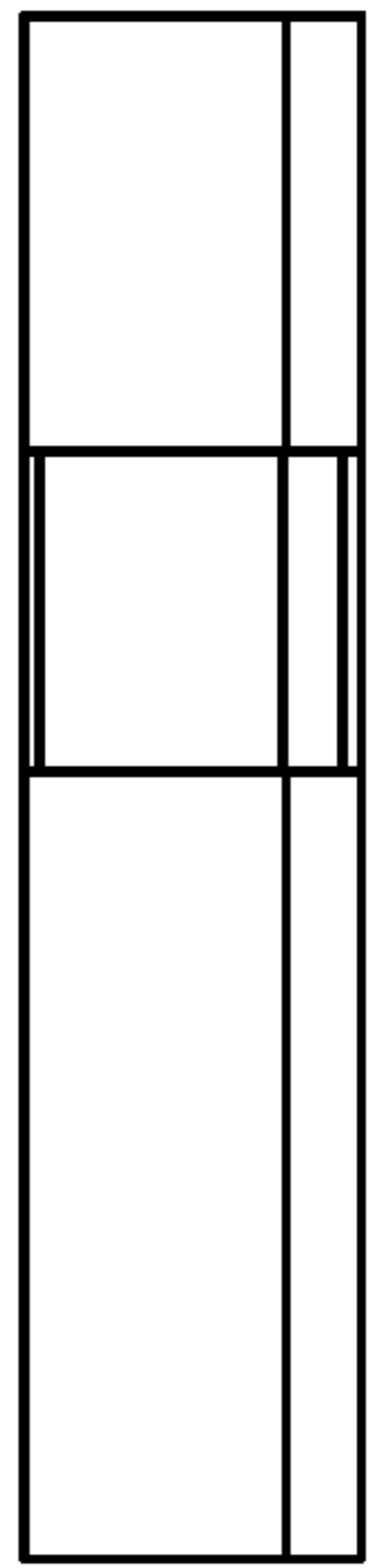

FIG. 104

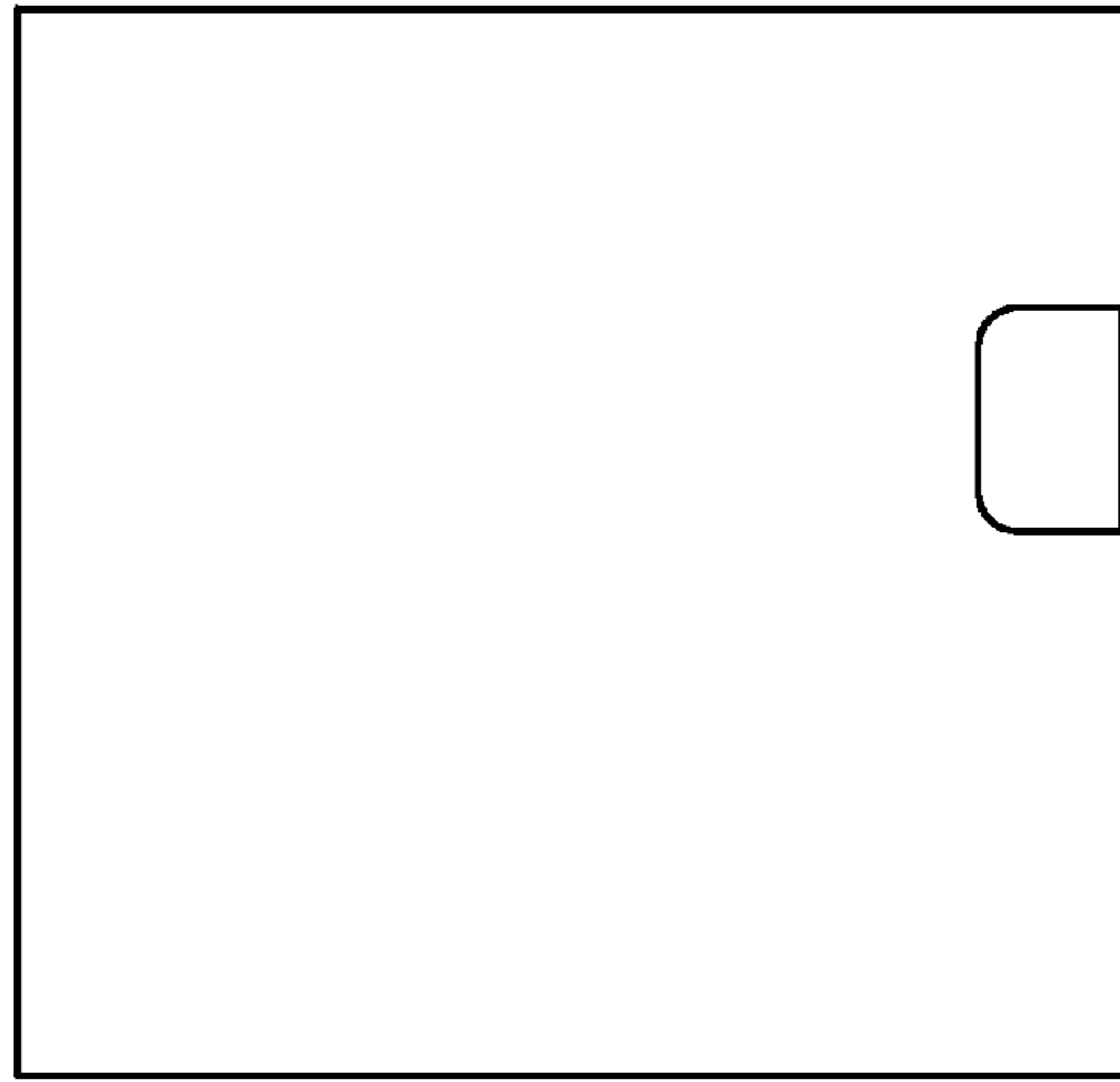

FIG. 105

FIG. 99

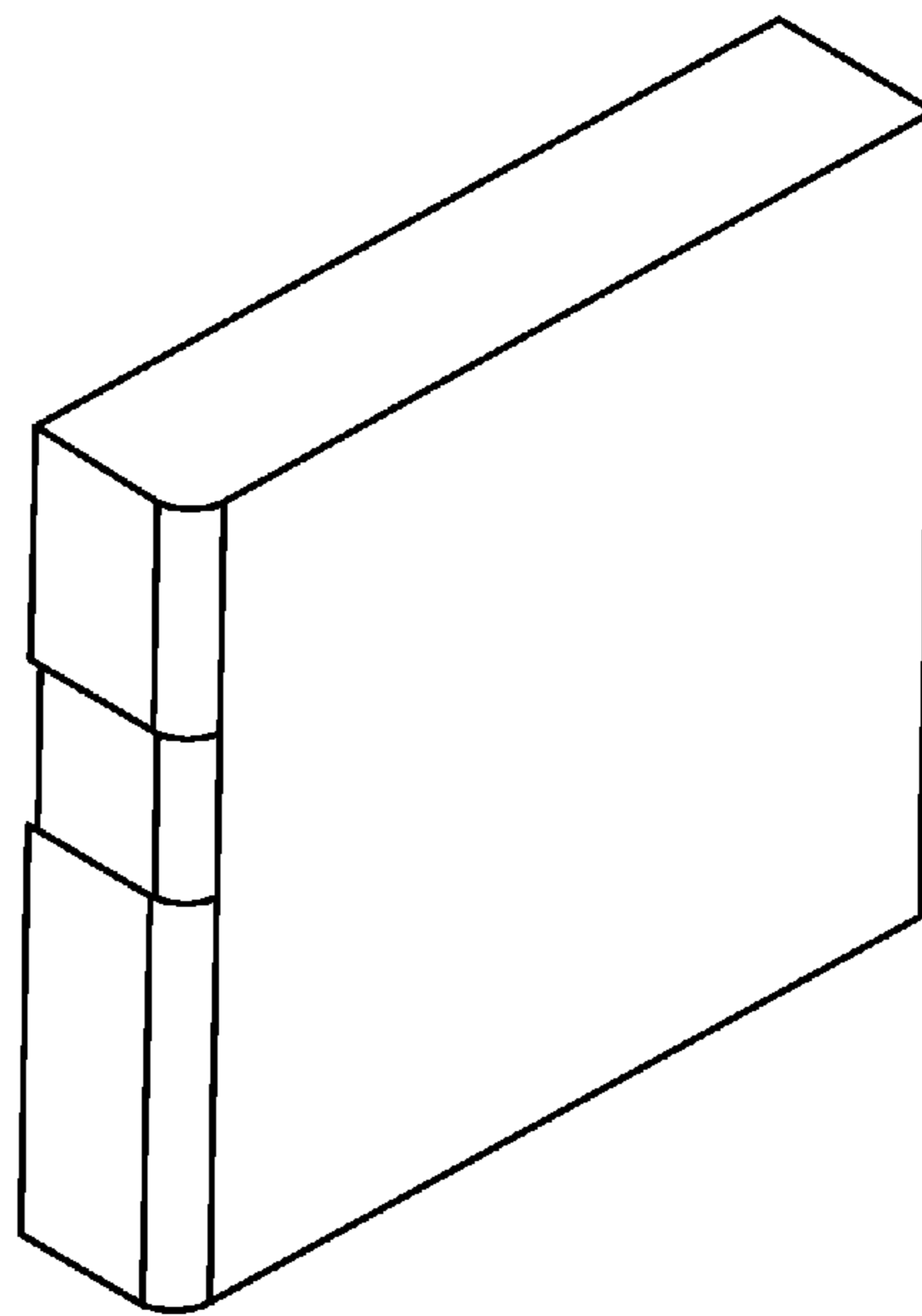





FIG. 100

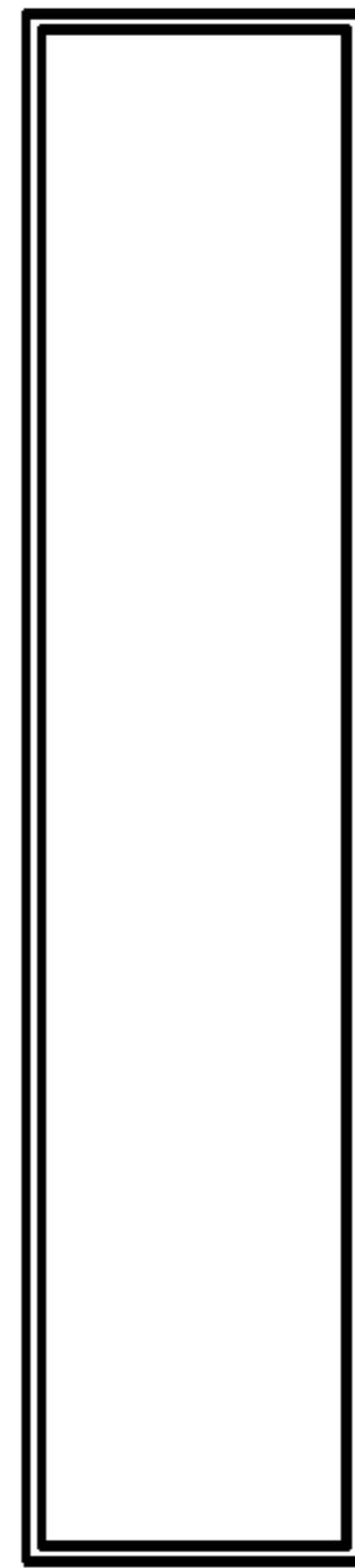

FIG. 101

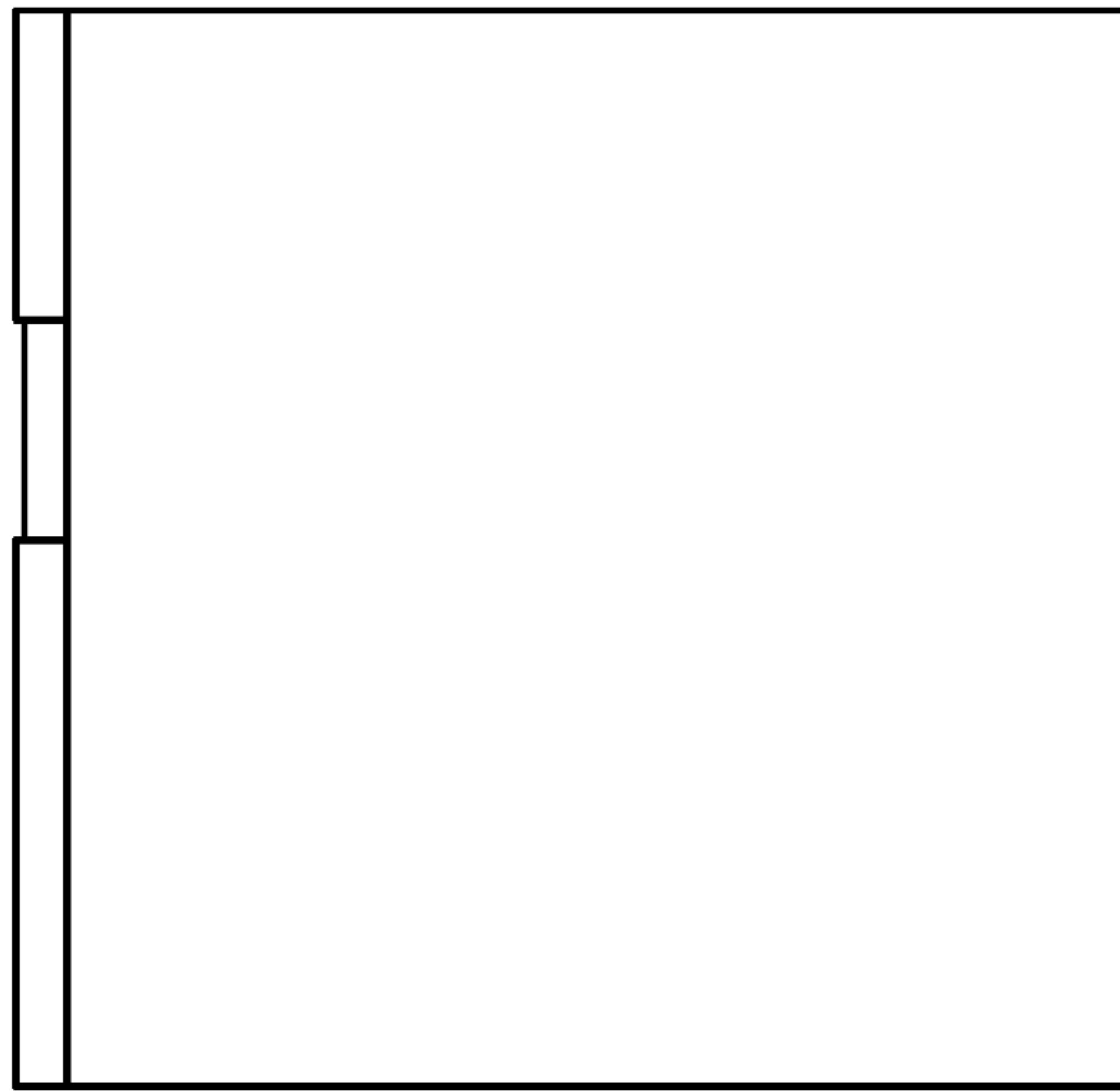

FIG. 102



FIG. 103

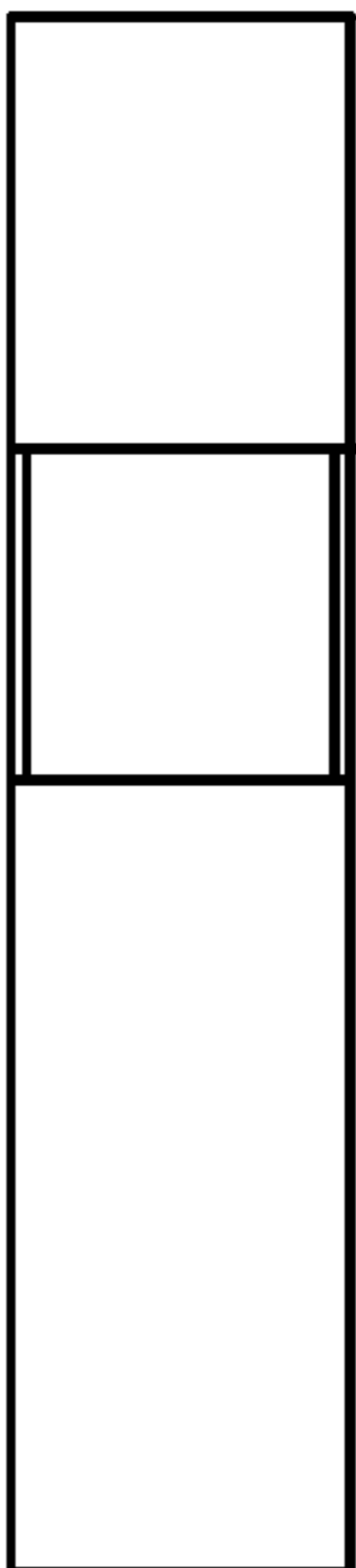

FIG. 111

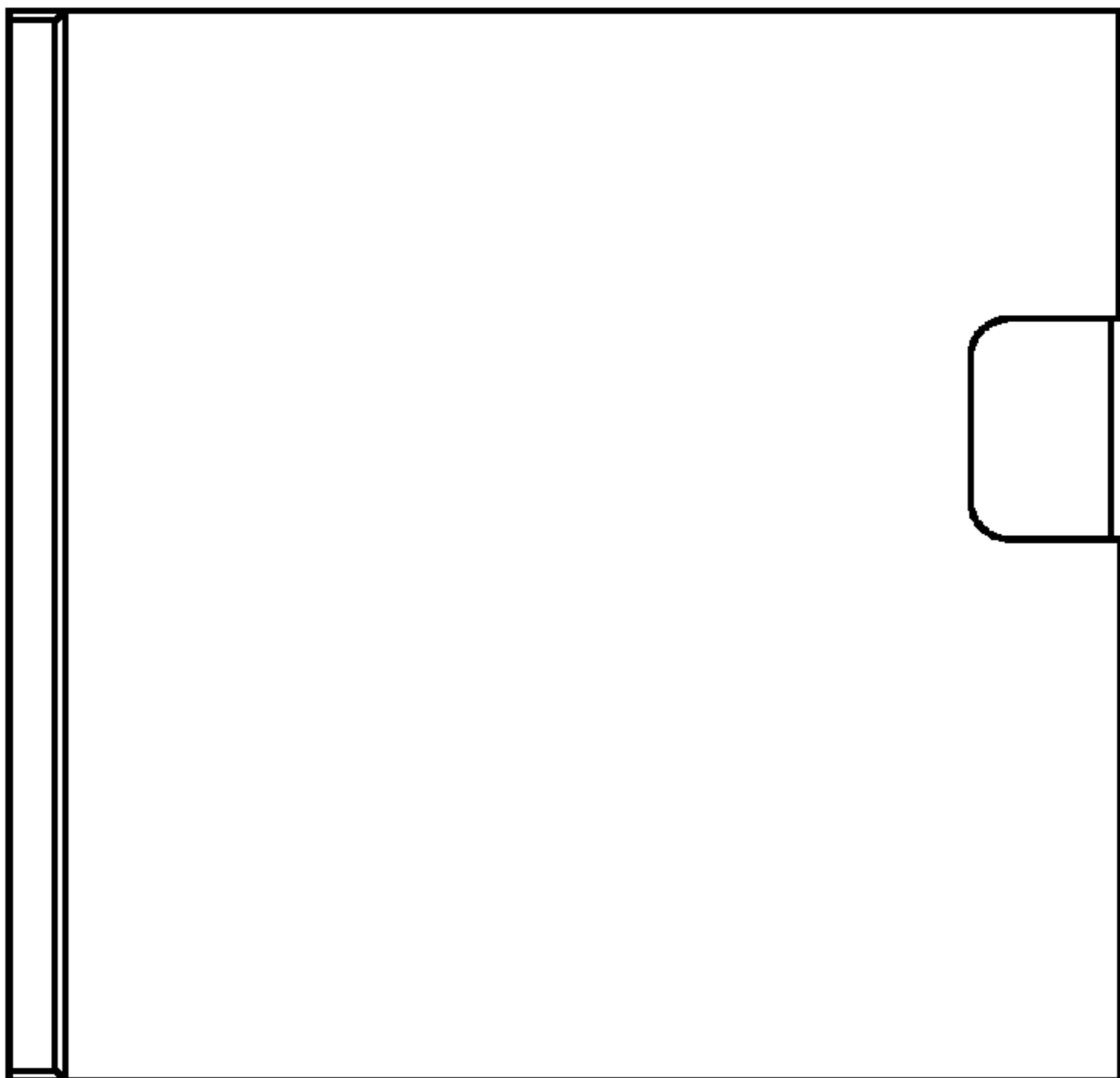

FIG. 112

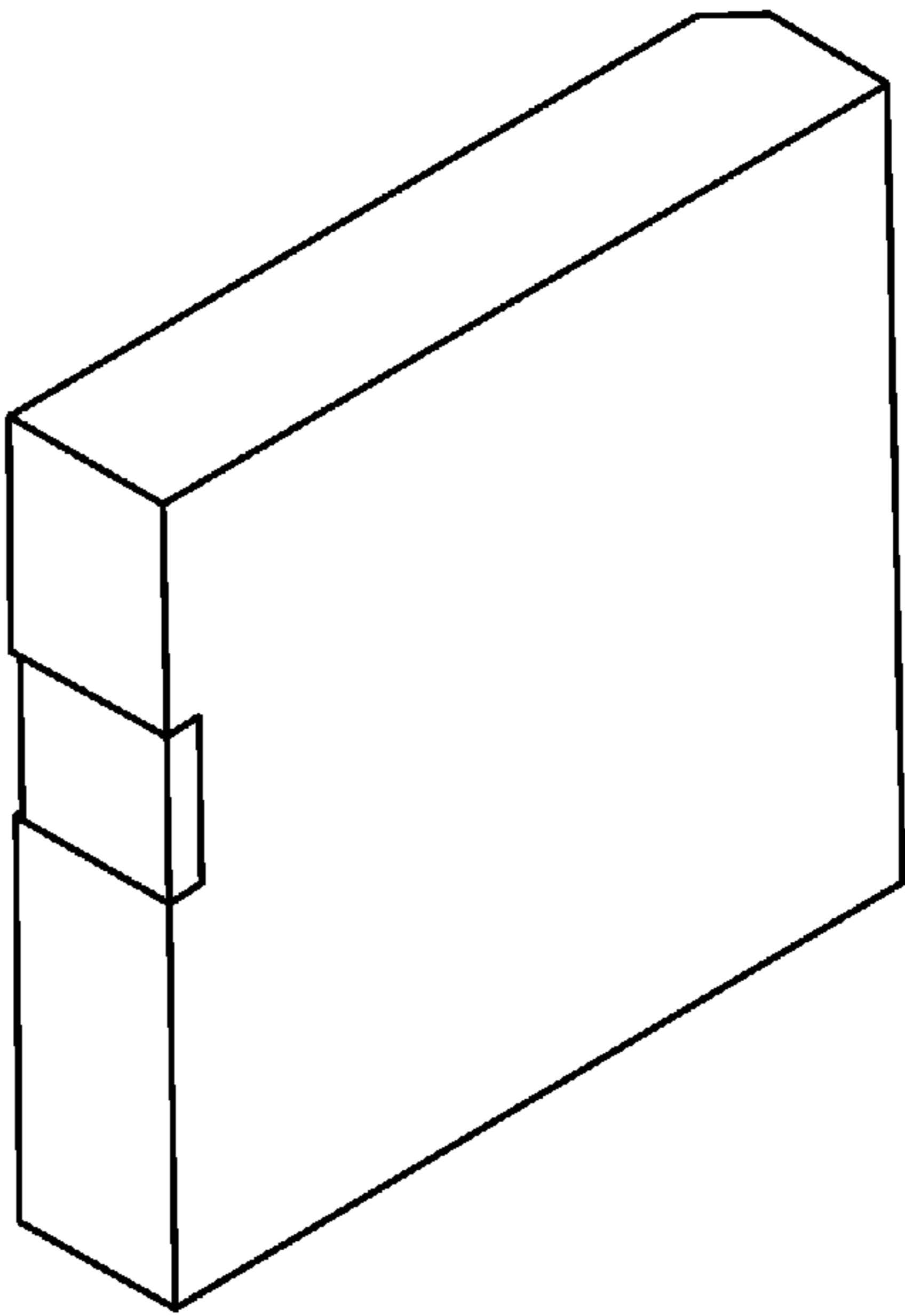

FIG. 106



FIG. 107

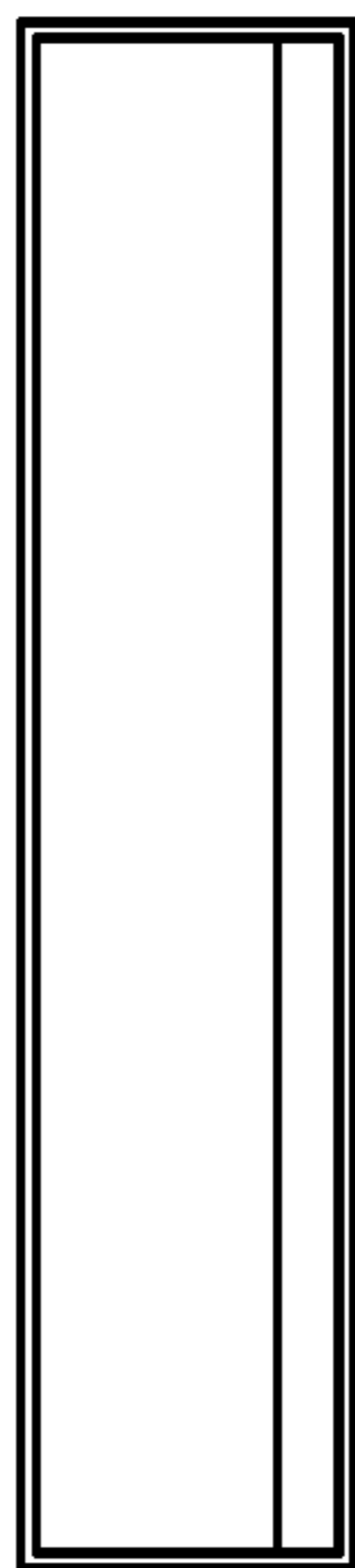

FIG. 108

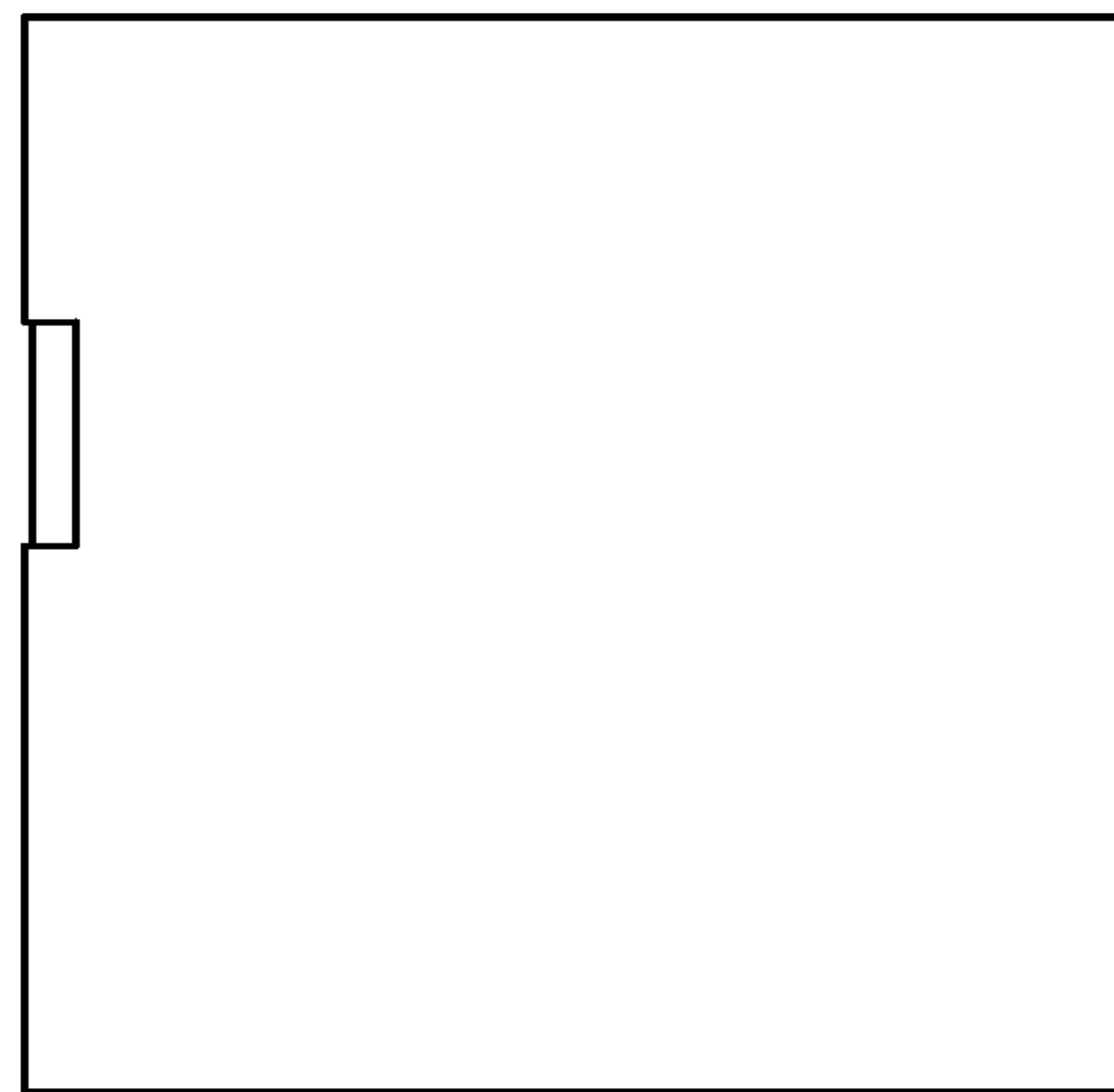

FIG. 109



FIG. 110

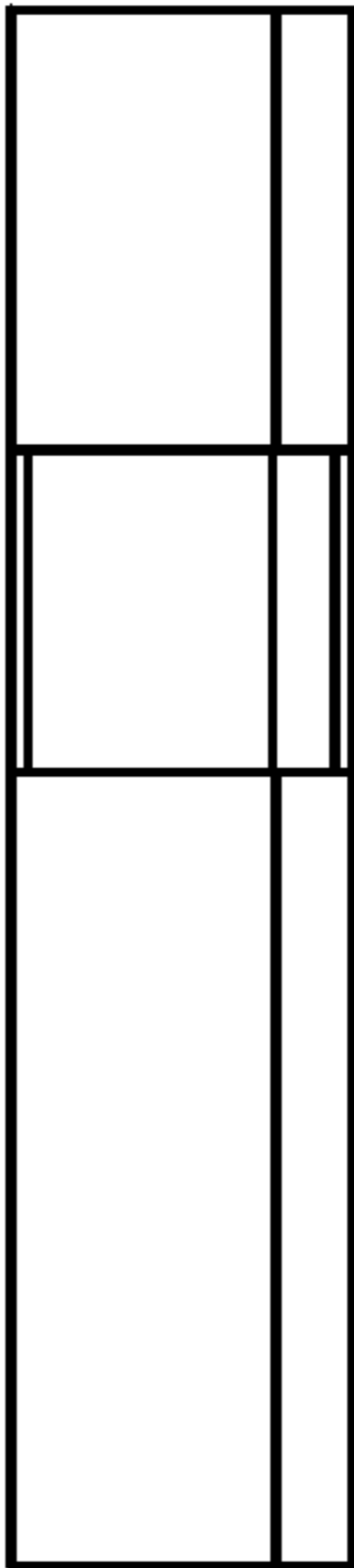

FIG. 118

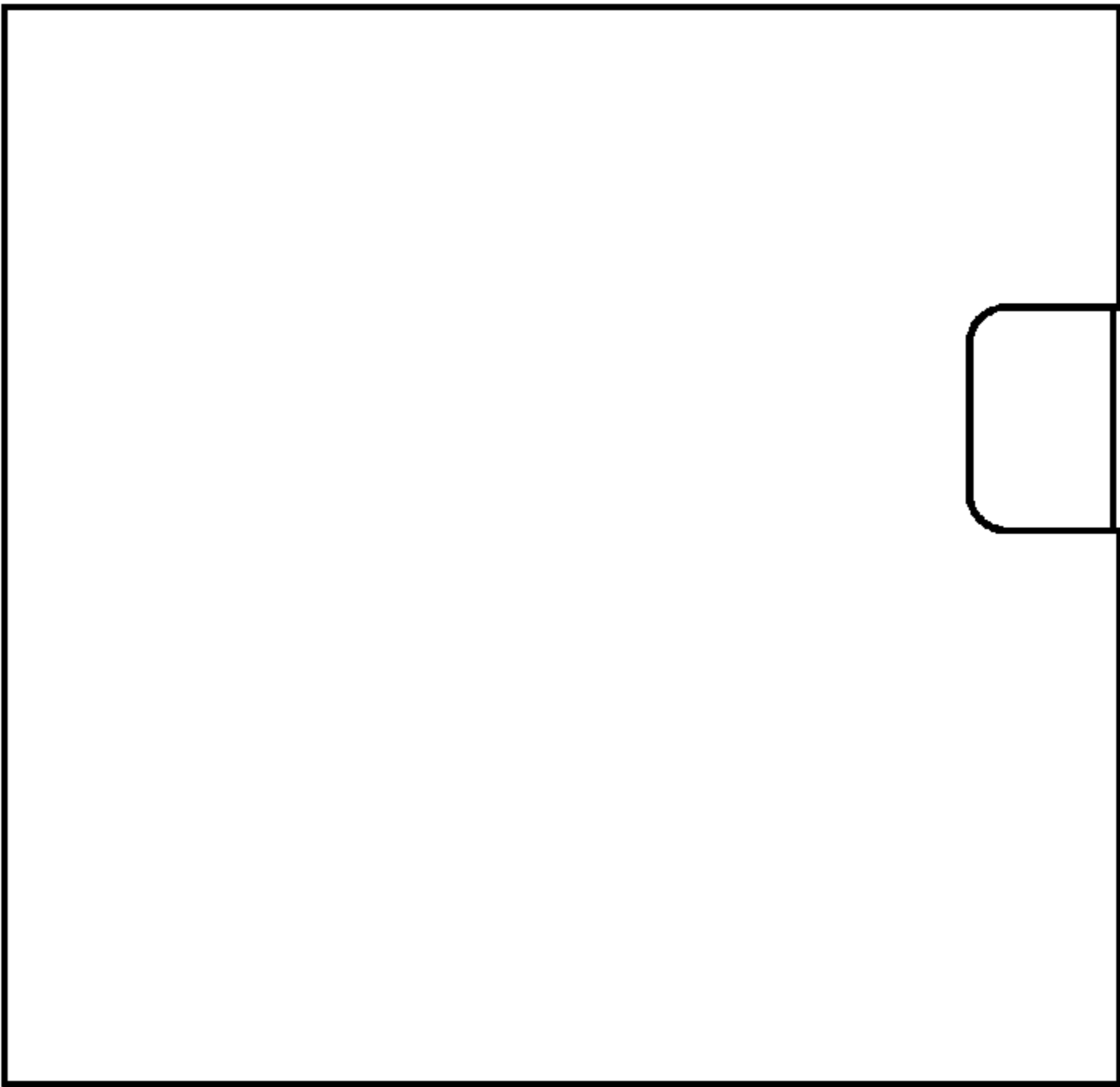

FIG. 119

FIG. 113

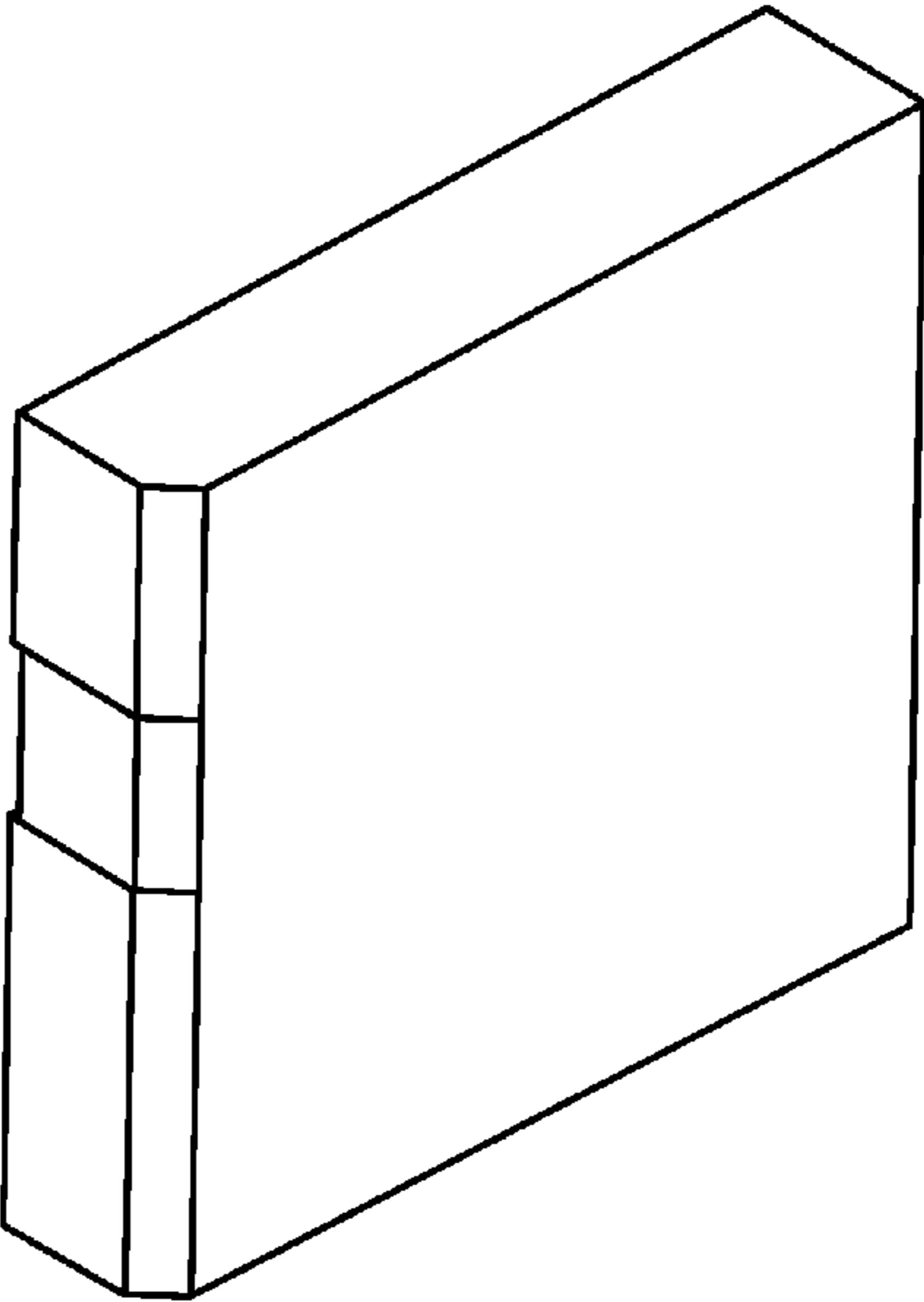



FIG. 114

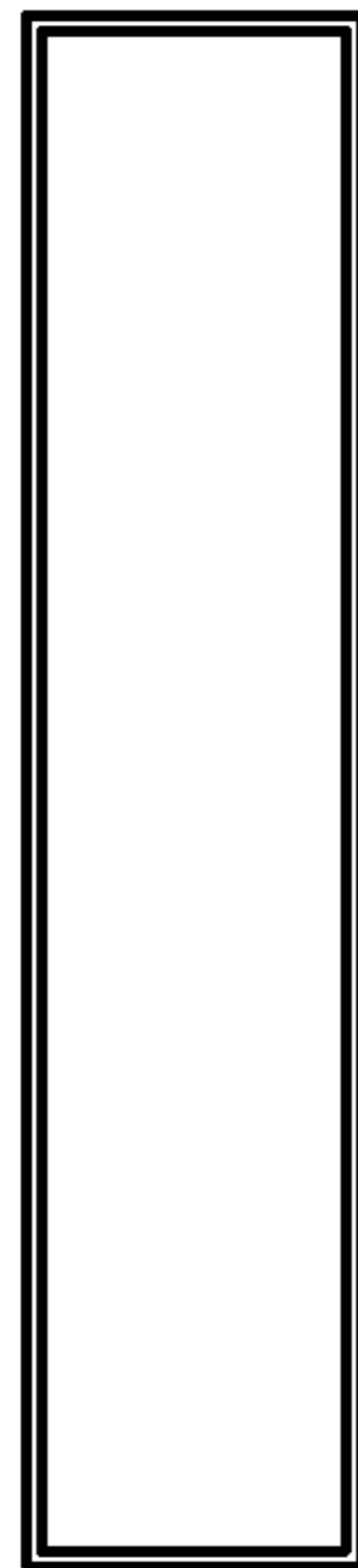

FIG. 115

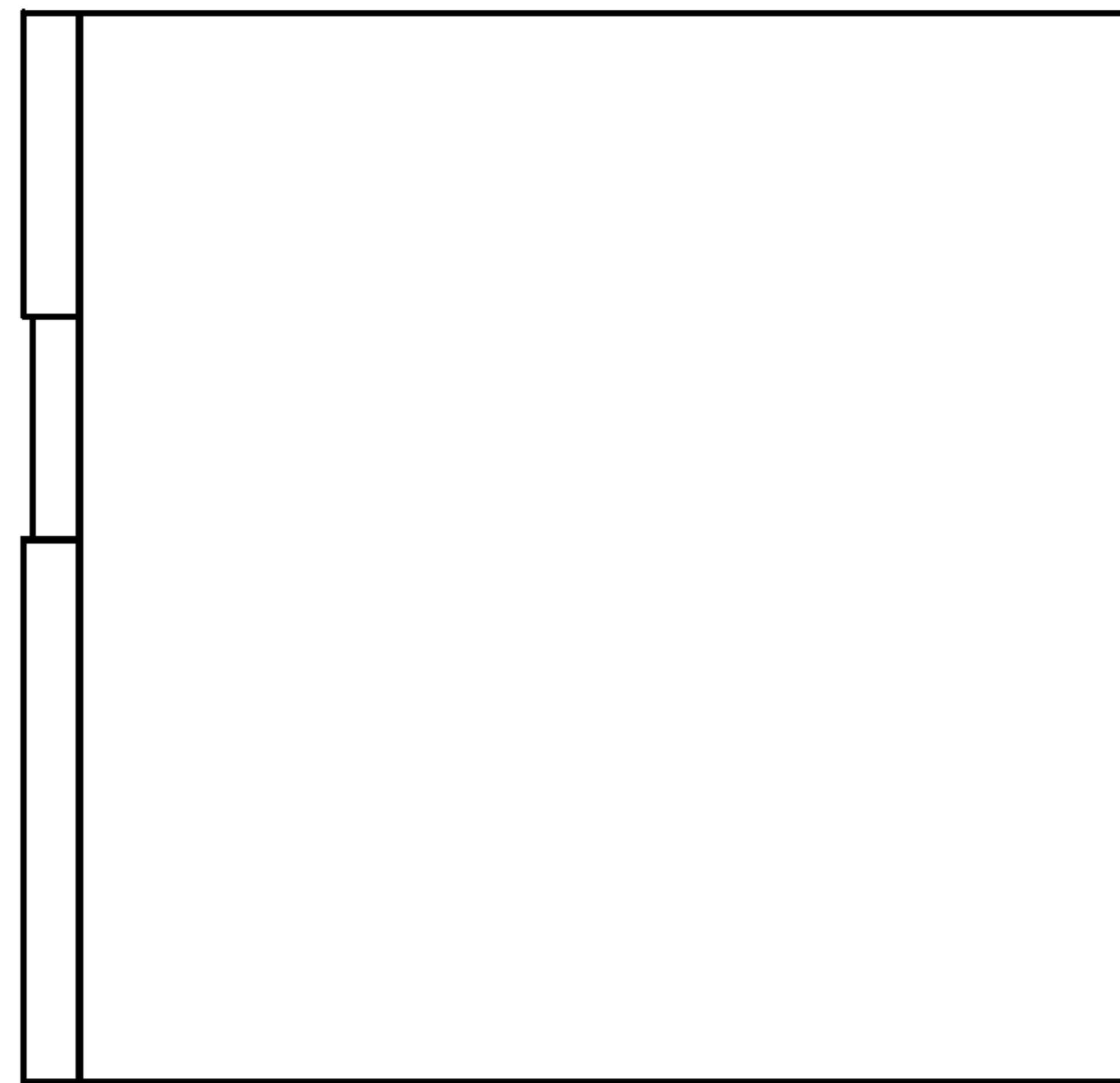

FIG. 116



FIG. 117

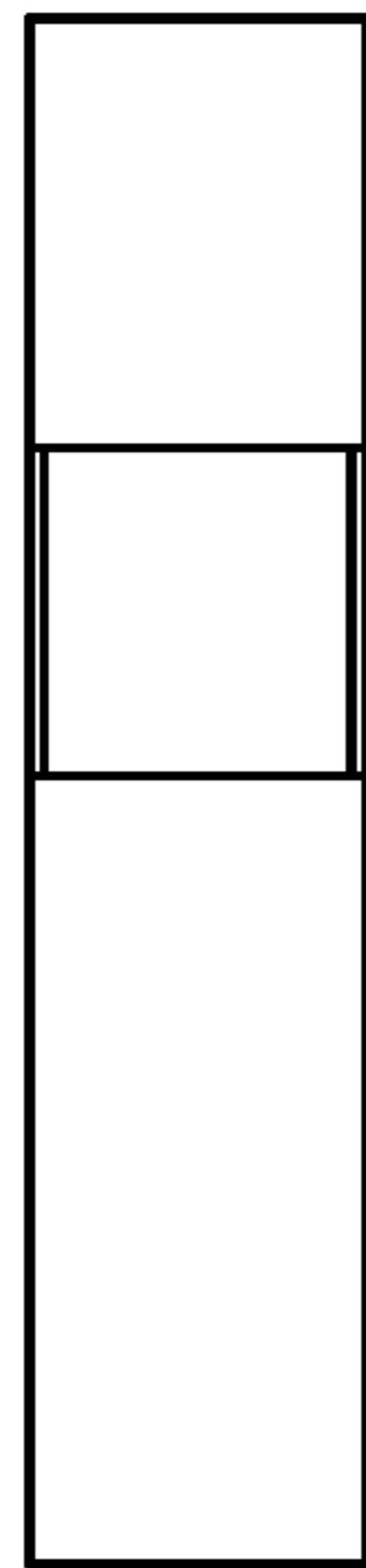

FIG. 125

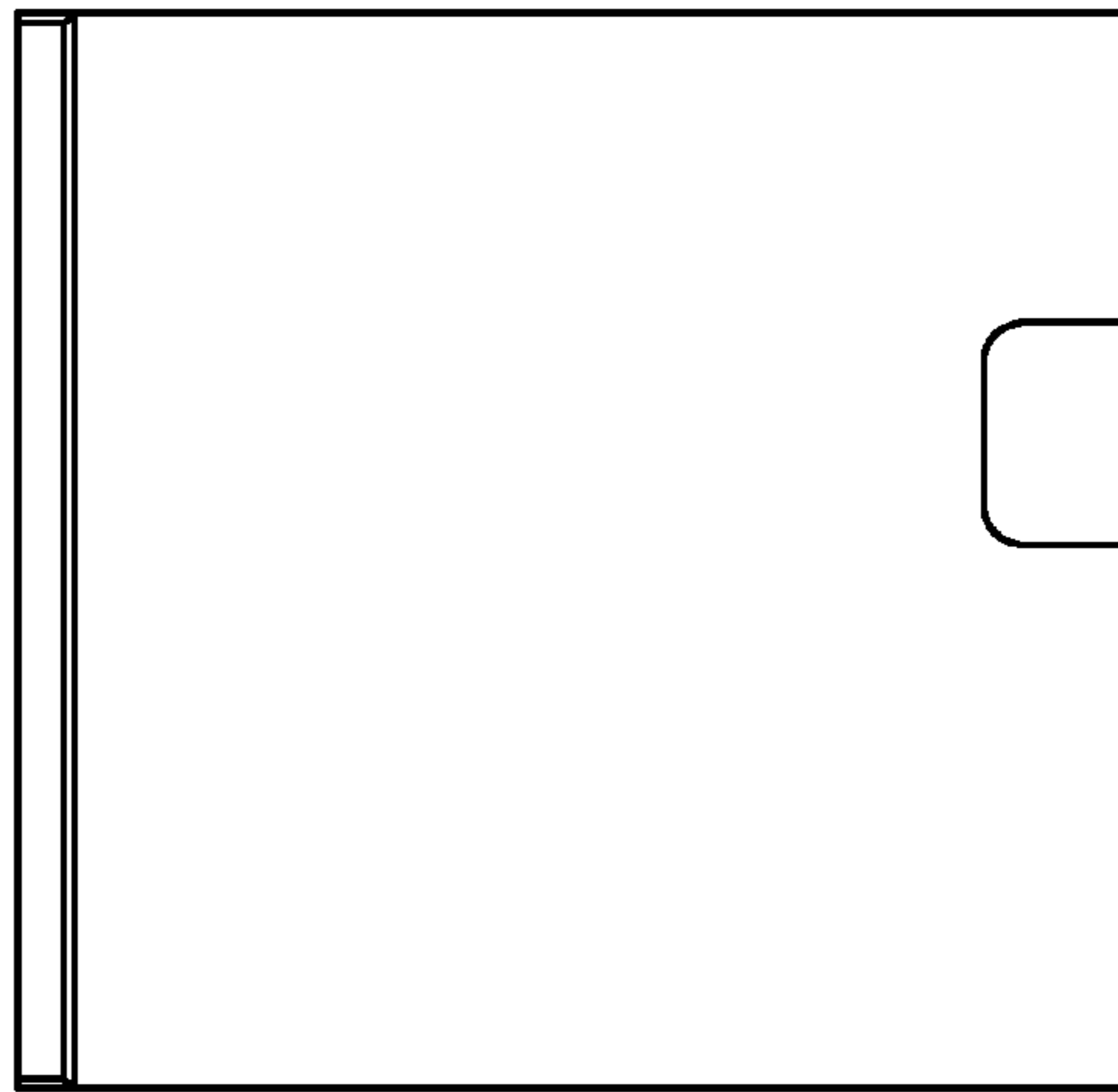

FIG. 126

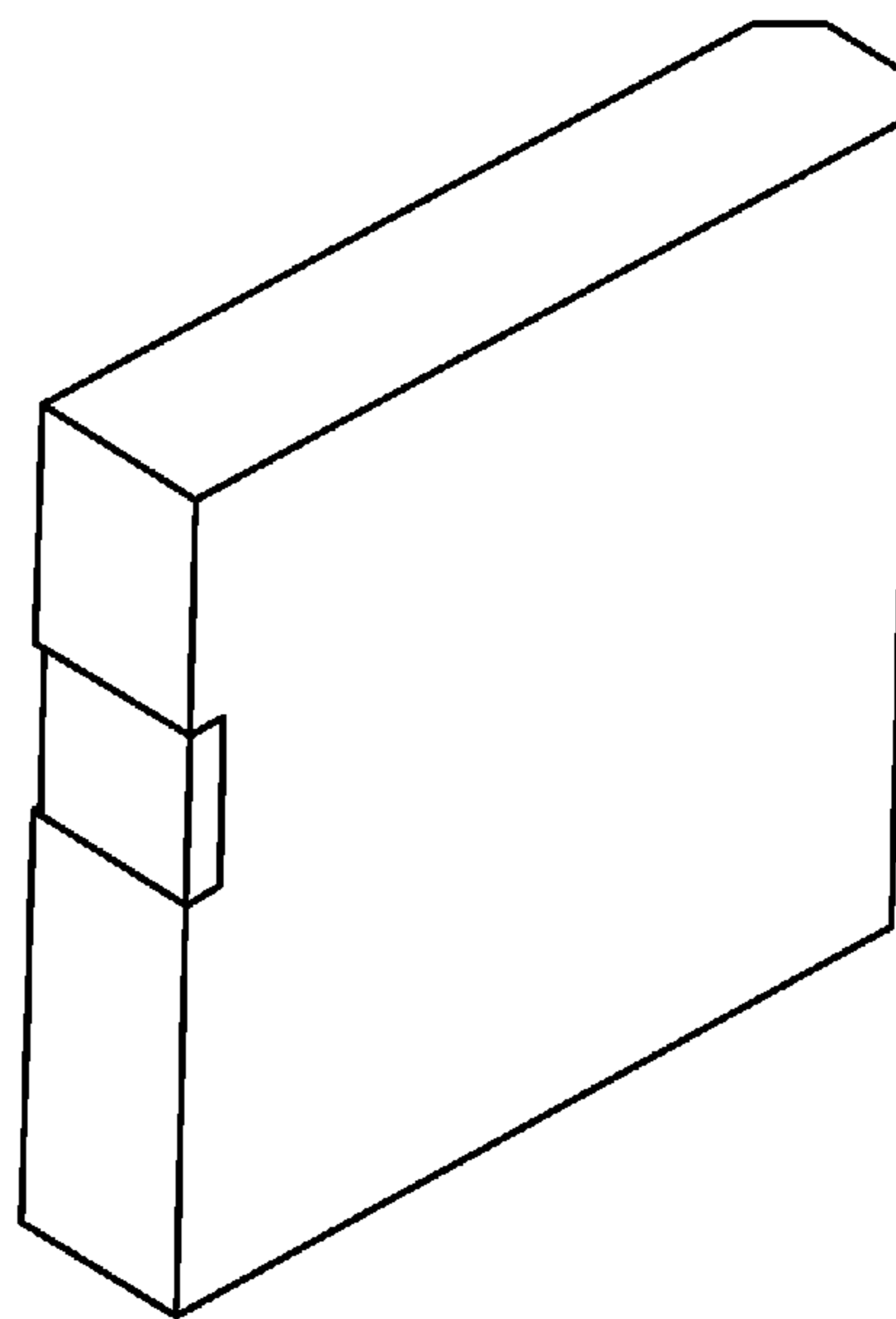

FIG. 120



FIG. 121

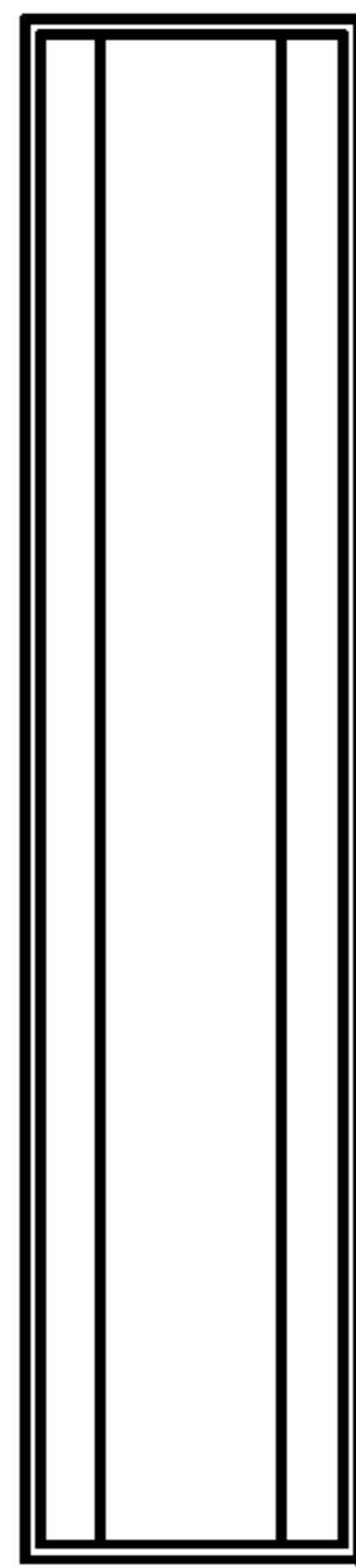

FIG. 122

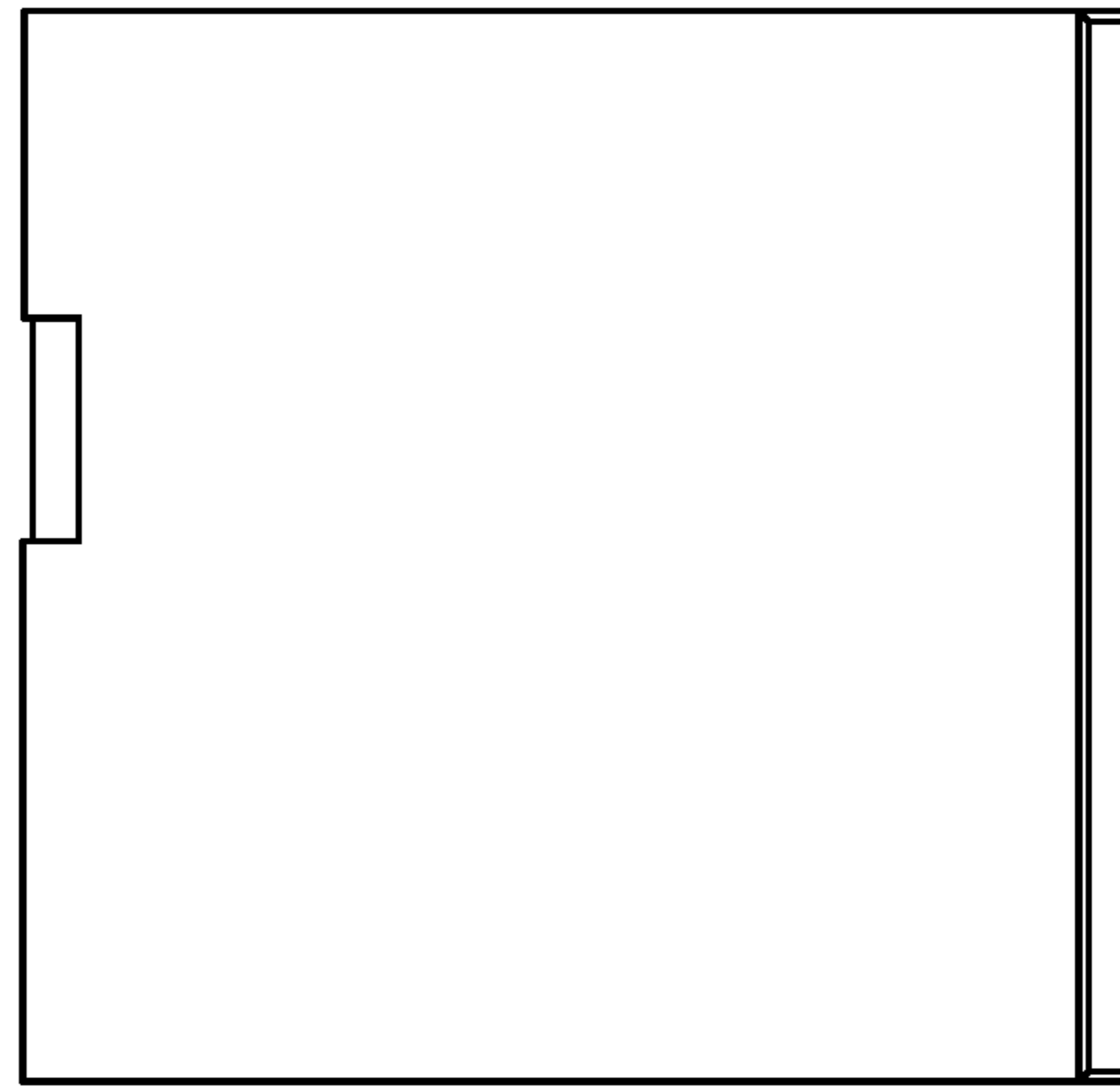

FIG. 123



FIG. 124

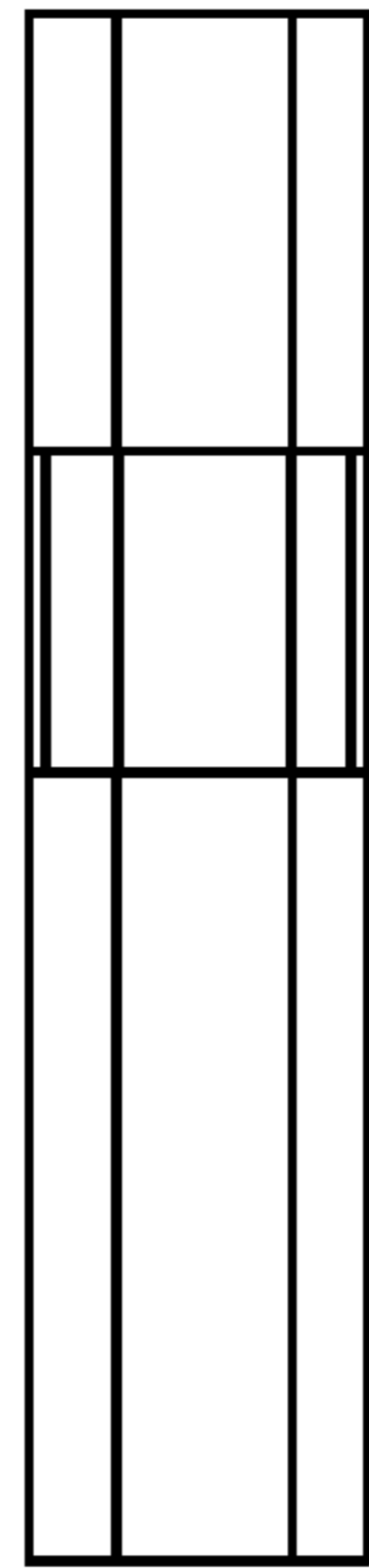

FIG. 132

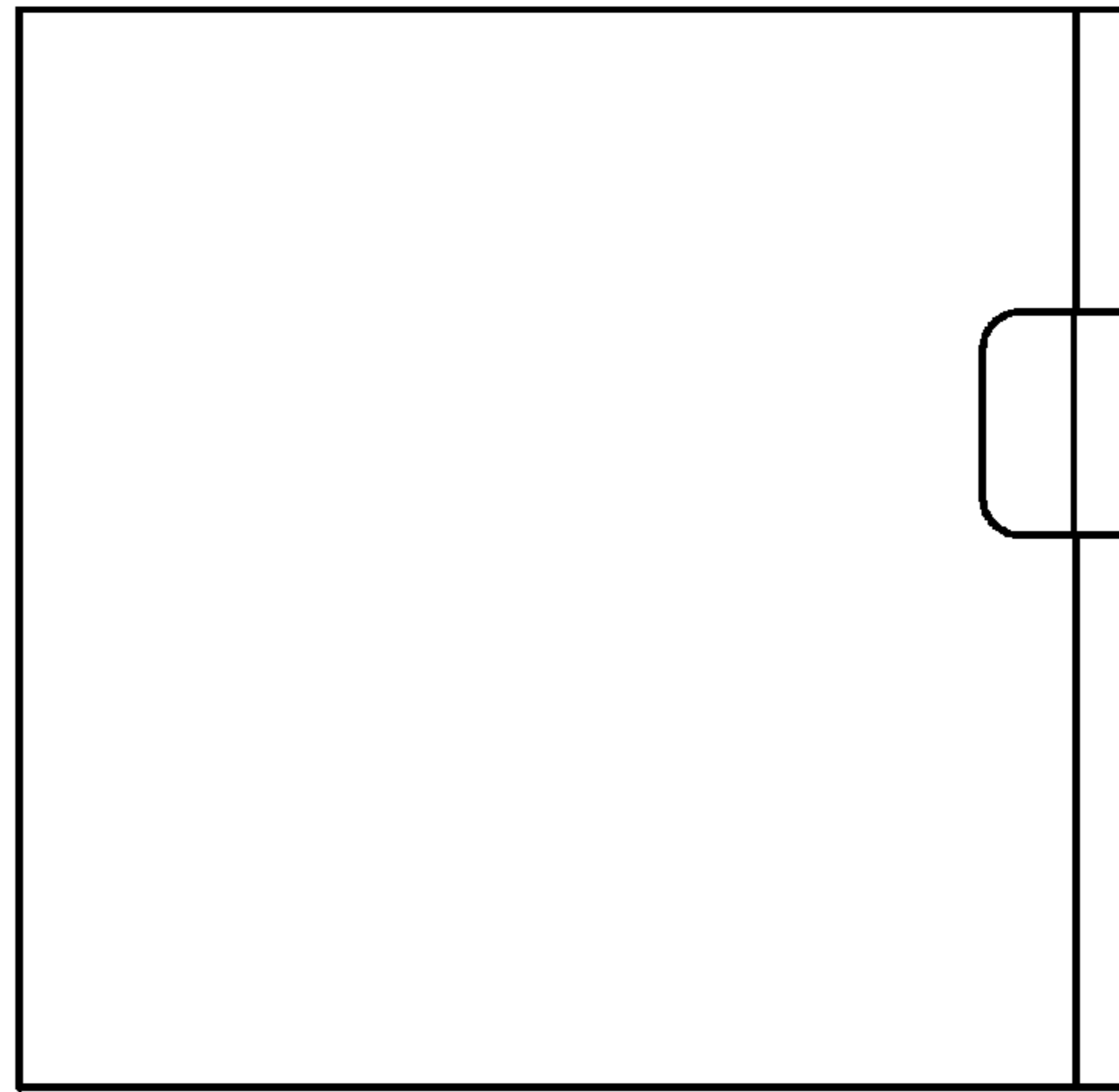

FIG. 133

FIG. 127

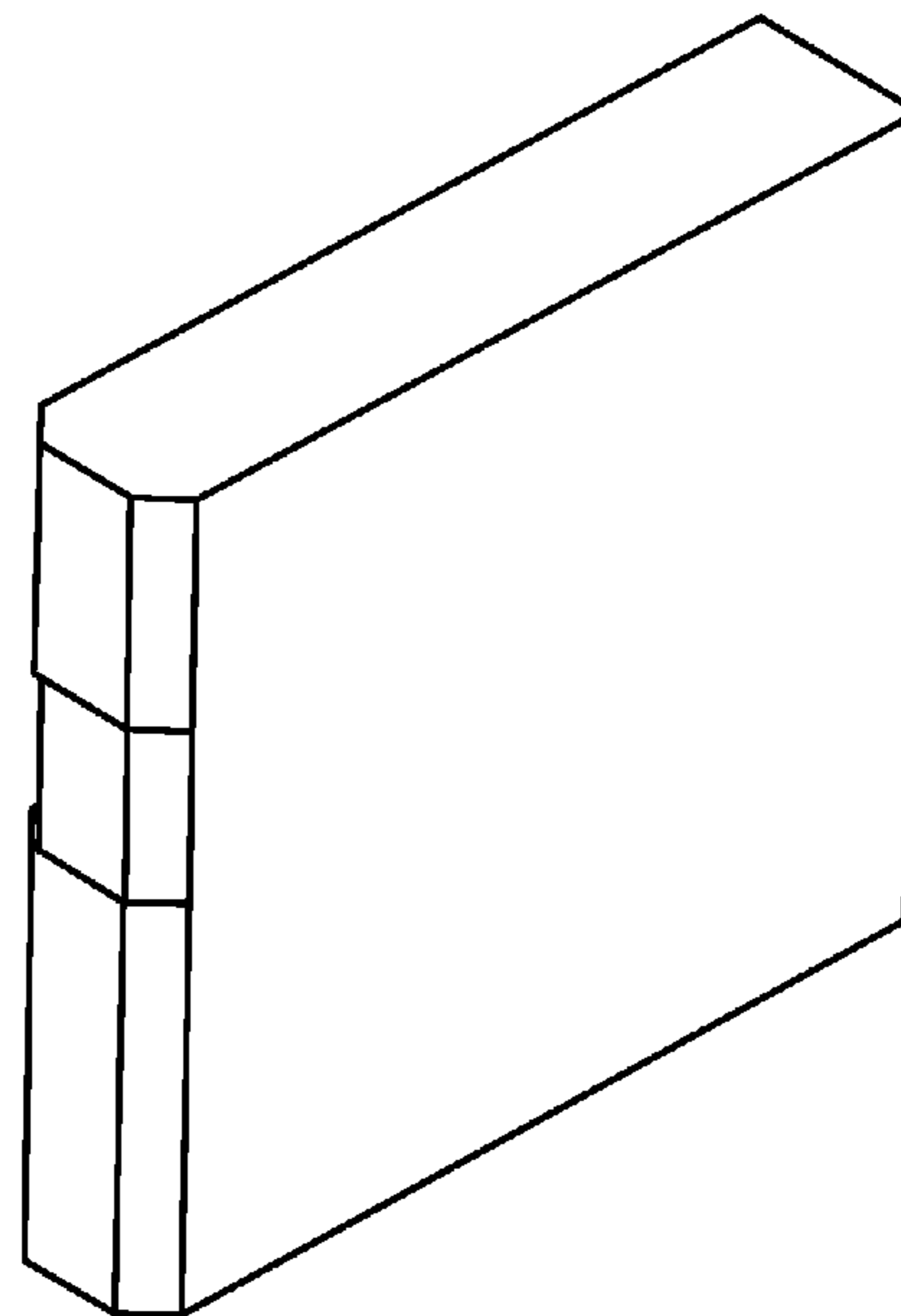





FIG. 128

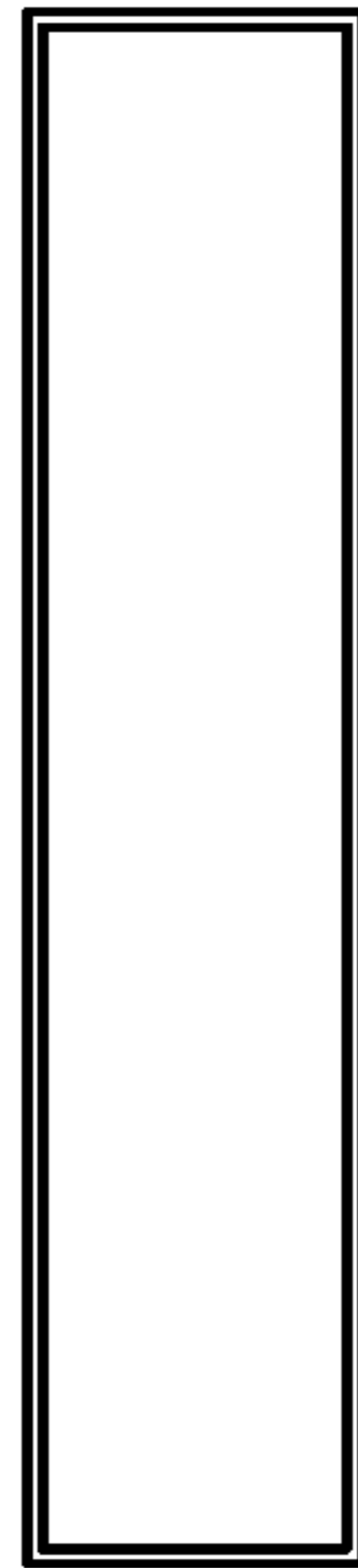

FIG. 129

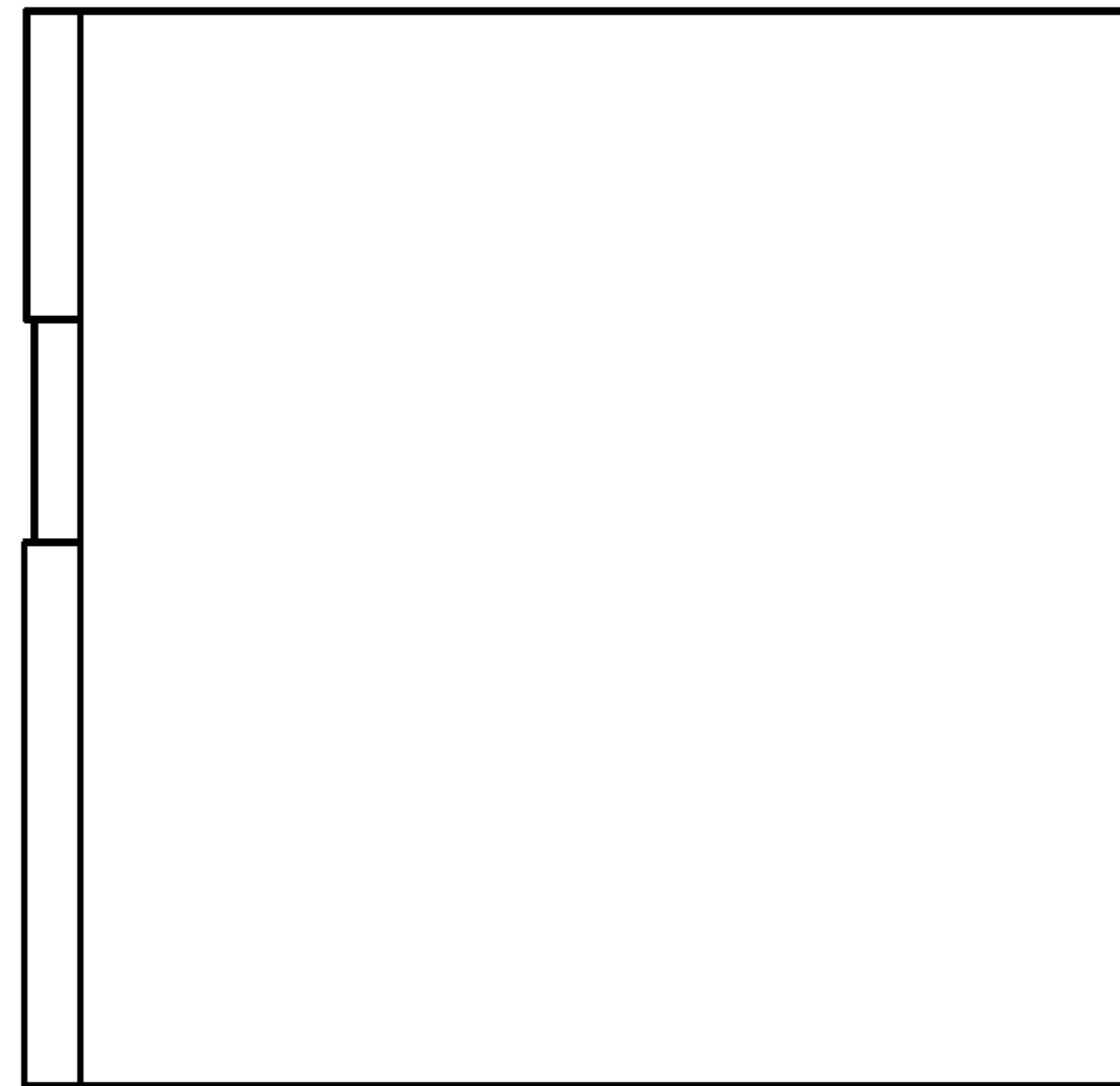

FIG. 130



FIG. 131

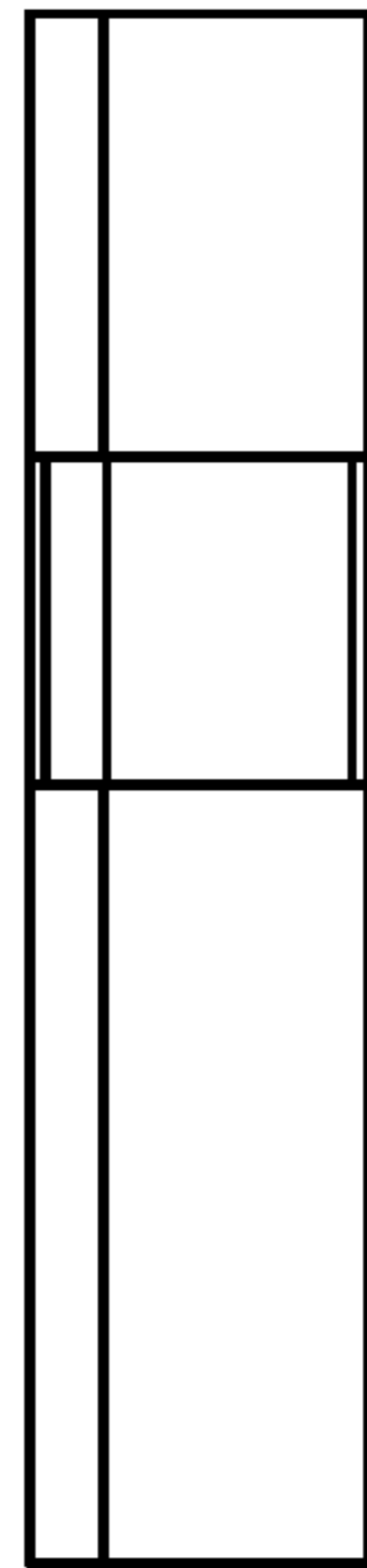

FIG. 139

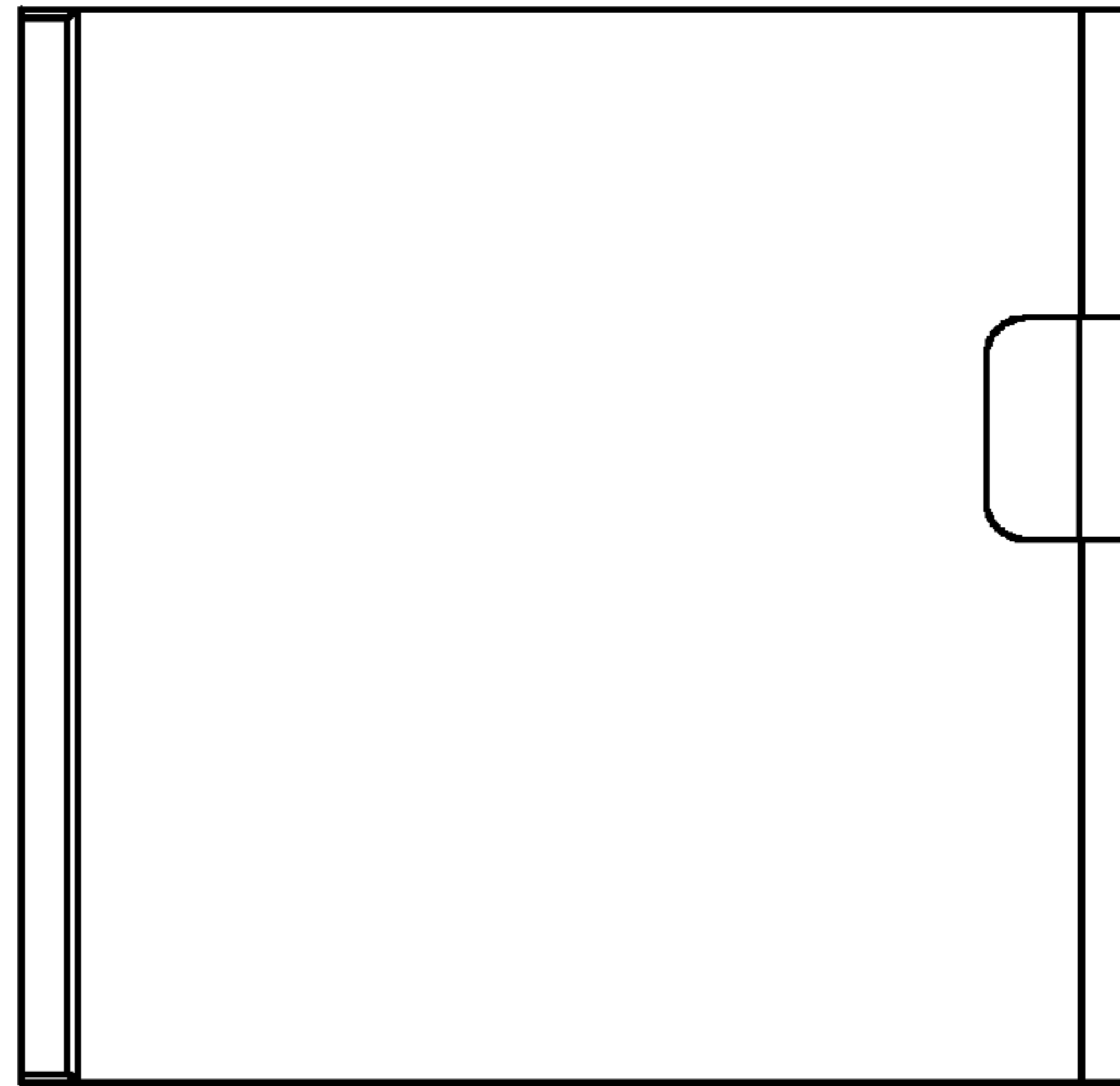

FIG. 140

FIG. 134

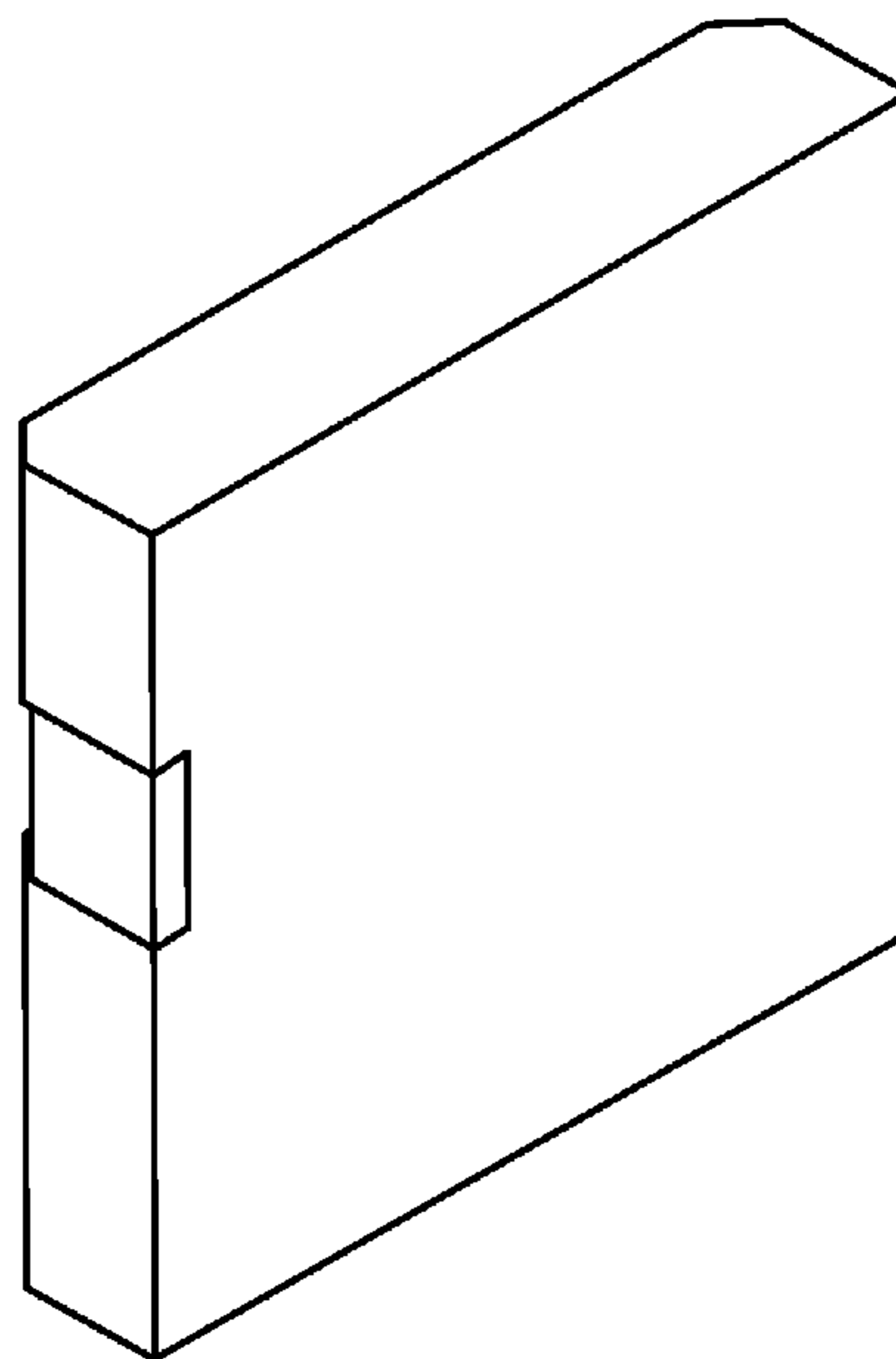



FIG. 135

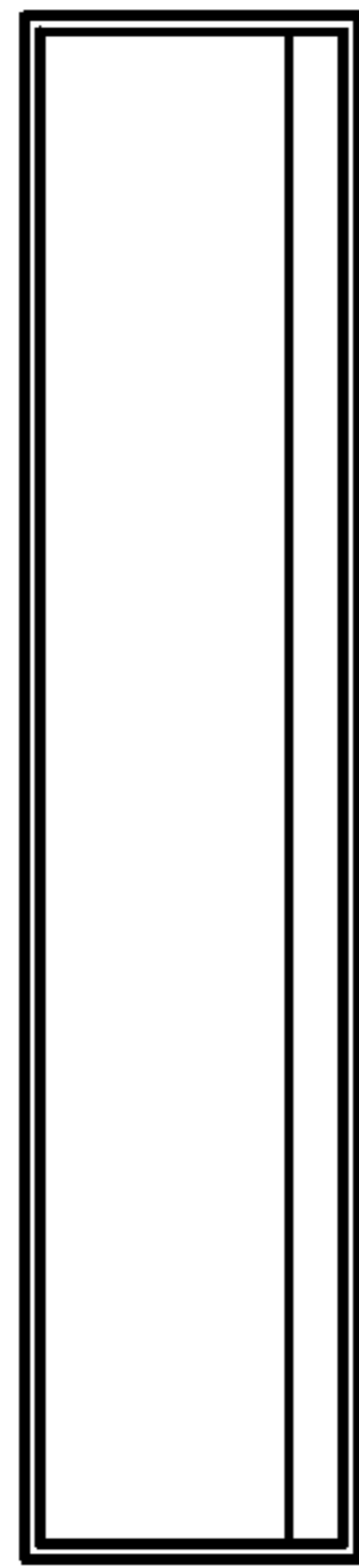

FIG. 136

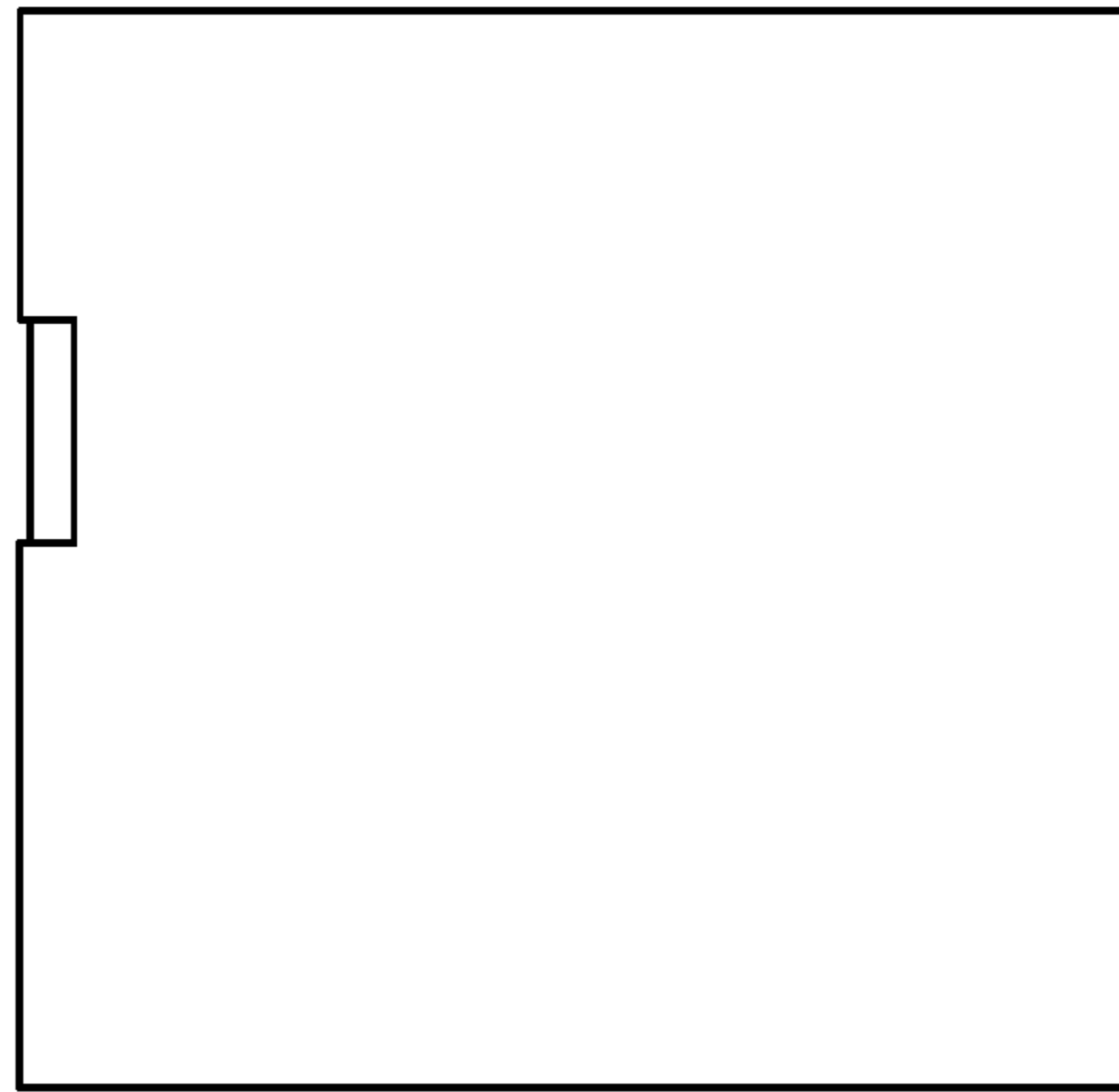

FIG. 137



FIG. 138

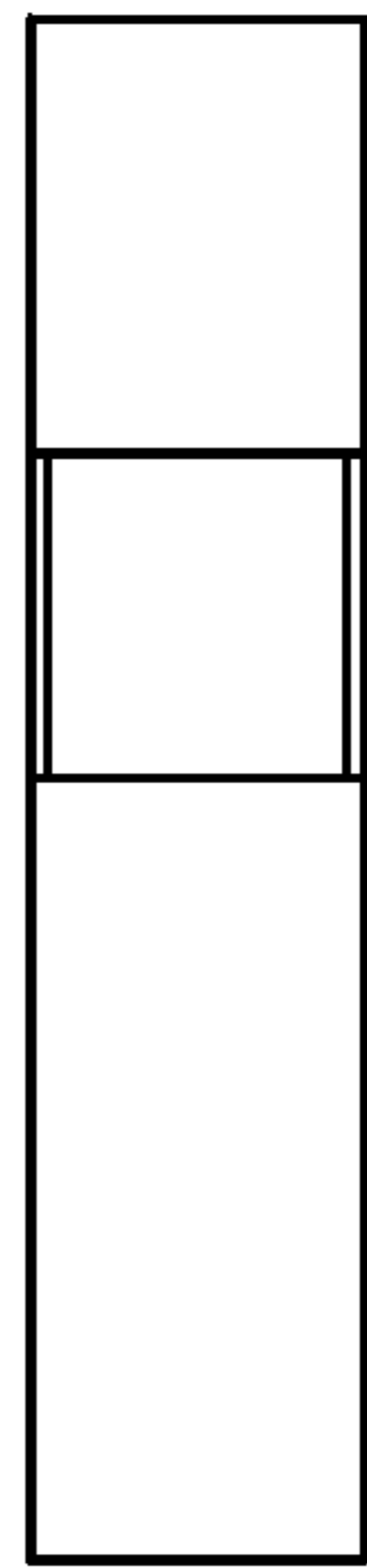

FIG. 146

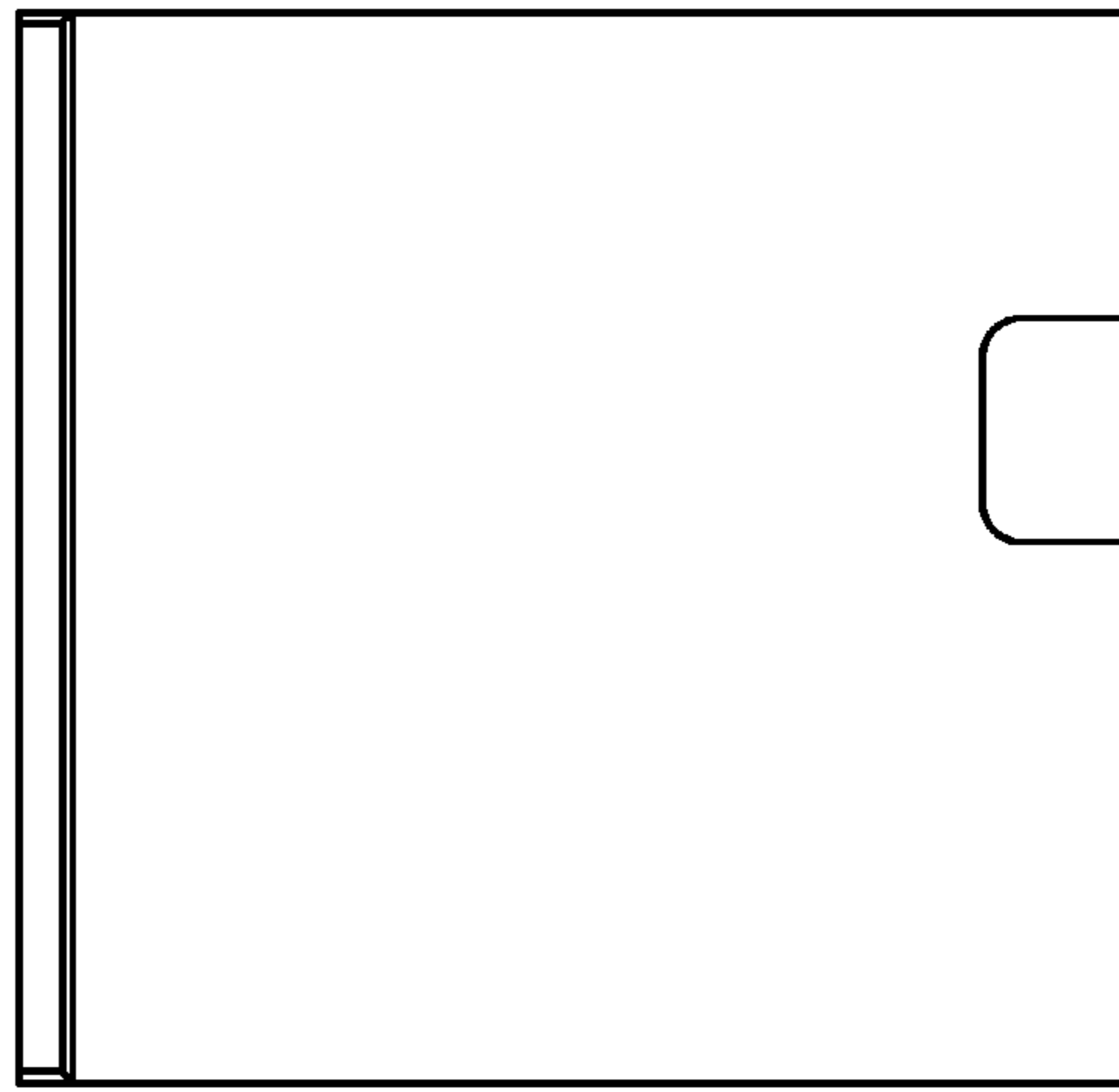

FIG. 147

FIG. 141

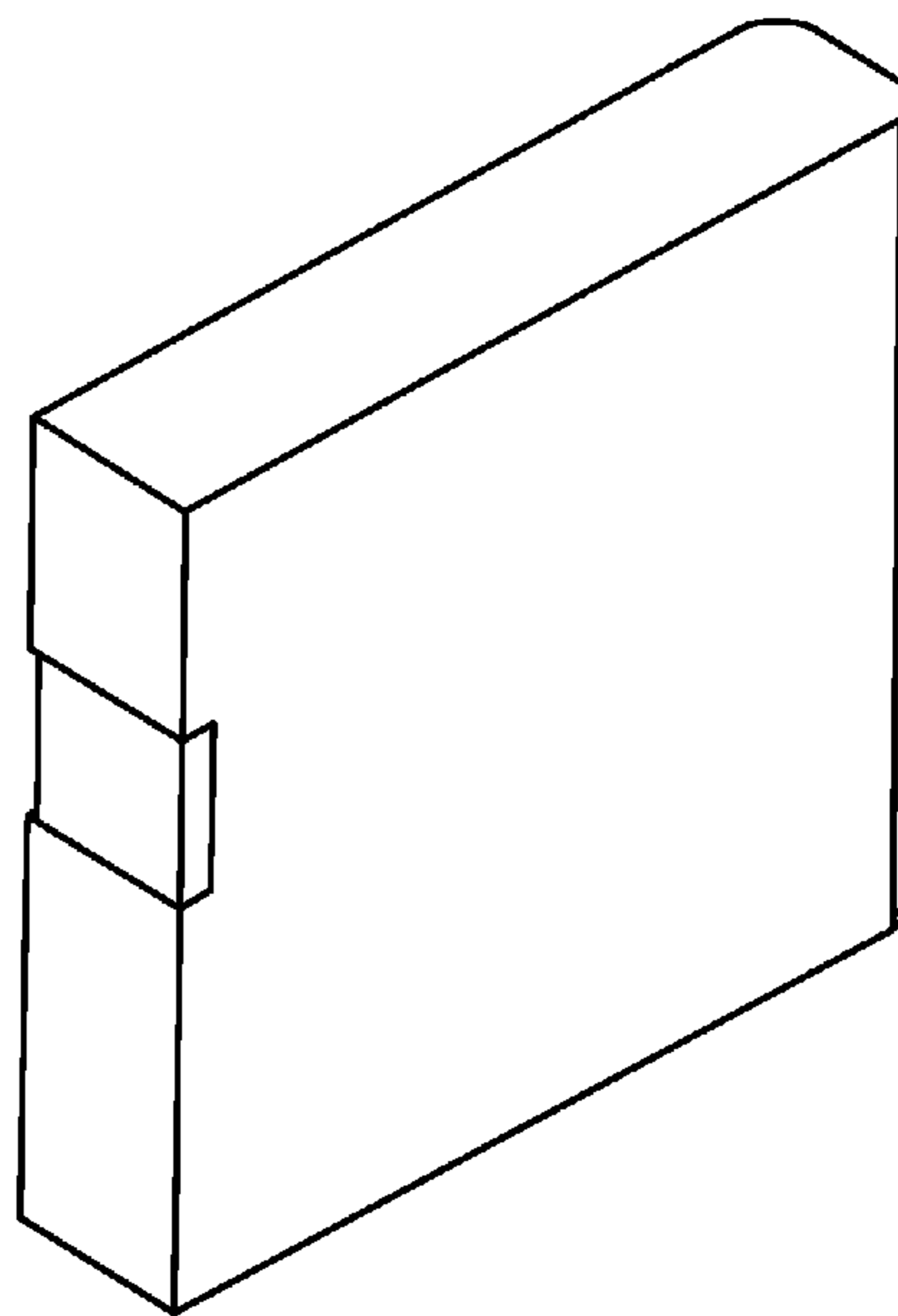



FIG. 142

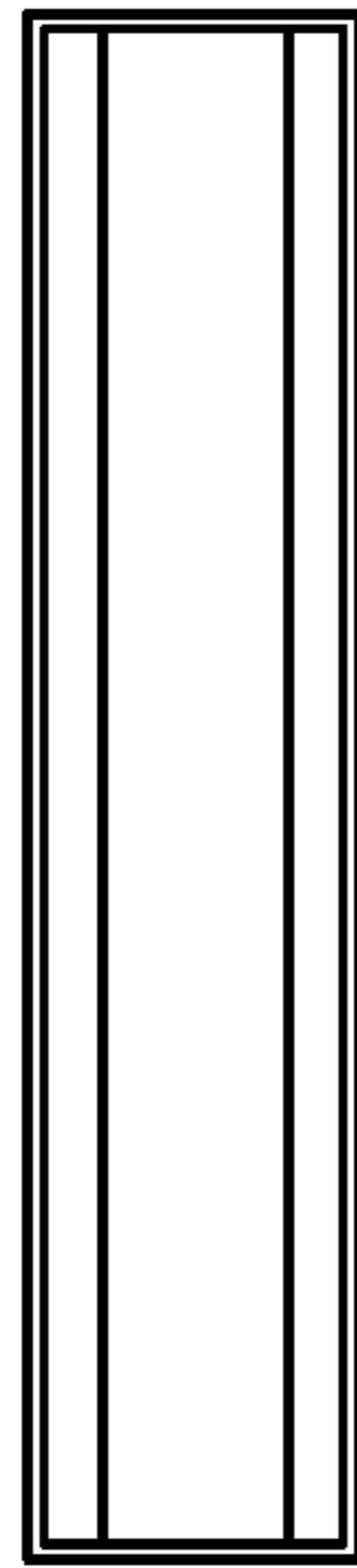

FIG. 143

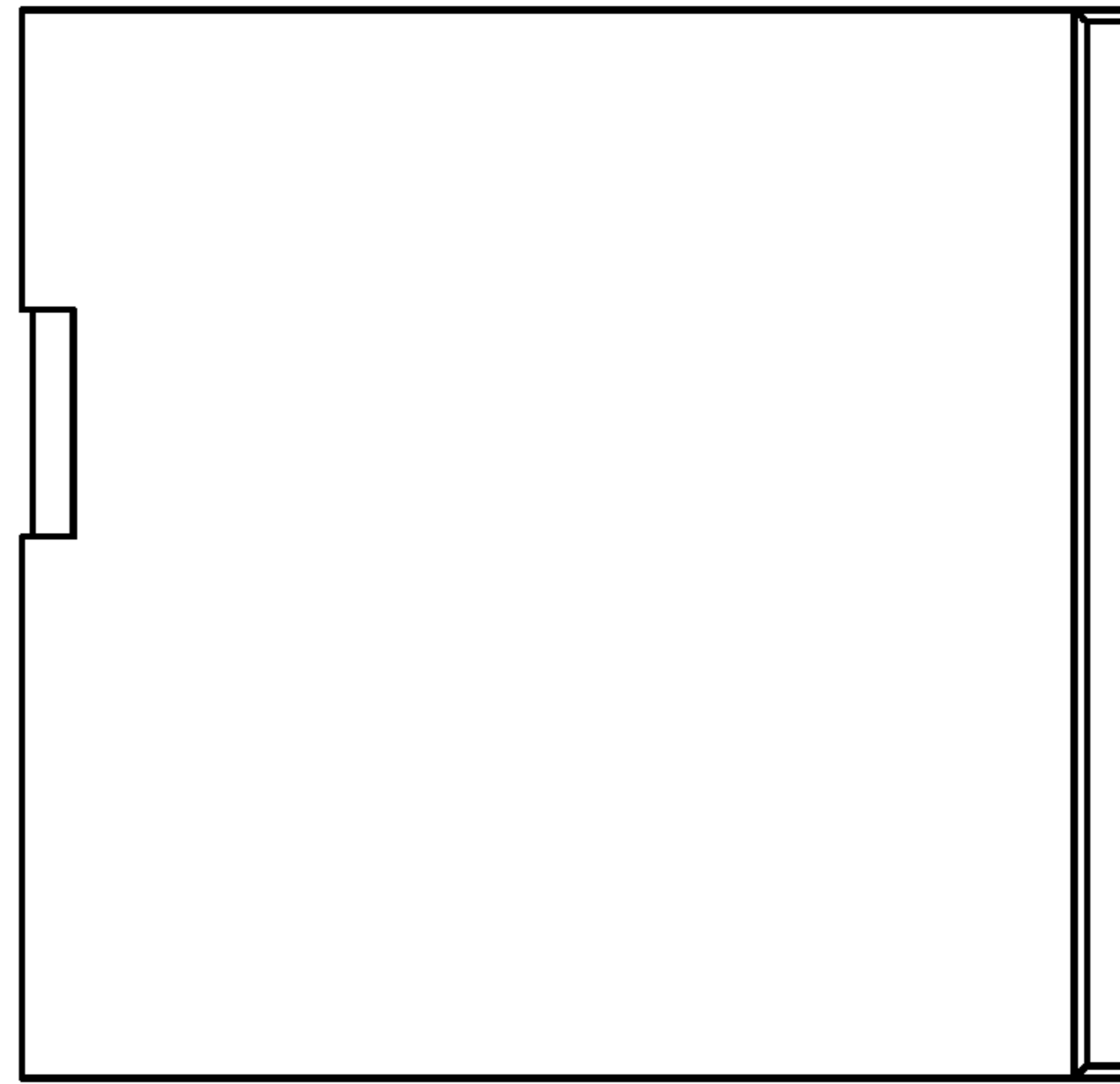

FIG. 144



FIG. 145

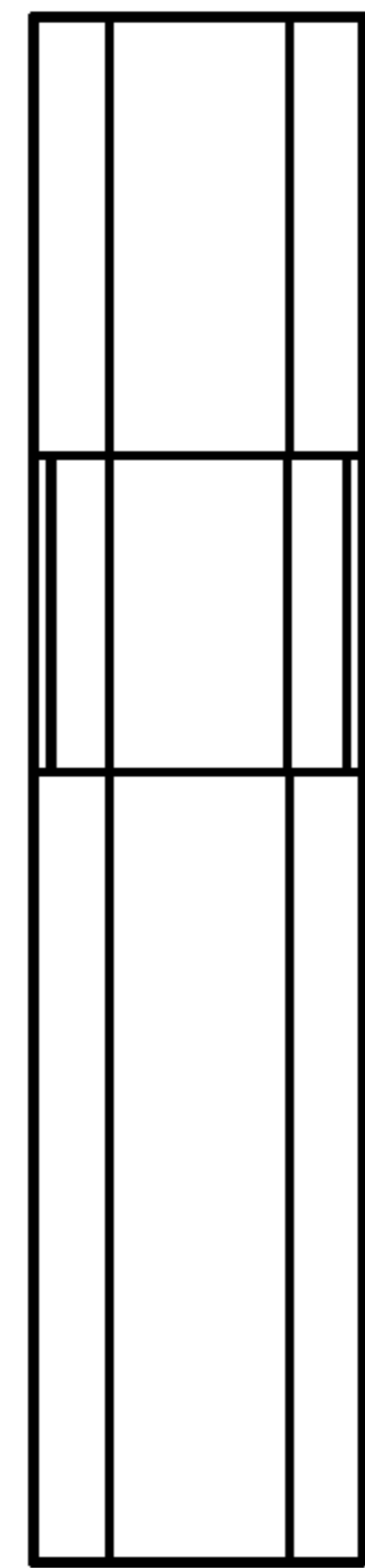

FIG. 153

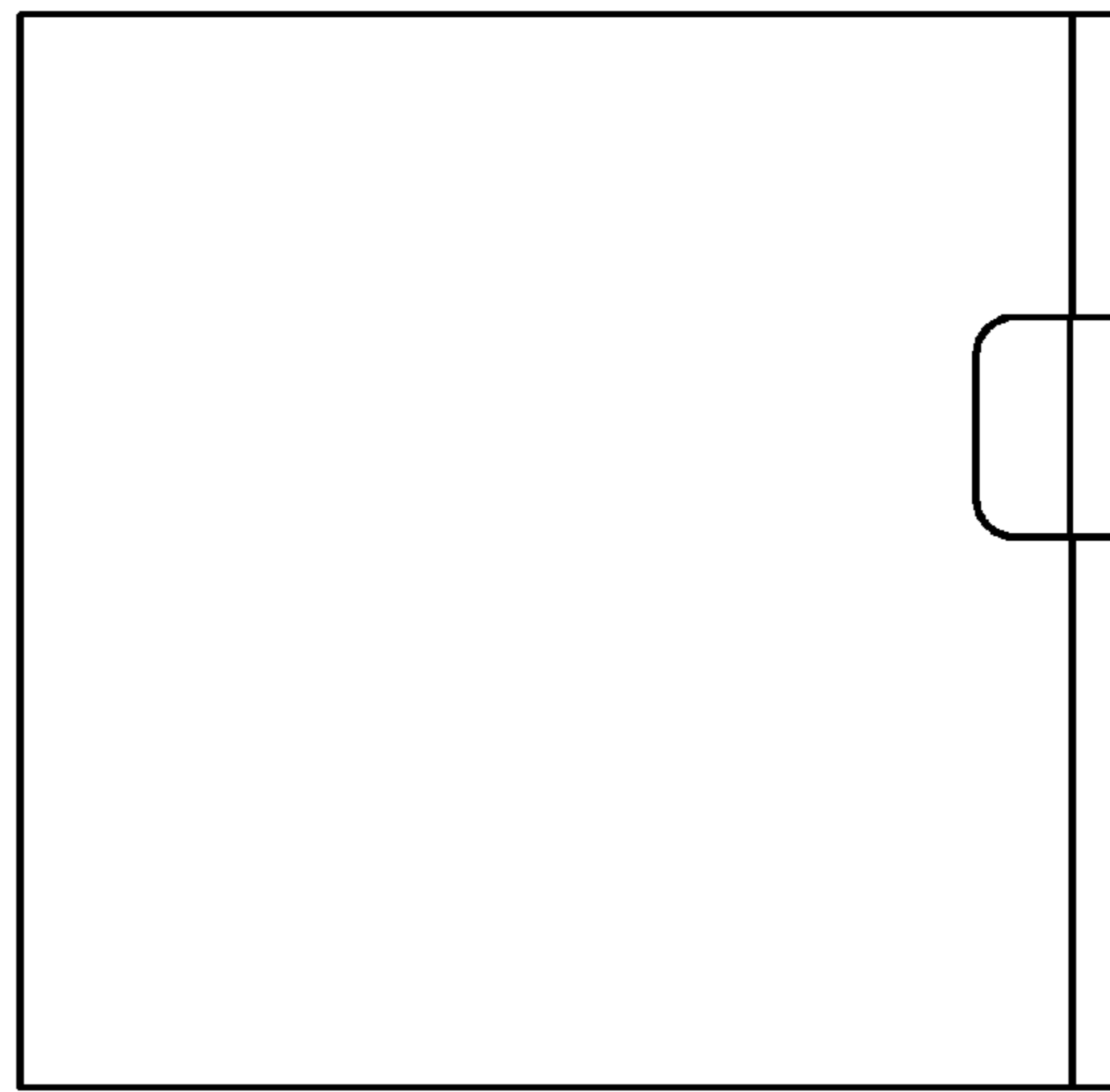

FIG. 154

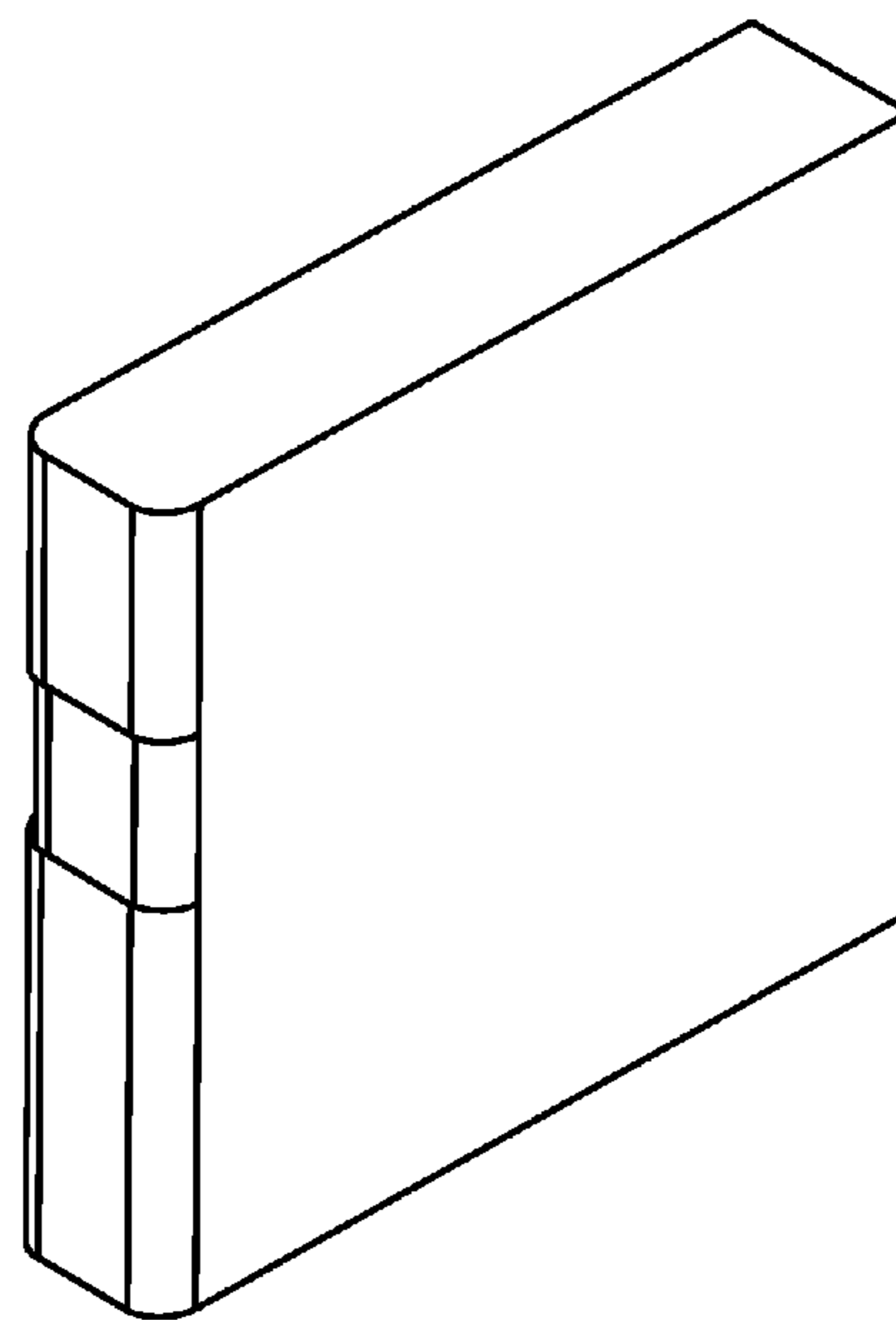

FIG. 148



FIG. 149

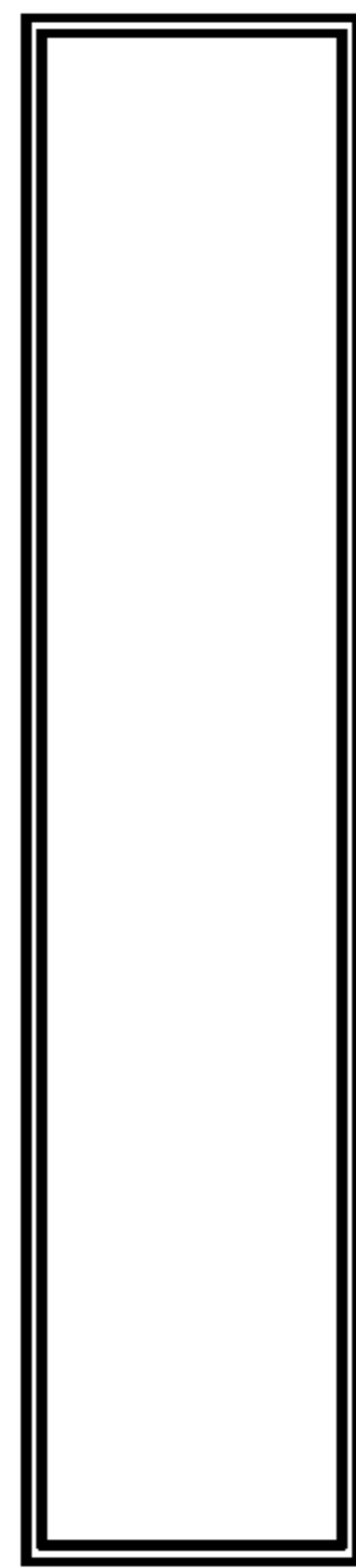

FIG. 150

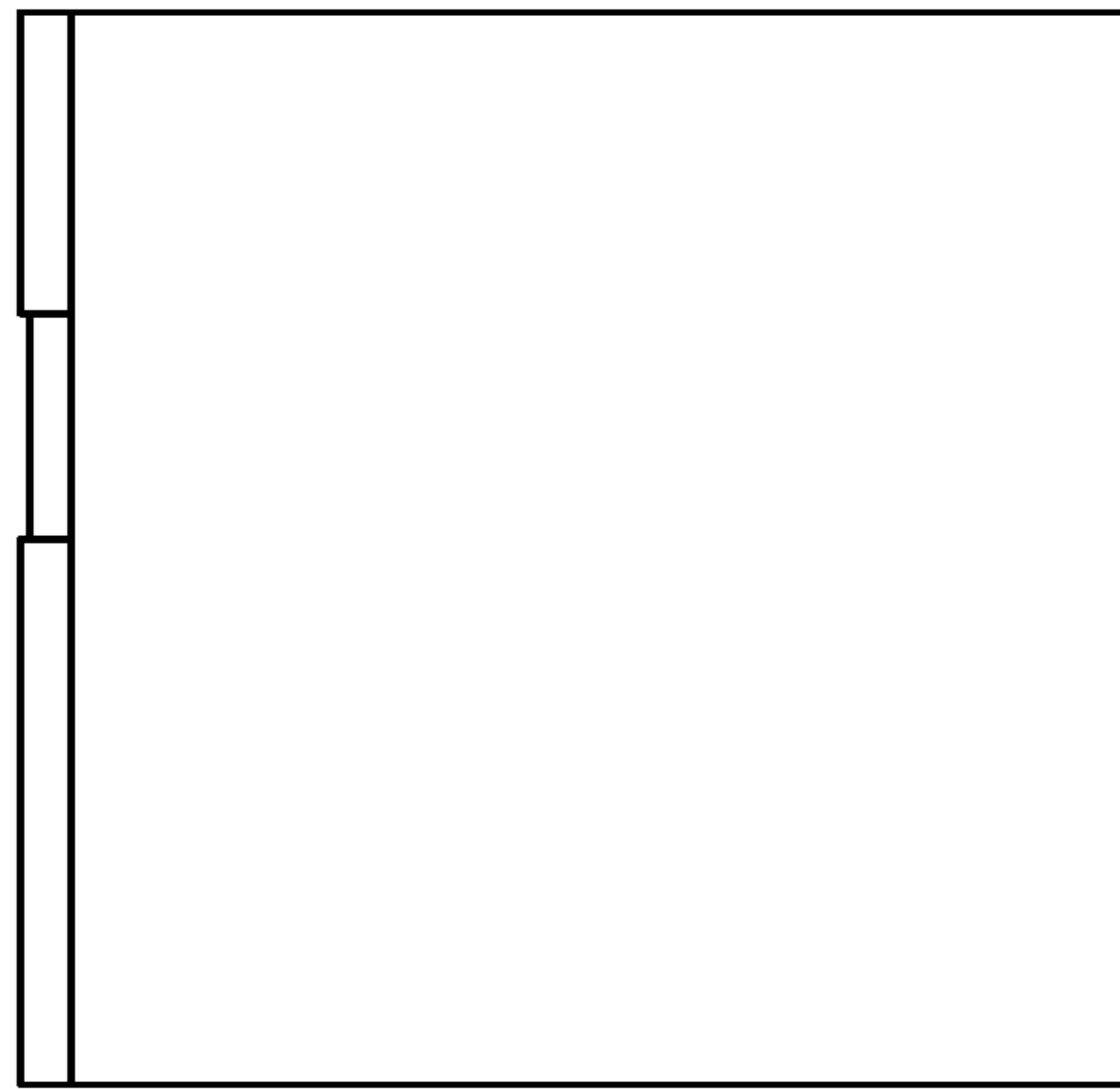

FIG. 151



FIG. 152

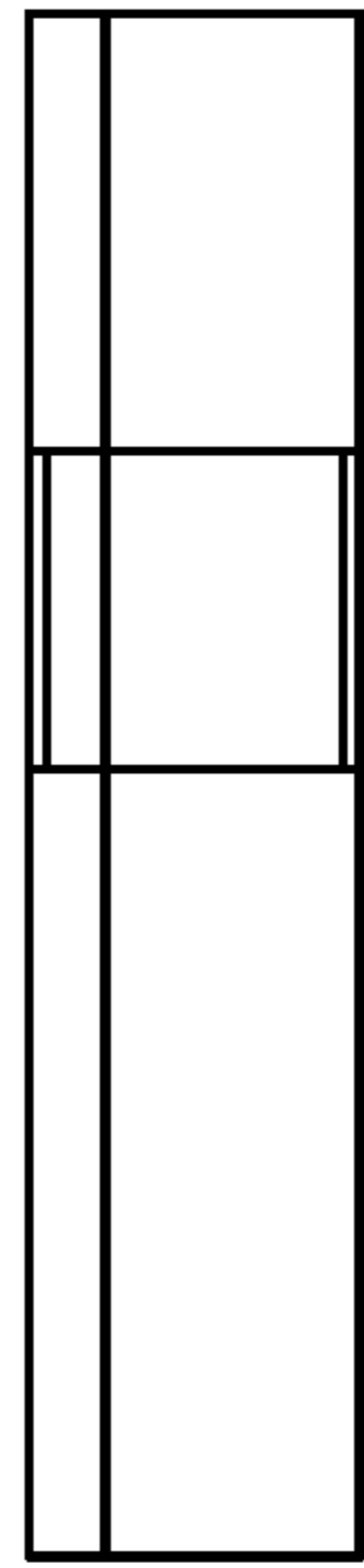

FIG. 160

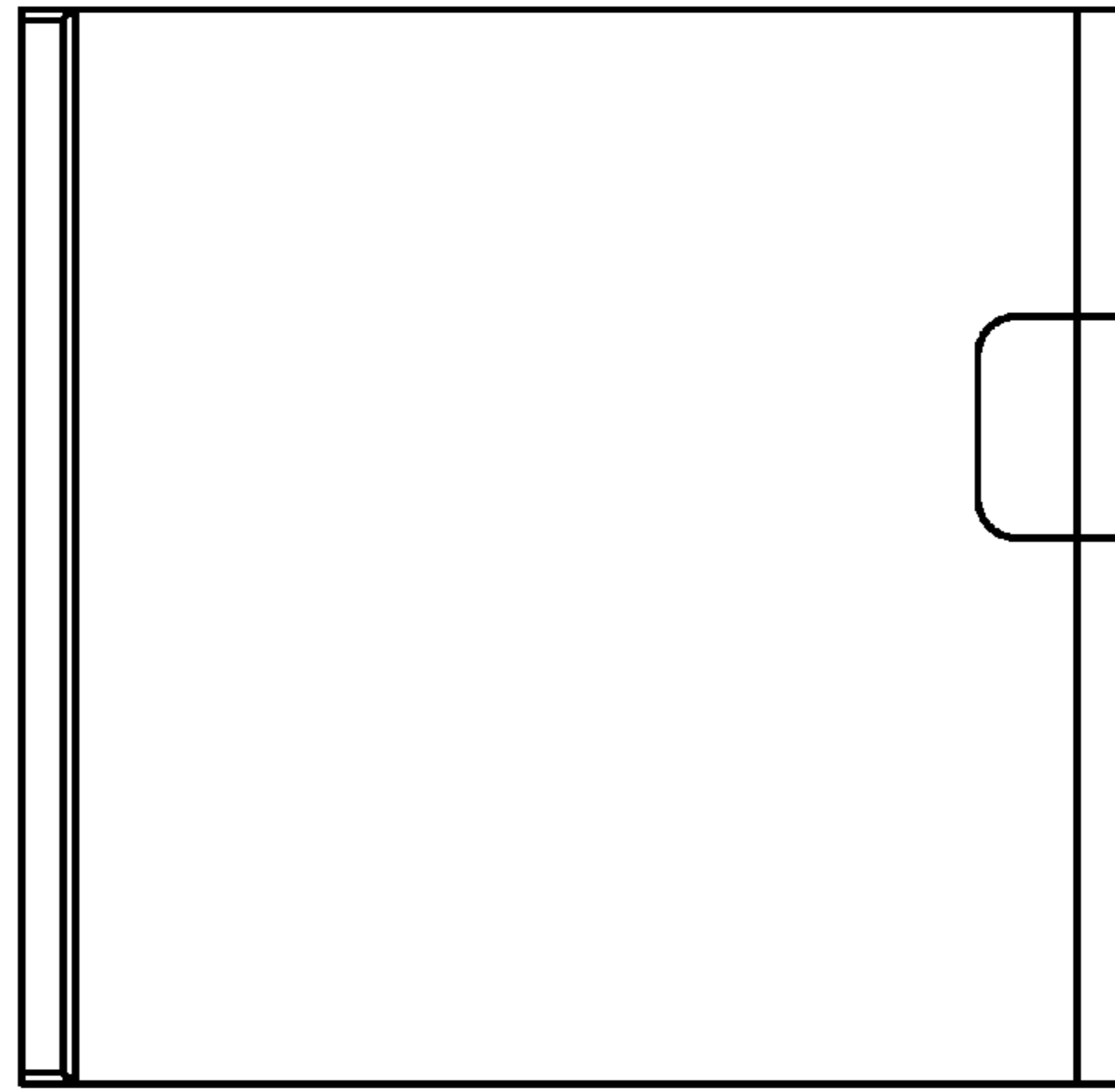

FIG. 161

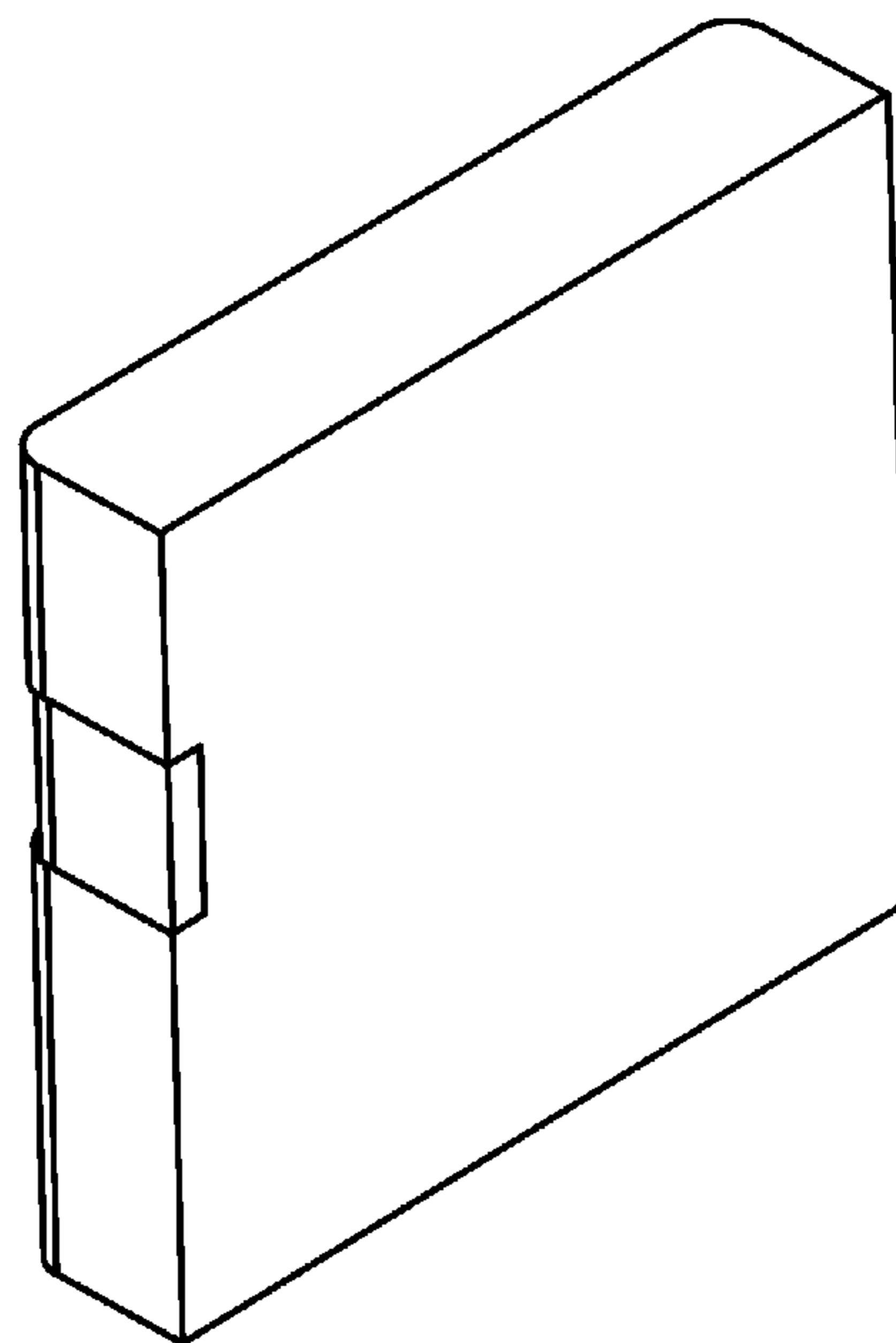

FIG. 155





FIG. 156

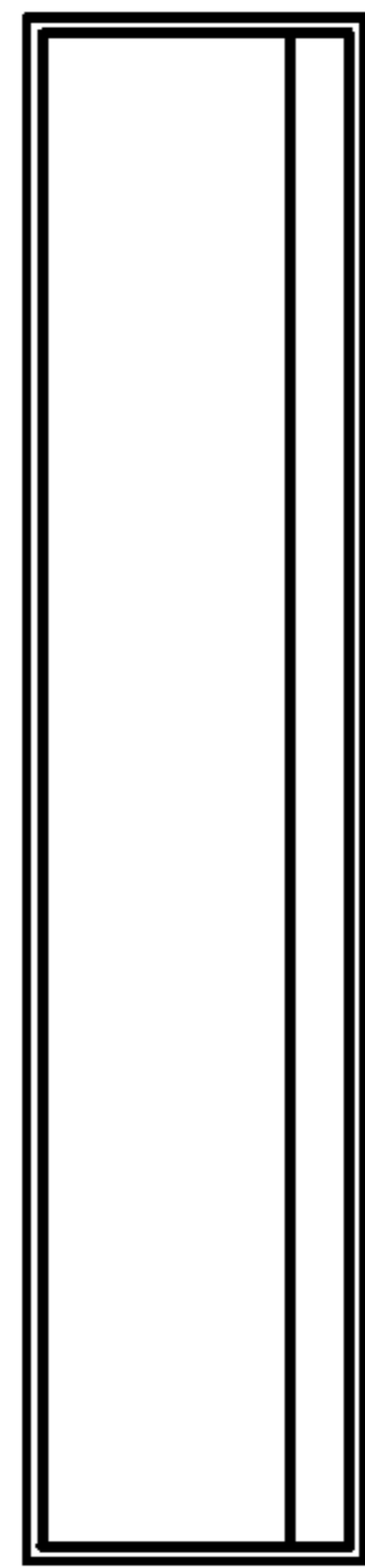

FIG. 157

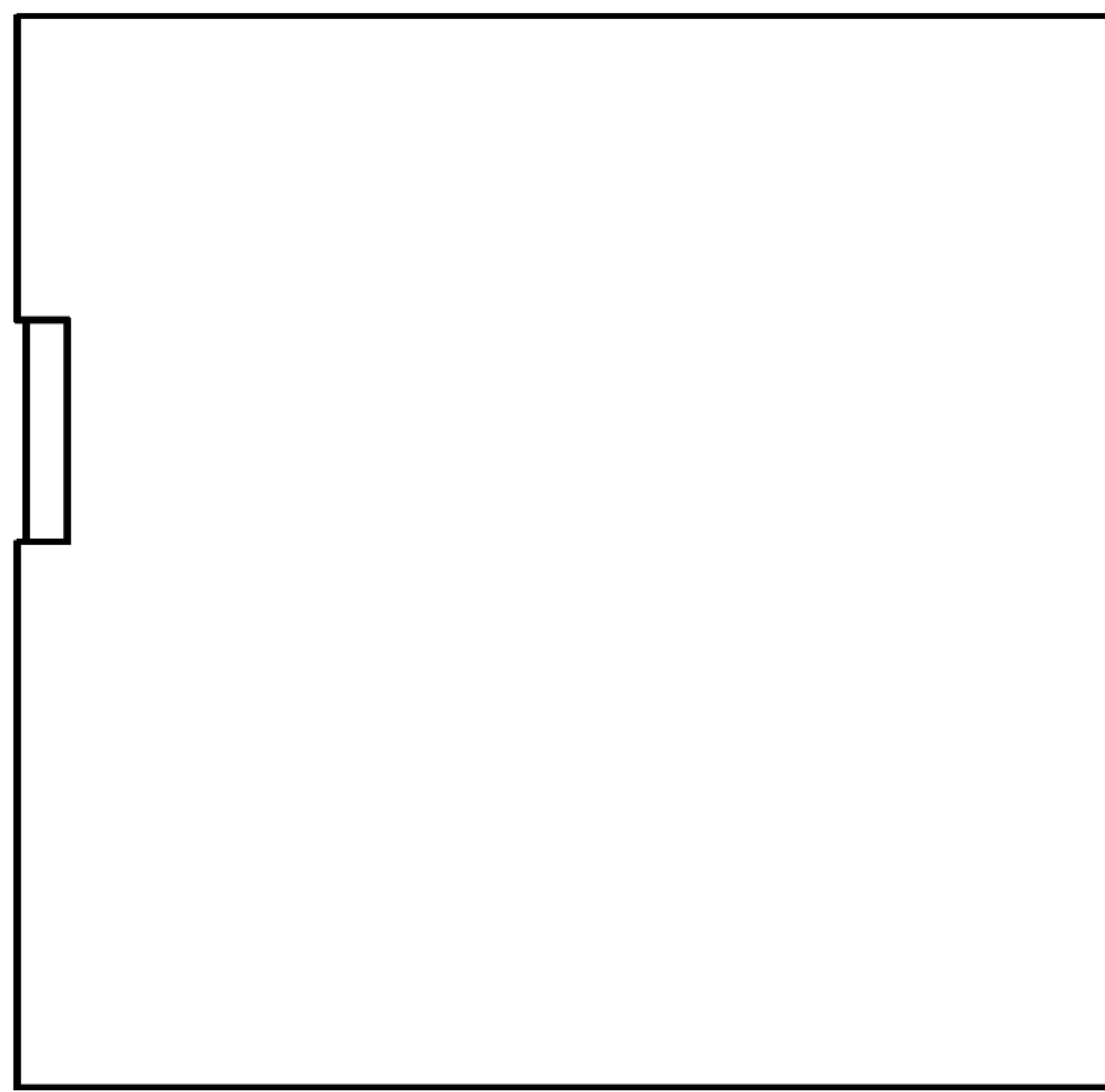

FIG. 158



FIG. 159

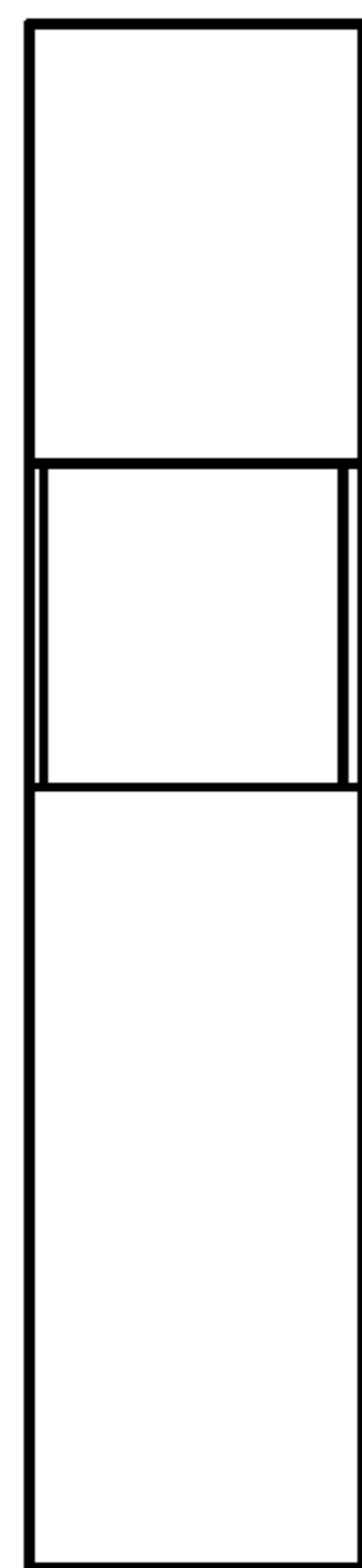

FIG. 167

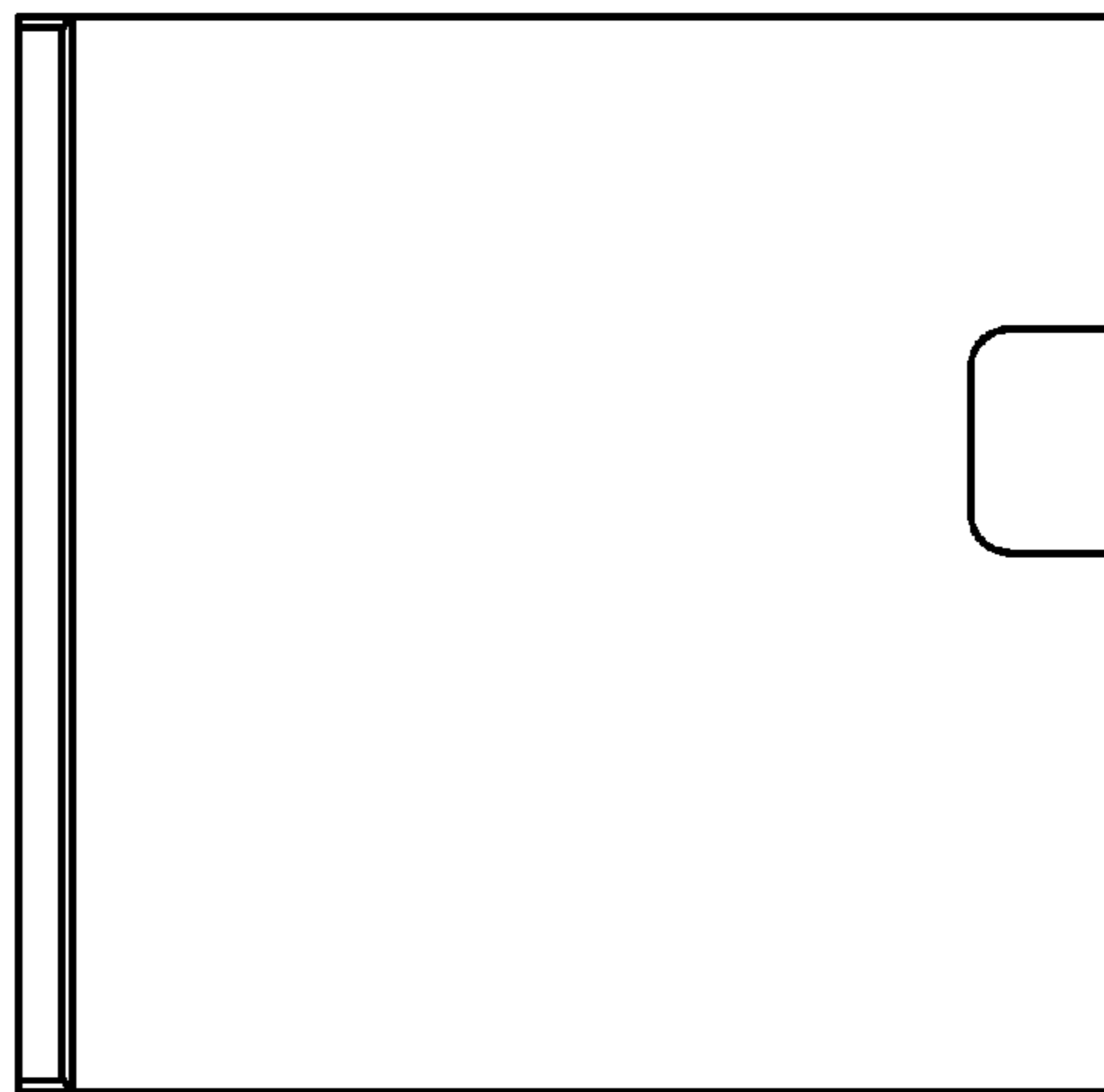

FIG. 168

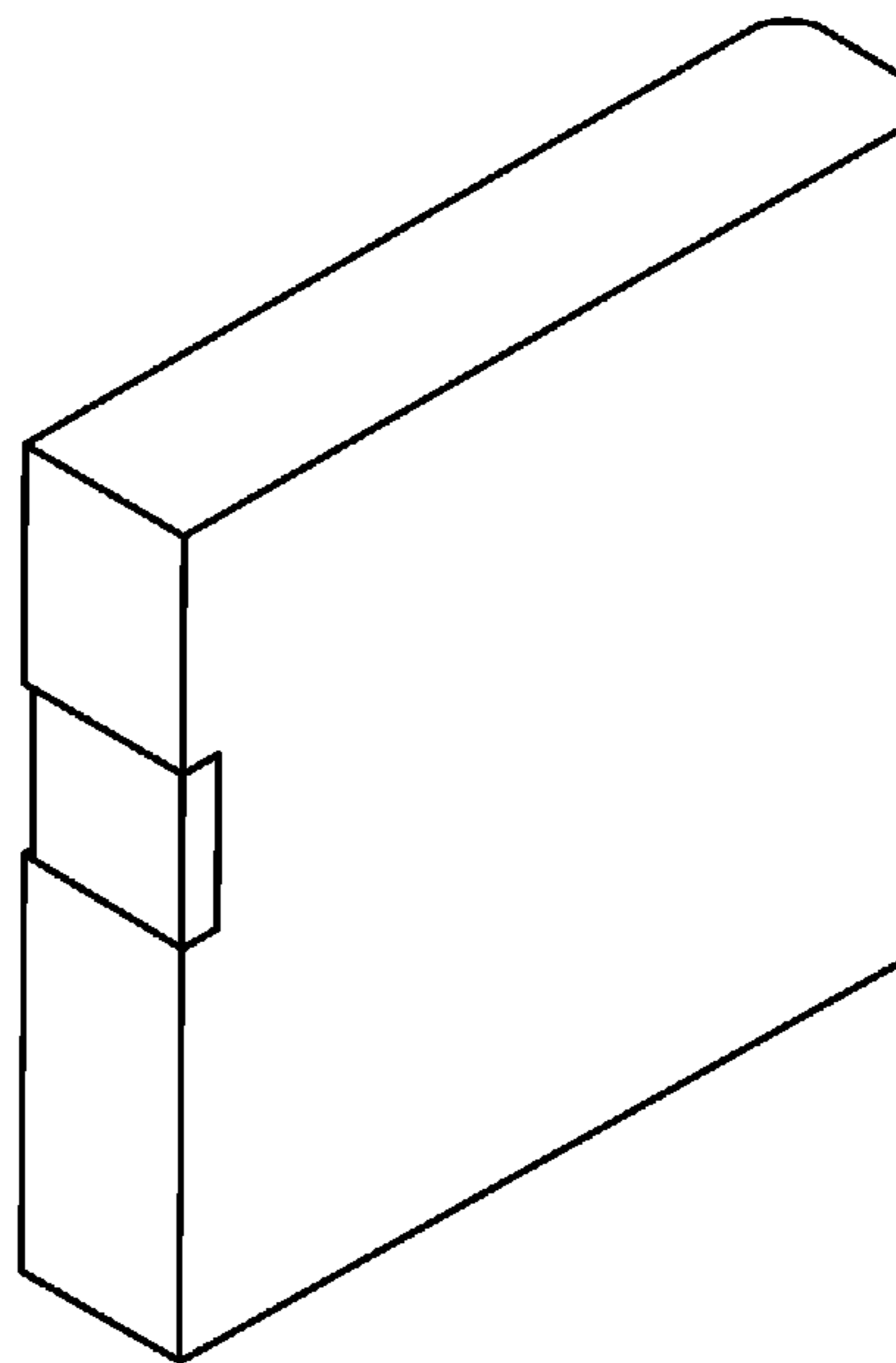

FIG. 162



FIG. 163

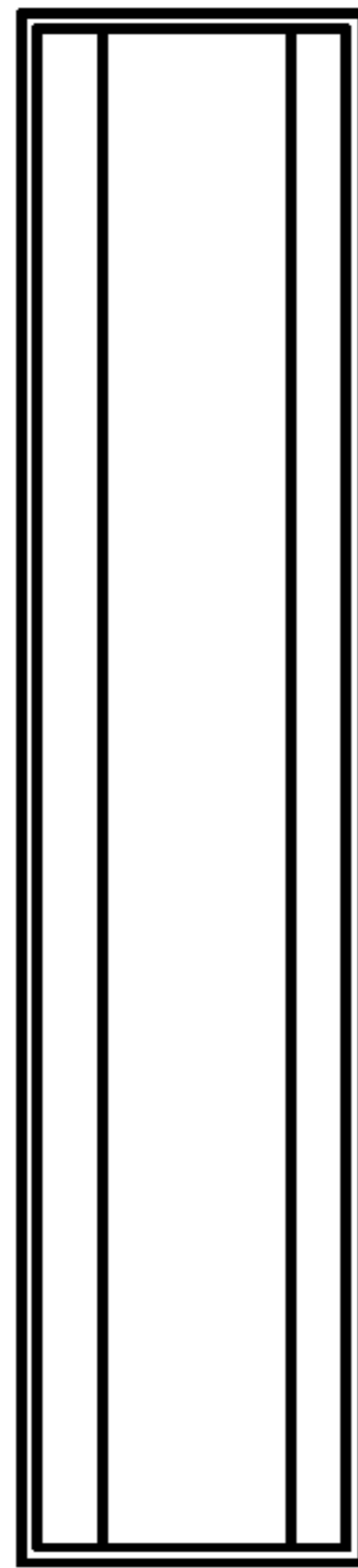

FIG. 164

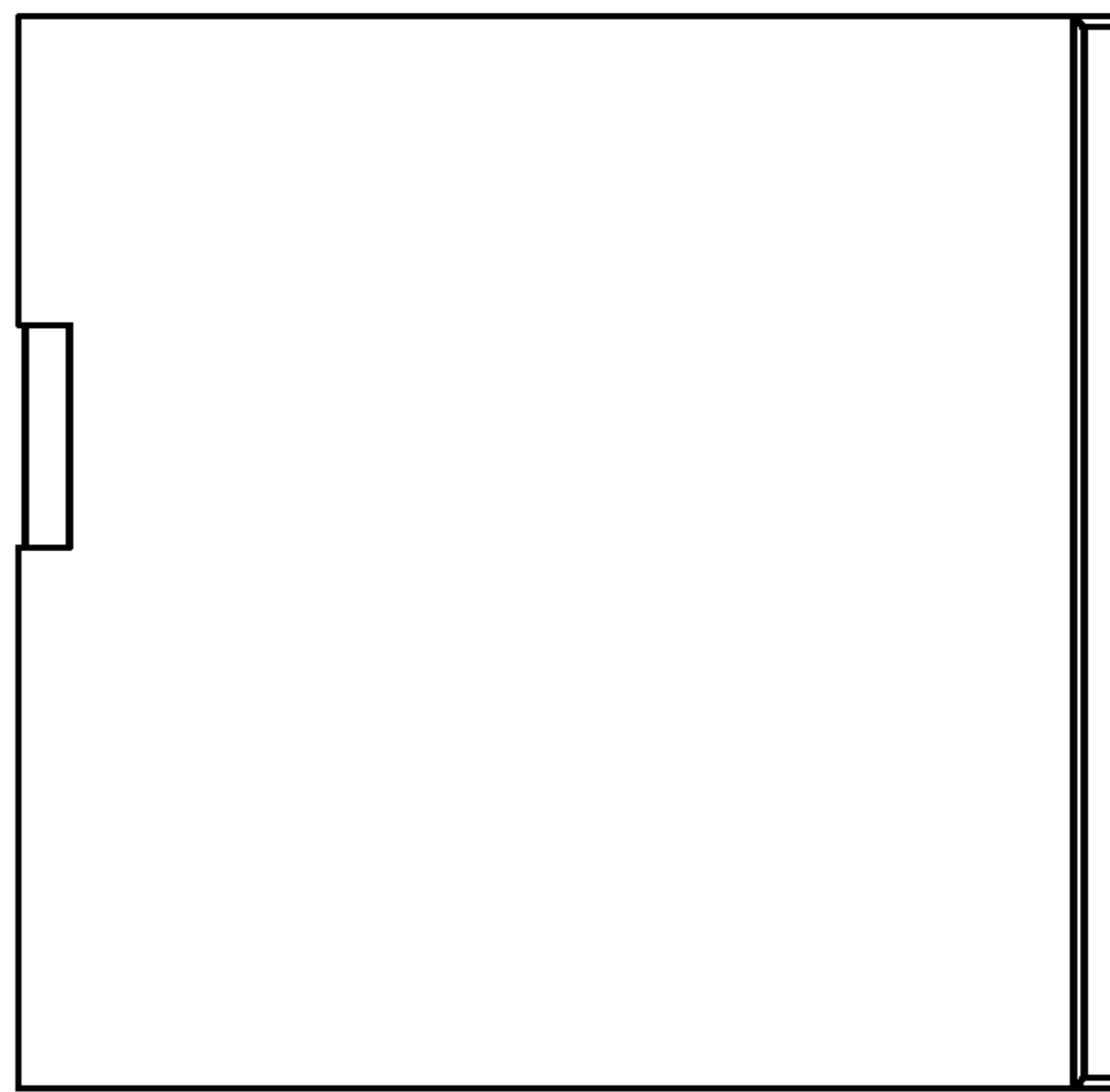

FIG. 165



FIG. 166

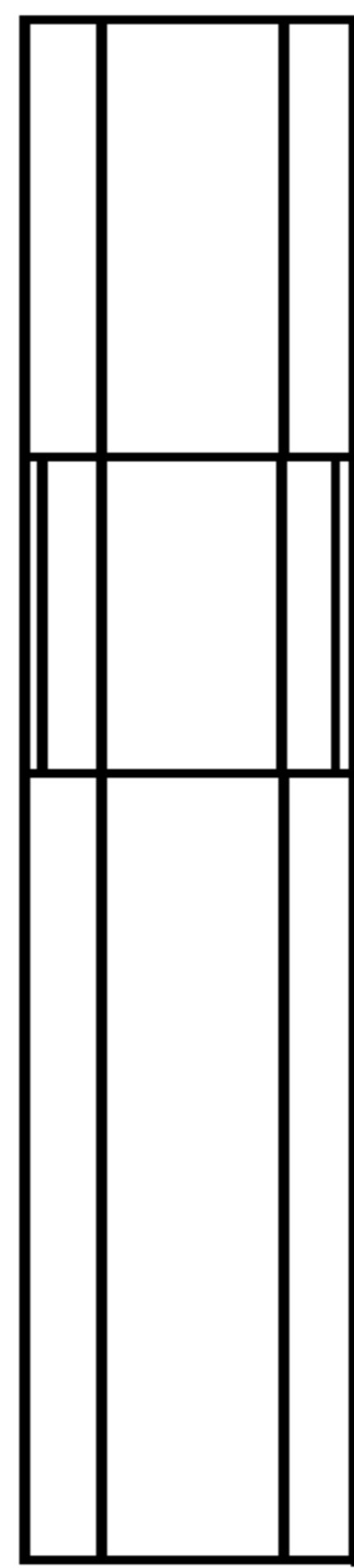

FIG. 174

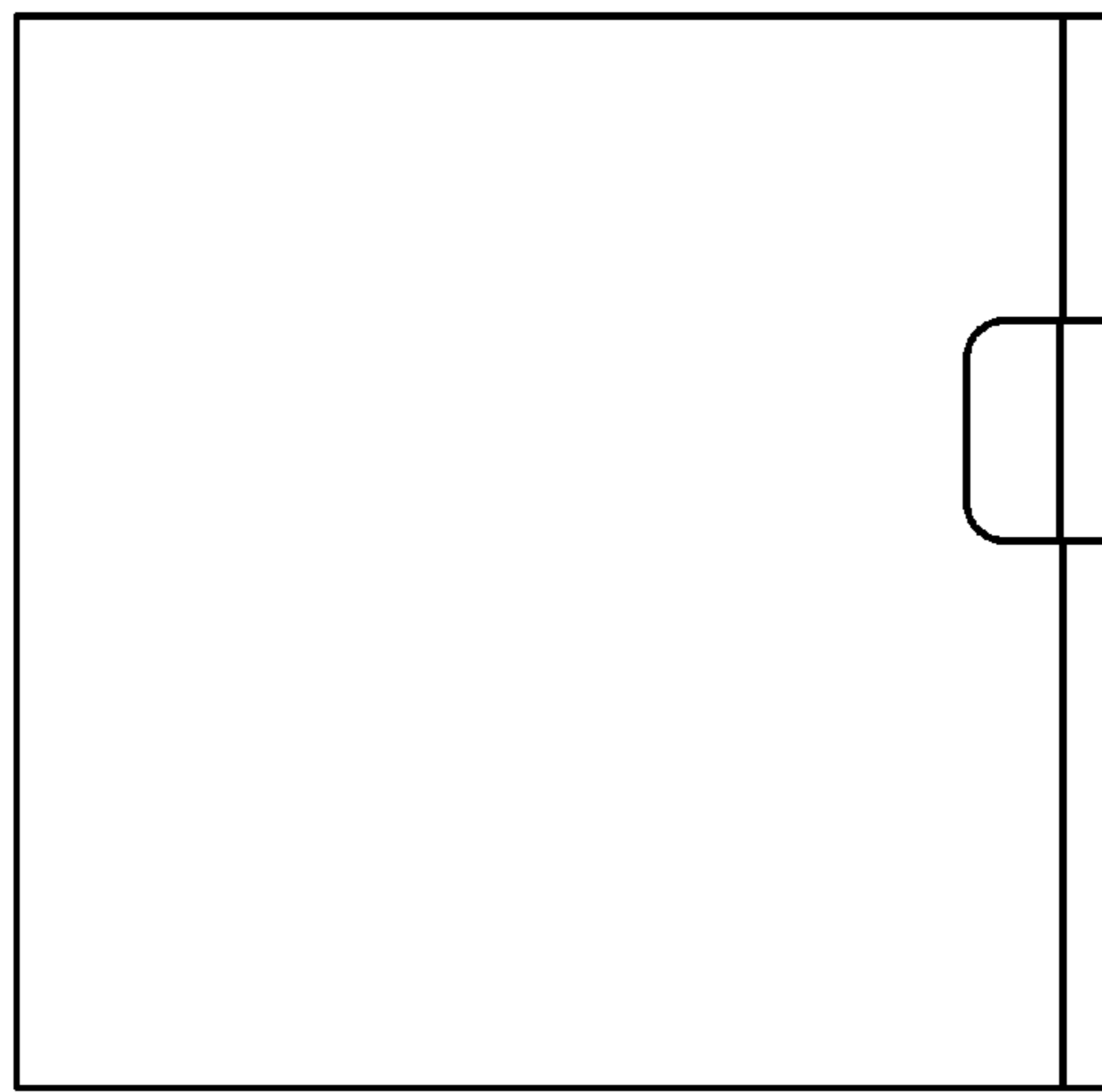

FIG. 175

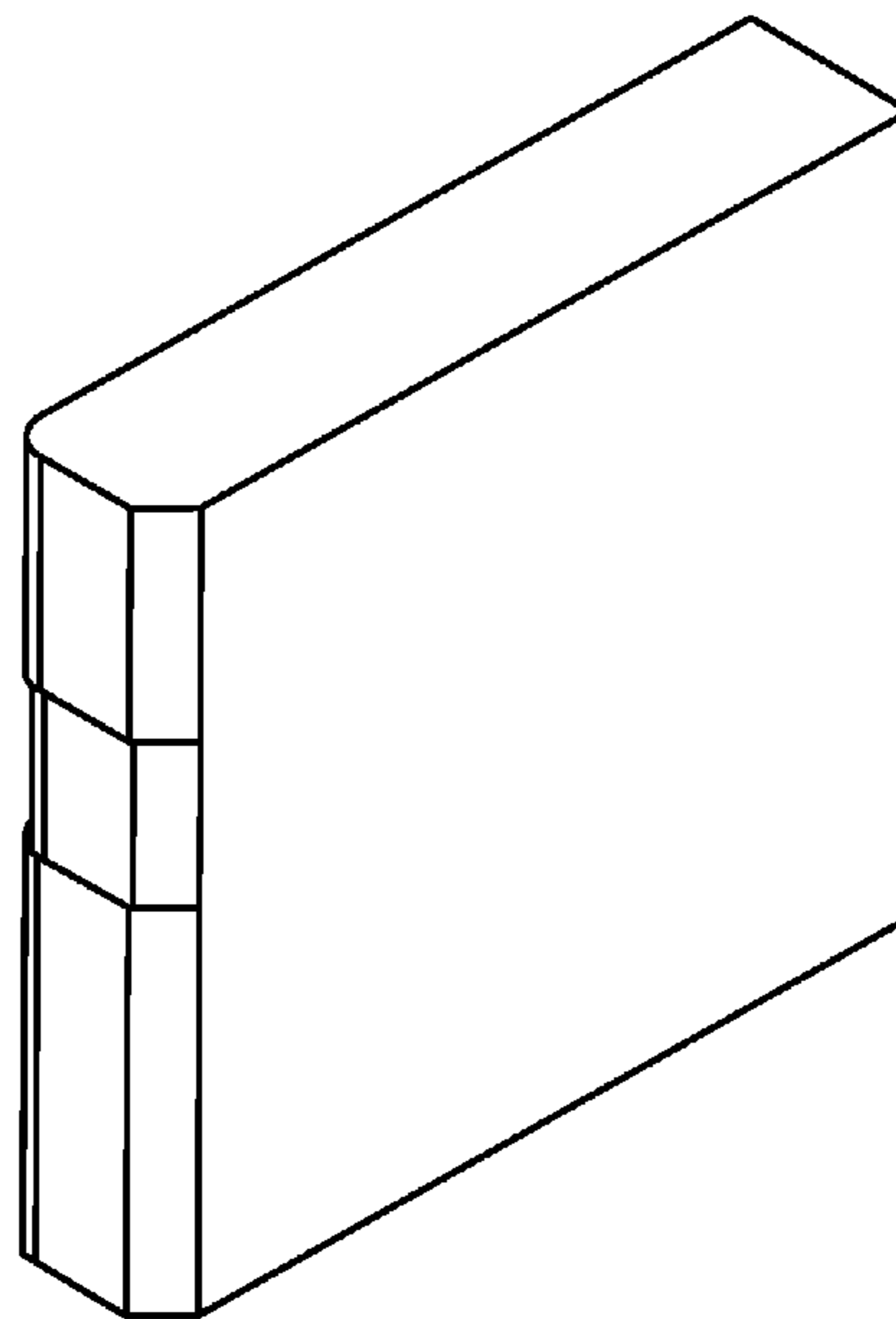

FIG. 169



FIG. 170

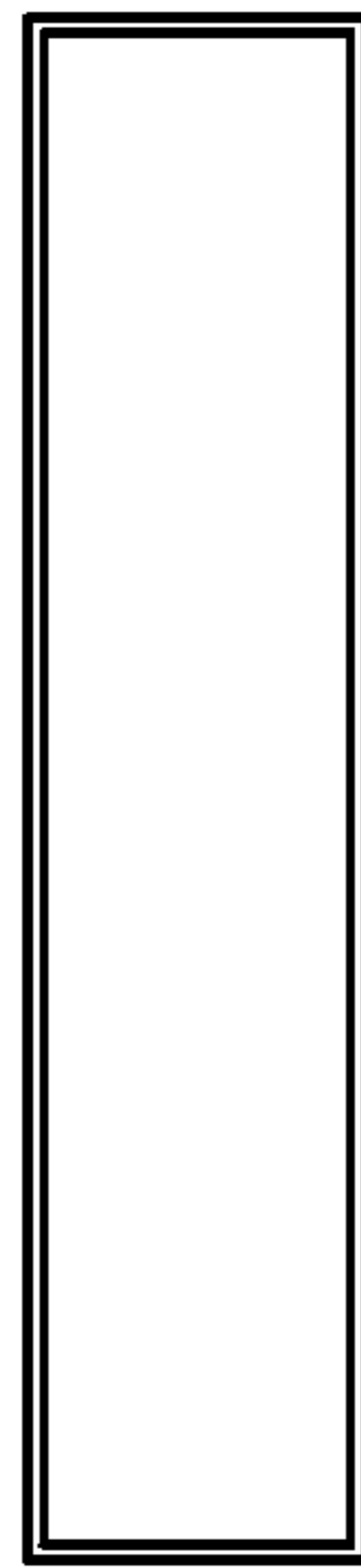

FIG. 171

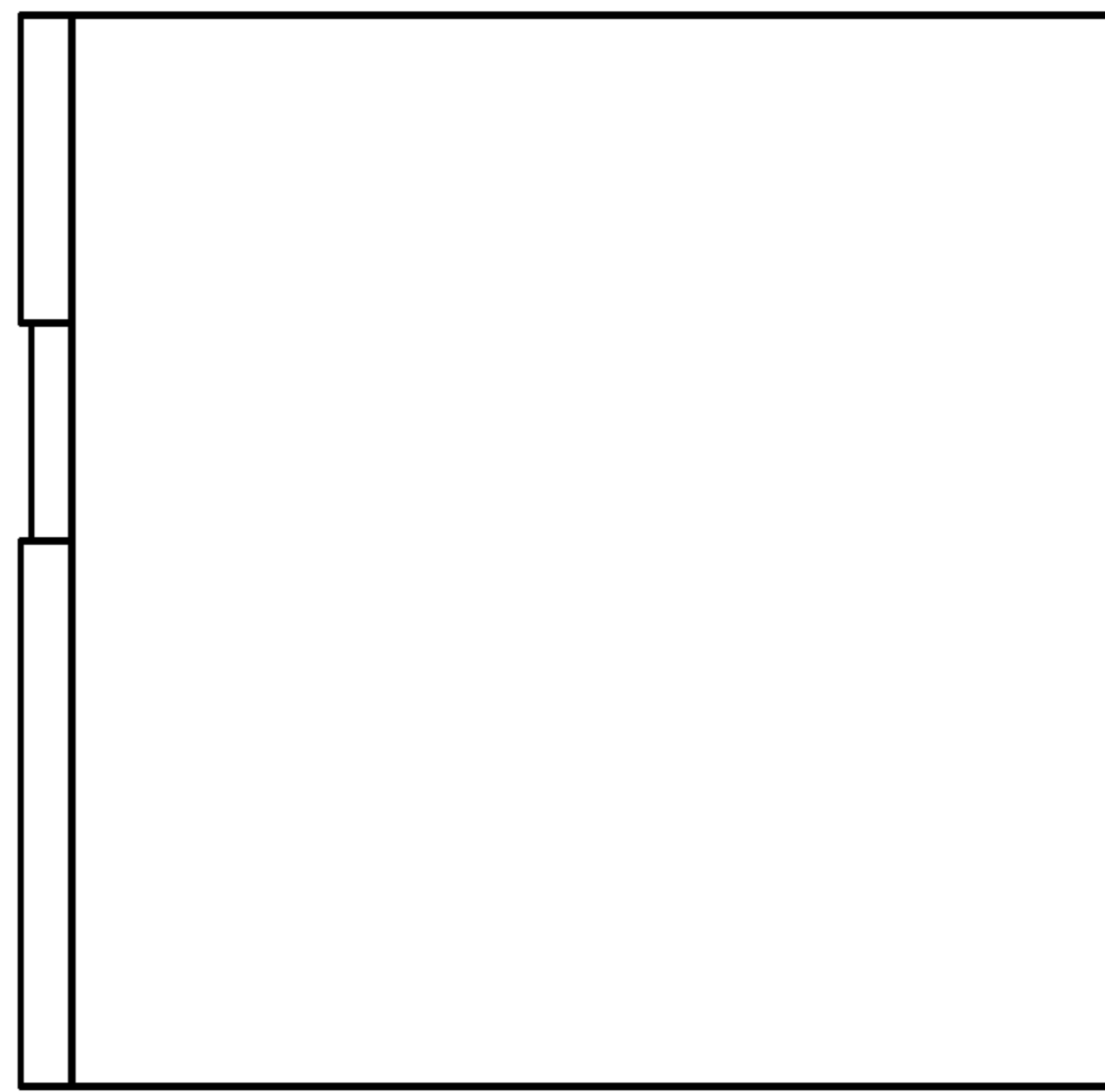

FIG. 172



FIG. 173

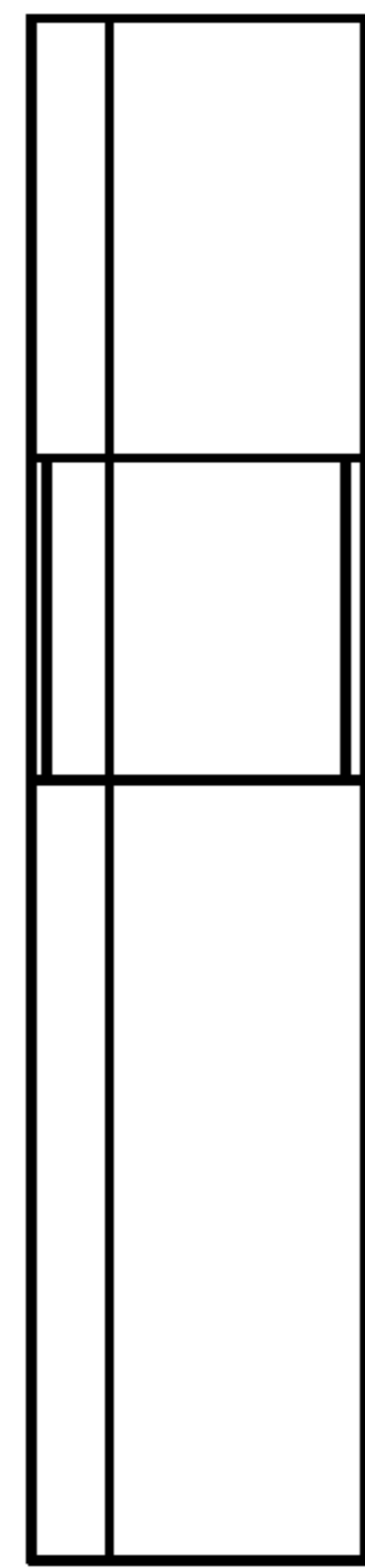

FIG. 181

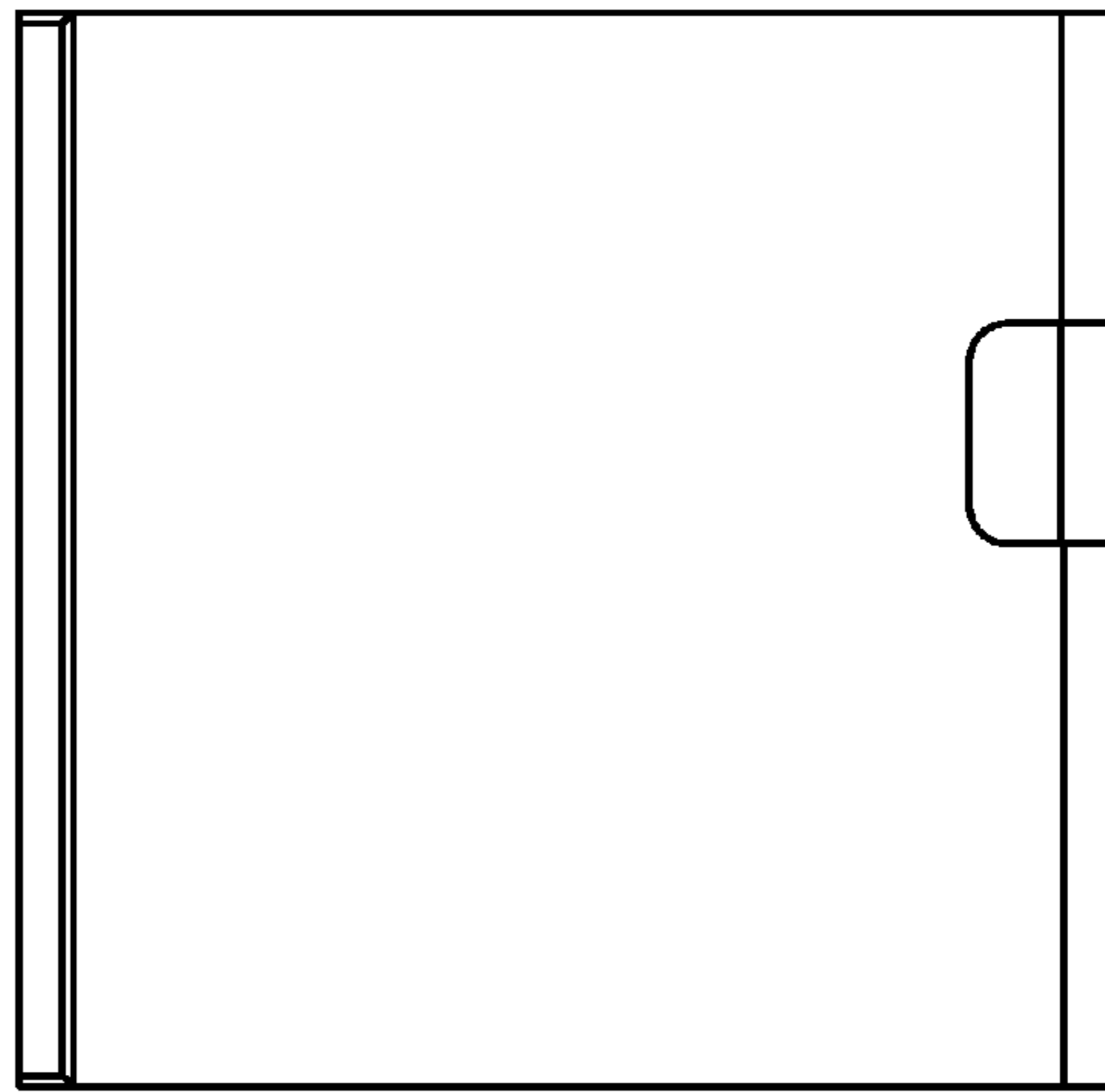

FIG. 182

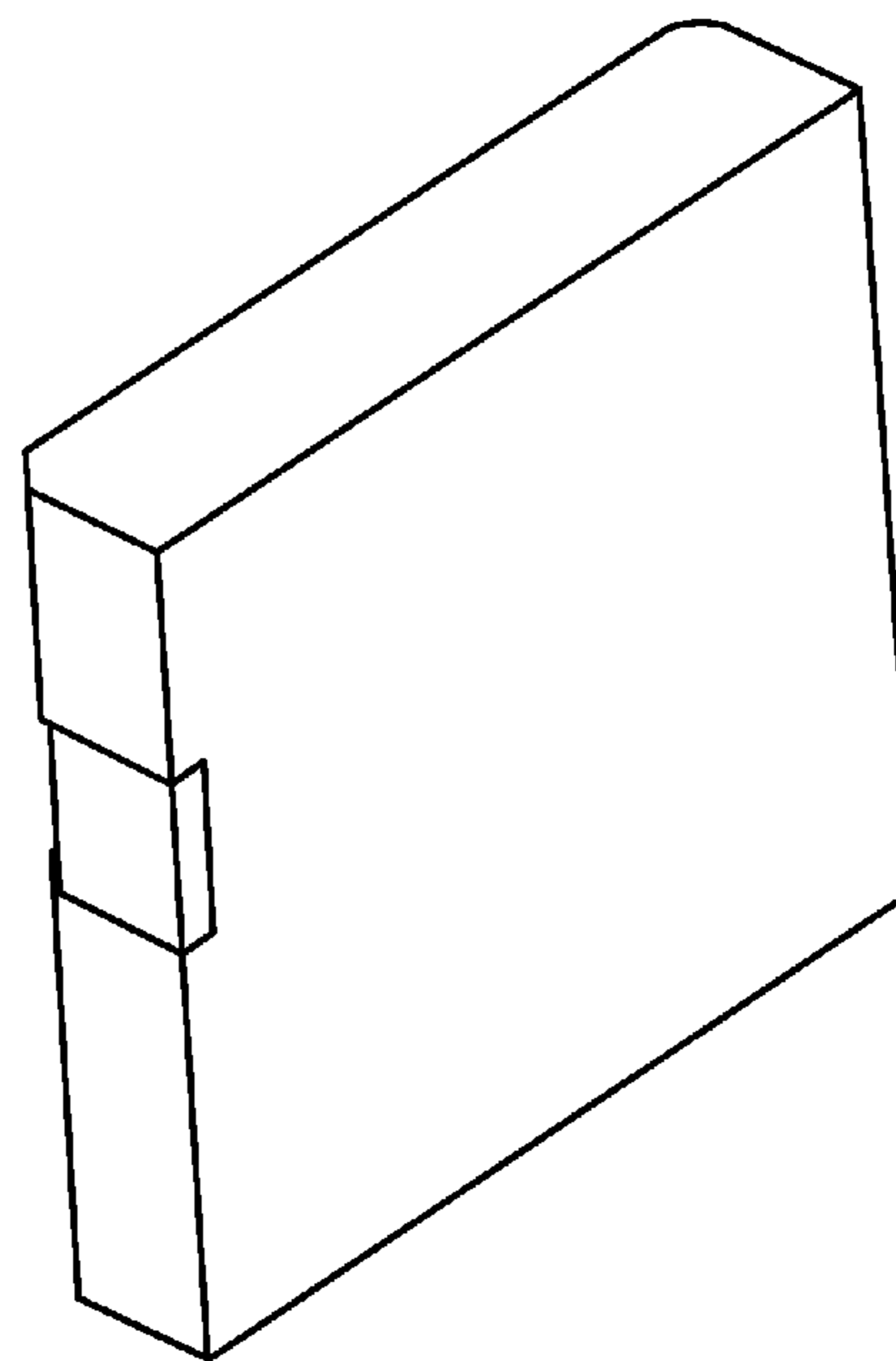

FIG. 176



FIG. 177

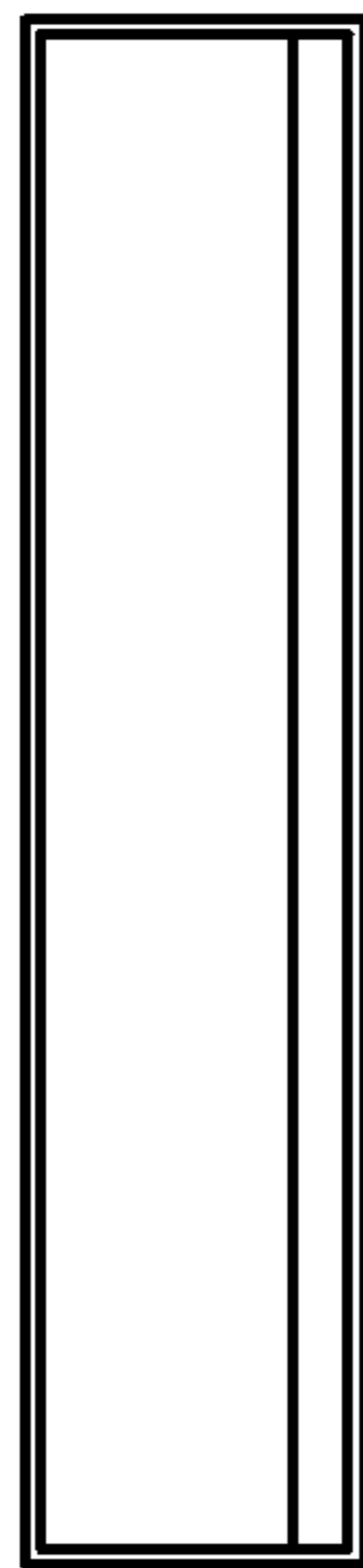

FIG. 178

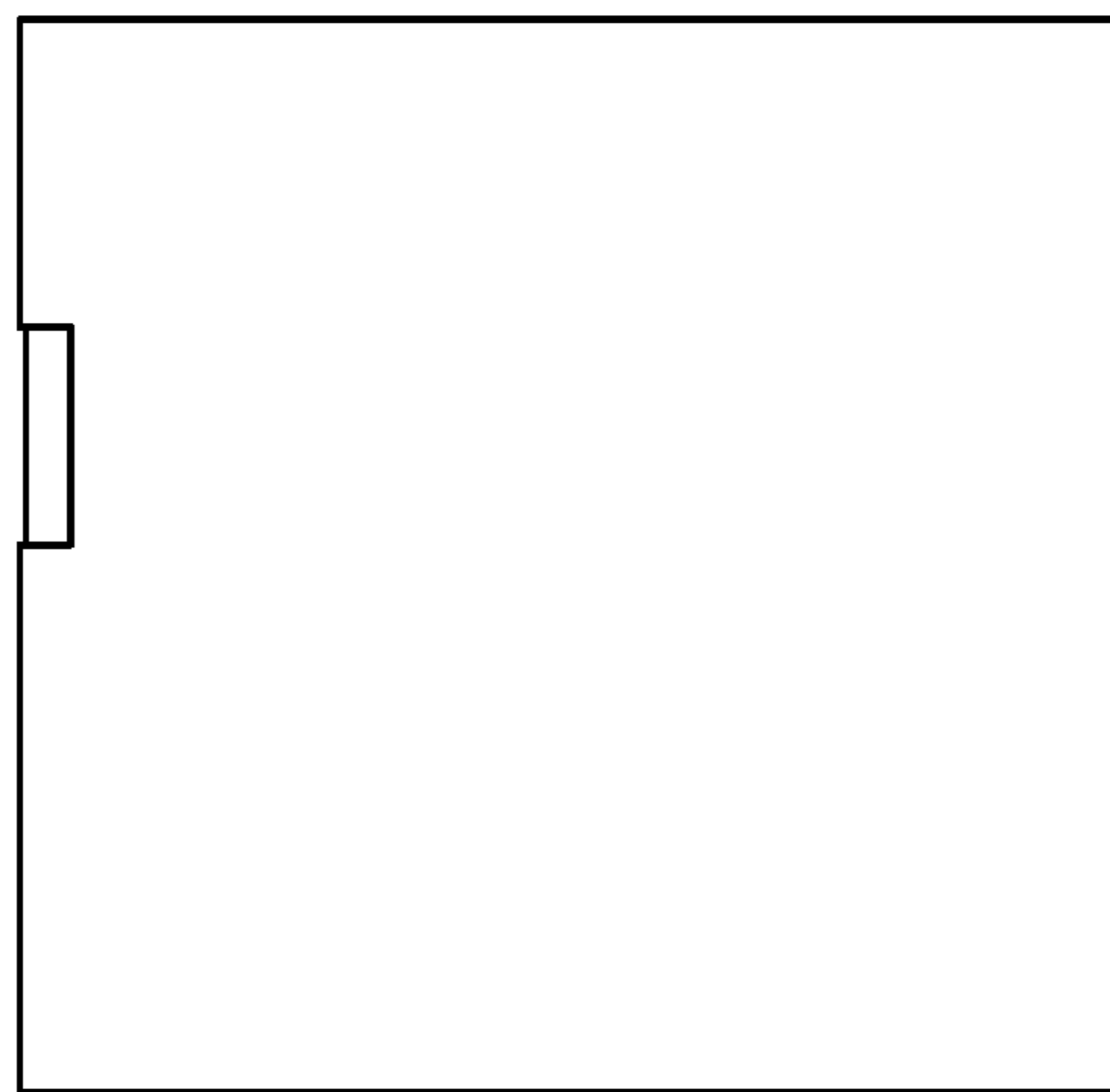

FIG. 179



FIG. 180