



US00D668515S

(12) **United States Design Patent**
Landberg

(10) **Patent No.:** **US D668,515 S**

(45) **Date of Patent:** **** Oct. 9, 2012**

(54) **TRIMMER**

(75) Inventor: **Gustav Landberg**, Stockholm (SE)

(73) Assignee: **Husqvarna AB**, Huskvarna (SE)

(**) Term: **14 Years**

(21) Appl. No.: **29/407,389**

(22) Filed: **Nov. 29, 2011**

(30) **Foreign Application Priority Data**

May 31, 2011 (EM) 001870882

(51) **LOC (9) Cl.** **08-01**

(52) **U.S. Cl.** **D8/8**

(58) **Field of Classification Search** D8/7, 8,
D8/9; 30/208, 276, 228, 382, 383, 216; 56/12.7,
56/233-237; 172/13; D15/1

See application file for complete search history.

(56) **References Cited**

U.S. PATENT DOCUMENTS

5,581,891 A * 12/1996 Wheeler et al. 30/216
D434,620 S * 12/2000 Martin D8/8

D505,844 S * 6/2005 Houghton D8/8
D543,805 S * 6/2007 Houghton D8/8
D623,909 S * 9/2010 Tate et al. D8/8

* cited by examiner

Primary Examiner — Sheryl Lane

(74) *Attorney, Agent, or Firm* — Nelson Mullins Riley & Scarborough LLP

(57) **CLAIM**

I claim, the ornamental design for a trimmer, as shown and described.

DESCRIPTION

FIG. 1 is a top perspective view of a trimmer in accordance with an embodiment of the present invention; FIG. 2 is a right side view of the trimmer of FIG. 1; FIG. 3 is a left side view of the trimmer of FIG. 1; FIG. 4 is a top plan view of the trimmer of FIG. 1; FIG. 5 is a bottom plan view of the trimmer of FIG. 1; FIG. 6 is a front view of the trimmer of FIG. 1; and, FIG. 7 is a rear view of the trimmer of FIG. 1. The broken lines of FIGS. 1-7 are illustrative of the visible environmental structure of the trimmer and form no part of the claimed design.

1 Claim, 6 Drawing Sheets

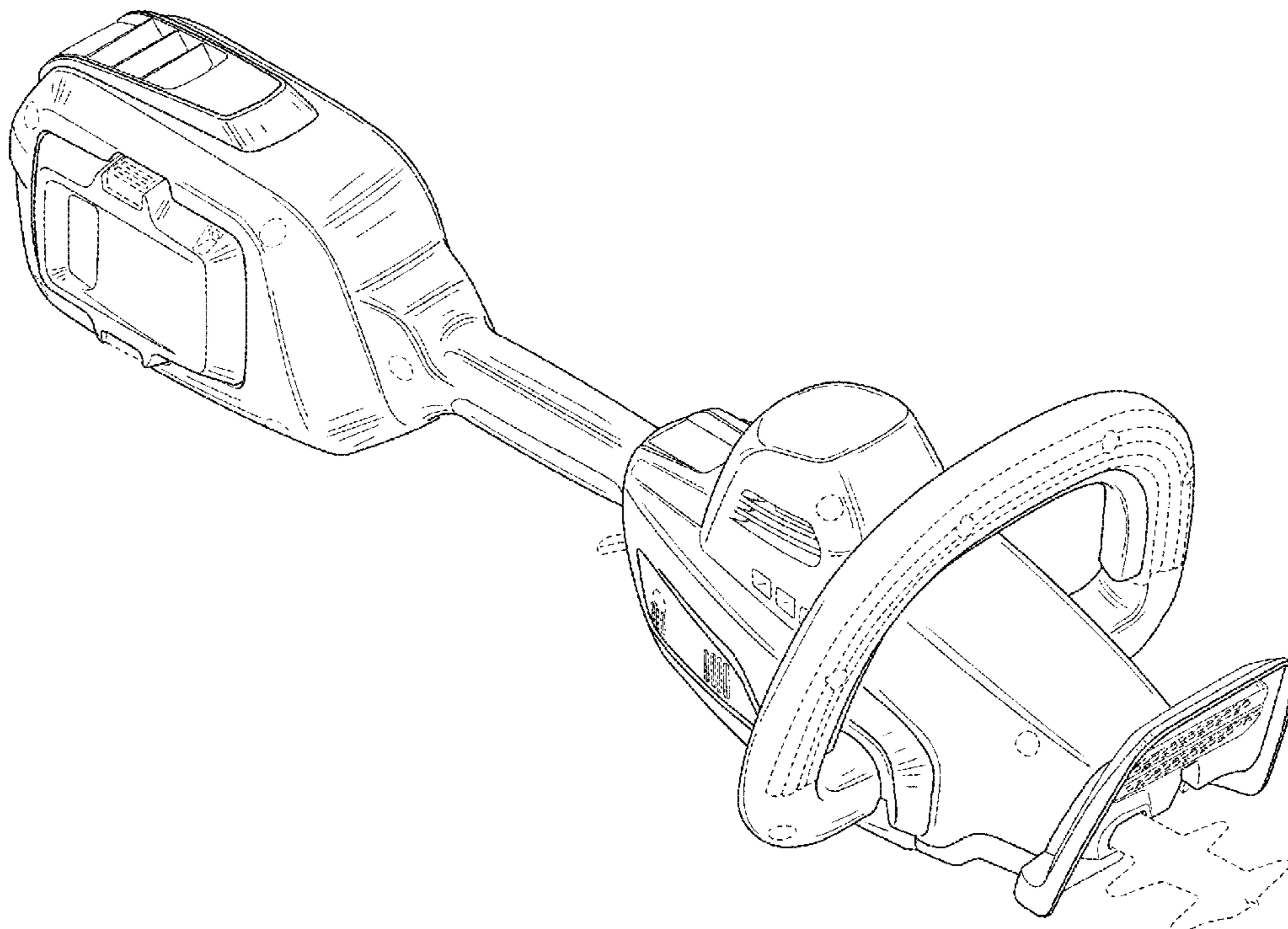

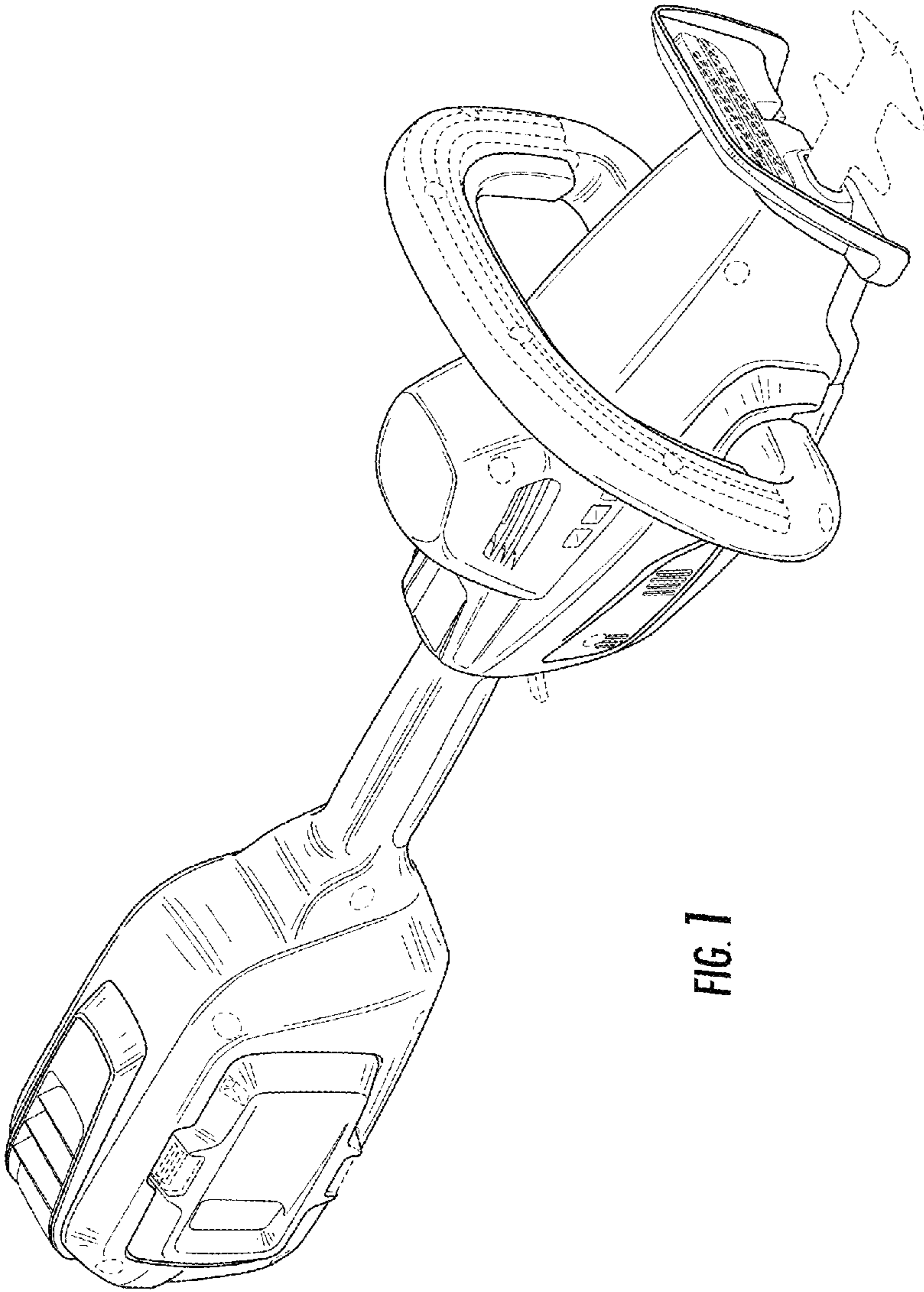

FIG. 1

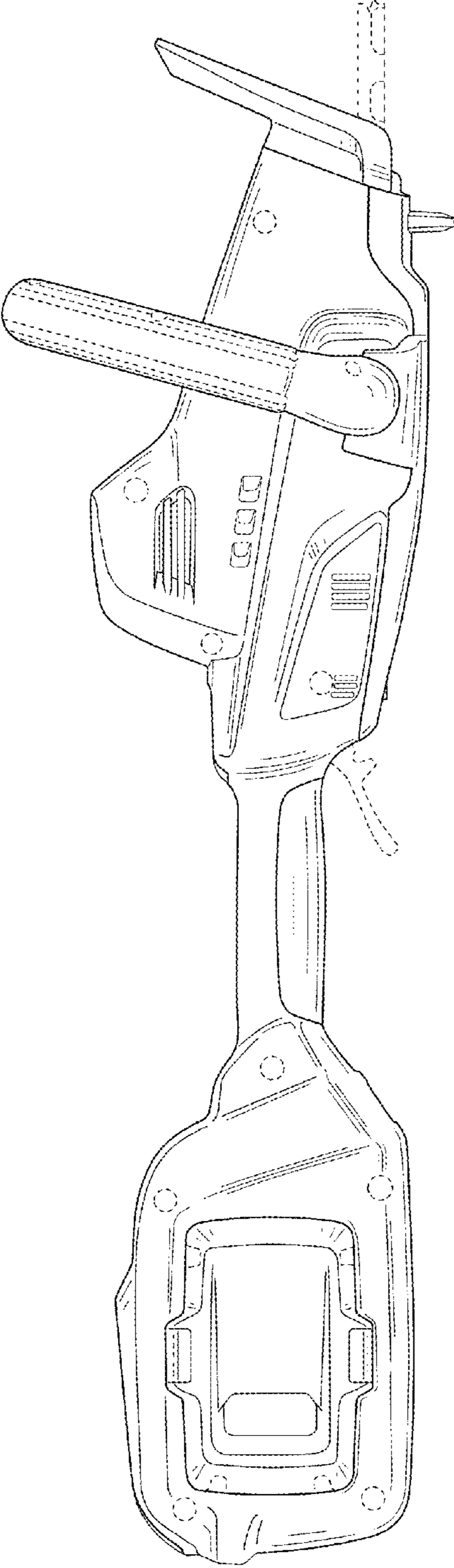

FIG. 2

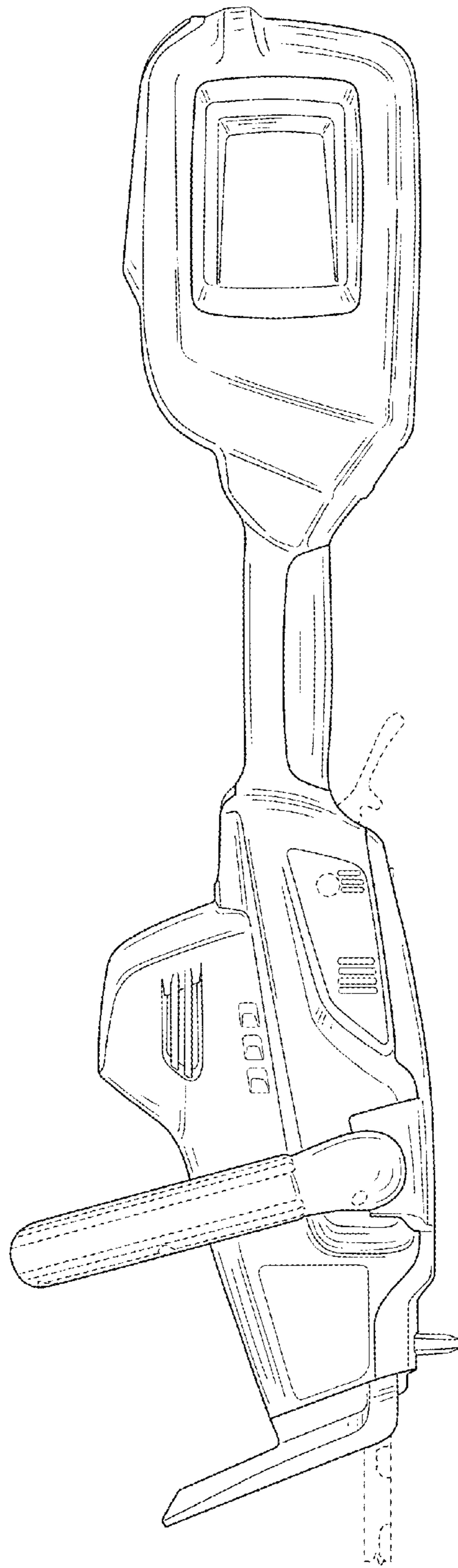

FIG. 3

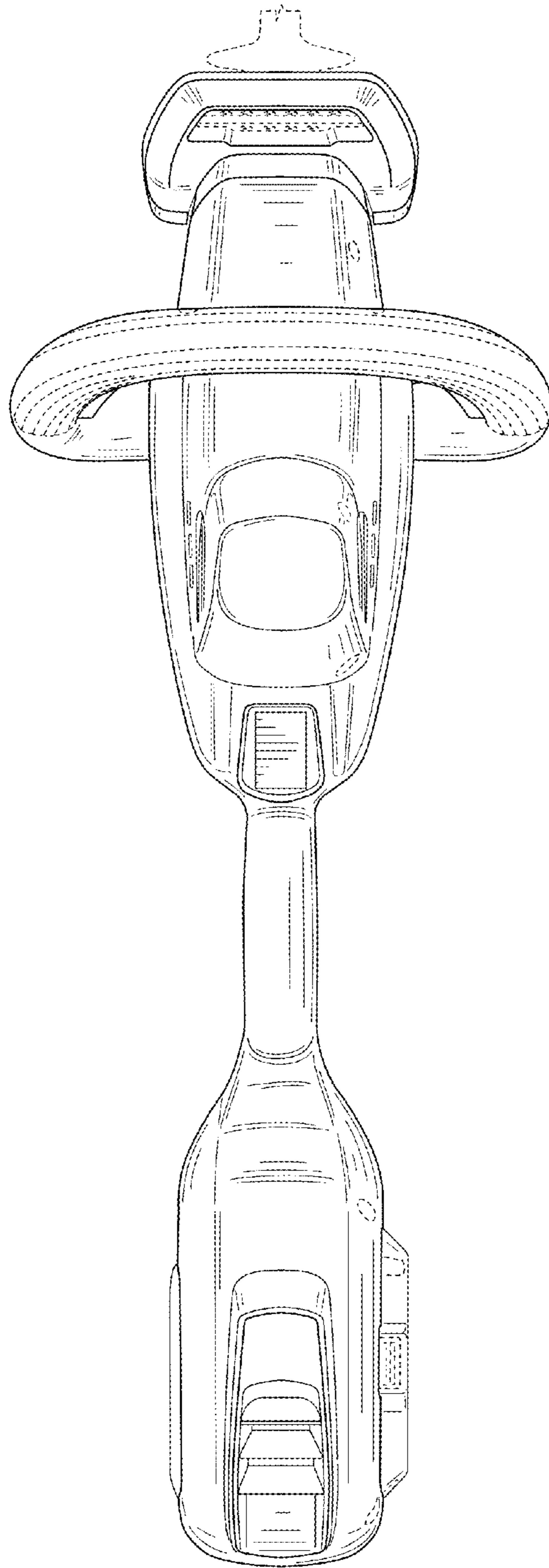

FIG. 4

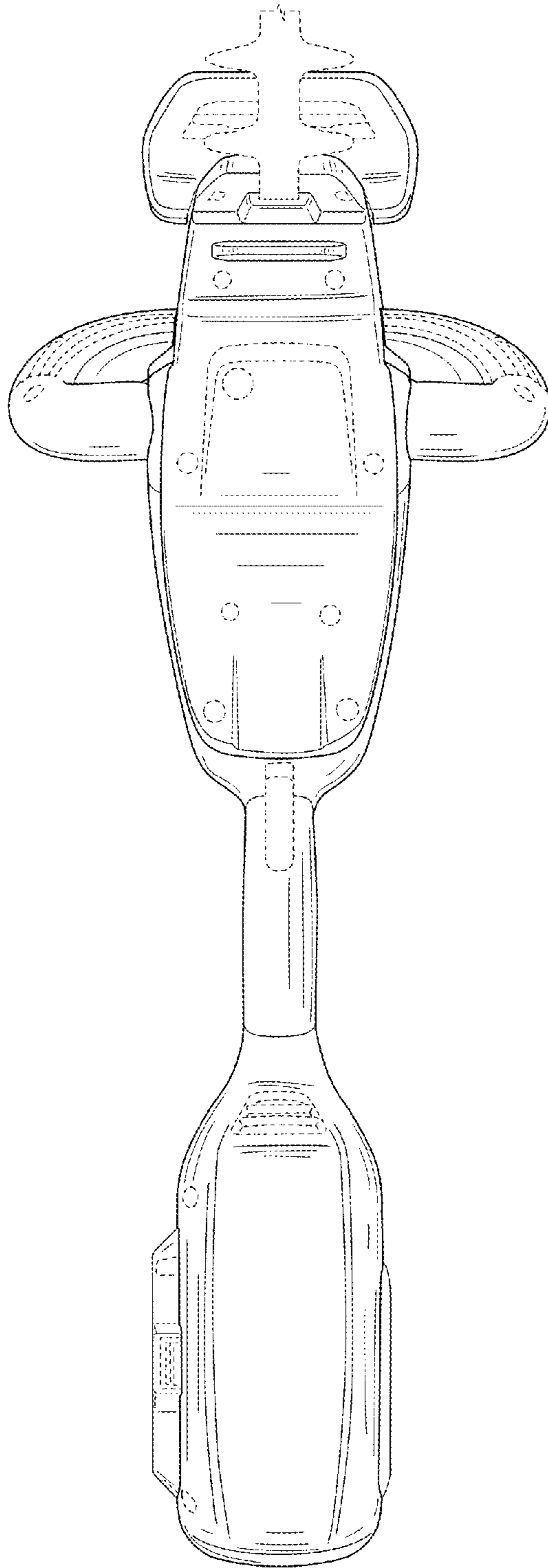

FIG. 5

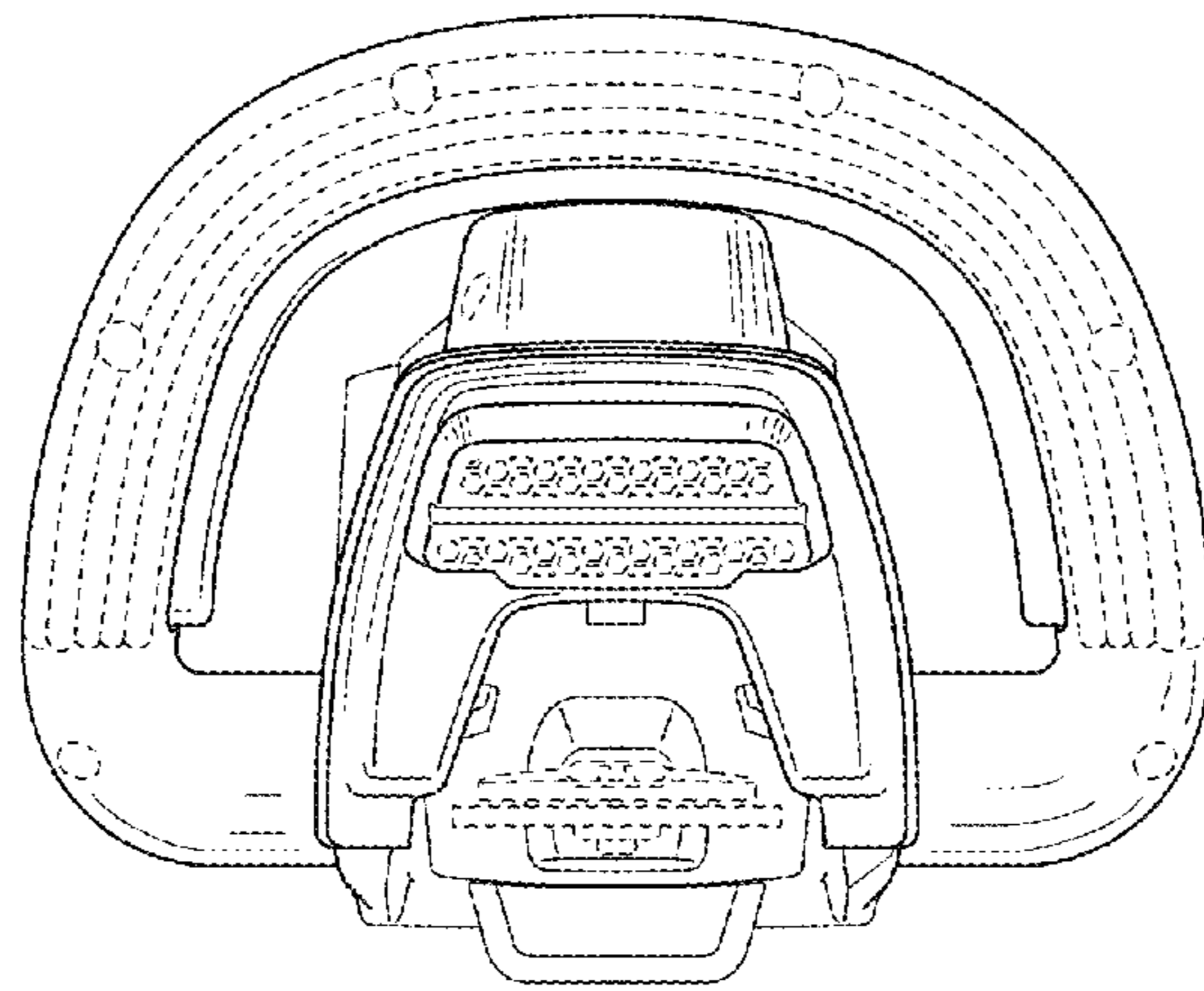

FIG. 6

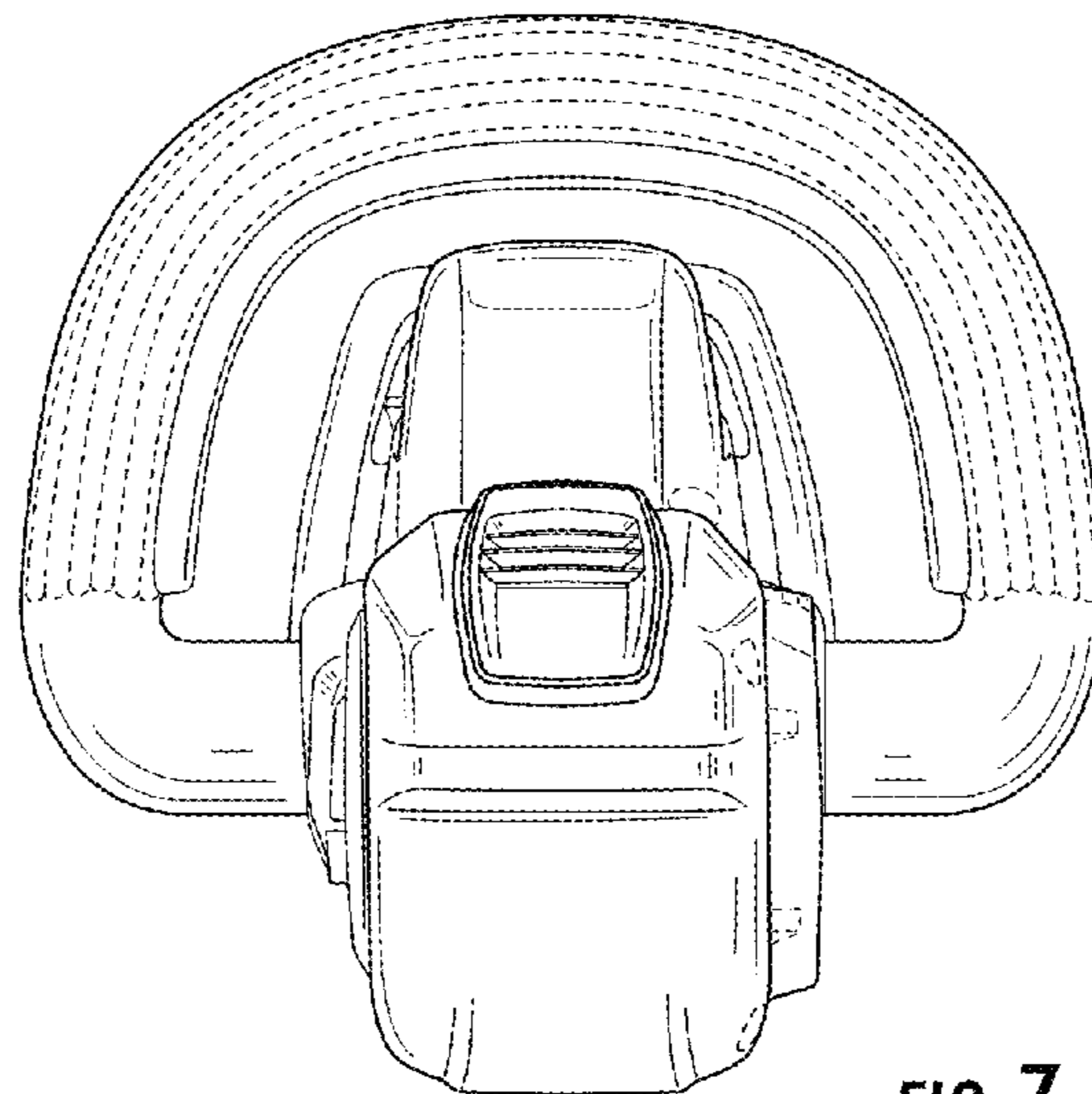

FIG. 7