



US00D668488S

(12) **United States Design Patent**
Nazario

(10) **Patent No.:** **US D668,488 S**

(45) **Date of Patent:** **** Oct. 9, 2012**

(54) **BATH ACCESSORY POST**

(75) Inventor: **Mercedita Andrew Nazario**, Chicago, IL (US)

(73) Assignee: **Liberty Hardware Mfg. Corp.**, Winston-Salem, NC (US)

(**) Term: **14 Years**

(21) Appl. No.: **29/414,333**

(22) Filed: **Feb. 28, 2012**

(51) **LOC (9) Cl.** **23-02**

(52) **U.S. Cl.** **D6/524**

(58) **Field of Classification Search** D6/518–524,
D6/546–550; D8/300, 370, 315; 108/28–29;
211/13.1, 16, 85.5, 86.01, 87.01, 88.04, 100,
211/105.1, 105.2, 106, 113, 123, 181.1, 182–183;
248/49, 175, 176.1, 200, 201, 205.1, 251,
248/302, 309.1, 315; 242/570, 590, 595–598
See application file for complete search history.

(56) **References Cited**

U.S. PATENT DOCUMENTS

D416,419 S *	11/1999	Chen	D6/550
D520,283 S *	5/2006	Wu	D6/550
D522,786 S *	6/2006	Chu et al.	D6/550
D532,638 S *	11/2006	Berberet et al.	D6/550
D562,606 S *	2/2008	Chen et al.	D6/524
D633,738 S *	3/2011	Bauer et al.	D6/524

* cited by examiner

Primary Examiner — Brian N Vinson

(74) *Attorney, Agent, or Firm* — Lora J. Graentzdoerffer; Nirav D. Parikh; Edgar A. Zarins

(57) **CLAIM**

The ornamental design for a bath accessory post, as shown and described.

DESCRIPTION

FIG. 1 is a perspective view thereof;
 FIG. 2 is an alternative perspective view thereof;
 FIG. 3 is a right side elevational view thereof;
 FIG. 4 is a left side elevational view thereof;
 FIG. 5 is a front elevational view thereof;
 FIG. 6 is a rear elevational view thereof;
 FIG. 7 is a top plan view thereof; and
 FIG. 8 is a bottom plan view thereof;
 FIG. 9 is a perspective view of an alternate embodiment of the invention;
 FIG. 10 is a right side elevational view of an alternate embodiment of the invention;
 FIG. 11 is a left side elevational view of an alternate embodiment of the invention;
 FIG. 12 is a front elevational view of an alternate embodiment of the invention;
 FIG. 13 is a rear elevational view of an alternate embodiment of the invention;
 FIG. 14 is a top plan view of an alternate embodiment of the invention; and,
 FIG. 15 is a bottom plan view of an alternate embodiment of the invention.
 The broken-line disclosure in the views represents portions of the article in which the claimed design is embodied, but which form no part of the claimed design.

1 Claim, 8 Drawing Sheets

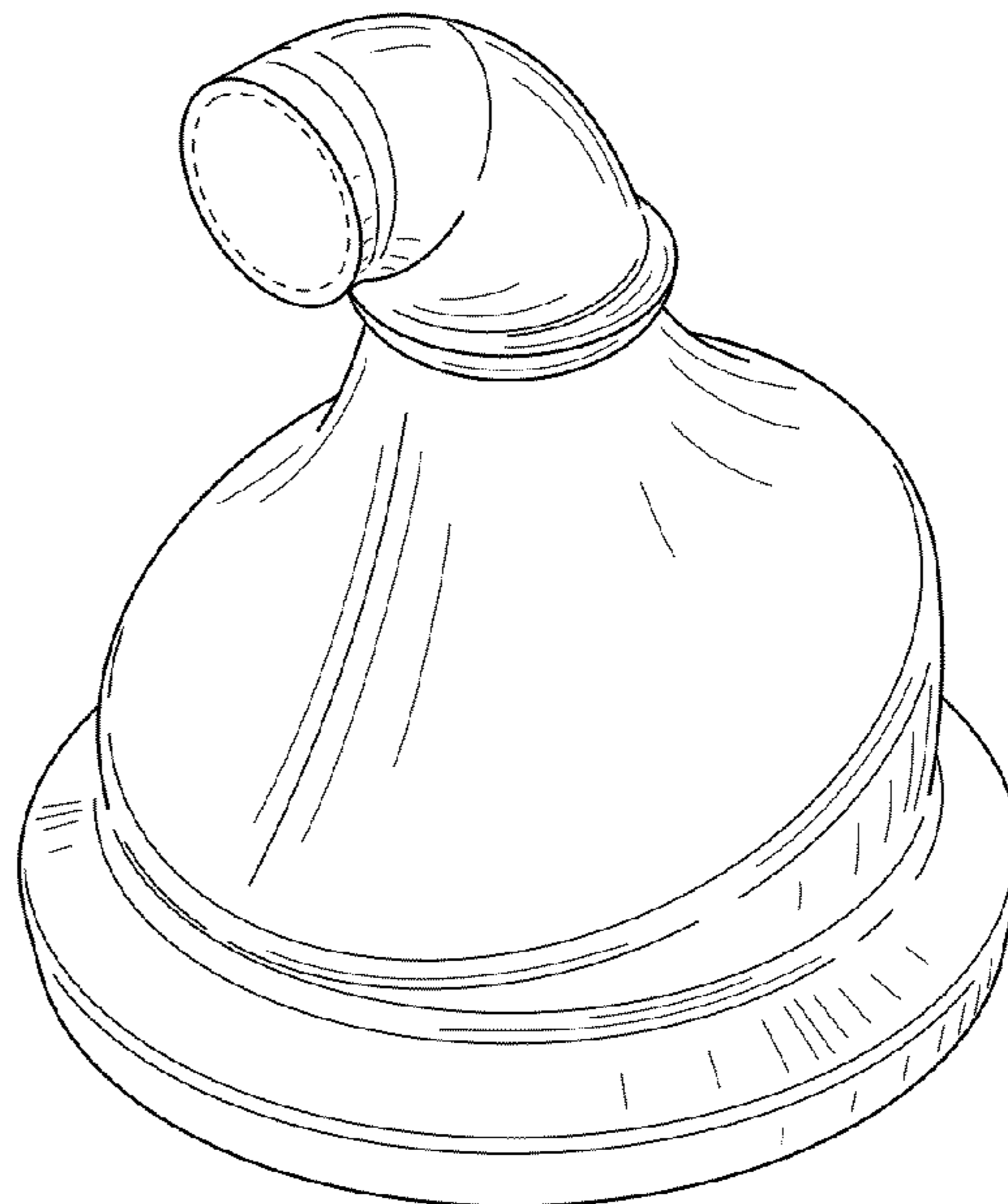
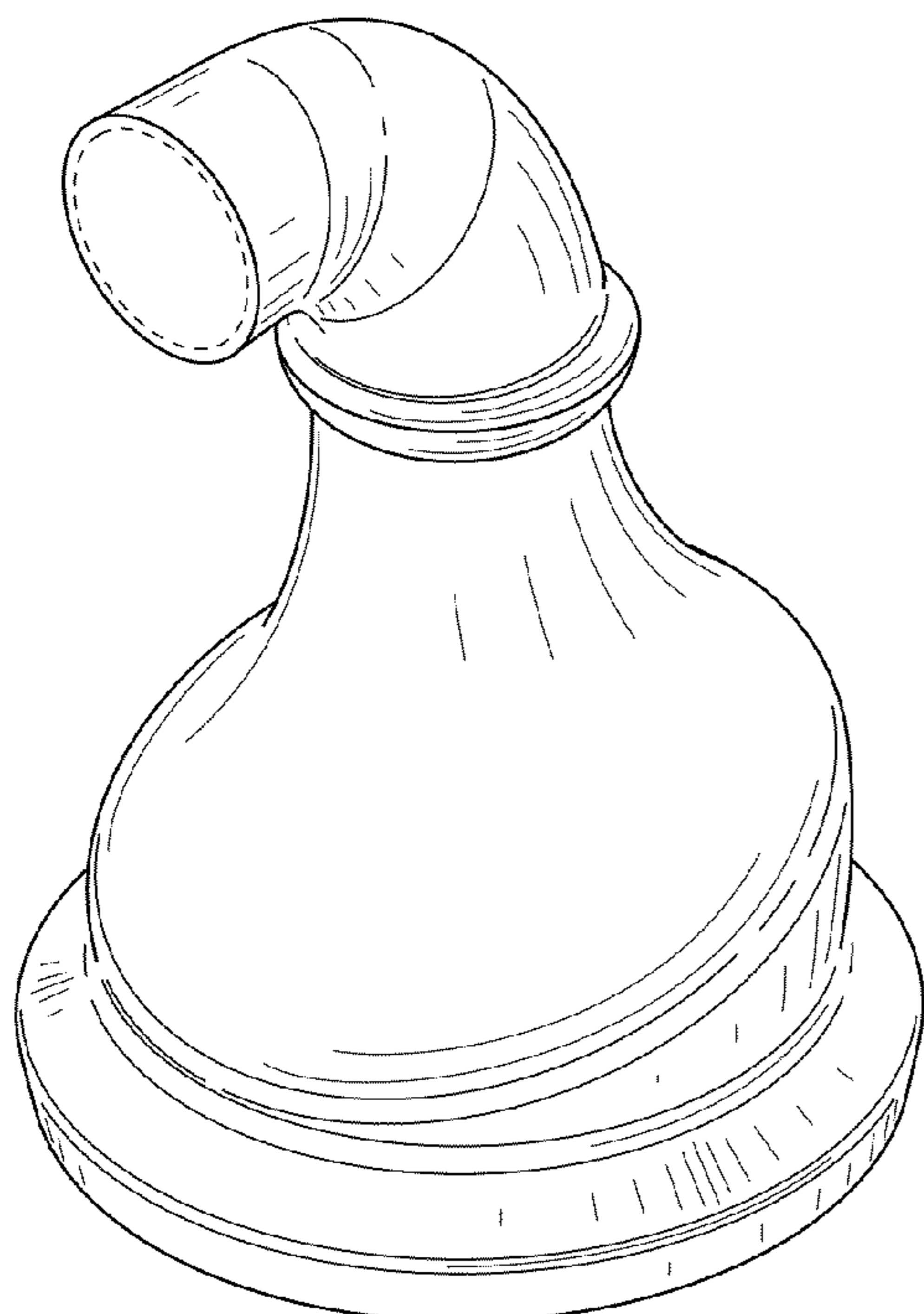

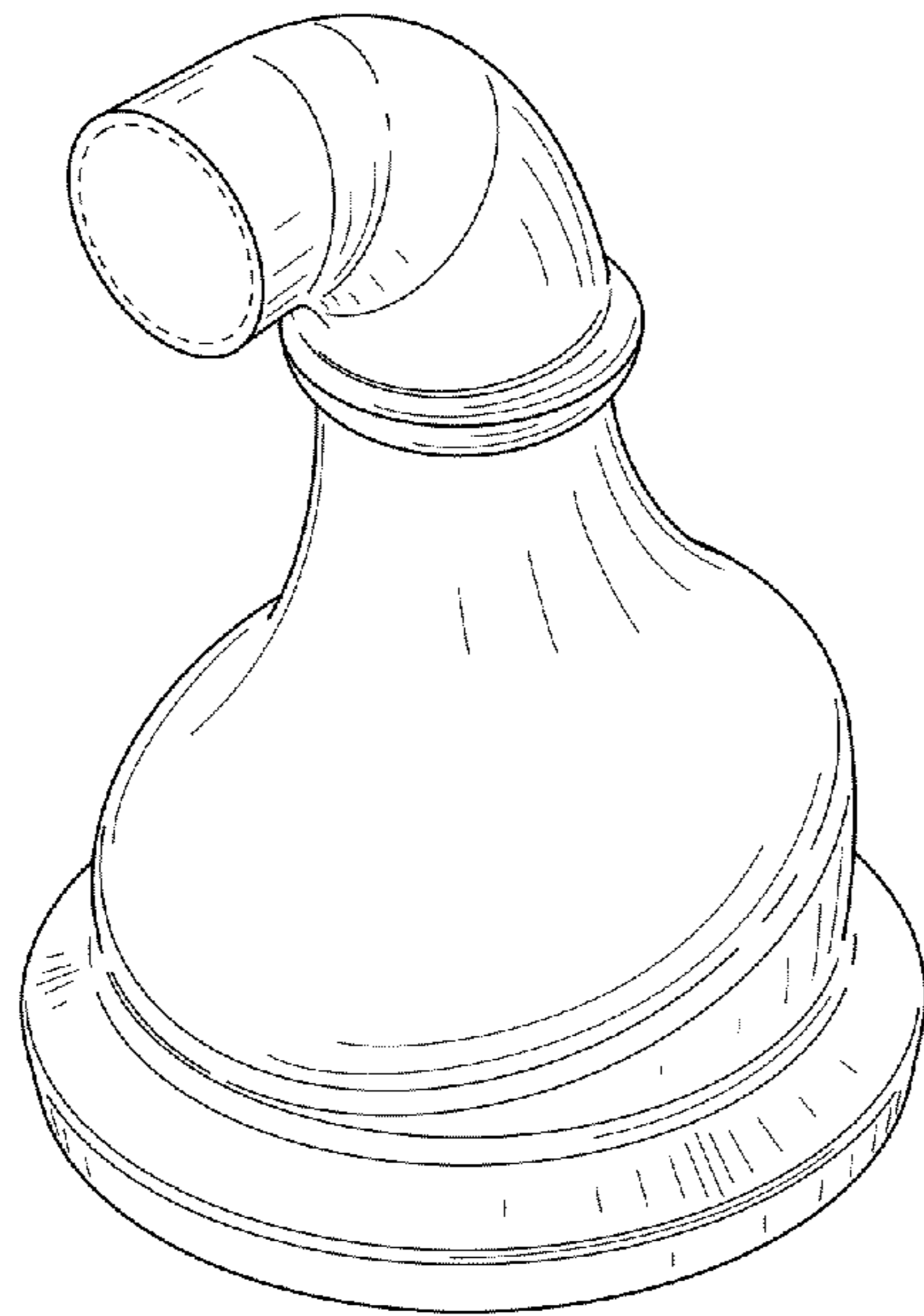

FIG. 1

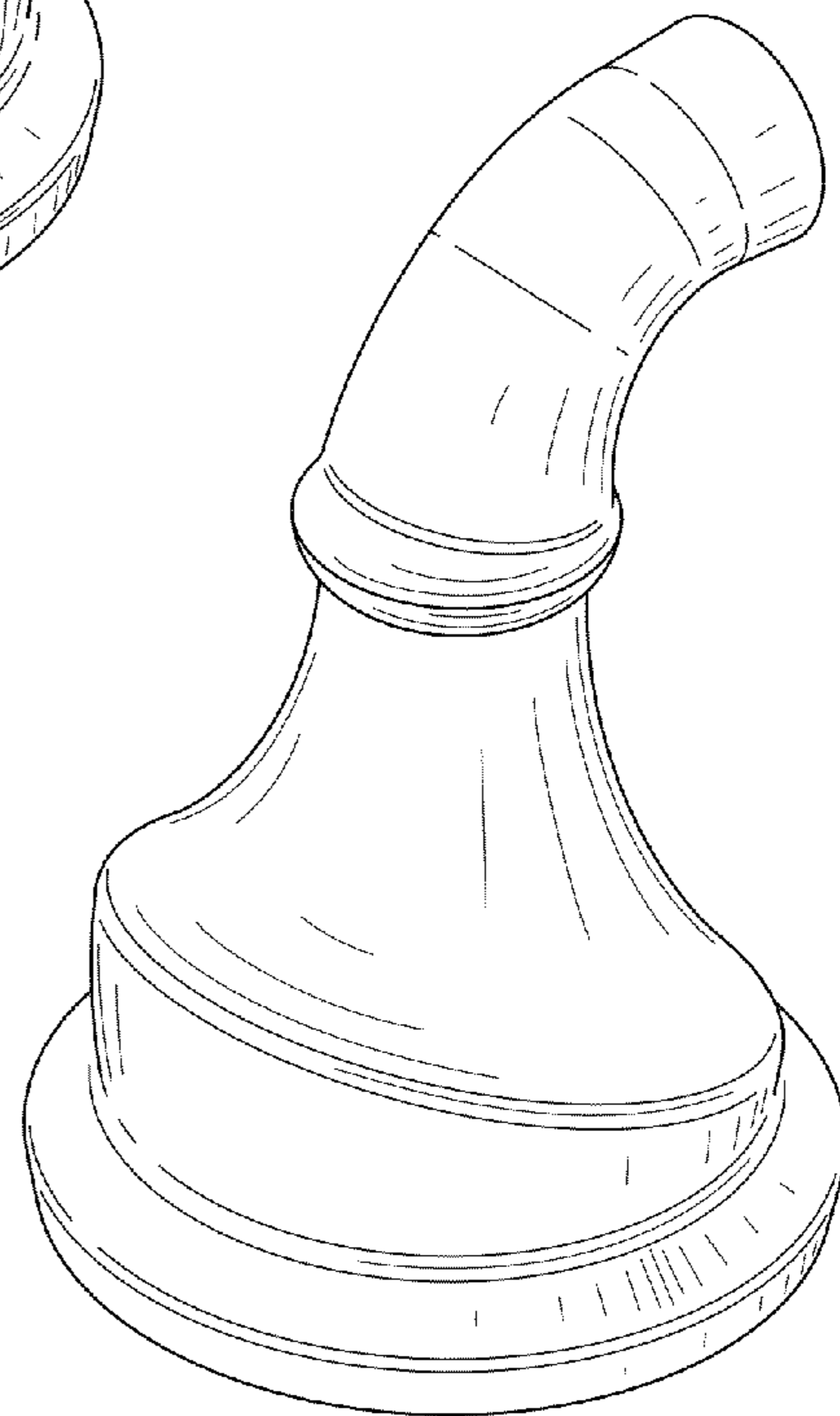

FIG. 2

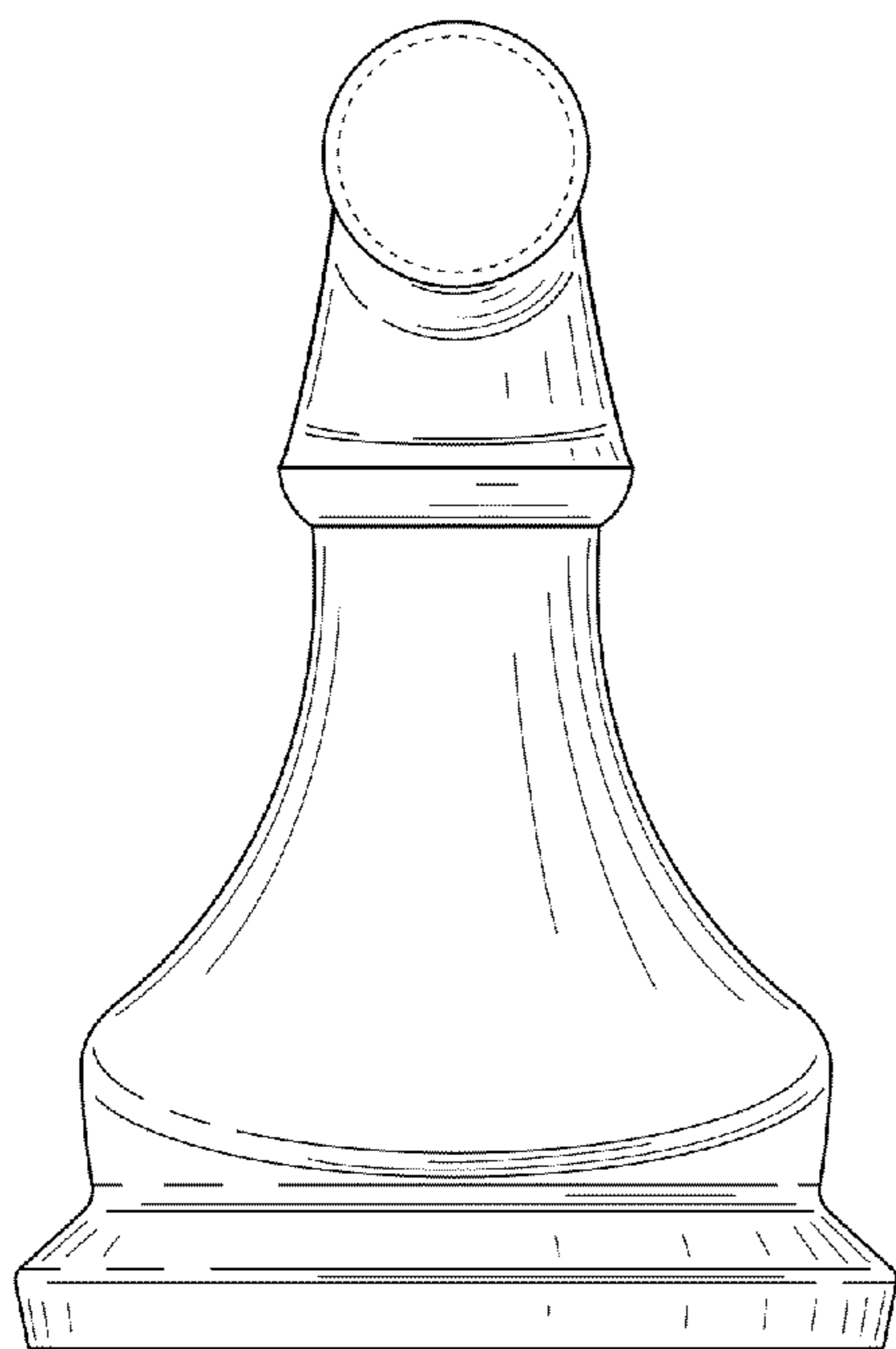

FIG. 3

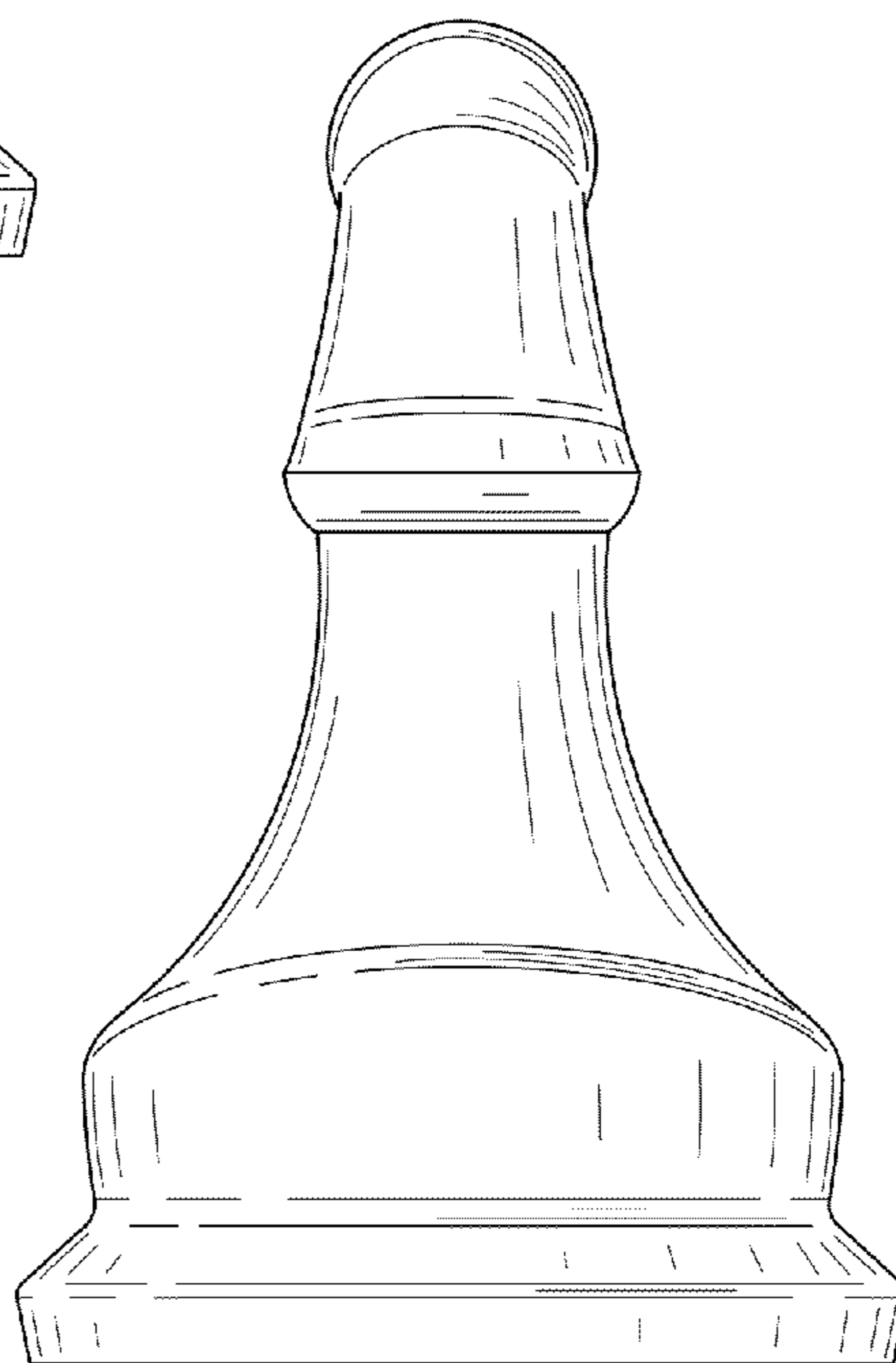

FIG. 4

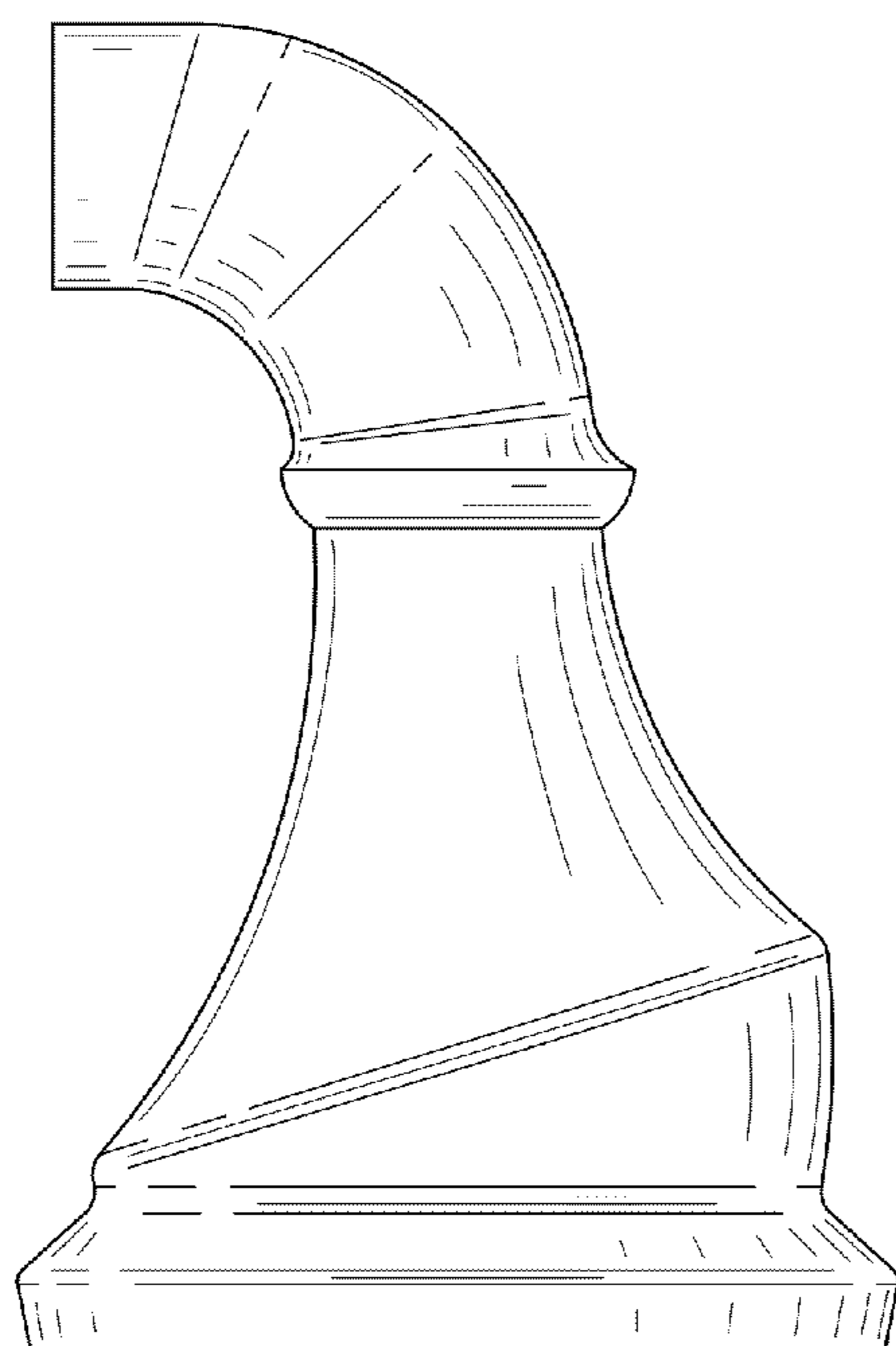

FIG. 5

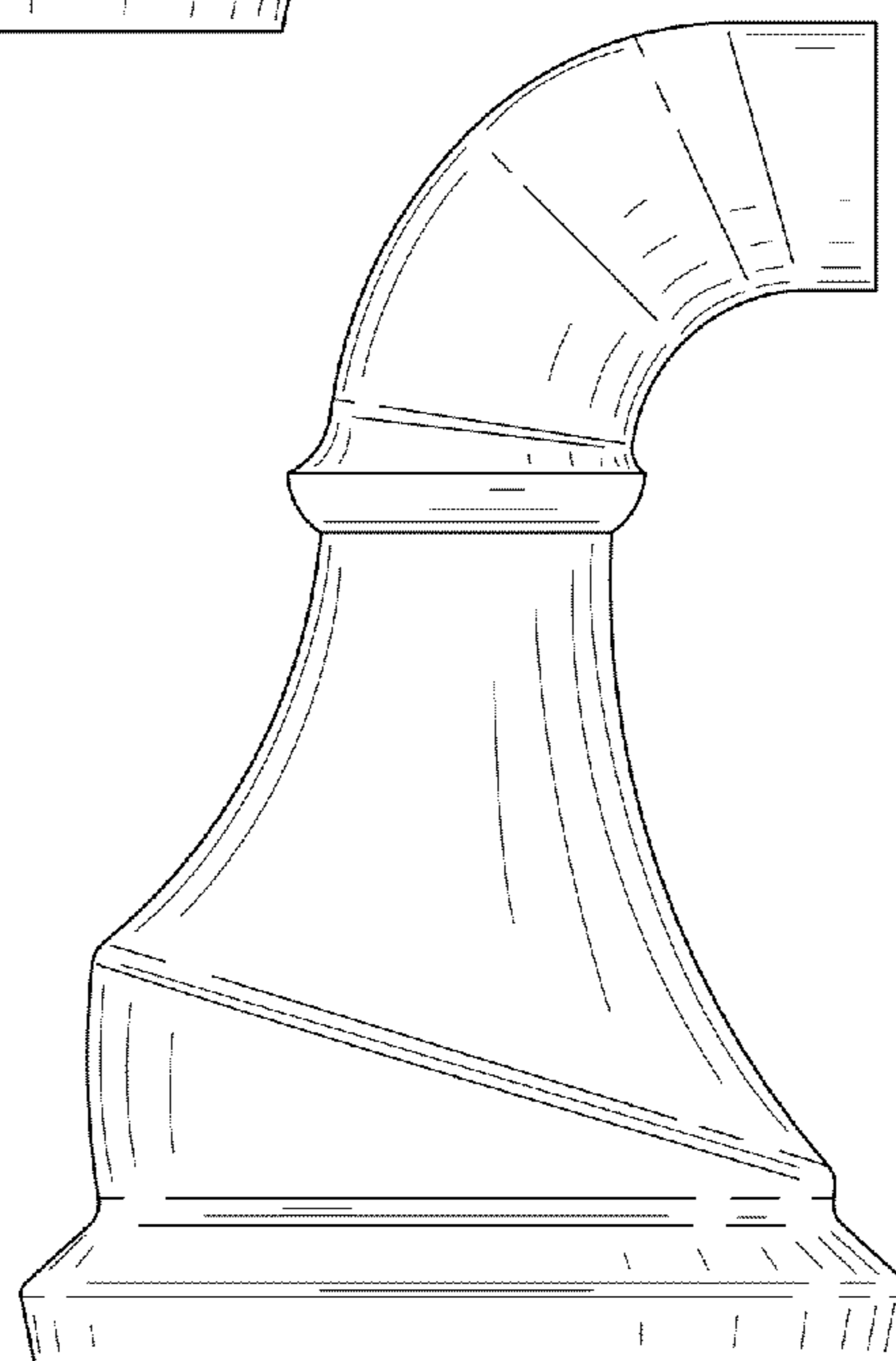

FIG. 6

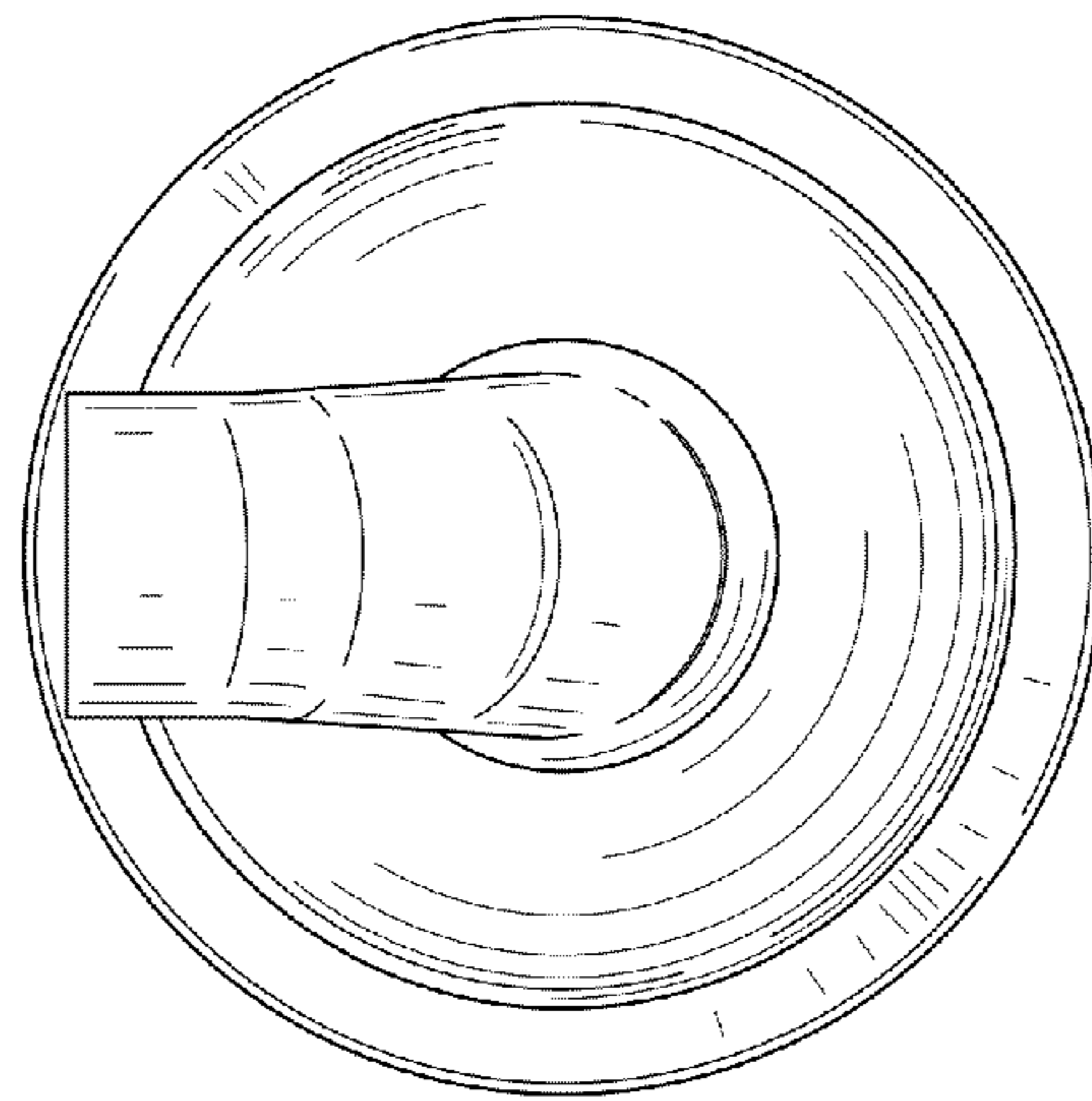

FIG. 7

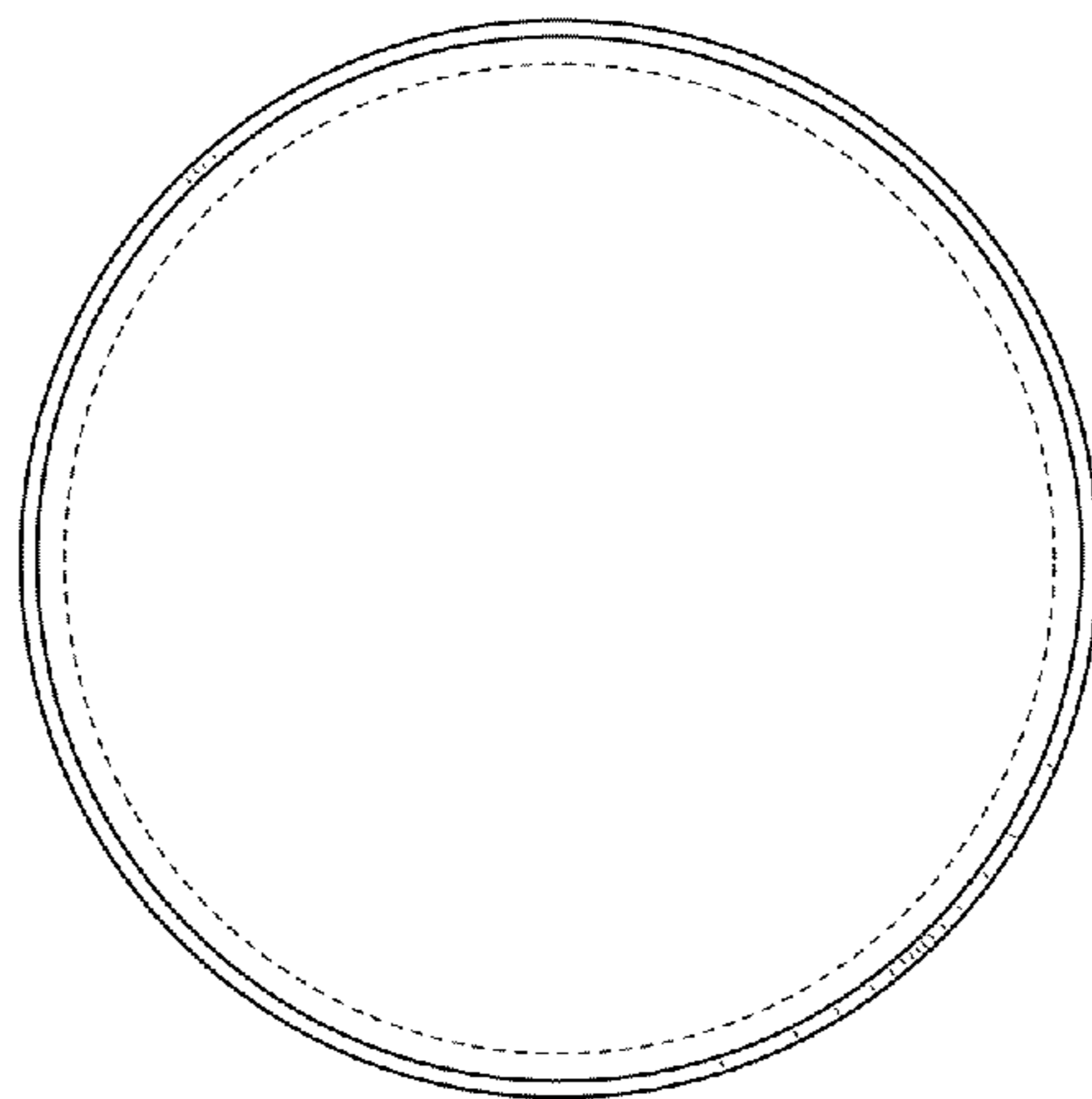

FIG. 8

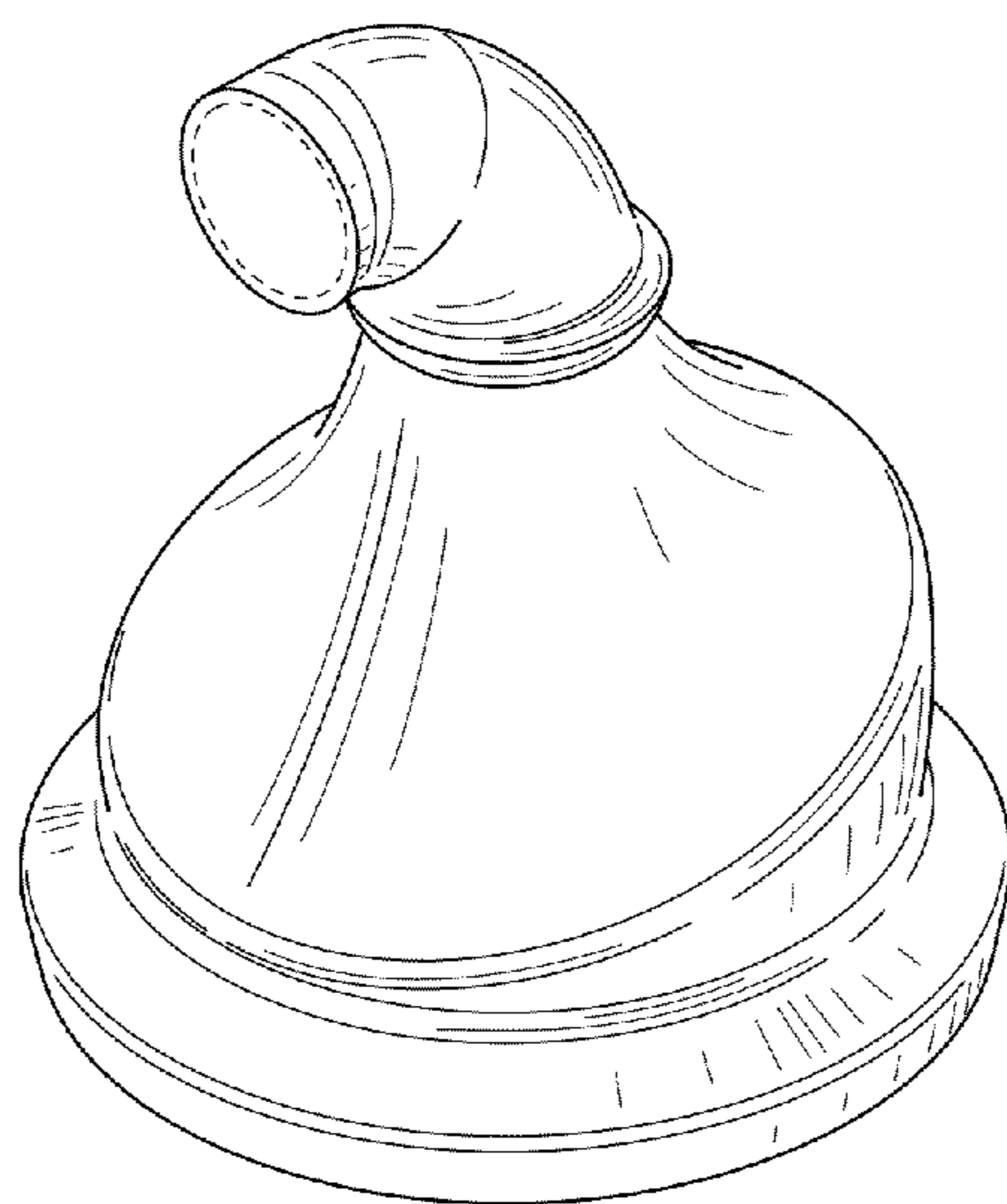

FIG. 9

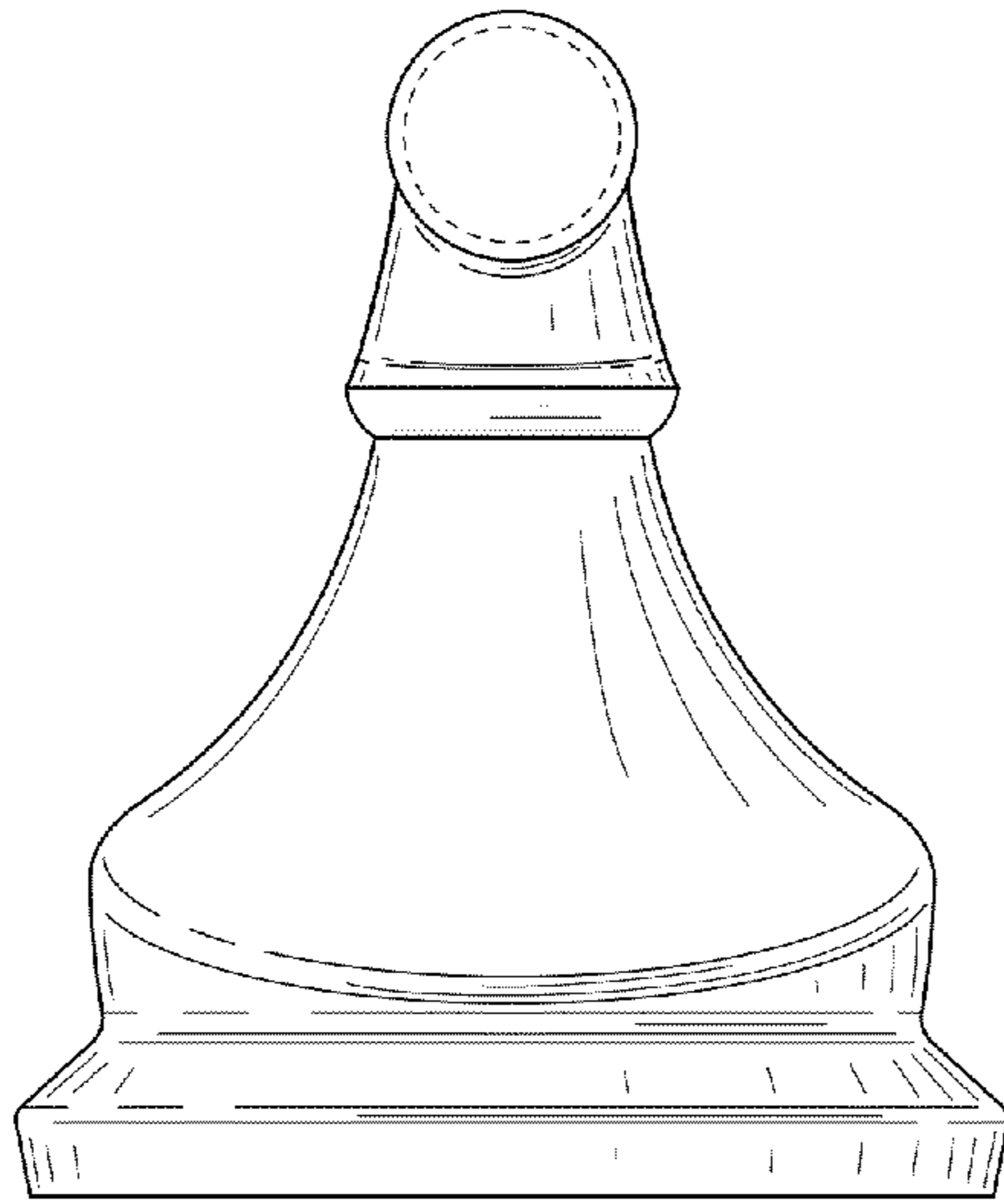

FIG. 10



FIG. 11

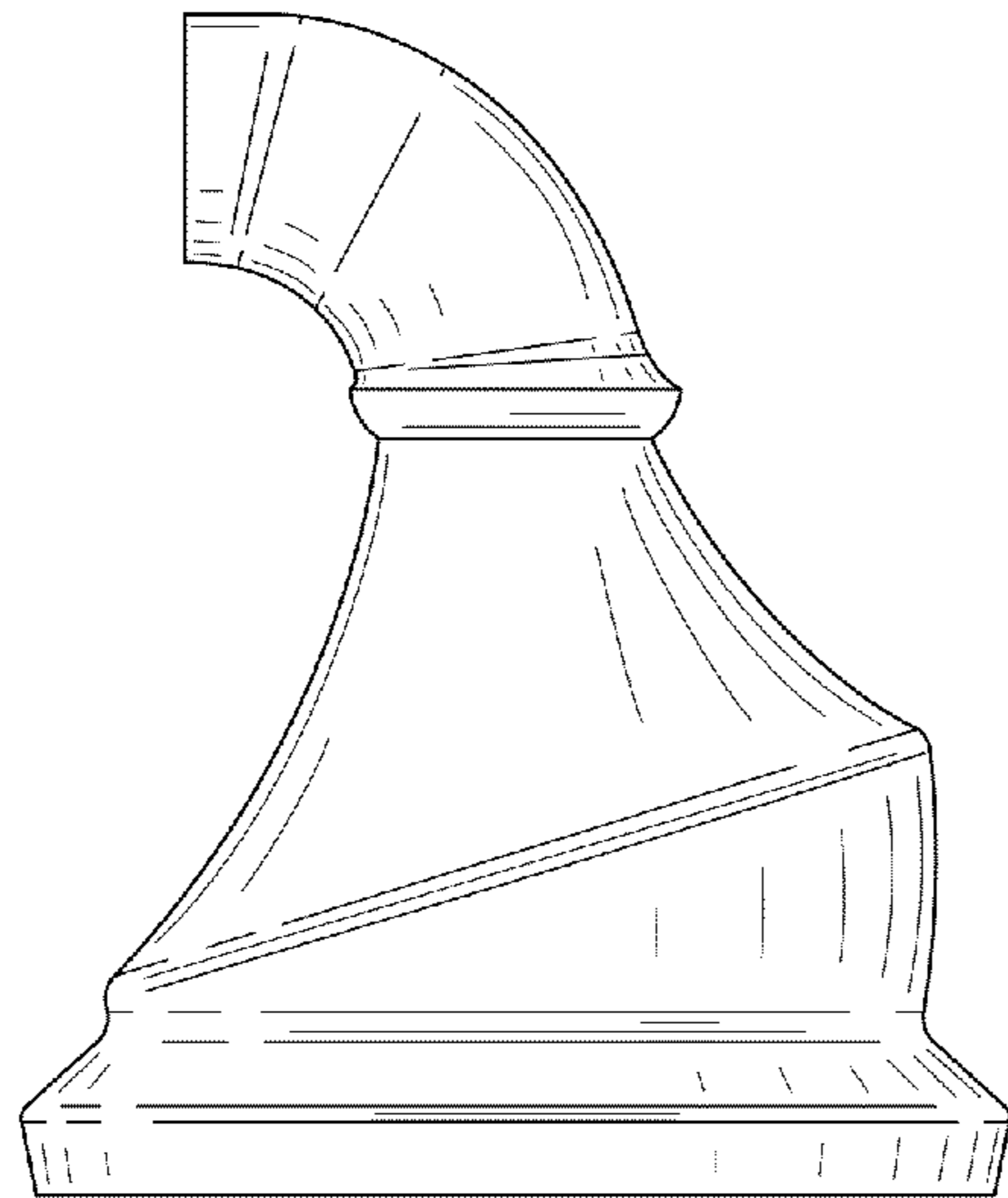

FIG. 12

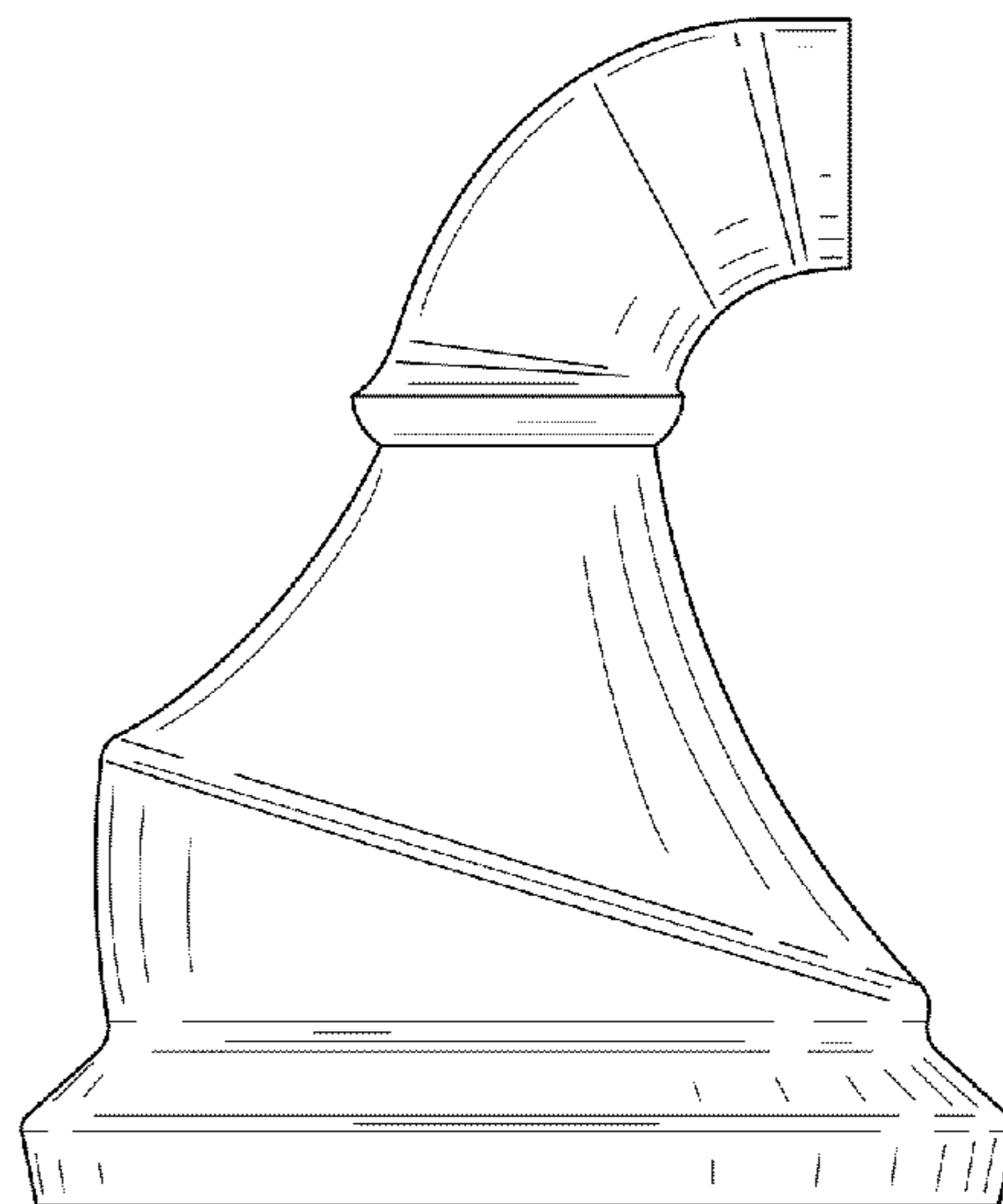

FIG. 13

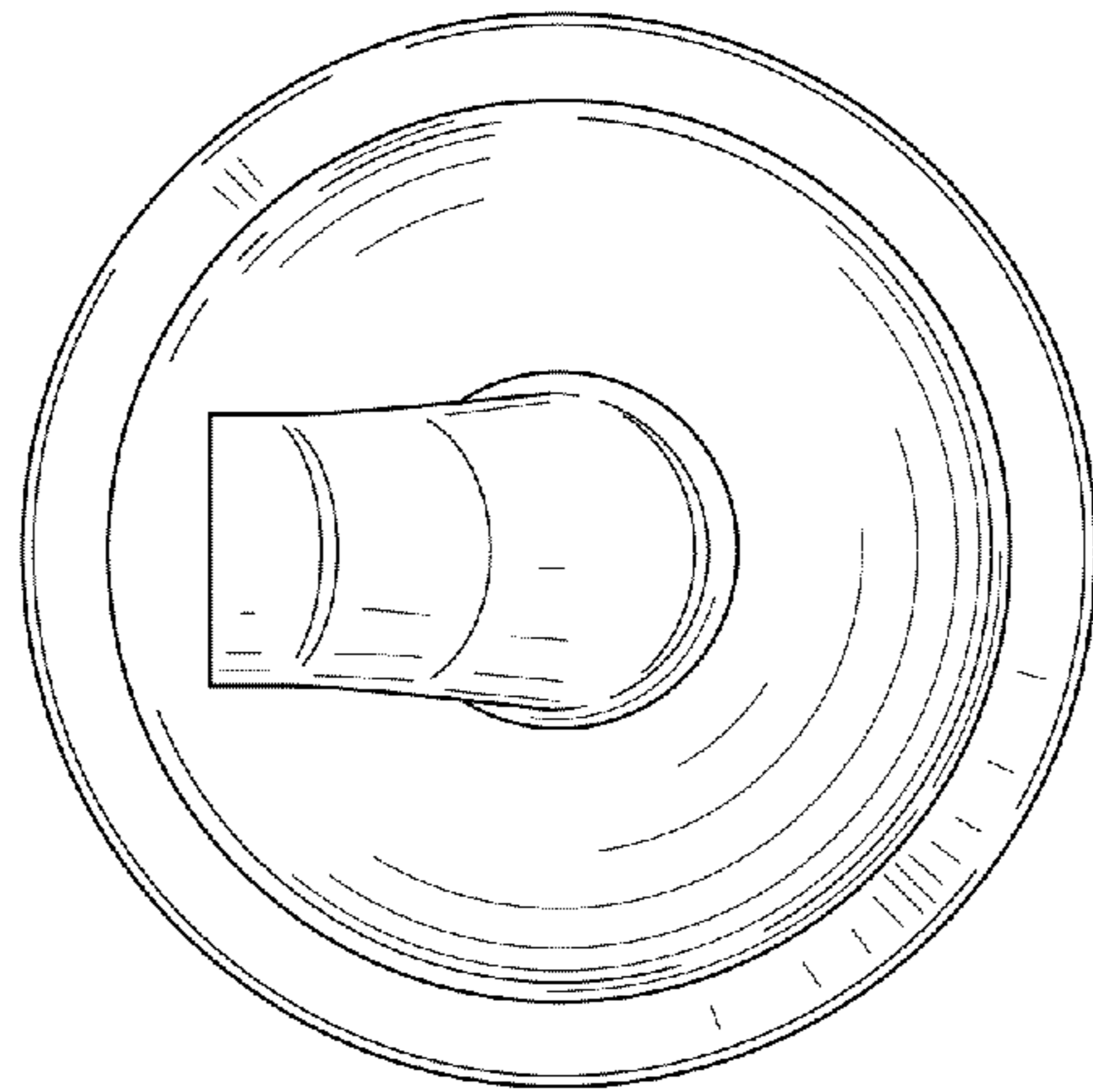

FIG. 14

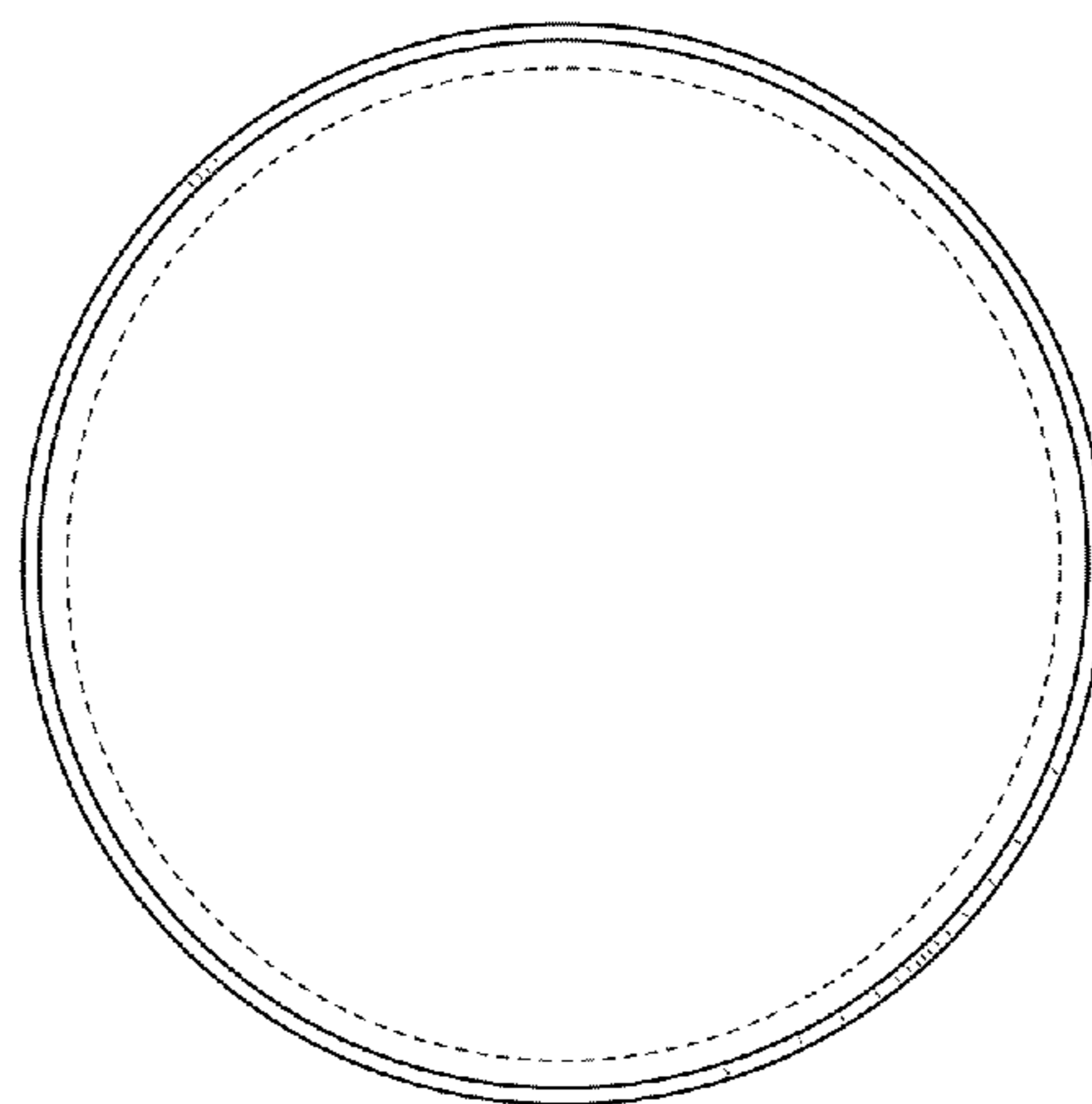

FIG. 15