



US00D668390S

(12) **United States Design Patent**
Hamazaki

(10) **Patent No.:** **US D668,390 S**

(45) **Date of Patent:** **** Oct. 2, 2012**

(54) **FALSE EYELASH**

(75) Inventor: **Masaaki Hamazaki**, Tokyo (JP)

(73) Assignee: **Hamazaki Co., Ltd.**, Tokyo (JP)

(**) Term: **14 Years**

(21) Appl. No.: **29/409,120**

(22) Filed: **Dec. 20, 2011**

(30) **Foreign Application Priority Data**

Jun. 20, 2011 (JP) 2011-13875

(51) **LOC (9) Cl.** **28-04**

(52) **U.S. Cl.** **D28/92**

(58) **Field of Classification Search** D28/39-43,
D28/92, 93; 132/53-56, 201

See application file for complete search history.

(56) **References Cited**

U.S. PATENT DOCUMENTS

- 3,516,422 A * 6/1970 Bechtold et al. 132/53
- 3,833,007 A * 9/1974 Jacobs 132/53
- 4,299,242 A * 11/1981 Choe 132/53

- D632,018 S * 2/2011 Nguyen D28/92
- D632,019 S * 2/2011 Nguyen D28/92
- 8,113,218 B2 * 2/2012 Nguyen 132/201
- 2010/0170526 A1 * 7/2010 Nguyen 132/201

FOREIGN PATENT DOCUMENTS

JP D1428765 11/2011

* cited by examiner

Primary Examiner — Zenia Bennett

(74) *Attorney, Agent, or Firm* — Arent Fox LLP

(57) **CLAIM**

The ornamental design for an false eyelash, as shown and described.

DESCRIPTION

FIG. 1 is a front view of a false eyelash showing my new design, a rear view is identical or a mirror image of the front view and is therefore omitted herefrom;

FIG. 2 is a top view of the design shown in FIG. 1;

FIG. 3 is a bottom view of the design shown in FIG. 1;

FIG. 4 is a left side view of the design shown in FIG. 1;

FIG. 5 is a right side view of the design shown in FIG. 1; and,

FIG. 6 is a cross-sectional view of the design shown in FIG. 1 according to line A-A indicating the contour of the exterior surface of the claimed design.

1 Claim, 1 Drawing Sheet

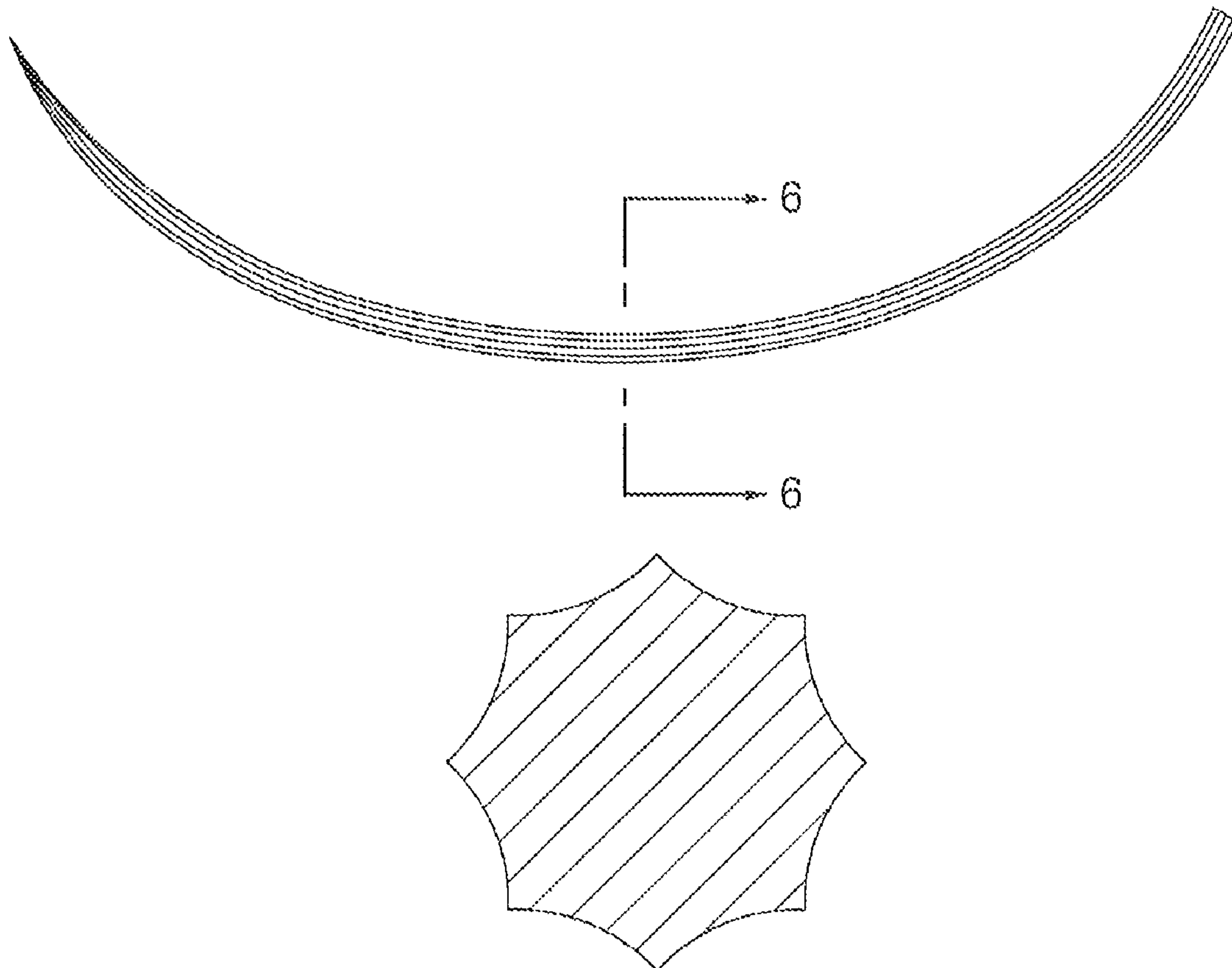

FIG. 1

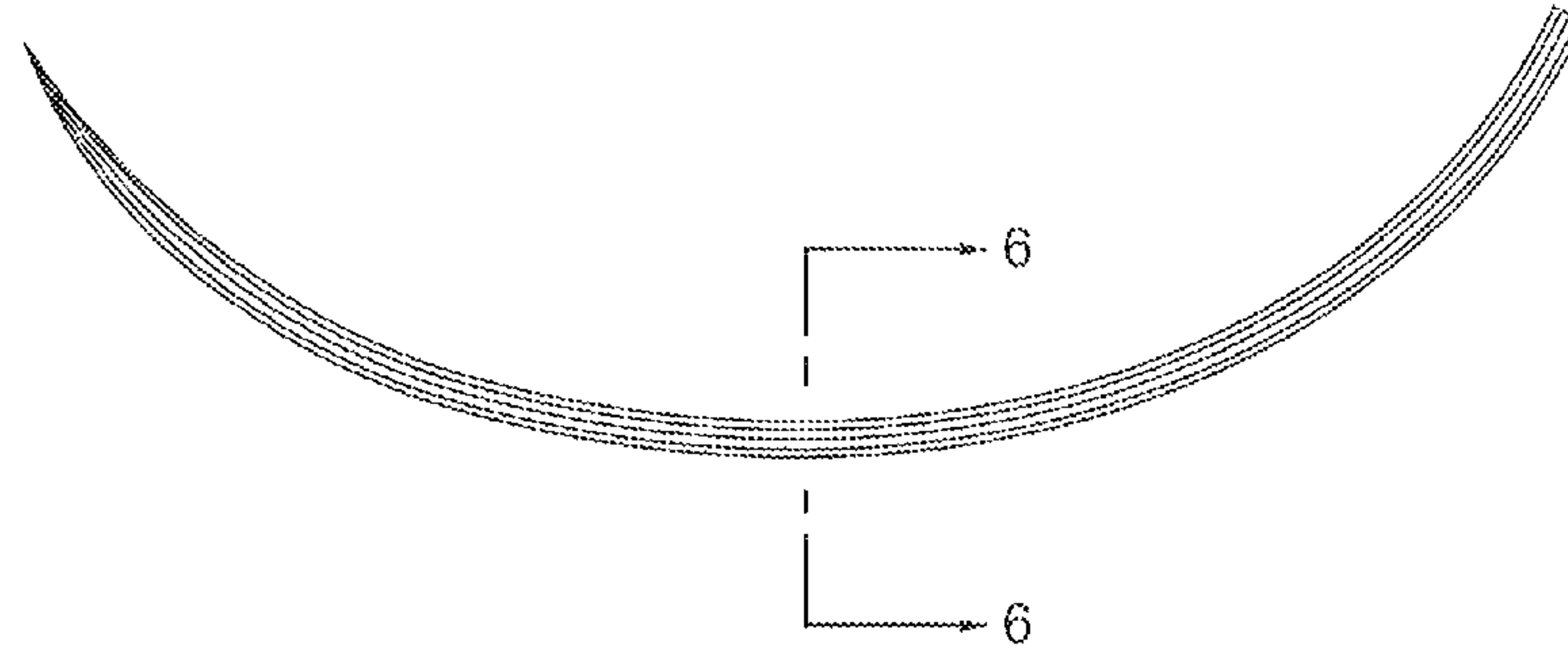

FIG. 2

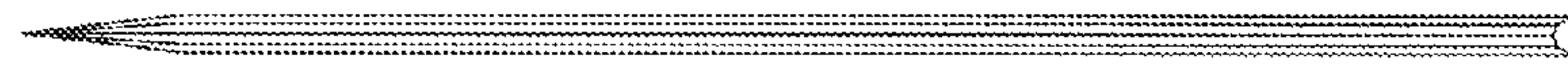

FIG. 3

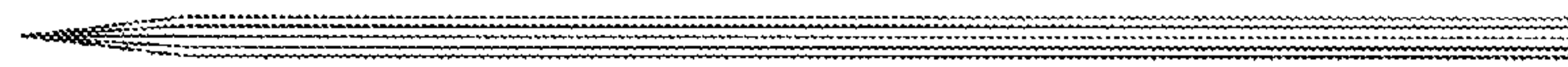

FIG. 4



FIG. 5

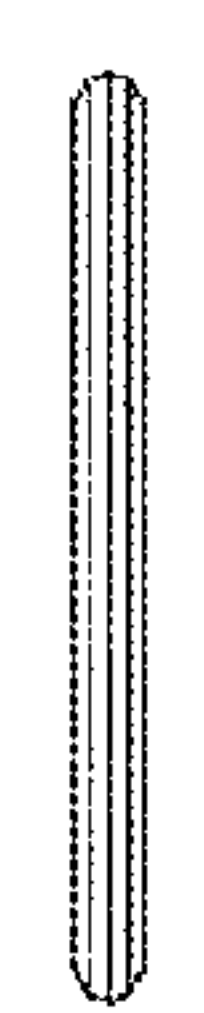
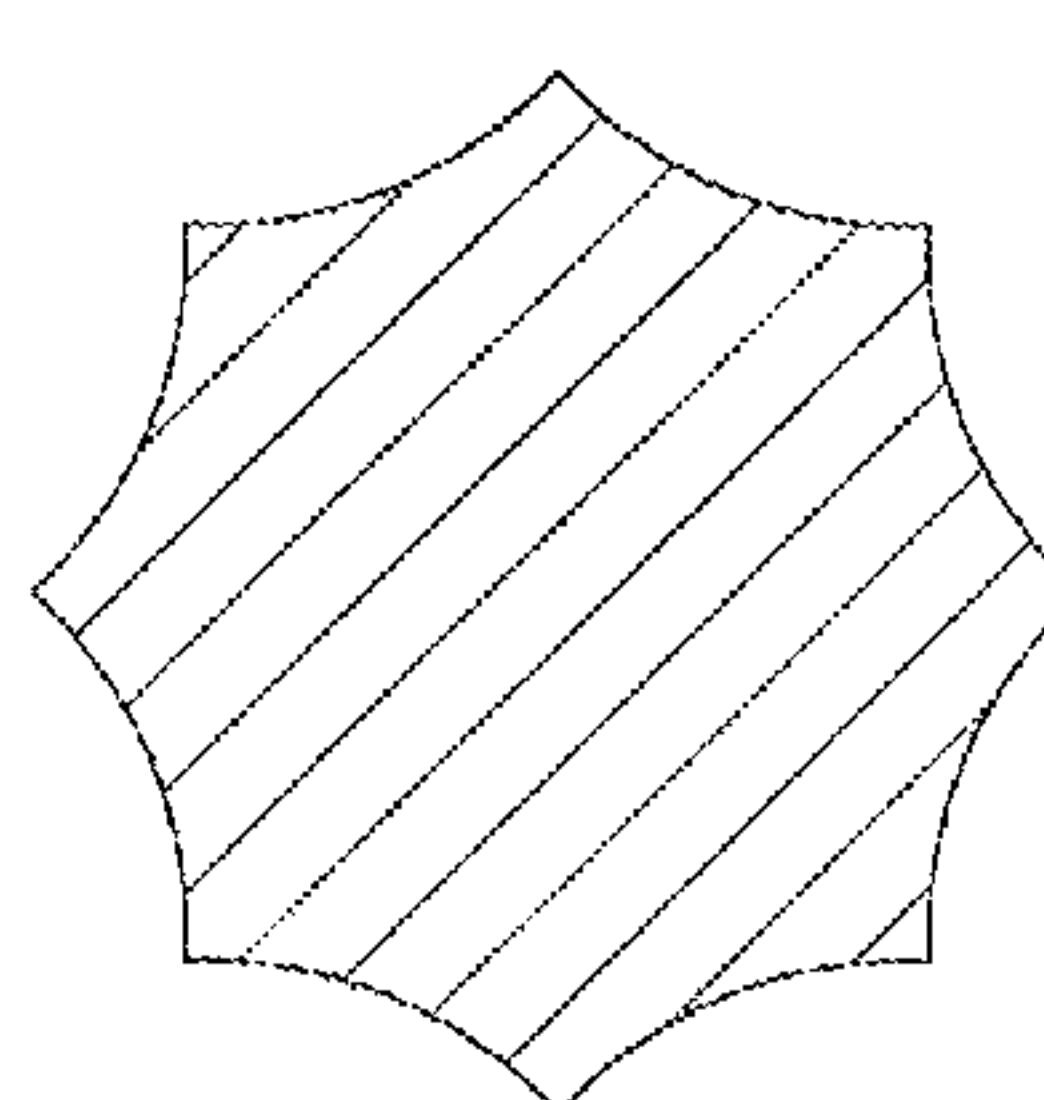

FIG. 6



UNITED STATES PATENT AND TRADEMARK OFFICE
CERTIFICATE OF CORRECTION

PATENT NO. : D668,390 S
APPLICATION NO. : 29/409120
DATED : October 2, 2012
INVENTOR(S) : Masaaki Hamazaki

Page 1 of 1

It is certified that error appears in the above-identified patent and that said Letters Patent is hereby corrected as shown below:

Title Page,

In the Description of the Drawings -

Please delete the description of FIG. 6 in its entirety and substitute therefor

-- FIG. 6 is a cross-sectional view of the design shown in FIG. 1, according to line 6-6 indicating the contour of the exterior surface of the claimed design. --

Signed and Sealed this
Twenty-fifth Day of December, 2012

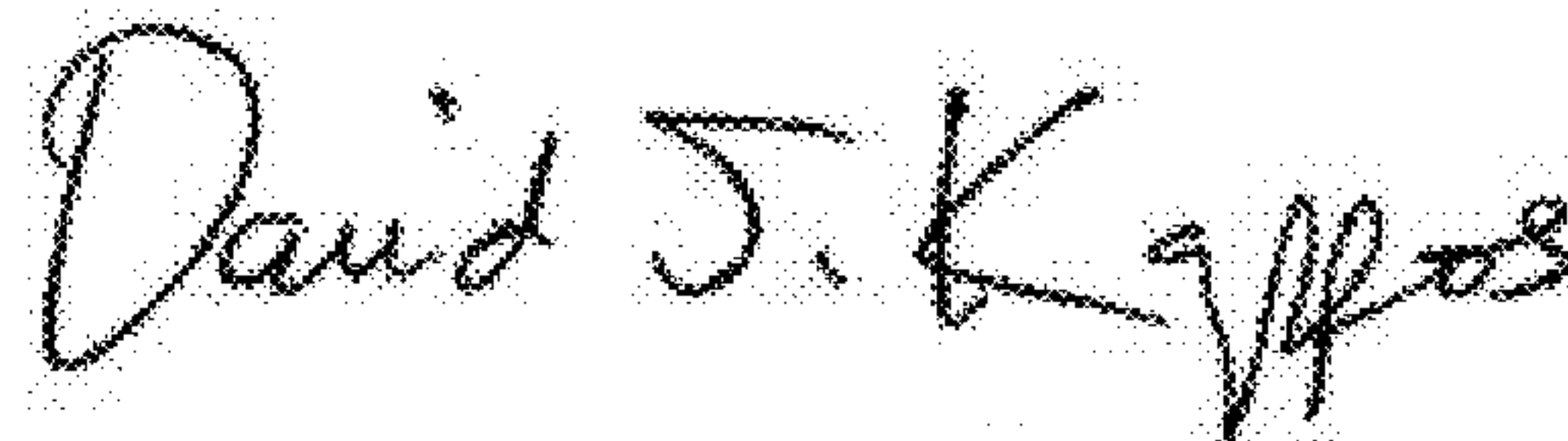
A handwritten signature in black ink that reads "David J. Kappos". The signature is written in a cursive, slightly slanted style.

David J. Kappos
Director of the United States Patent and Trademark Office