



US00D668373S

(12) **United States Design Patent**
Martin

(10) **Patent No.:** **US D668,373 S**

(45) **Date of Patent:** **** Oct. 2, 2012**

(54) **LAMP**

(75) Inventor: **David Martin**, Brandon, VT (US)

(73) Assignee: **Hubbardton Forge, LLC**, Castleton, VT (US)

(**) Term: **14 Years**

(21) Appl. No.: **29/410,450**

(22) Filed: **Jan. 9, 2012**

(51) **LOC (9) Cl.** **26-03**

(52) **U.S. Cl.** **D26/88; D26/128**

(58) **Field of Classification Search** D26/80,
D26/83, 84, 86, 88-90, 124, 128, 131, 135;
362/147, 404-408

See application file for complete search history.

(56) **References Cited**

U.S. PATENT DOCUMENTS

D43,646	S	*	2/1913	Ryan	D26/88
D51,021	S	*	7/1917	Mohr	D26/90
D80,418	S	*	1/1930	Hoch	D26/91
D191,627	S	*	10/1961	Heckman	D26/136
D197,379	S	*	1/1964	Rentz	D26/128
D251,630	S	*	4/1979	Larson	D26/128
D302,048	S	*	7/1989	Dolfi	D26/103
D482,818	S	*	11/2003	Vegliante	D26/128
D596,779	S	*	7/2009	Silver	D26/88
D641,919	S	*	7/2011	Parker et al.	D26/118
D643,967	S	*	8/2011	Sernotte et al.	D26/88

* cited by examiner

Primary Examiner — Clare E Heflin

(74) *Attorney, Agent, or Firm* — Bourque and Associates, PA

(57) **CLAIM**

The ornamental design for a lamp, as shown and described.

DESCRIPTION

FIG. 1 is a perspective view of the lamp according to the present invention;
 FIG. 2 is a front view of the lamp thereof;
 FIG. 3 is a back view of the lamp thereof;
 FIG. 4 is a left view of the lamp thereof;
 FIG. 5 is a right view of the lamp thereof;
 FIG. 6 is a top view of the lamp thereof;
 FIG. 7 is a bottom view of the lamp thereof;
 FIG. 8 is a perspective view of the lamp according to a second embodiment of the present invention;
 FIG. 9 is a front view thereof;
 FIG. 10 is a back view thereof;
 FIG. 11 is a left view of the lamp thereof;
 FIG. 12 is a right view thereof;
 FIG. 13 is a top view thereof; and,
 FIG. 14 is a bottom view thereof.

The broken lines shown on the drawings depict portions of the <light fixture> that form no part of the claimed design.

1 Claim, 14 Drawing Sheets



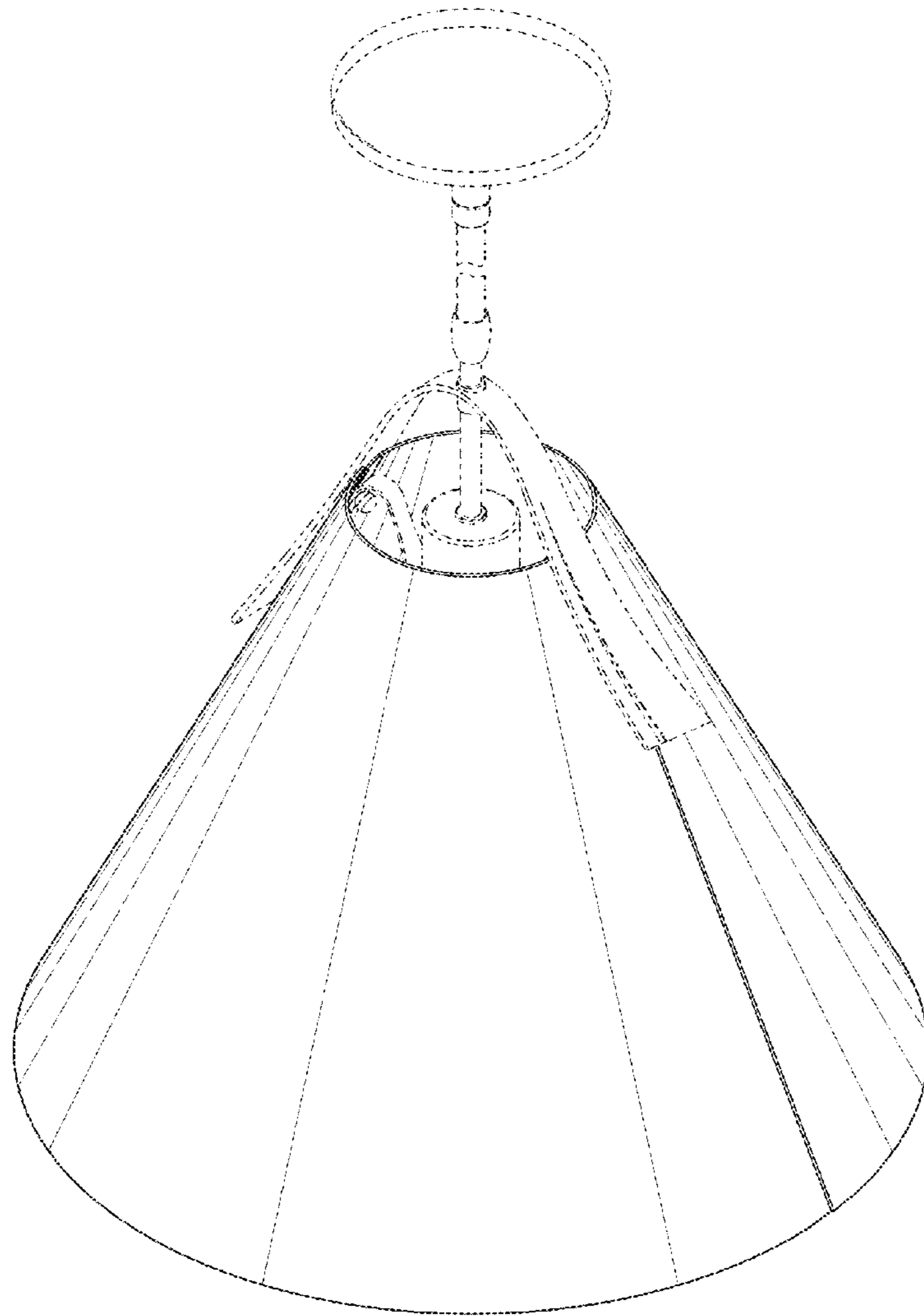

FIG. 1

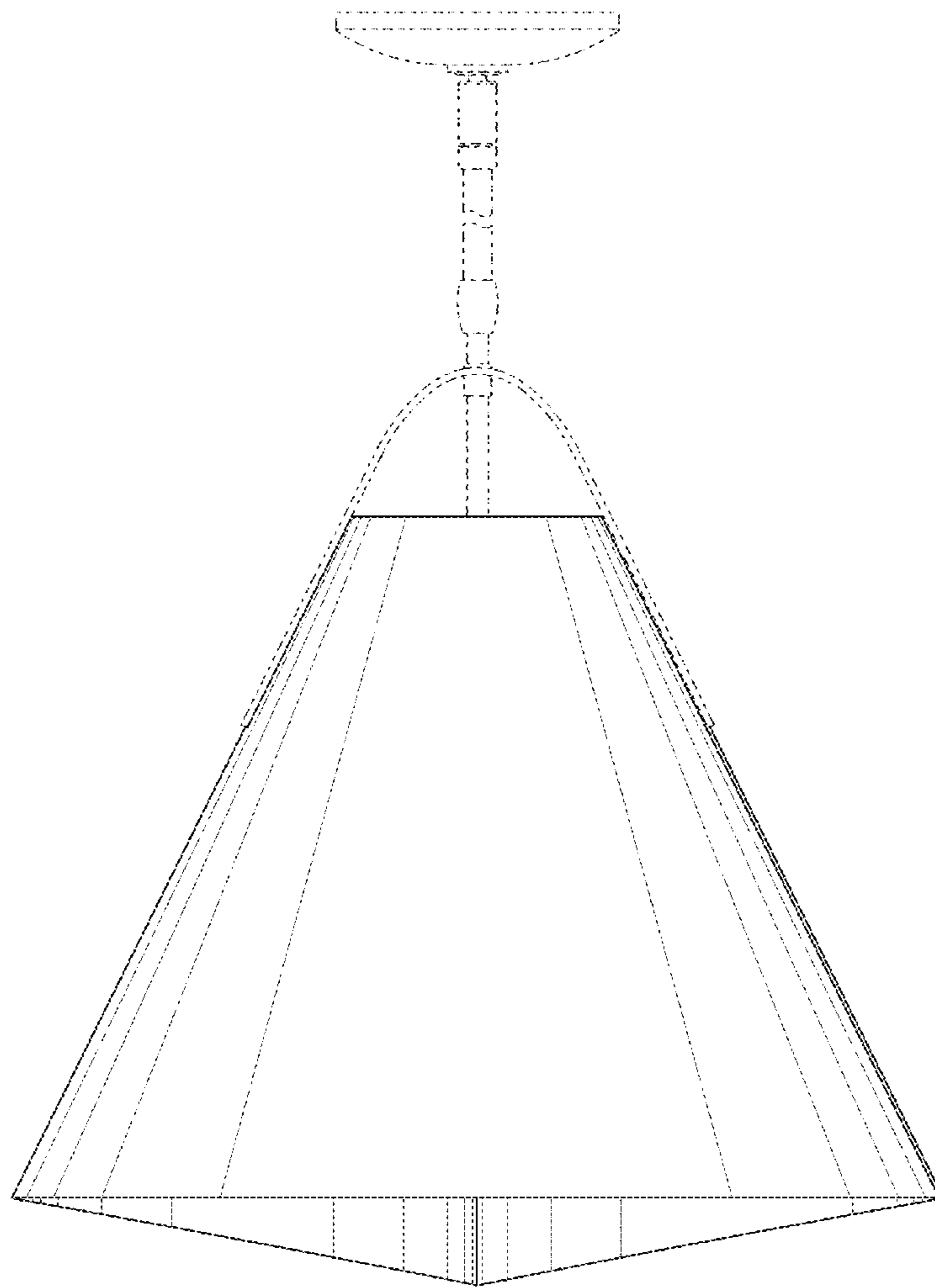

FIG. 2

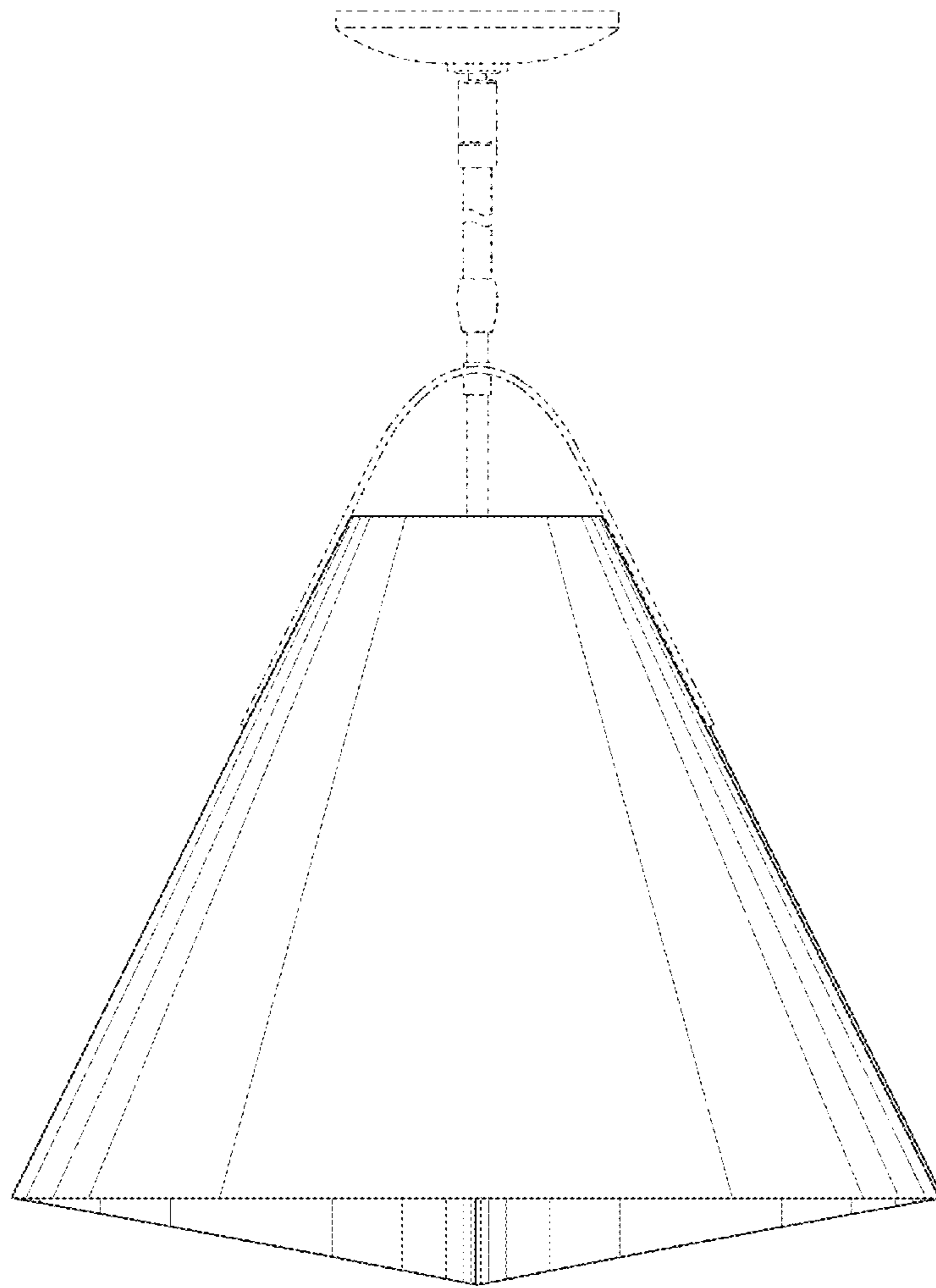

FIG. 3

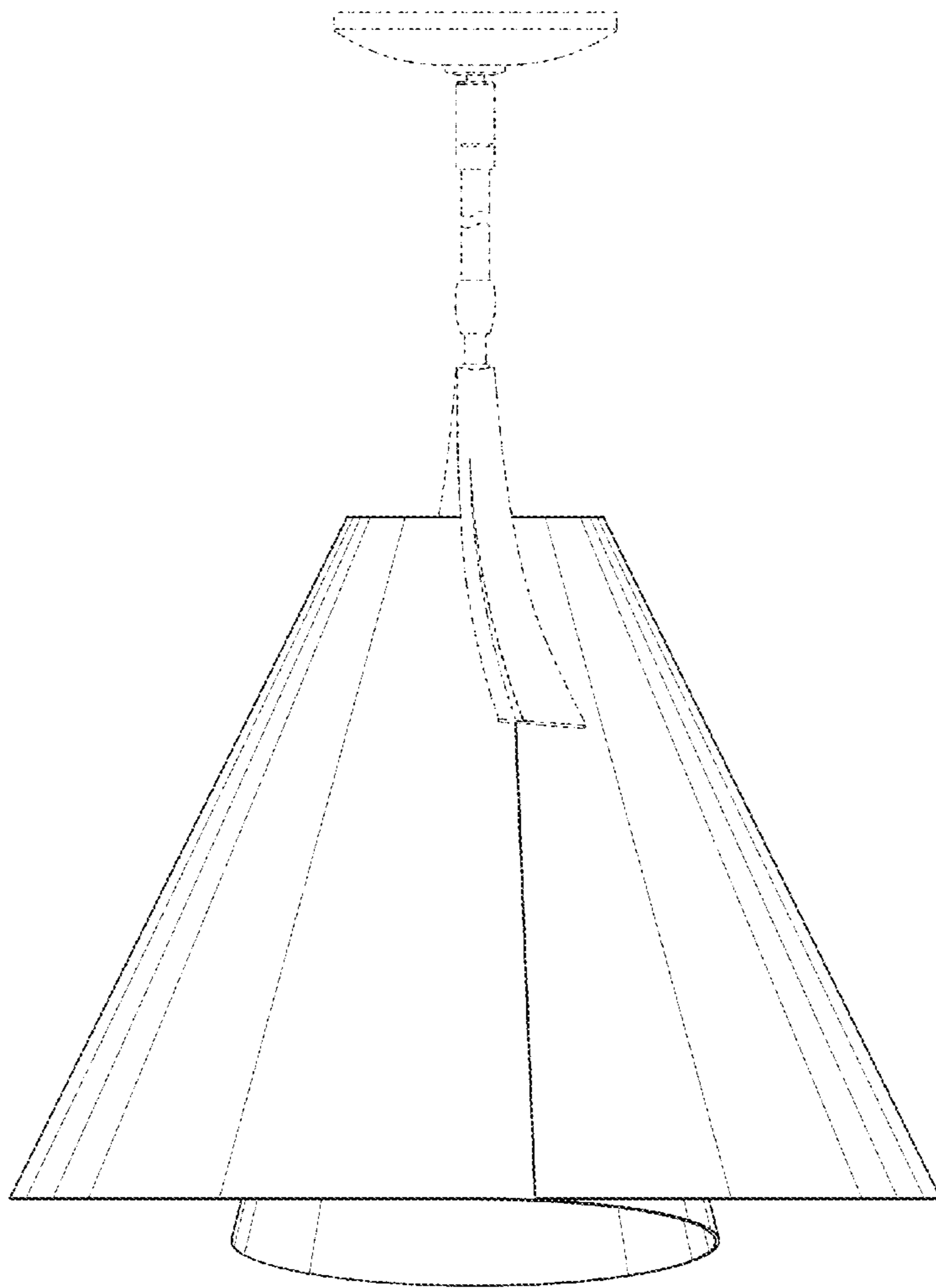

FIG. 4

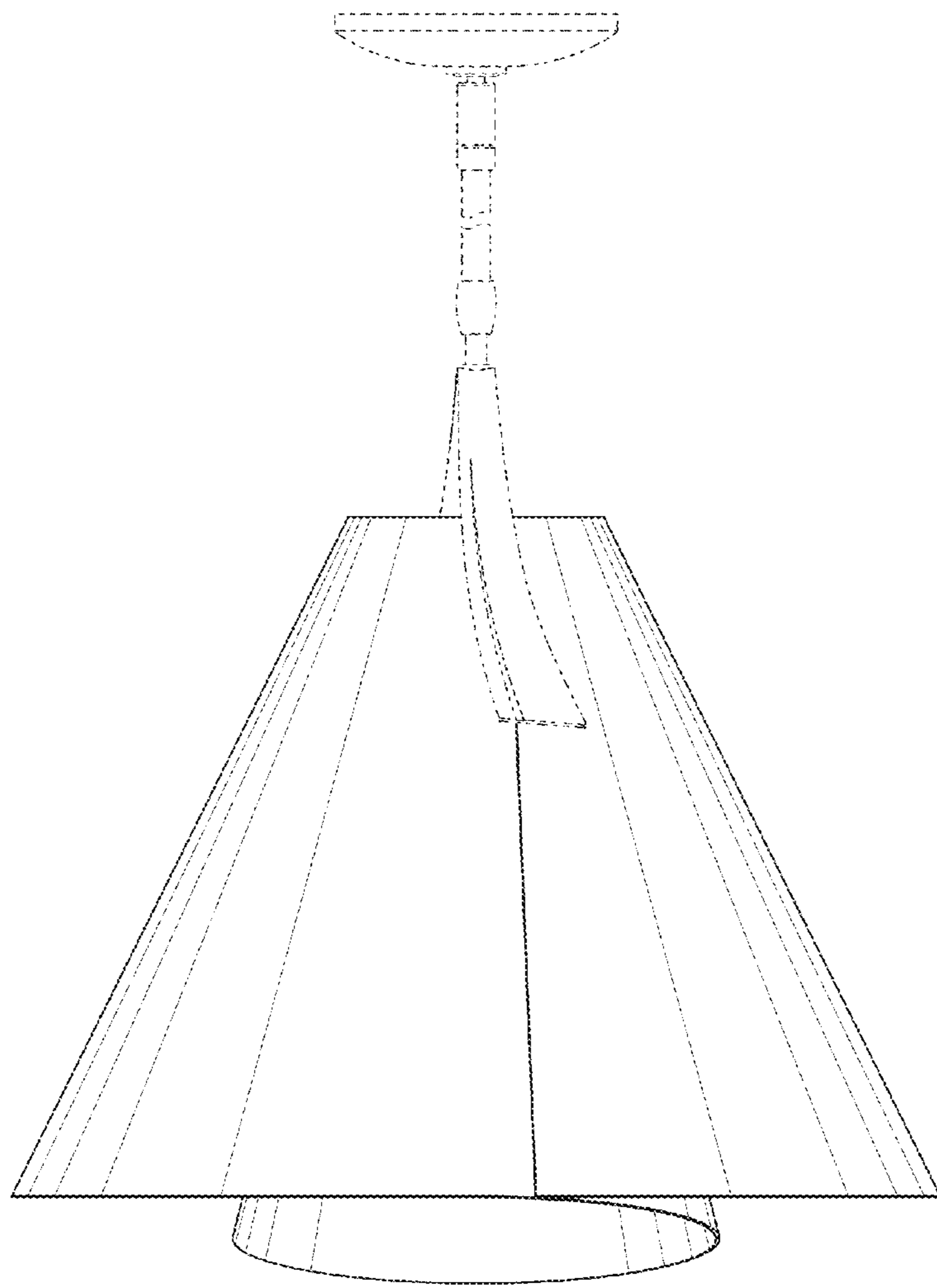

FIG. 5

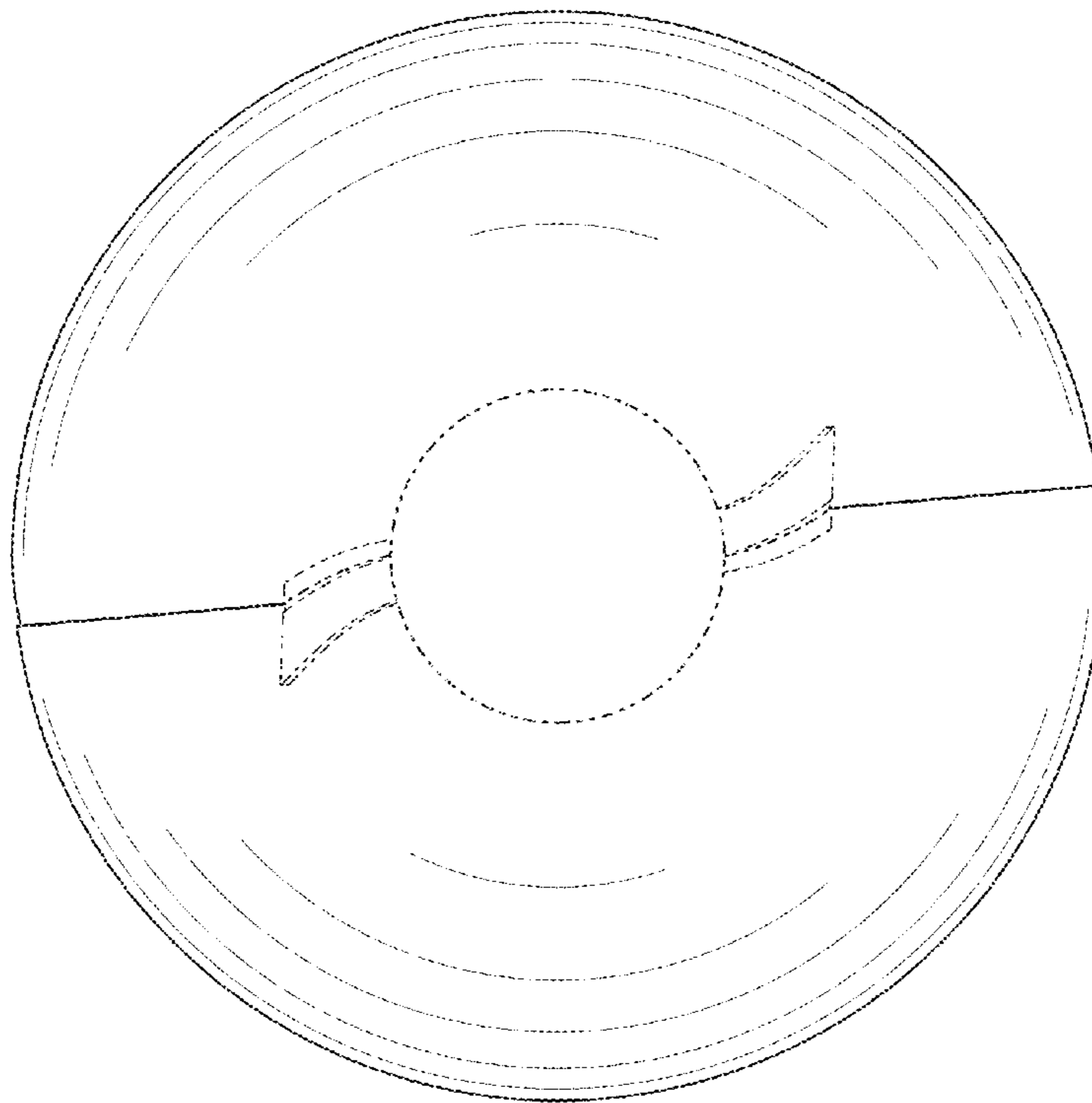

FIG. 6

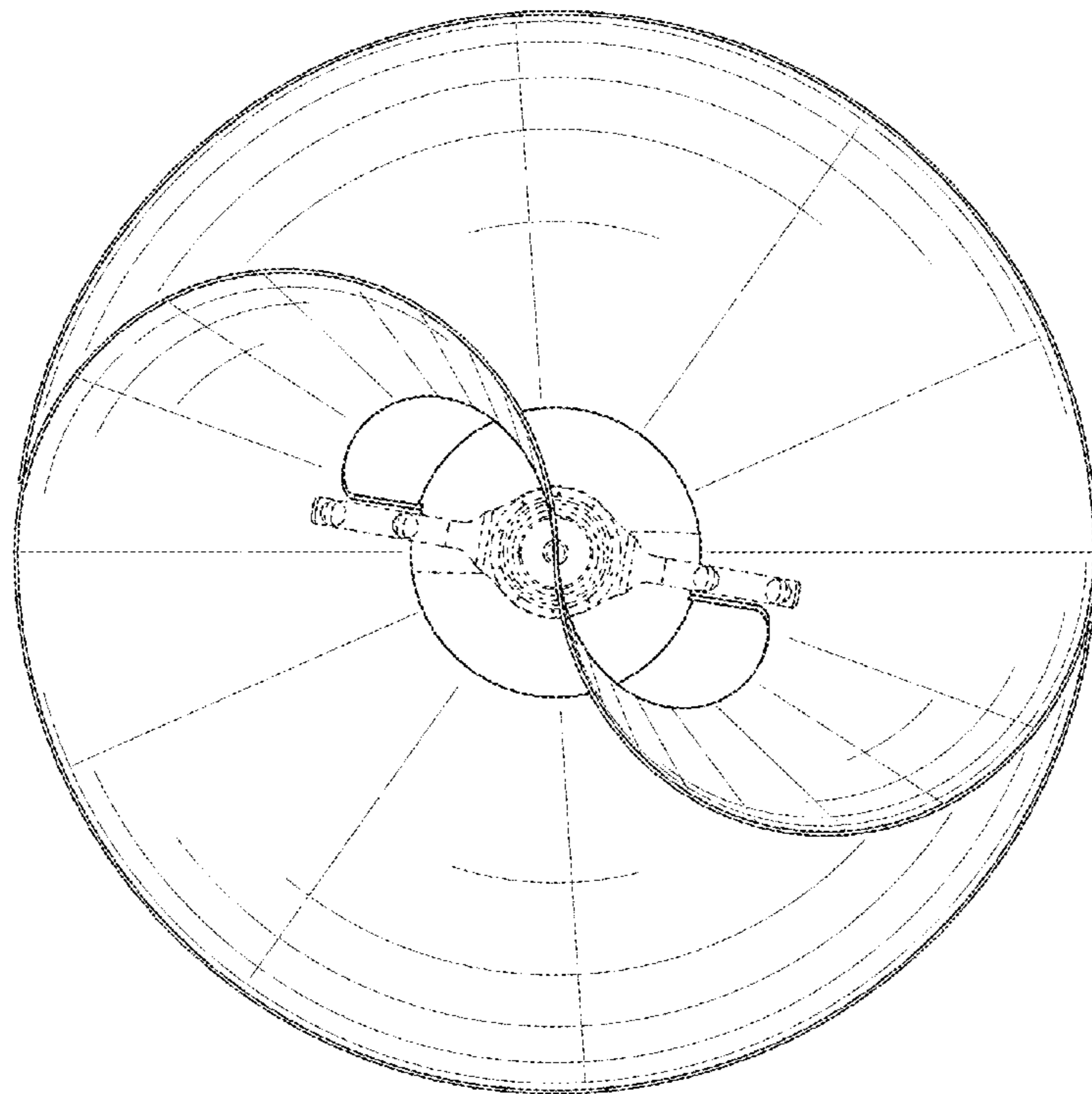

FIG. 7

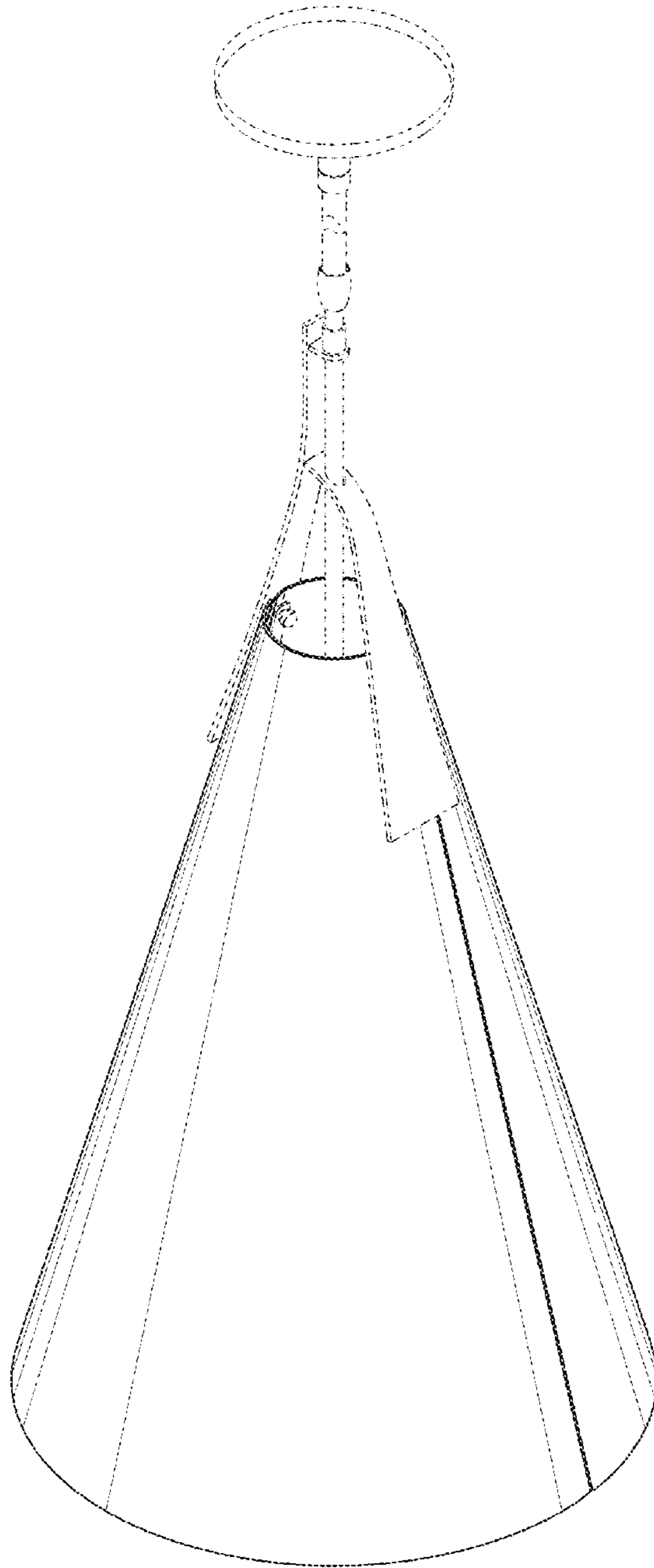

FIG. 8

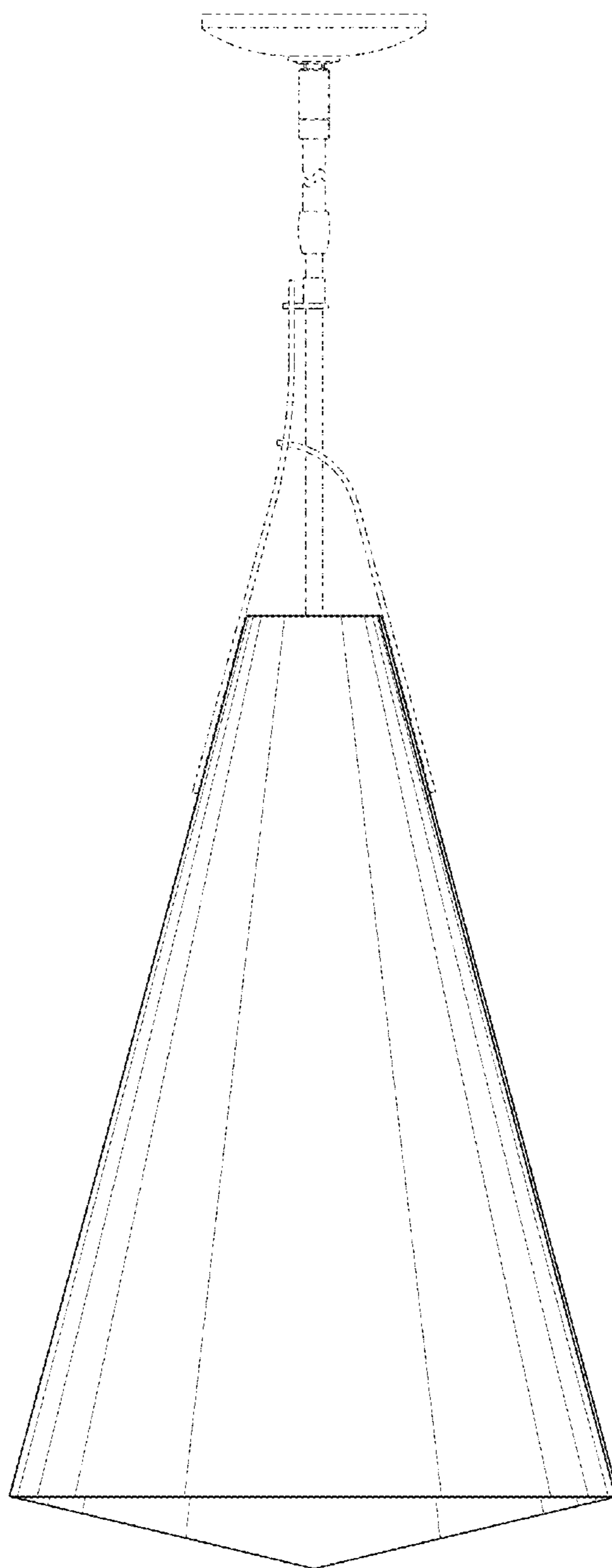

FIG. 9

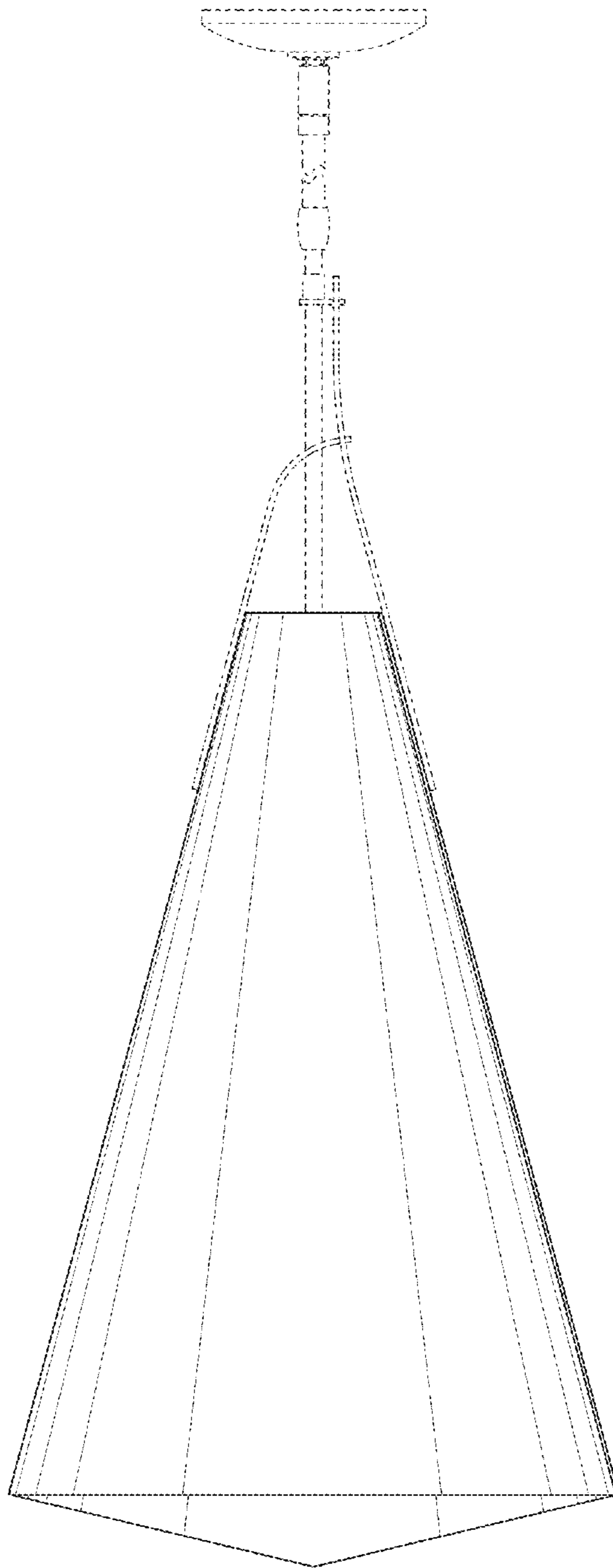

FIG. 10

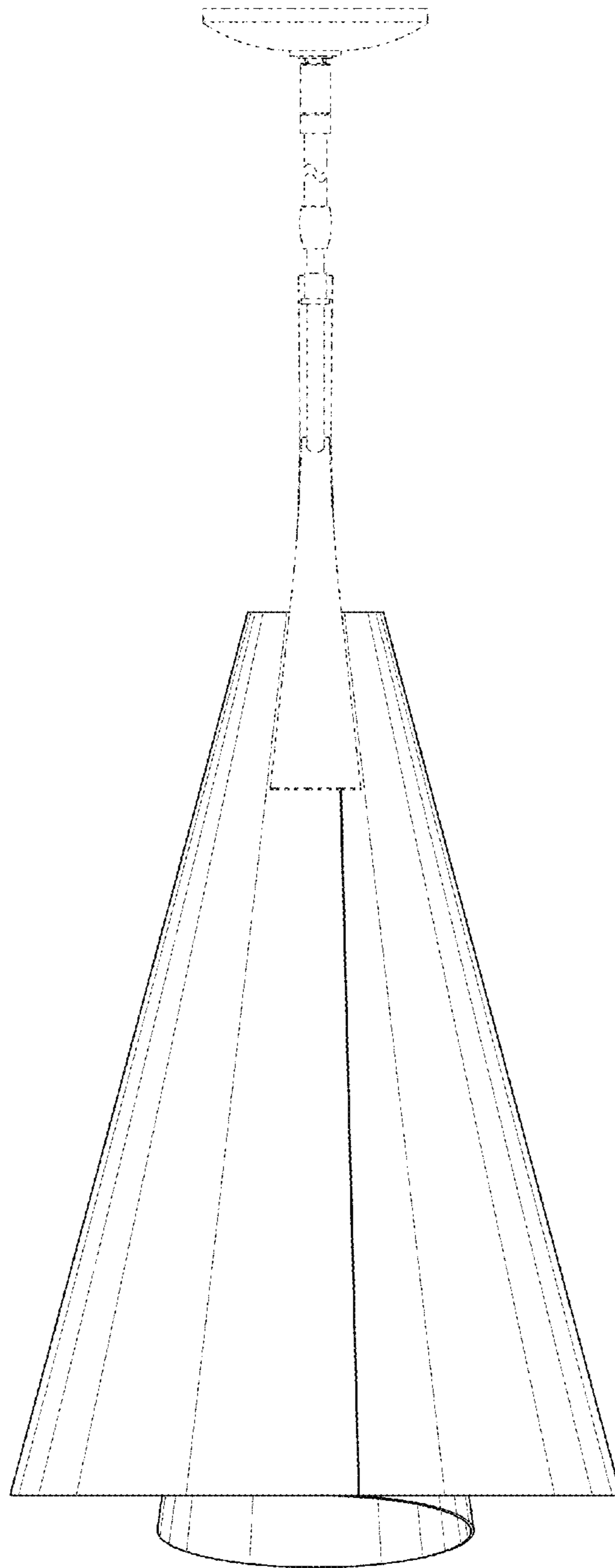

FIG. 11

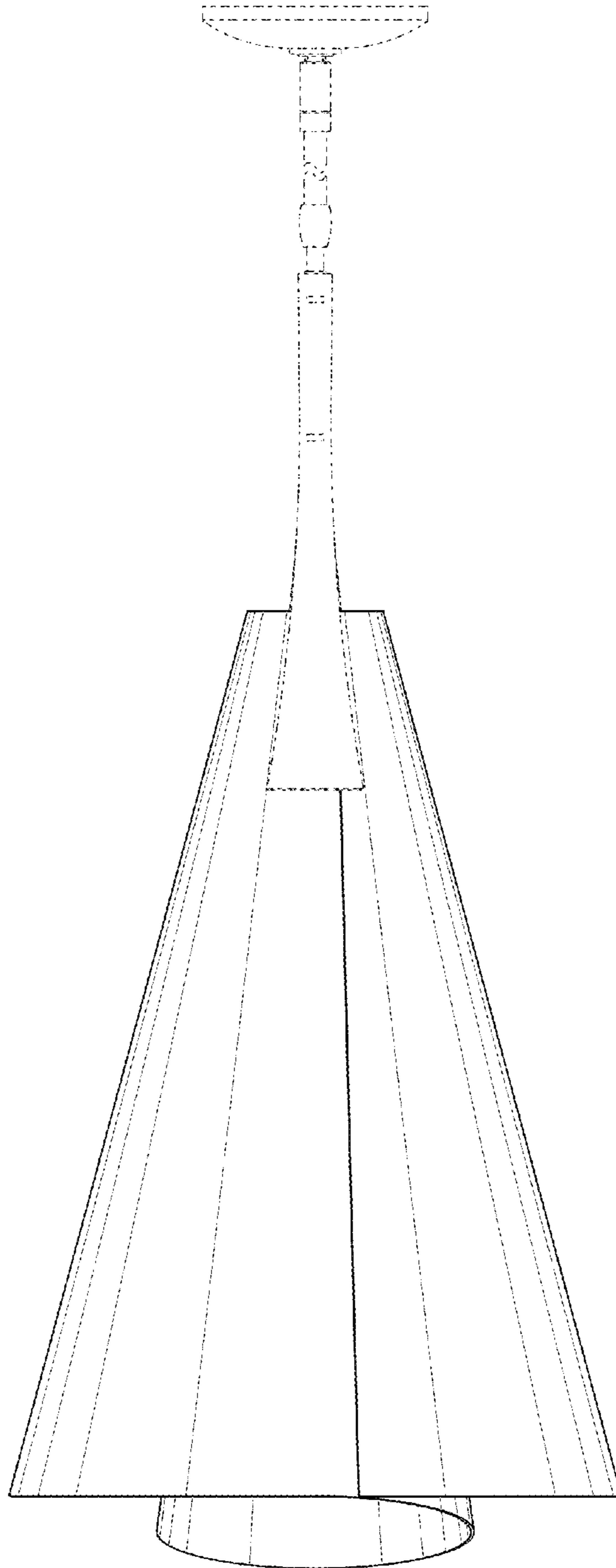

FIG. 12

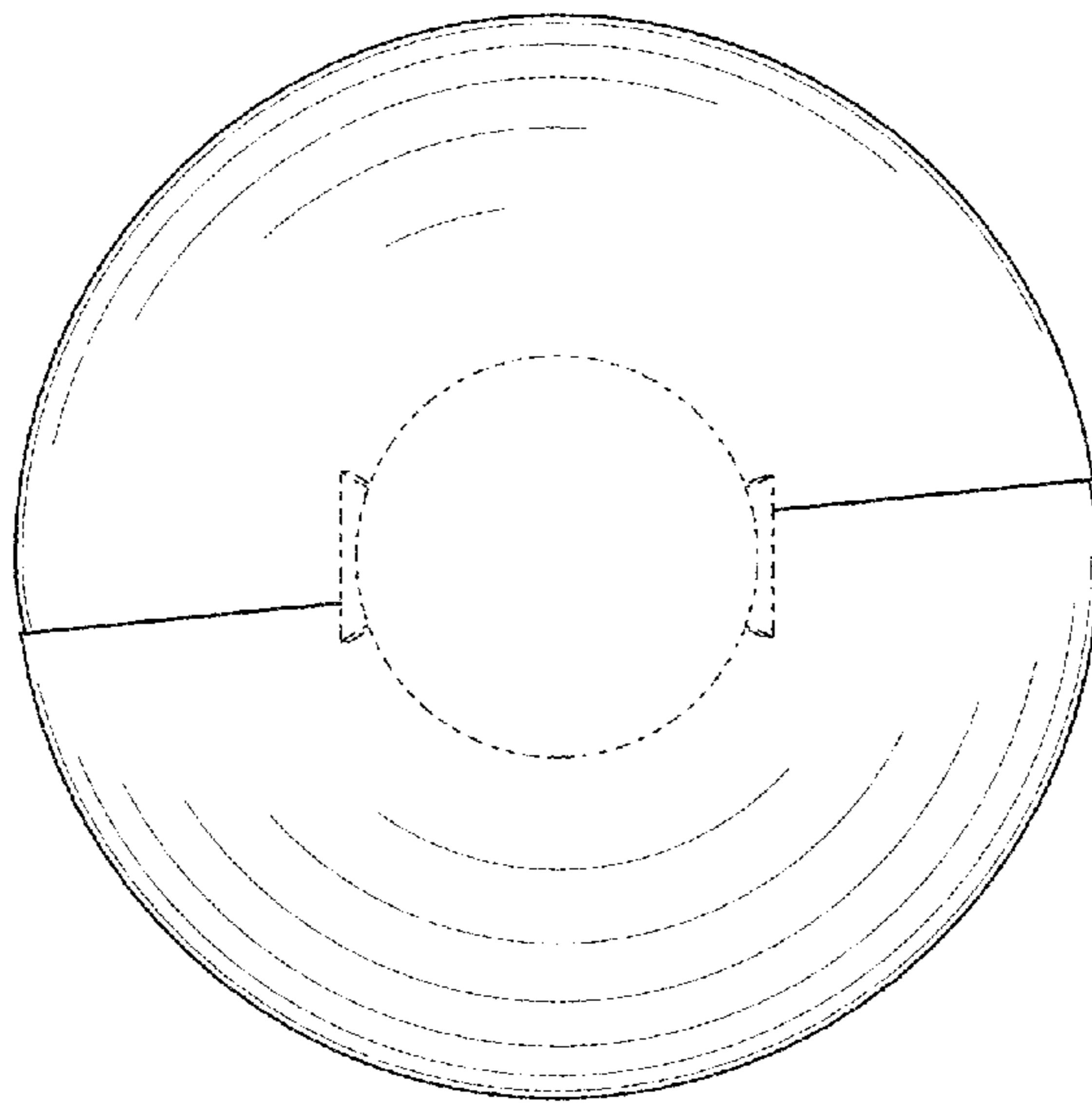

FIG. 13

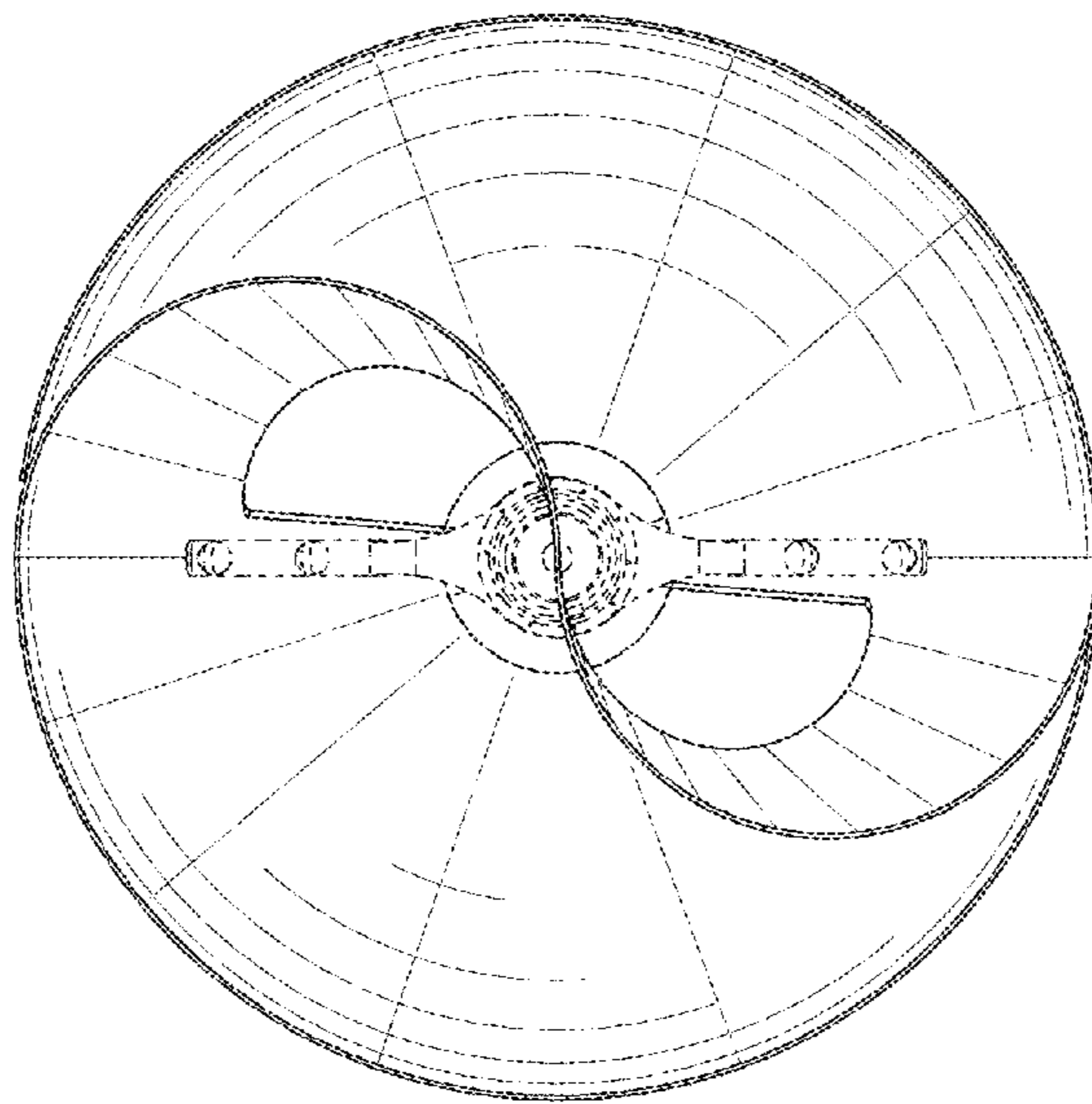

FIG. 14