



US00D668337S

(12) **United States Design Patent**
Schürg

(10) **Patent No.:** **US D668,337 S**

(45) **Date of Patent:** **** Oct. 2, 2012**

(54) **ELECTRO-SURGICAL CLAMP AND CUTTING DEVICE**

(75) Inventor: **Peter Schürg**, Mössingen (DE)

(73) Assignee: **Erbe Elektromedizin GmbH**, Tübingen (DE)

(**) Term: **14 Years**

(21) Appl. No.: **29/391,860**

(22) Filed: **May 13, 2011**

(30) **Foreign Application Priority Data**

Nov. 15, 2010 (EM) 001781212

(51) **LOC (9) Cl.** **24-02**

(52) **U.S. Cl.** **D24/144; 24/146**

(58) **Field of Classification Search** D24/133,
D24/143-146, 148-149; 600/564; 604/22;
606/41-42, 51-52, 48, 169-171, 205-208

See application file for complete search history.

(56) **References Cited**

U.S. PATENT DOCUMENTS

5,330,471	A *	7/1994	Eggers	606/48
5,716,366	A *	2/1998	Yates	606/45
5,873,873	A *	2/1999	Smith et al.	606/169
5,944,737	A *	8/1999	Tsonton et al.	606/205
5,947,996	A *	9/1999	Logeman	606/205
5,954,736	A *	9/1999	Bishop et al.	606/157
6,682,544	B2 *	1/2004	Mastri et al.	606/169
2002/0107517	A1 *	8/2002	Witt et al.	606/50
2010/0063525	A1 *	3/2010	Beaupre et al.	606/169

2010/0324551	A1 *	12/2010	Gerhardt	606/41
2011/0213397	A1 *	9/2011	Mathonnet	606/169
2011/0230910	A1 *	9/2011	Stopek et al.	606/205

* cited by examiner

Primary Examiner — Wan Laymon

(74) *Attorney, Agent, or Firm* — Dickstein Shapiro LLP

(57) **CLAIM**

The ornamental design for a electro-surgical clamp and cutting device, as shown and described.

DESCRIPTION

FIG. 1 is a right side view of a first embodiment of a electro-surgical clamp and cutting device, showing the new design; FIG. 2 is a left side view thereof;

FIG. 3 is a front view thereof;

FIG. 4 is a rear view thereof;

FIG. 5 is a top view thereof;

FIG. 6 is a bottom view thereof;

FIG. 7 is a perspective view thereof;

FIG. 8 is a right side view of a second embodiment of a electro-surgical clamp and cutting device, showing the new design;

FIG. 9 is a left side view thereof;

FIG. 10 is a front view thereof;

FIG. 11 is a rear view thereof;

FIG. 12 is a top view thereof;

FIG. 13 is a bottom view thereof; and,

FIG. 14 is a perspective view thereof.

The broken lines in the drawings represent unclaimed environmental subject matter. The broken away symbols in the drawings indicate that any portion of the article beyond what is shown forms no part of the claimed design.

1 Claim, 10 Drawing Sheets

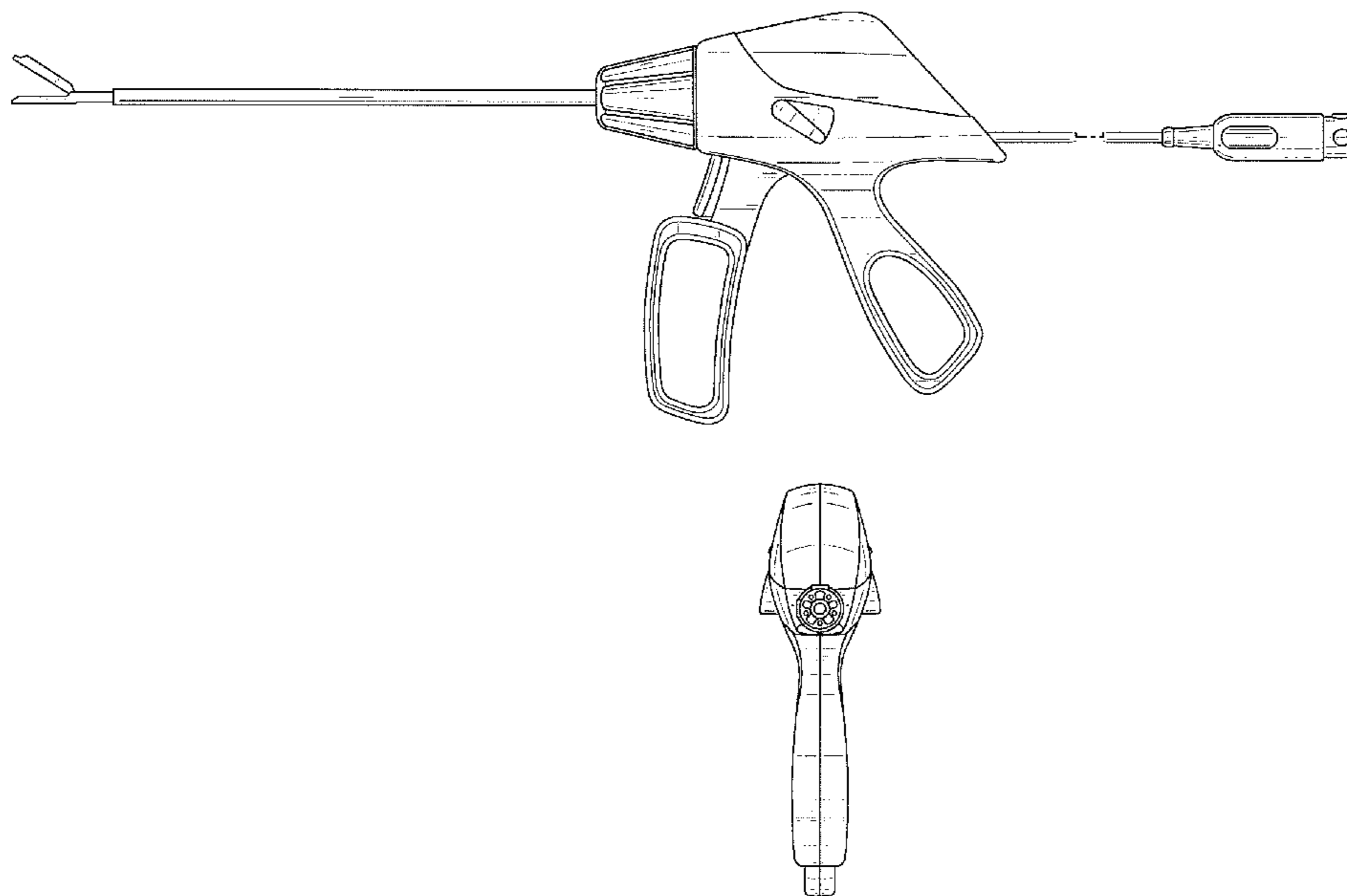

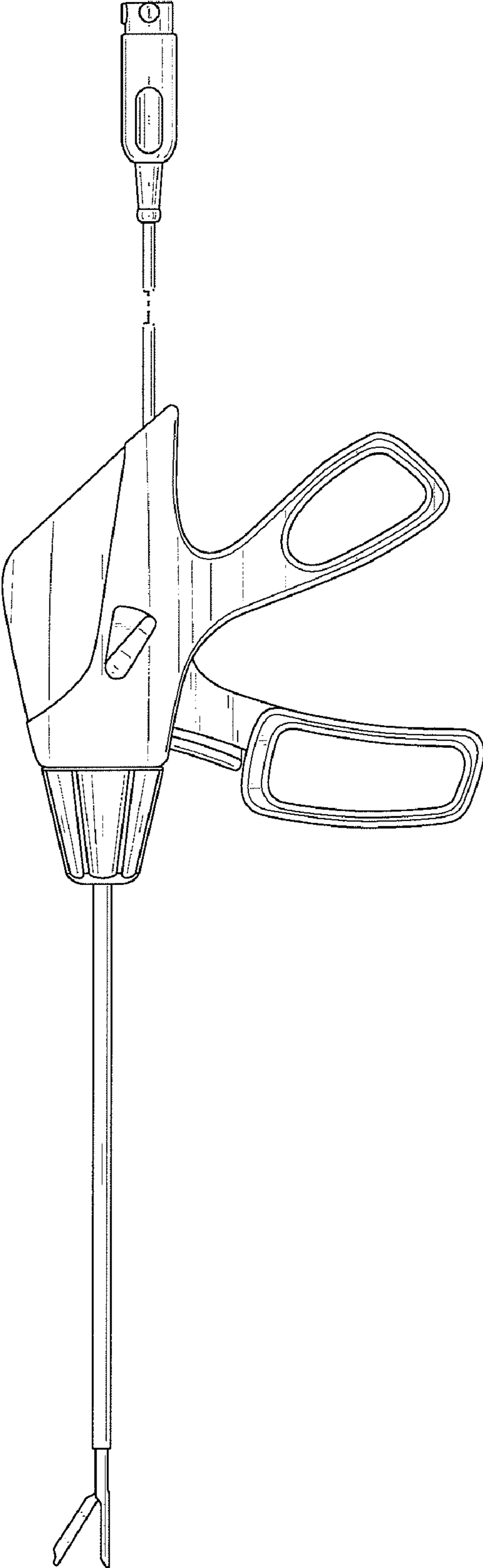

FIG. 1

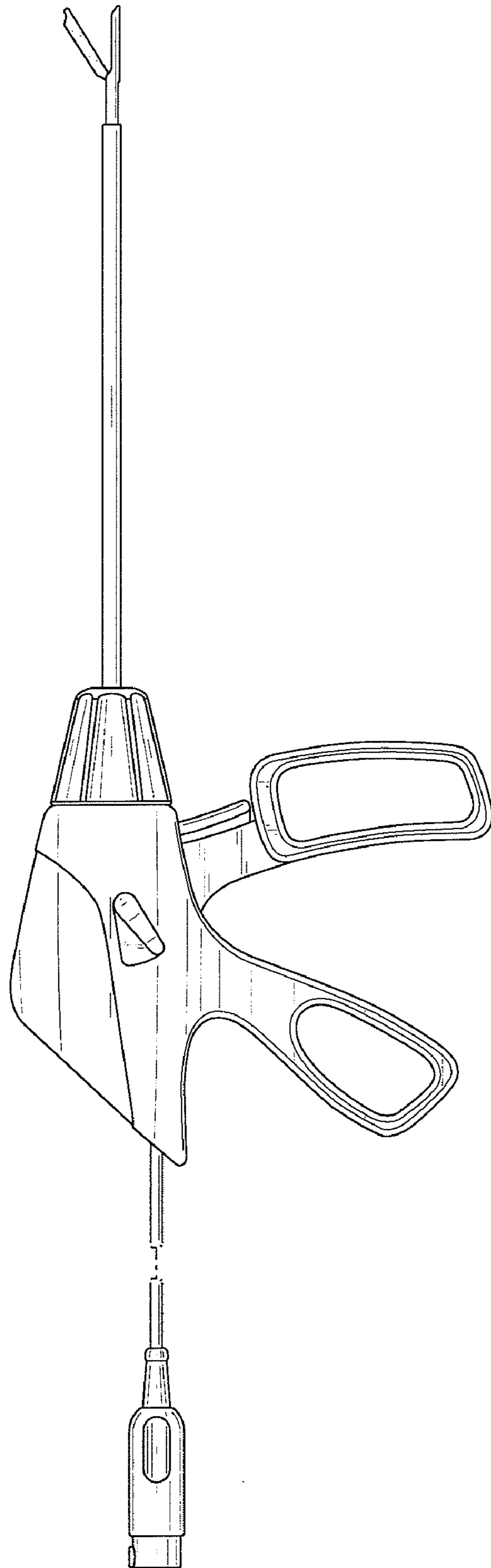

FIG. 2

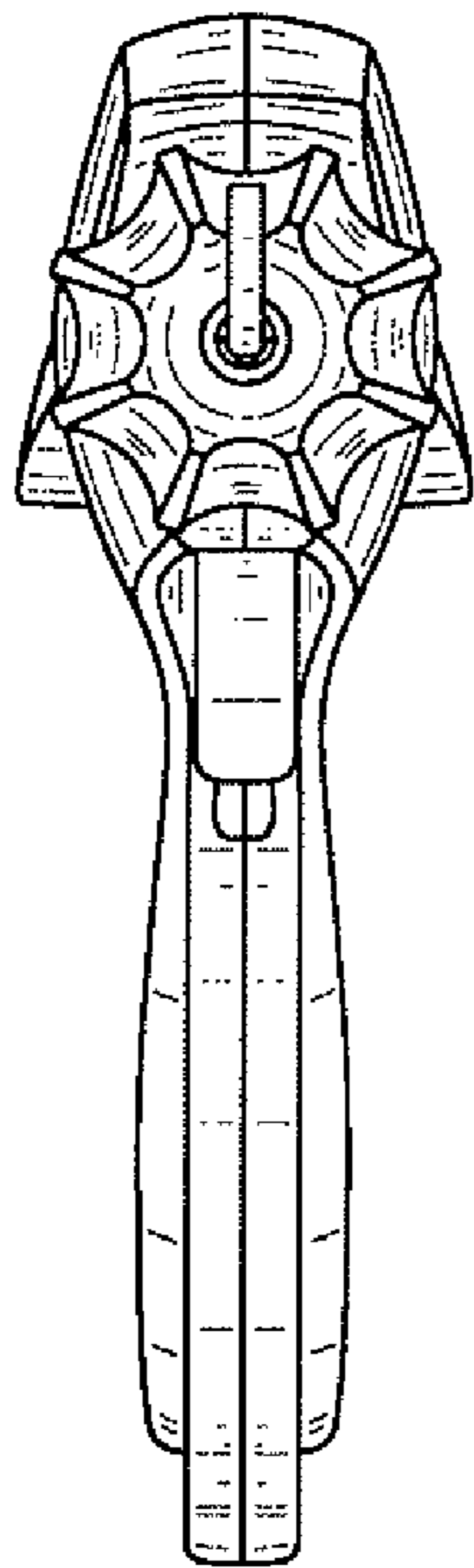

FIG. 3

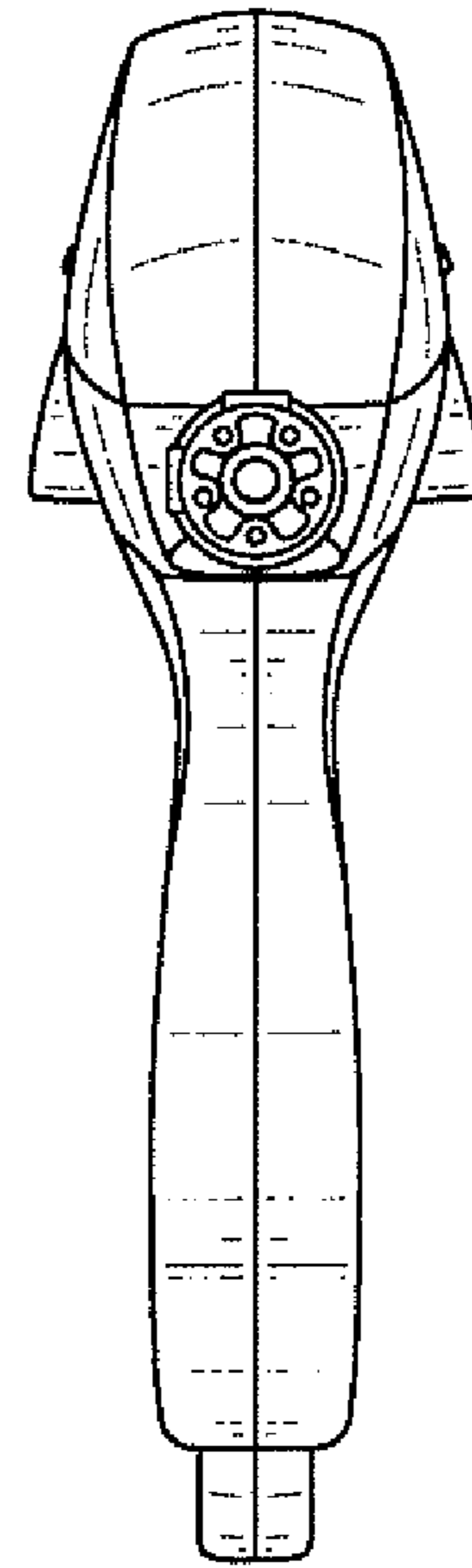

FIG. 4

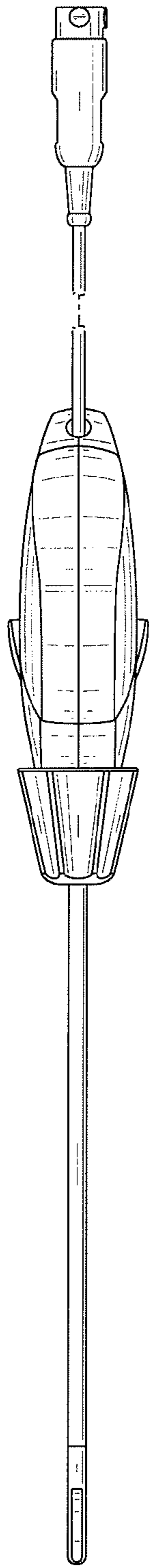

FIG. 5

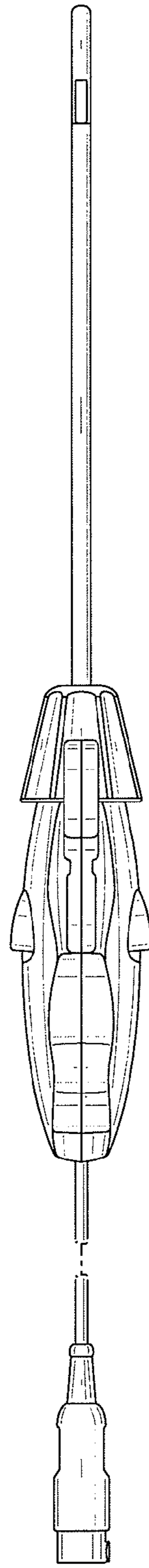

FIG. 6

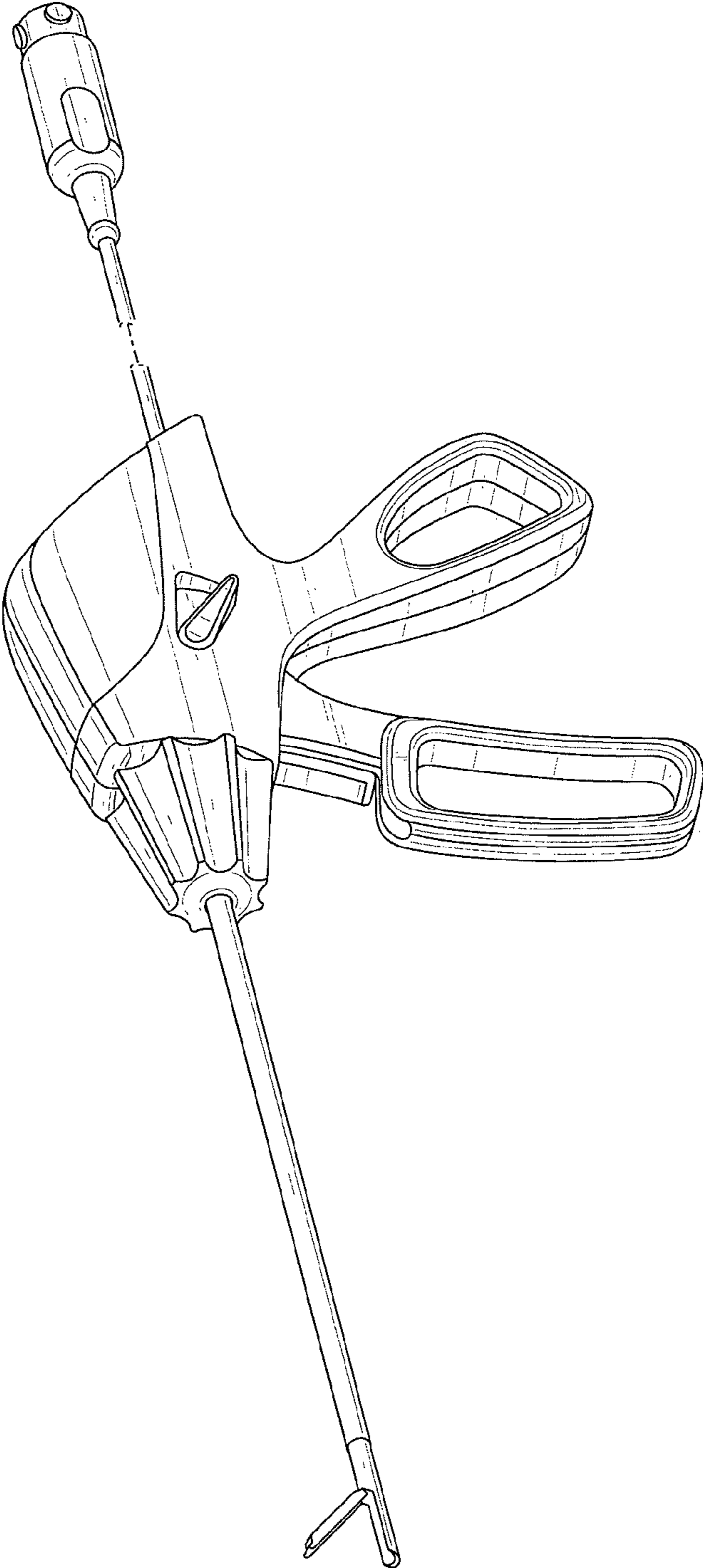

FIG. 7

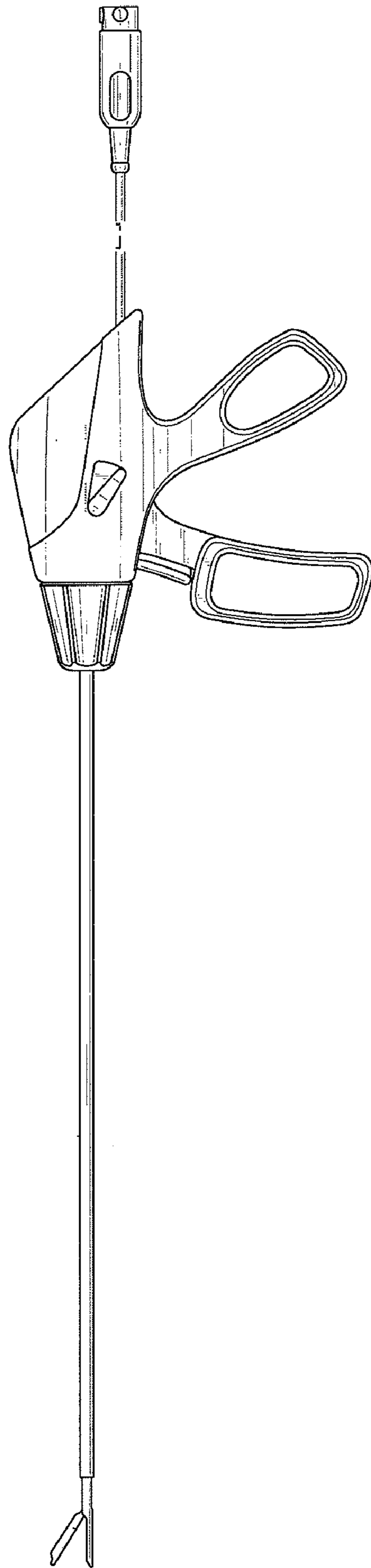

FIG. 8

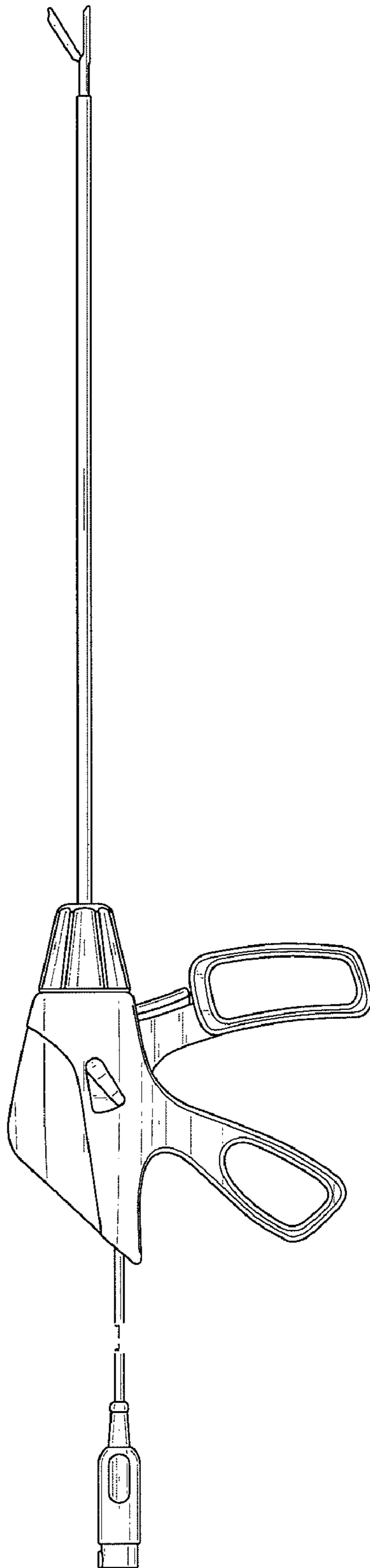

FIG. 9

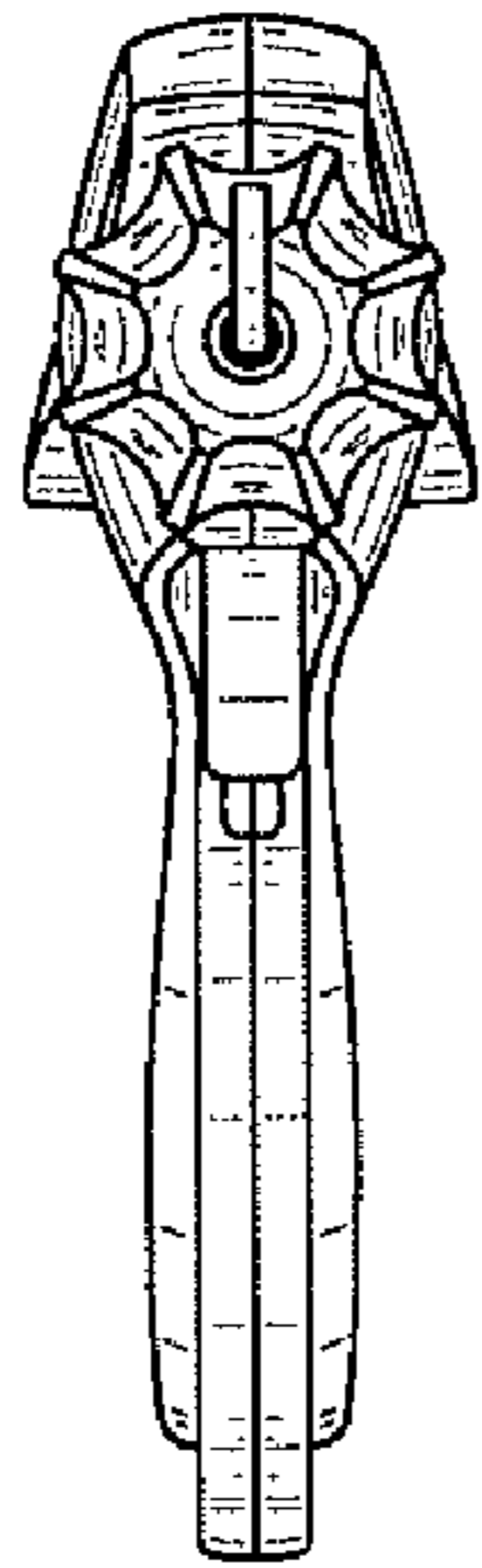

FIG. 10

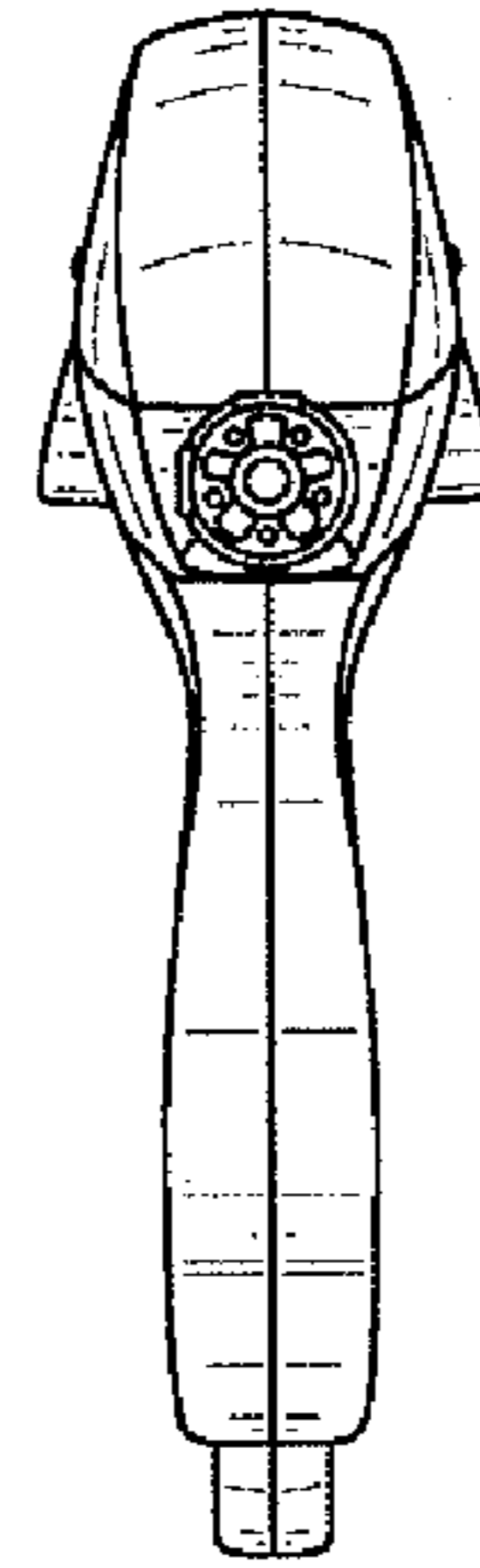

FIG. 11

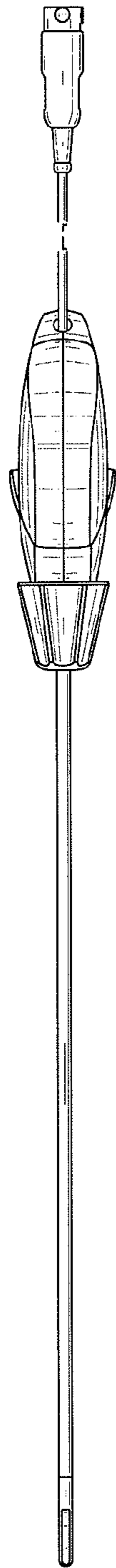

FIG. 12

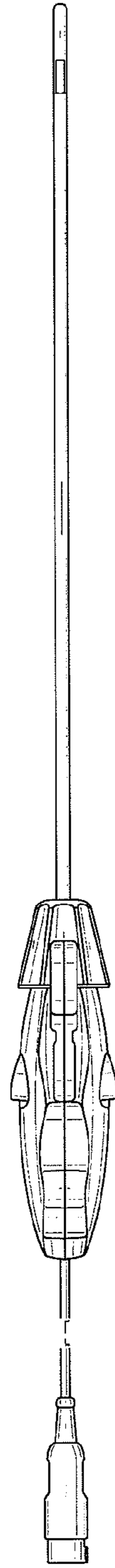

FIG. 13

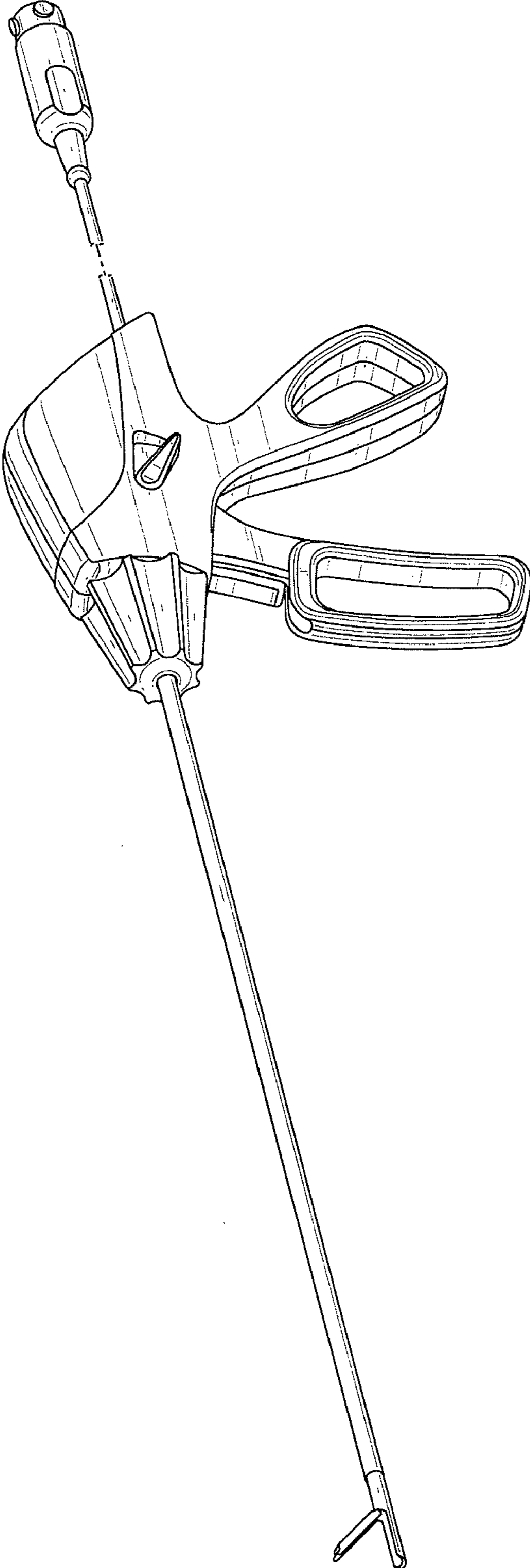

FIG. 14