



US00D668325S

(12) **United States Design Patent**
Kent et al.

(10) **Patent No.:** **US D668,325 S**
(45) **Date of Patent:** **** Oct. 2, 2012**

(54) **FIREBOX**

(75) Inventors: **Jason Kent**, Guelph (CA); **Douglas G. Greenway**, Guelph (CA)

(73) Assignee: **Greenway Home Products Ltd.**, Guelph, Ontario (CA)

(**) Term: **14 Years**

(21) Appl. No.: **29/425,995**

(22) Filed: **Jun. 29, 2012**

Related U.S. Application Data

(62) Division of application No. 29/395,221, filed on Dec. 20, 2011.

(51) **LOC (9) Cl.** **23-03**

(52) **U.S. Cl.** **D23/343**

(58) **Field of Classification Search** D23/342,
D23/351, 355, 378, 370, 381, 364, 336, 341,
D23/343, 344; 126/547, 92 AC, 92 B, 91 R,
126/200

See application file for complete search history.

(56) **References Cited**

U.S. PATENT DOCUMENTS

D264,497 S *	5/1982	Morande, Jr.	D23/344
D301,610 S *	6/1989	Craver	D23/344
D390,936 S *	2/1998	French et al.	D23/350
D591,409 S *	4/2009	Kashimoto	D23/351
D591,410 S *	4/2009	Kashimoto	D23/351
7,726,299 B2 *	6/2010	Reyher	126/512
D638,922 S *	5/2011	Zhou	D23/344
D658,750 S *	5/2012	Nemes	D23/344

* cited by examiner

Primary Examiner — Eric Goodman

(74) *Attorney, Agent, or Firm* — Norton Rose Canada LLP

(57) **CLAIM**

The ornamental design for a firebox, as shown and described.

DESCRIPTION

FIG. 1 is a front perspective view of a first embodiment of the firebox.

FIG. 2 is a back perspective view of FIG. 1.

FIG. 3 is a front plan view of FIG. 1.

FIG. 4 is a back plan view of FIG. 1.

FIG. 5 is a right plan view of FIG. 1.

FIG. 6 is a left plan view of FIG. 1.

FIG. 7 is a top plan view of FIG. 1.

FIG. 8 is a bottom plan view of FIG. 1.

FIG. 9 is a front perspective view of a second embodiment of the firebox.

FIG. 10 is a back perspective view of FIG. 9.

FIG. 11 is a front plan view of FIG. 9.

FIG. 12 is a back plan view of FIG. 9.

FIG. 13 is a right plan view of FIG. 9.

FIG. 14 is a left plan view of FIG. 9.

FIG. 15 is a top plan view of FIG. 9.

FIG. 16 is a bottom plan view of FIG. 9.

FIG. 17 is a front perspective view of a third embodiment of the firebox.

FIG. 18 is a back perspective view of FIG. 17.

FIG. 19 is a front plan view of FIG. 17.

FIG. 20 is a back plan view of FIG. 17.

FIG. 21 is a right plan view of FIG. 17.

FIG. 22 is a left plan view of FIG. 17.

FIG. 23 is a top plan view of FIG. 17.

FIG. 24 is a bottom plan view of FIG. 17.

FIG. 25 is a front perspective view of a fourth embodiment of the firebox.

FIG. 26 is a back perspective view of FIG. 25.

FIG. 27 is a front plan view of FIG. 25.

FIG. 28 is a back plan view of FIG. 25.

FIG. 29 is a right plan view of FIG. 25.

FIG. 30 is a left plan view of FIG. 25.

FIG. 31 is a top plan view of FIG. 25.

FIG. 32 is a bottom plan view of FIG. 25.

FIG. 33 is a front perspective view of a fifth embodiment of the firebox.

FIG. 34 is a back perspective view of FIG. 33.

FIG. 35 is a front plan view of FIG. 33.

FIG. 36 is a back plan view of FIG. 33.

FIG. 37 is a right plan view of FIG. 33.

FIG. 38 is a left plan view of FIG. 33.

FIG. 39 is a top plan view of FIG. 33.

FIG. 40 is a bottom plan view of FIG. 33.

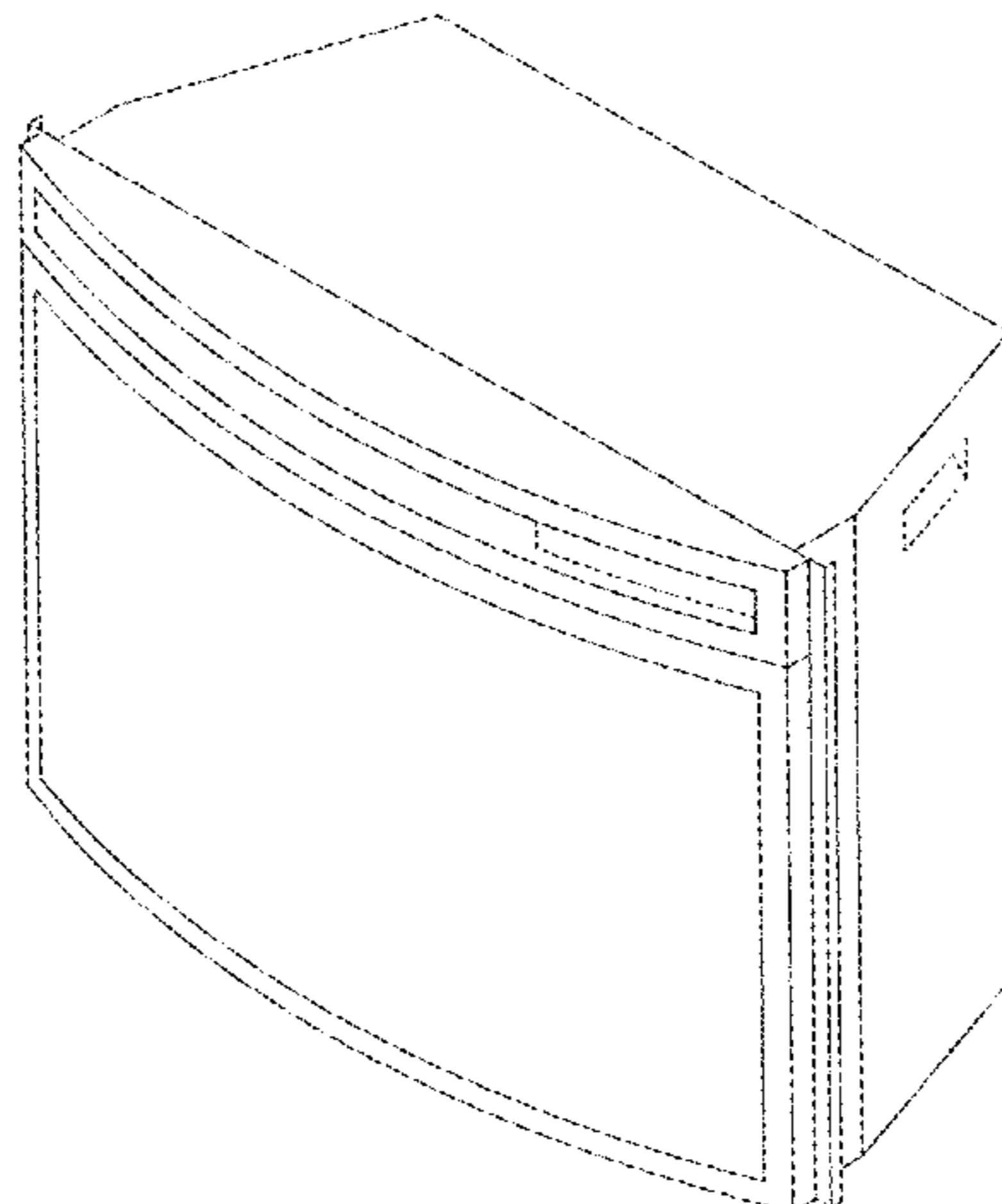

FIG. 41 is a front perspective view of a sixth embodiment of the firebox.

FIG. 42 is a back perspective view of FIG. 41.

FIG. 43 is a front plan view of FIG. 41

FIG. 44 is a back plan view of FIG. 41.

FIG. 45 is a right plan view of FIG. 41.

FIG. 46 is a left plan view of FIG. 41.

FIG. 47 is a top plan view of FIG. 41.

FIG. 48 is a bottom plan view of FIG. 41.

FIG. 49 is a front perspective view of a seventh embodiment of the firebox.

FIG. 50 is a back perspective view of FIG. 49.

FIG. 51 is a front plan view of FIG. 49.

FIG. 52 is a back plan view of FIG. 49.

FIG. 53 is a right plan view of FIG. 49.

FIG. 54 is a left plan view of FIG. 49.

FIG. 55 is a top plan view of FIG. 49.

FIG. 56 is a bottom plan view FIG. 49.

FIG. 57 is a front perspective view of an eighth embodiment of the firebox.

FIG. 58 is a back perspective view of FIG. 57.

FIG. 59 is a front plan view of FIG. 57.

FIG. 60 is a back plan view of FIG. 57.

FIG. 61 is a right plan view of FIG. 57.

FIG. 62 is a left plan view of FIG. 57.

FIG. 63 is a top plan view of FIG. 57.

FIG. 64 is a bottom plan view of FIG. 57.

FIG. 65 is a front perspective view of a ninth embodiment of the firebox.

FIG. 66 is a back perspective view of FIG. 65

FIG. 67 is a front plan view of FIG. 65.

FIG. 68 is a back plan view of FIG. 65.

FIG. 69 is a right plan view of FIG. 65.

FIG. 70 is a left plan view of FIG. 65.

FIG. 71 is a top plan view of FIG. 65.

FIG. 72 is a bottom plan view of FIG. 65.

FIG. 73 is a front perspective view of a tenth embodiment of the firebox.

FIG. 74 is a back perspective view of FIG. 73.

FIG. 75 is a front plan view of FIG. 73.

FIG. 76 is a back plan view of FIG. 73.

FIG. 77 is a right plan view of FIG. 73.

FIG. 78 is a left plan view of FIG. 73.

FIG. 79 is a top plan view of FIG. 73; and,

FIG. 80 is a bottom plan view FIG. 73.

1 Claim, 80 Drawing Sheets

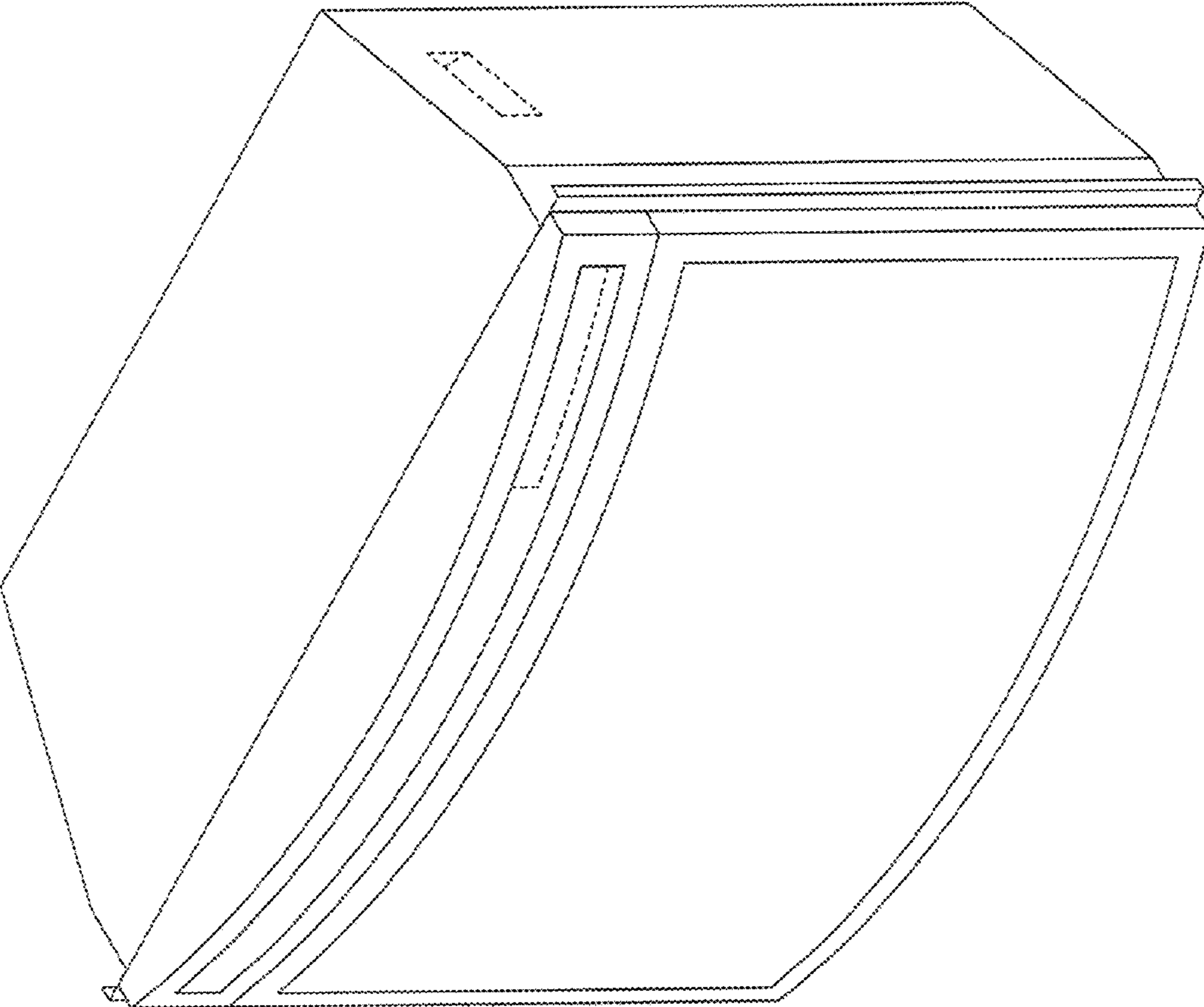

FIG. 1

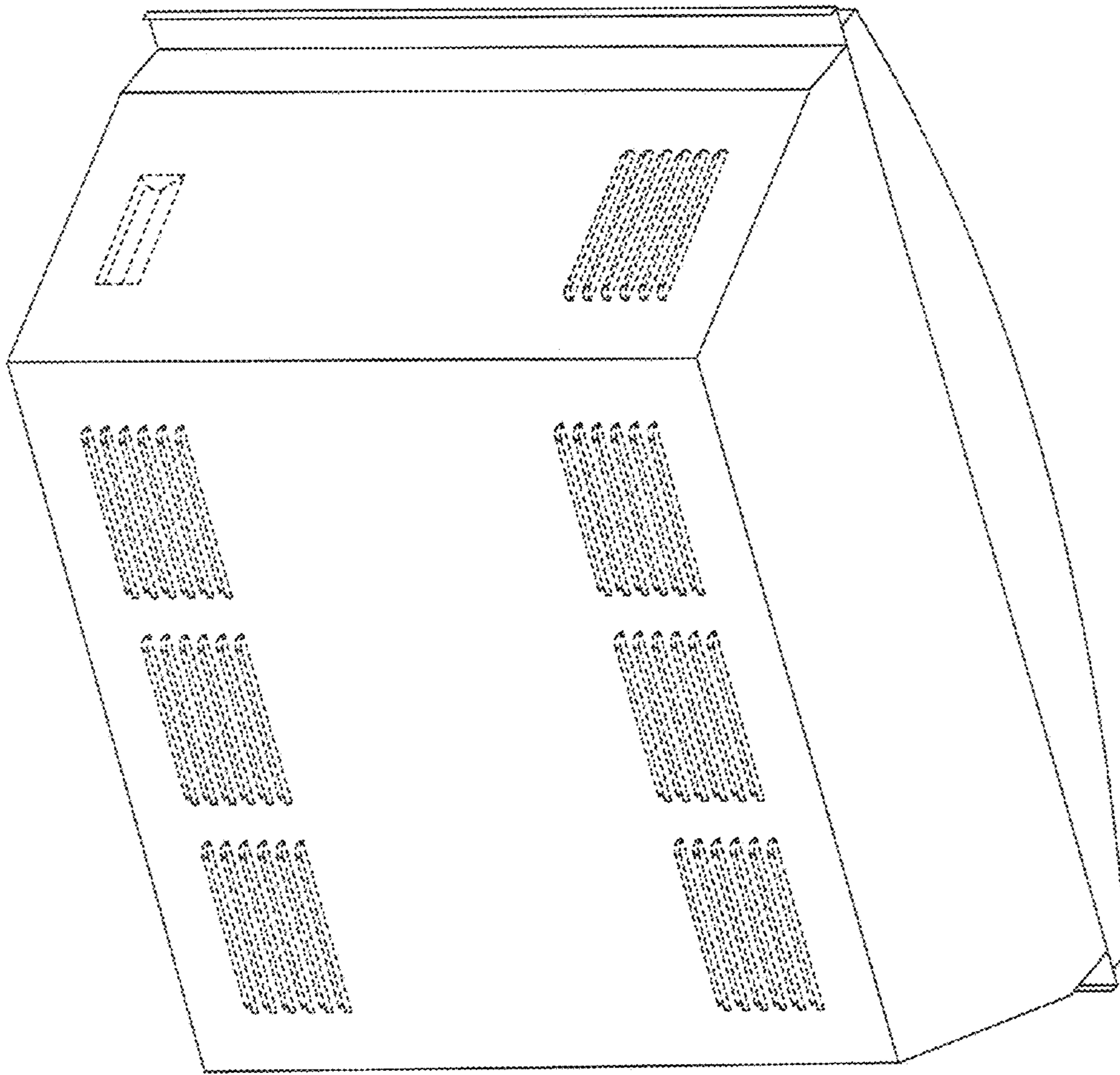

FIG. 2

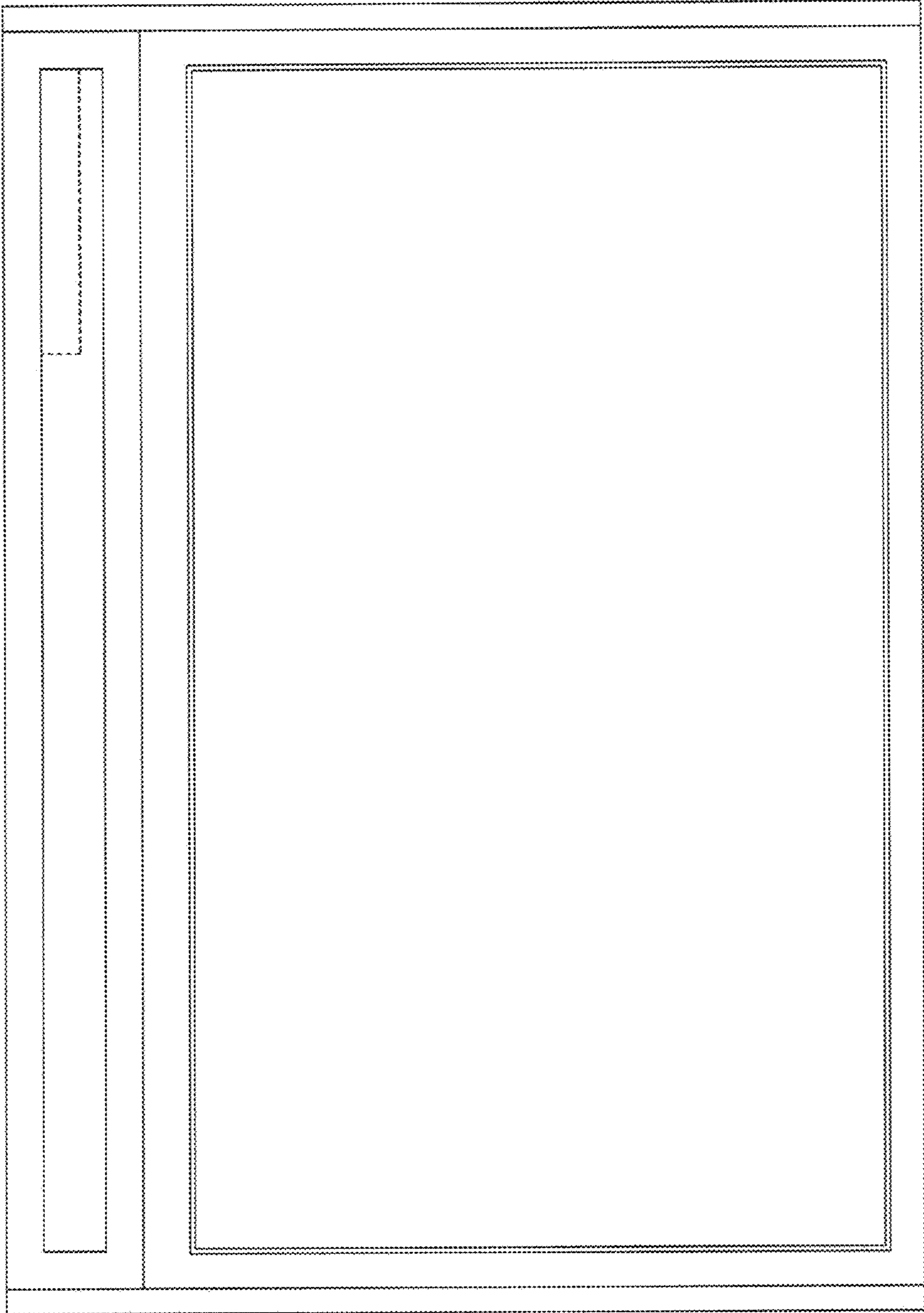

FIG. 3

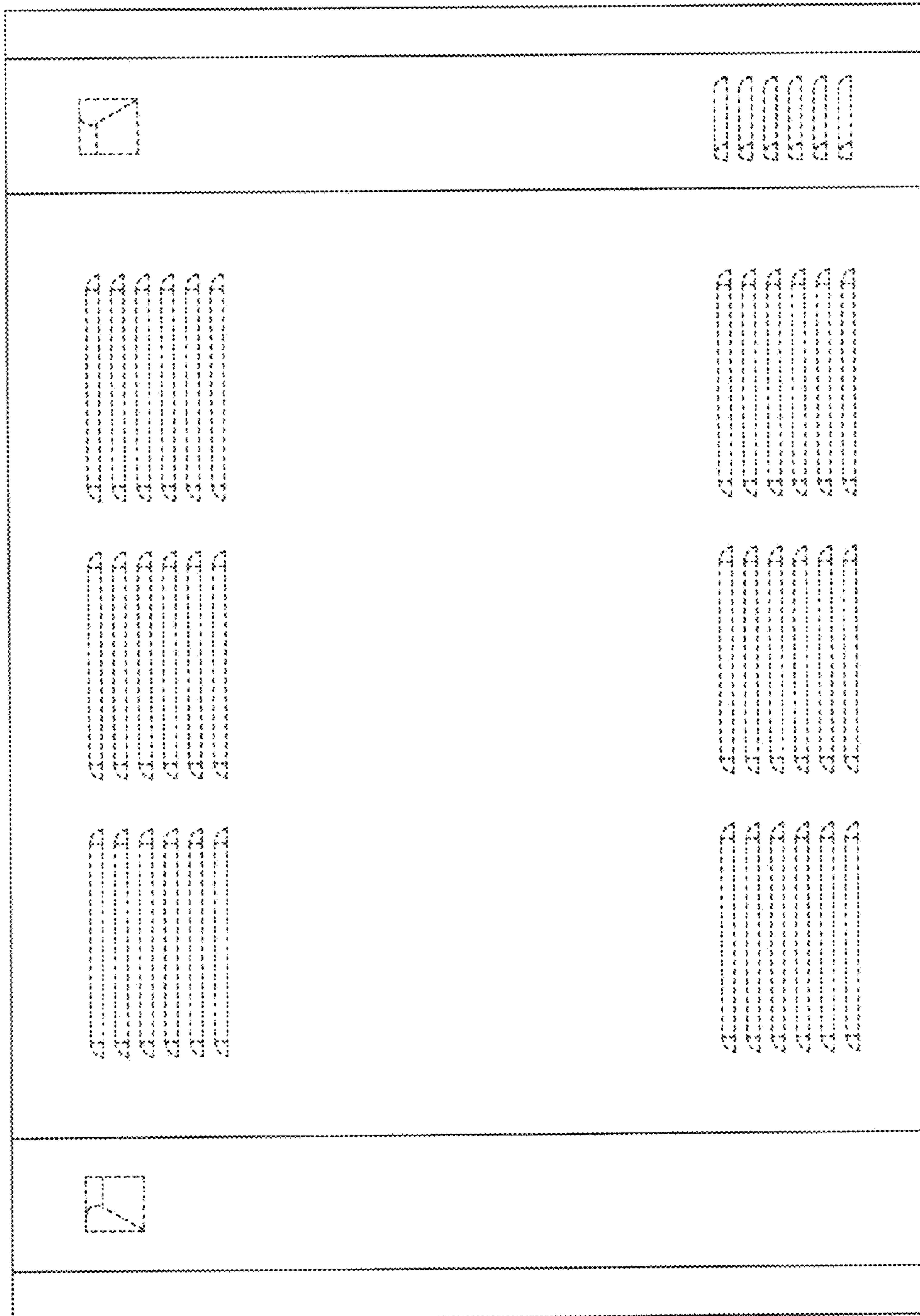

FIG. 4

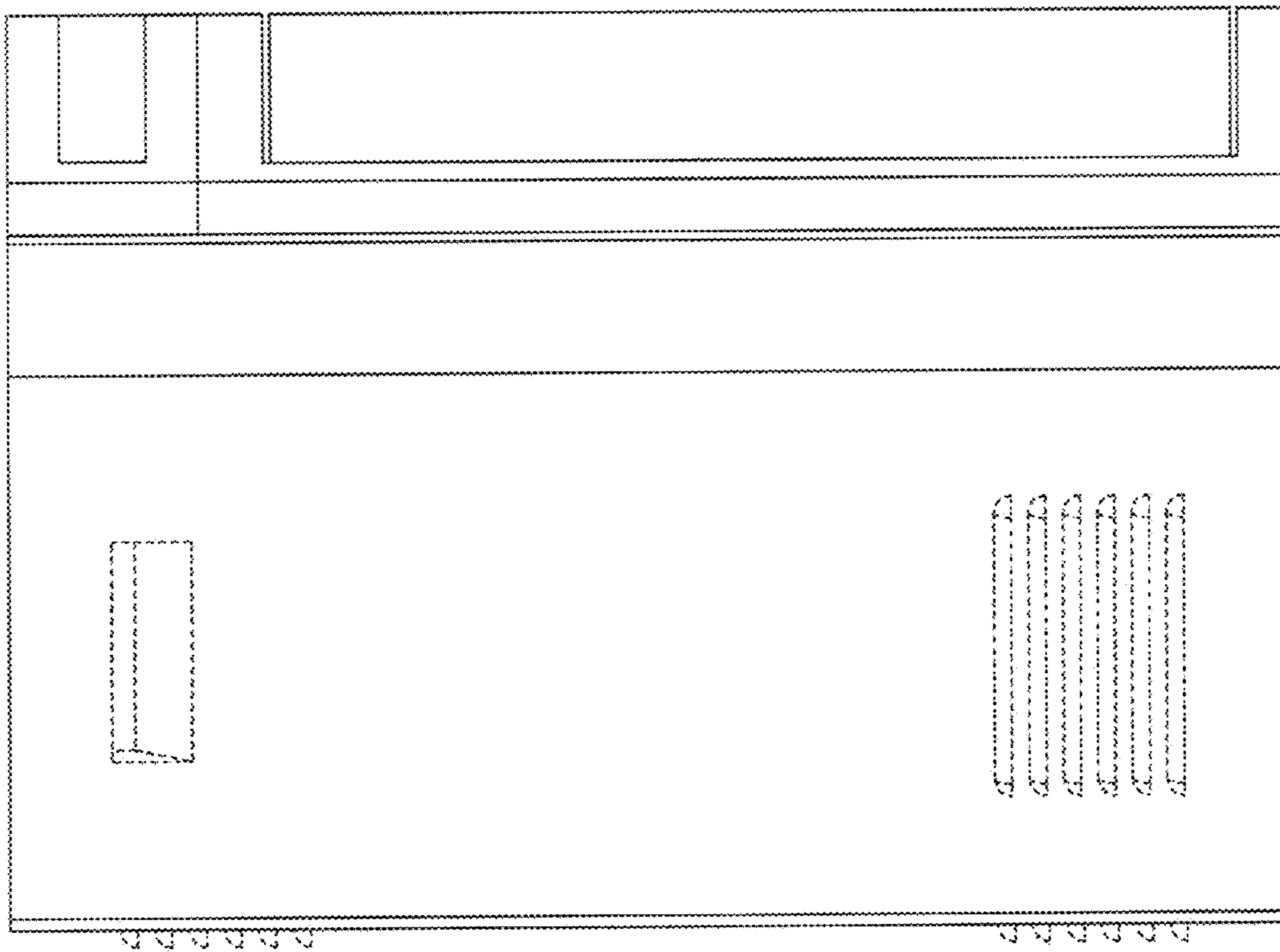

FIG. 5

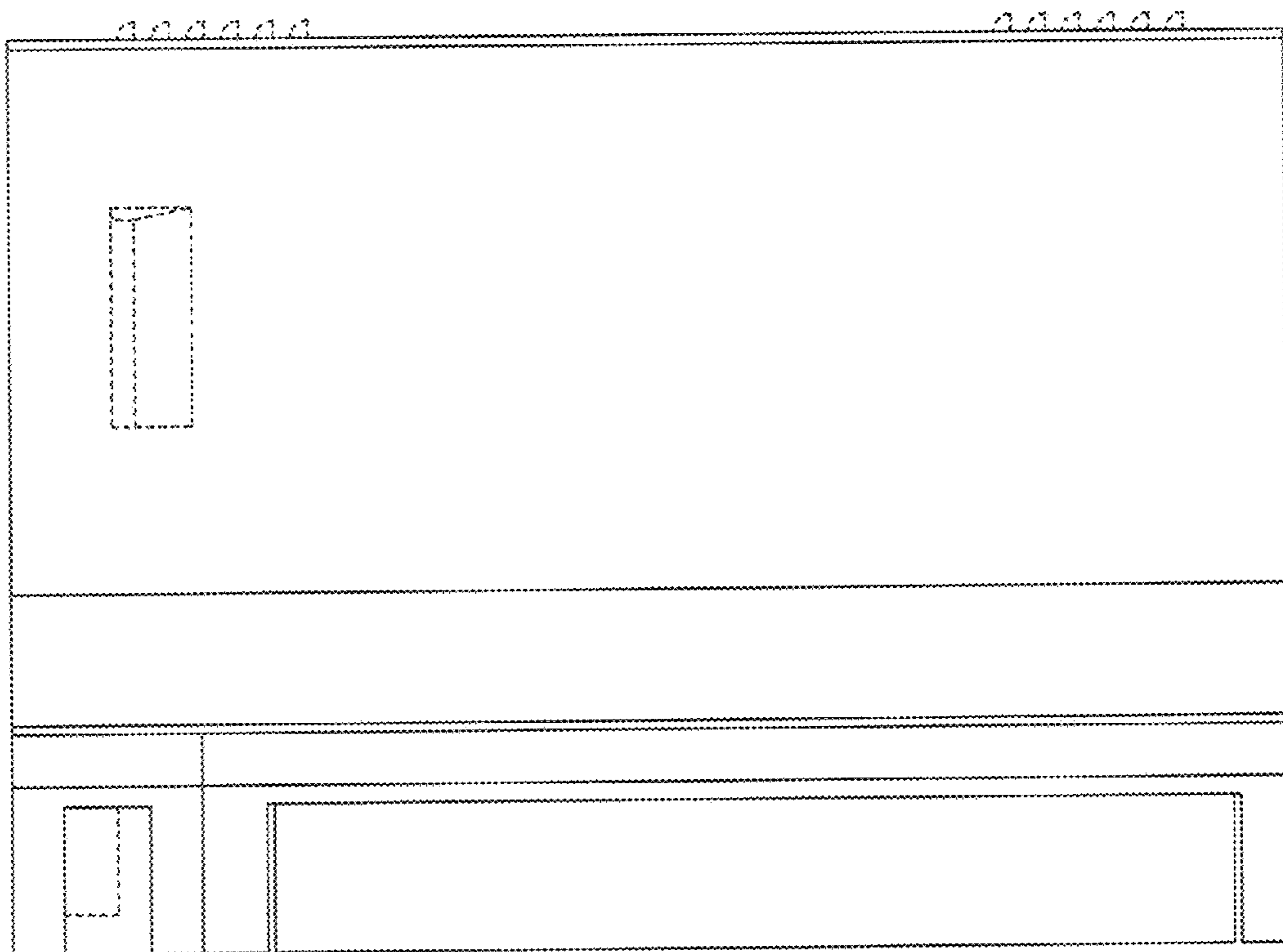

FIG. 6

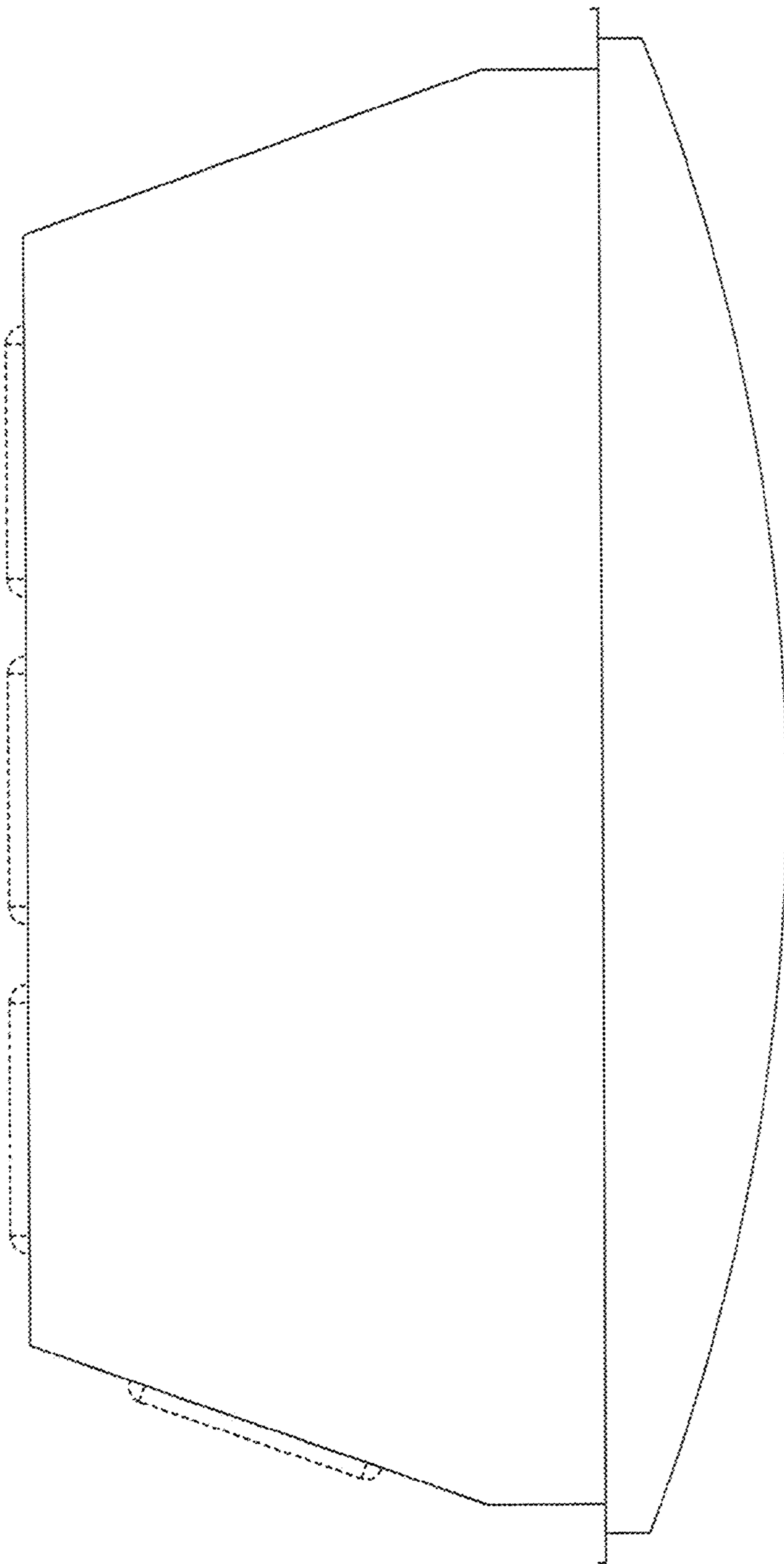

FIG. 7

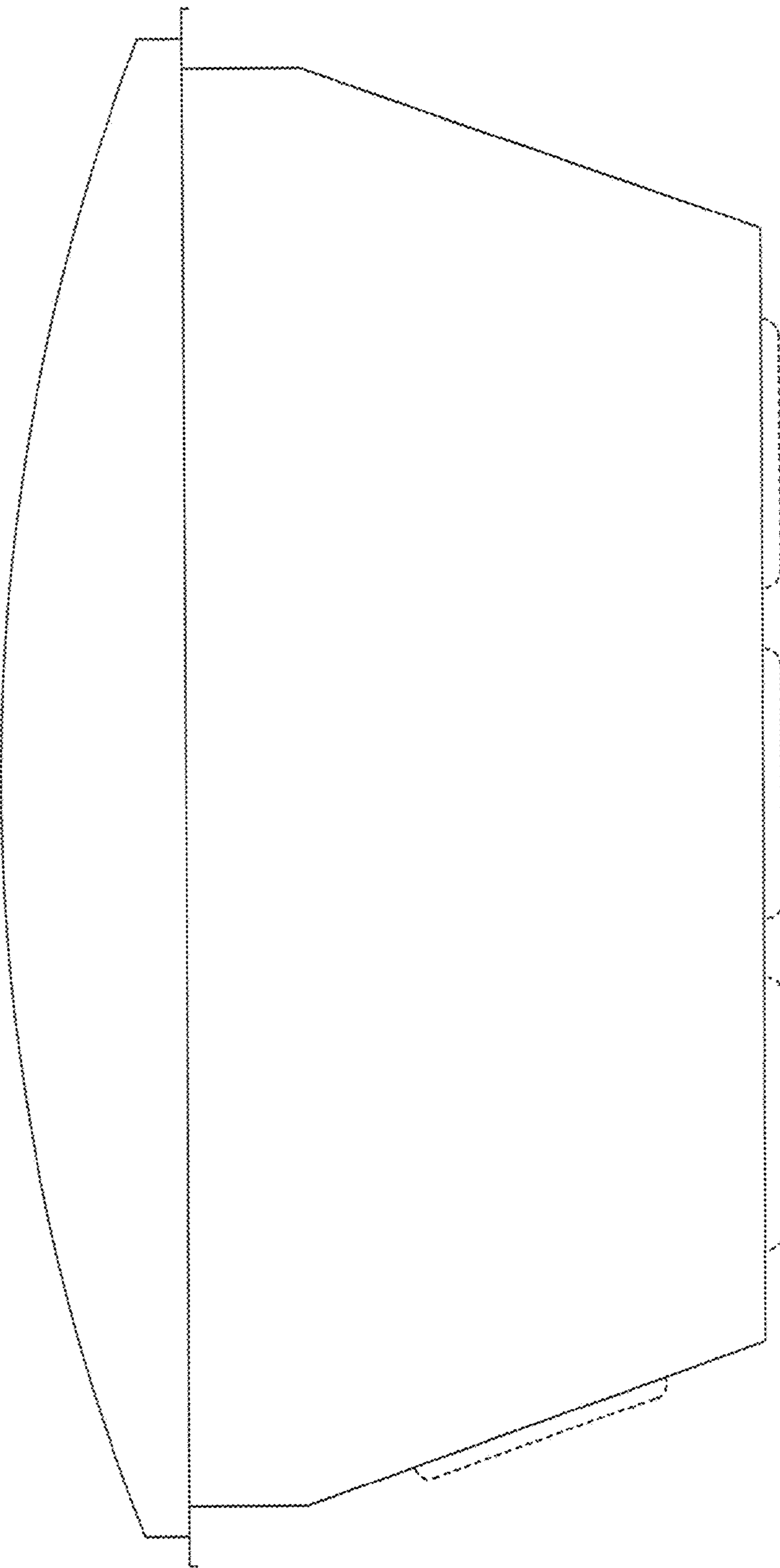

FIG. 8

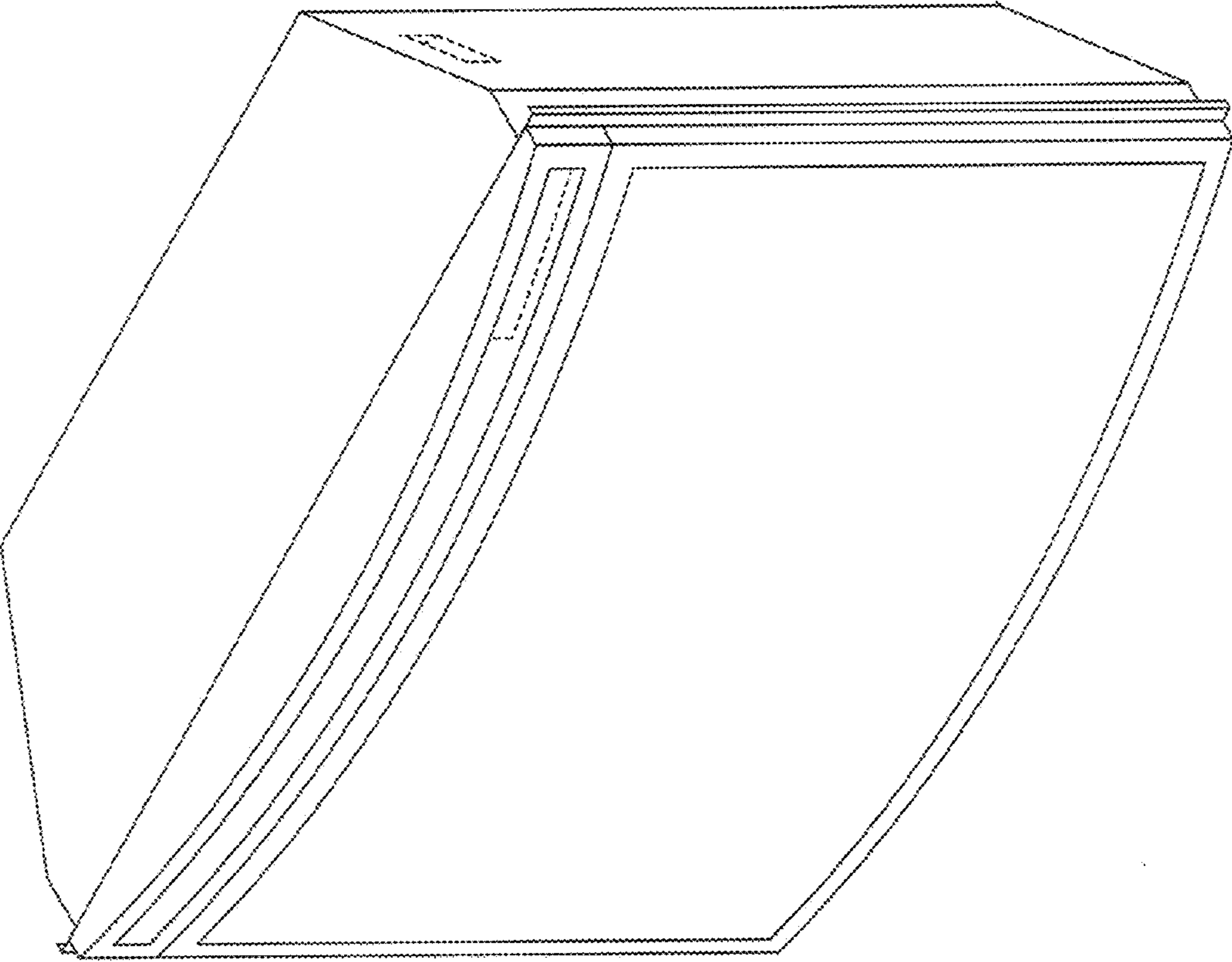

FIG. 9

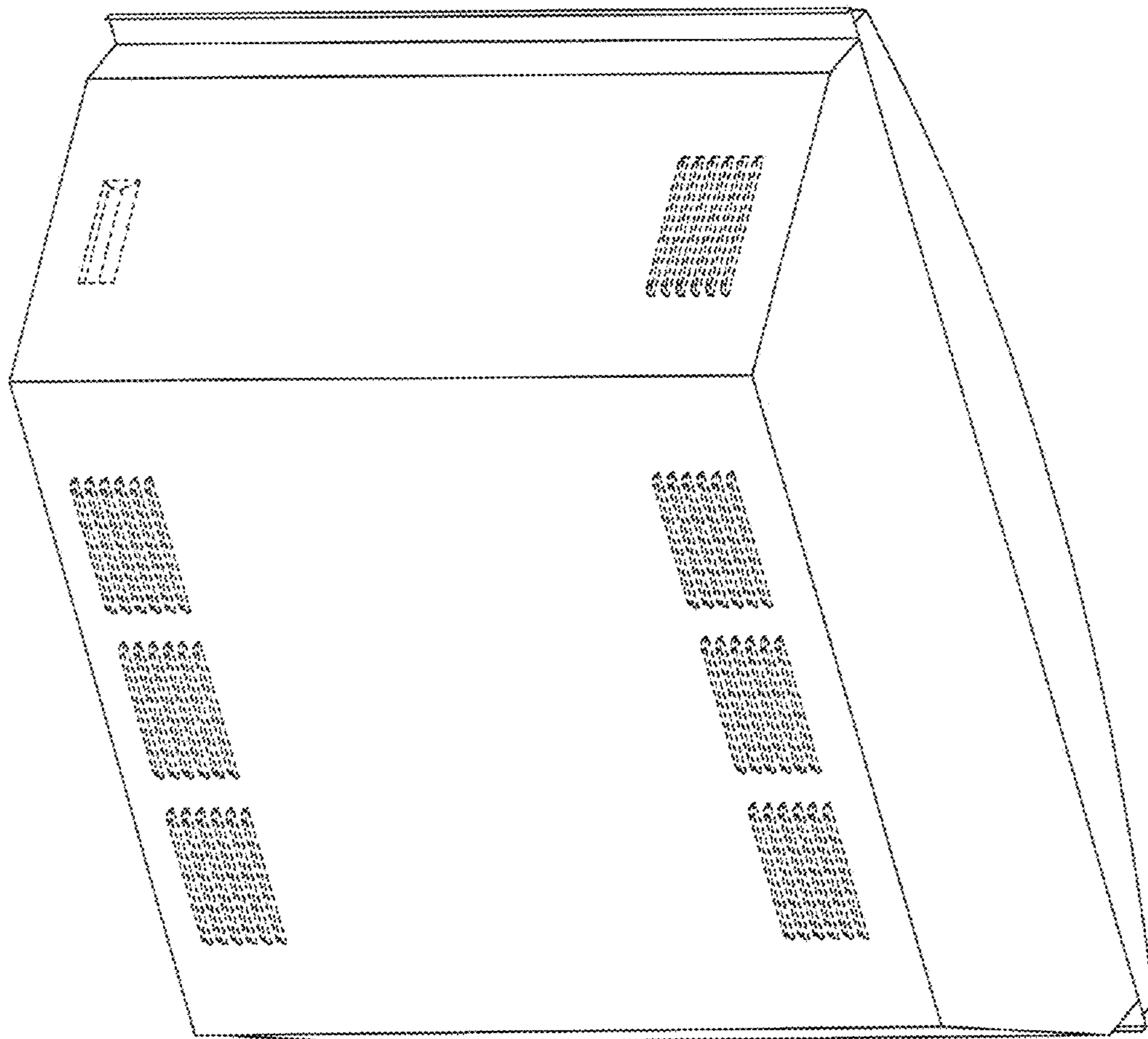

FIG. 10

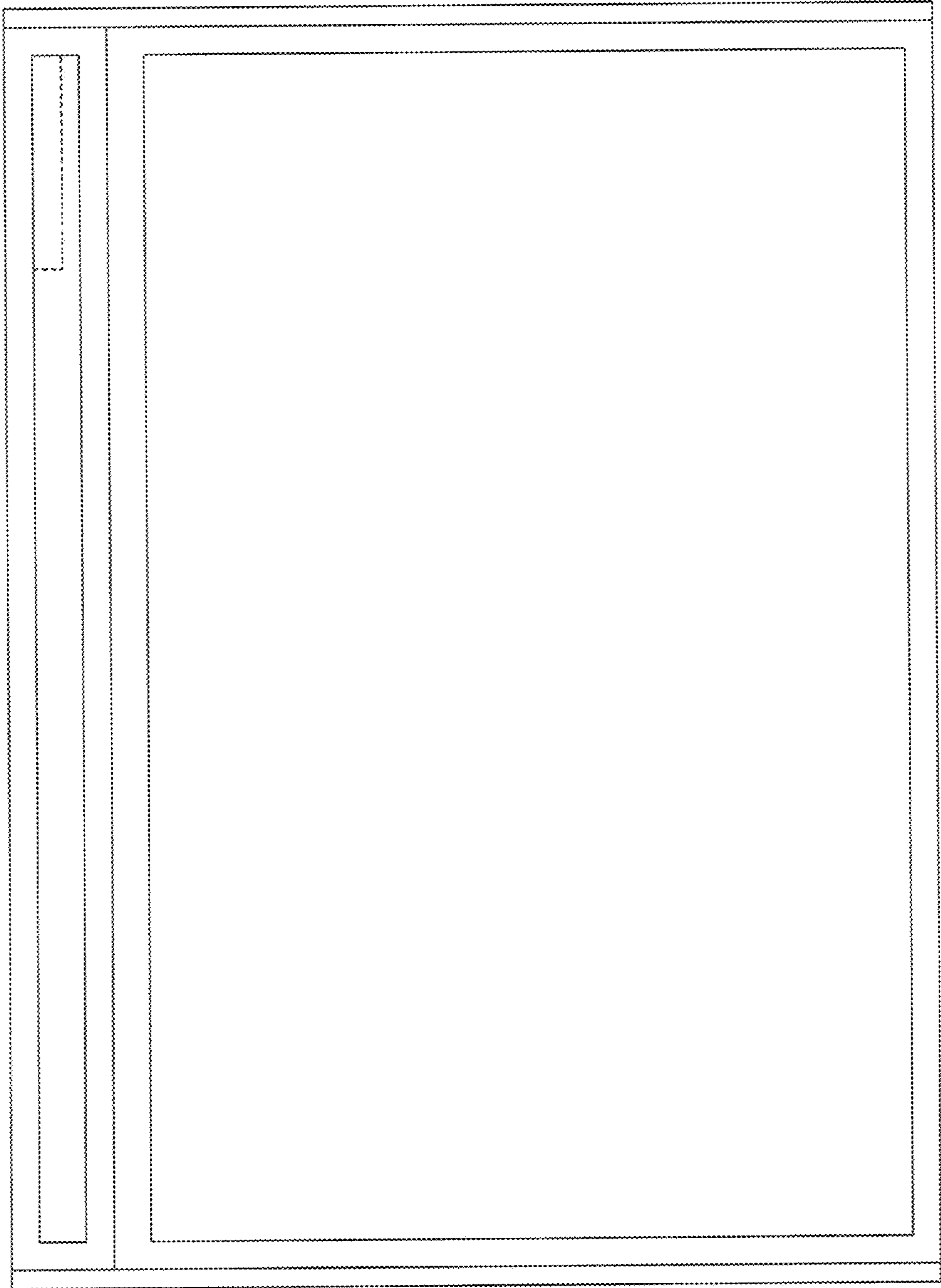

FIG. 11

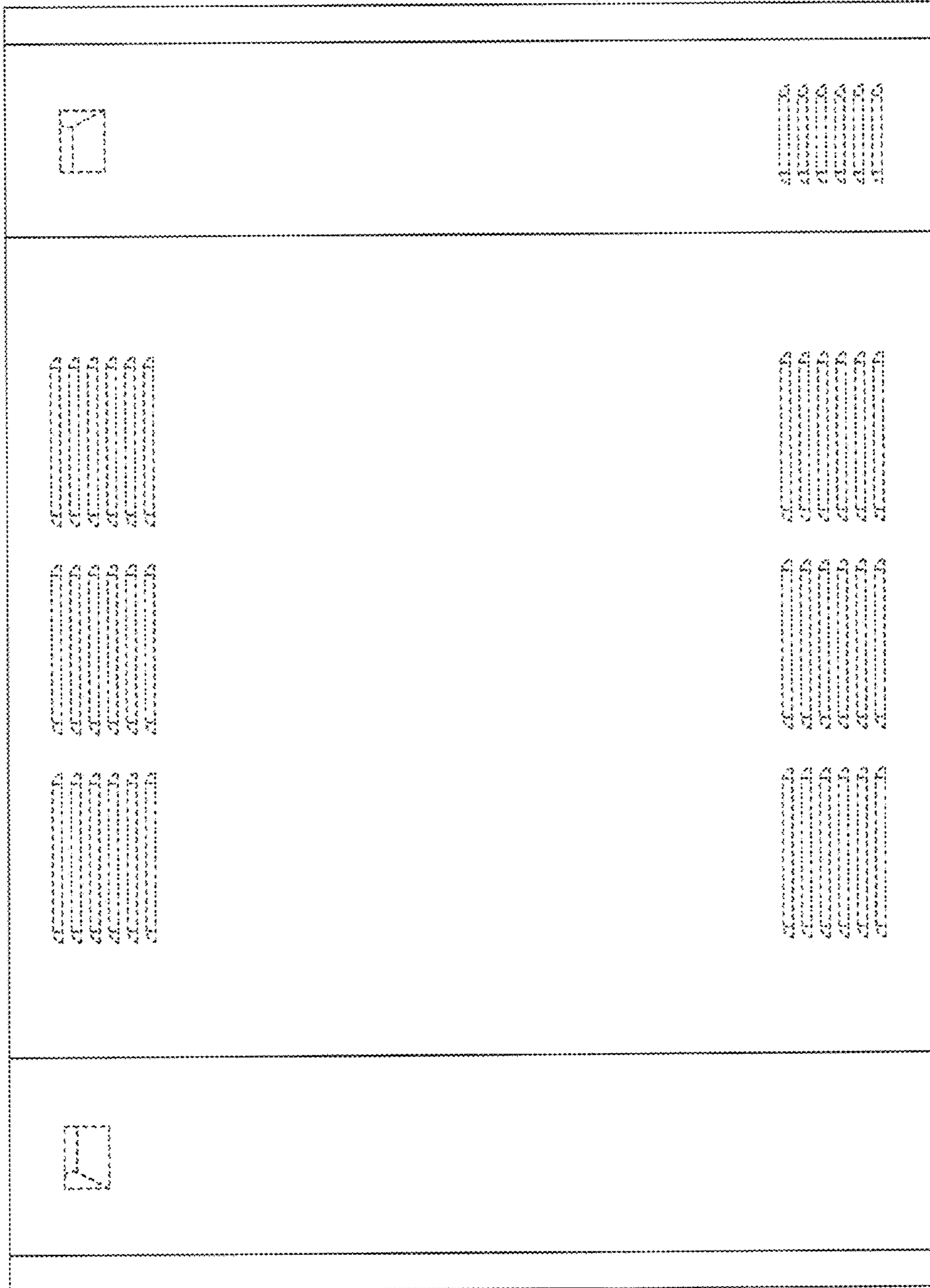

FIG. 12

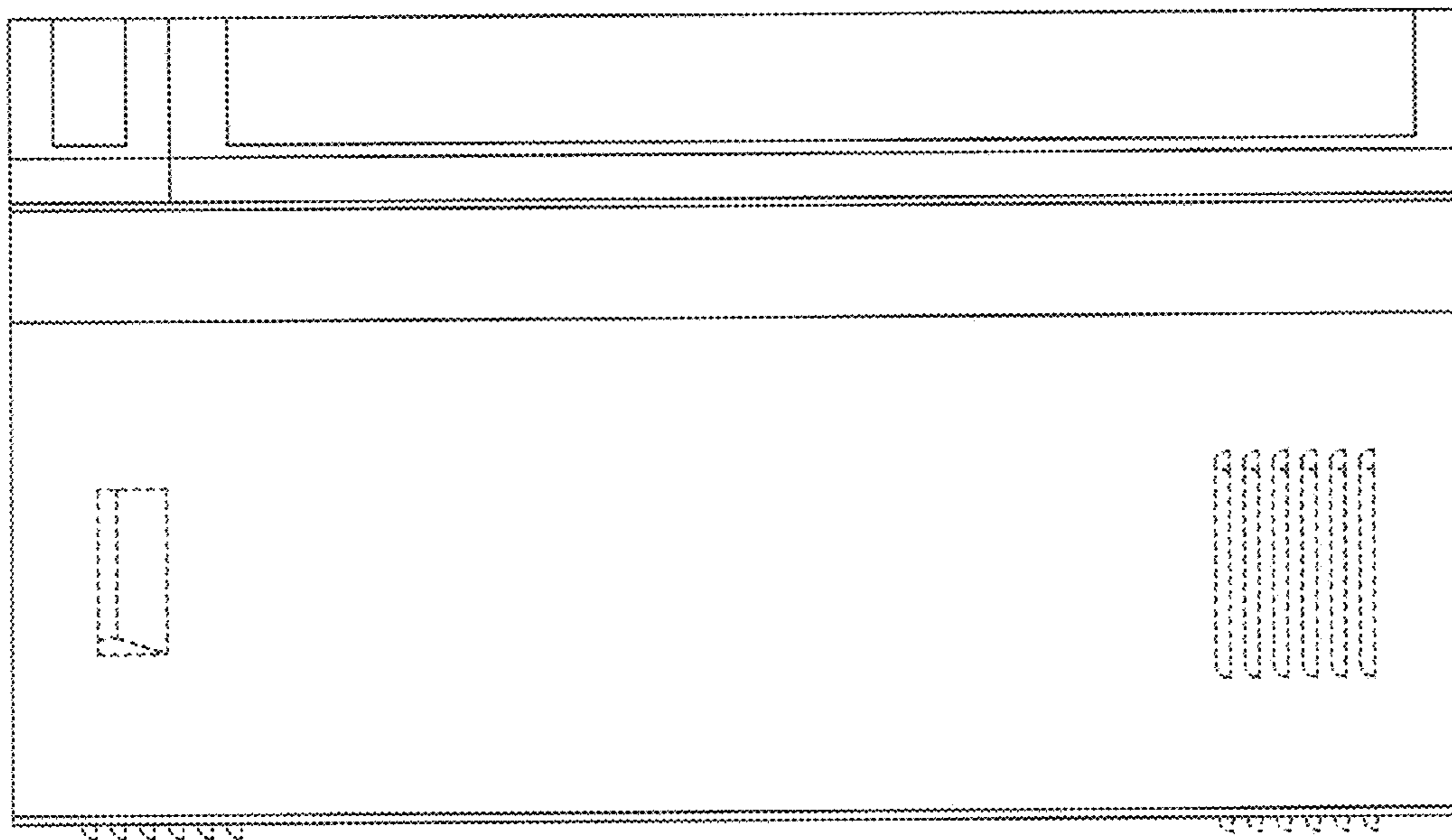

FIG. 13

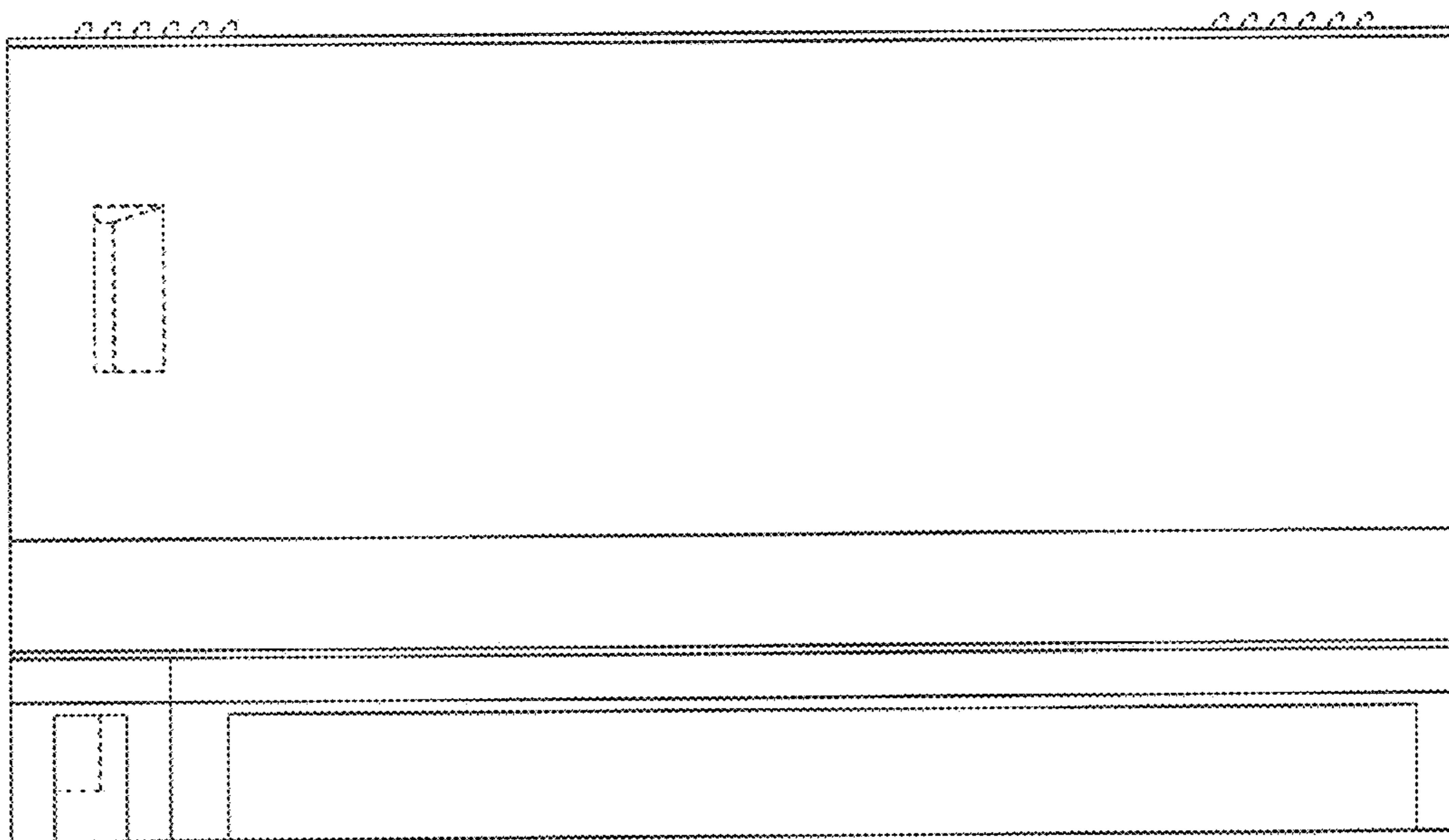

FIG. 14

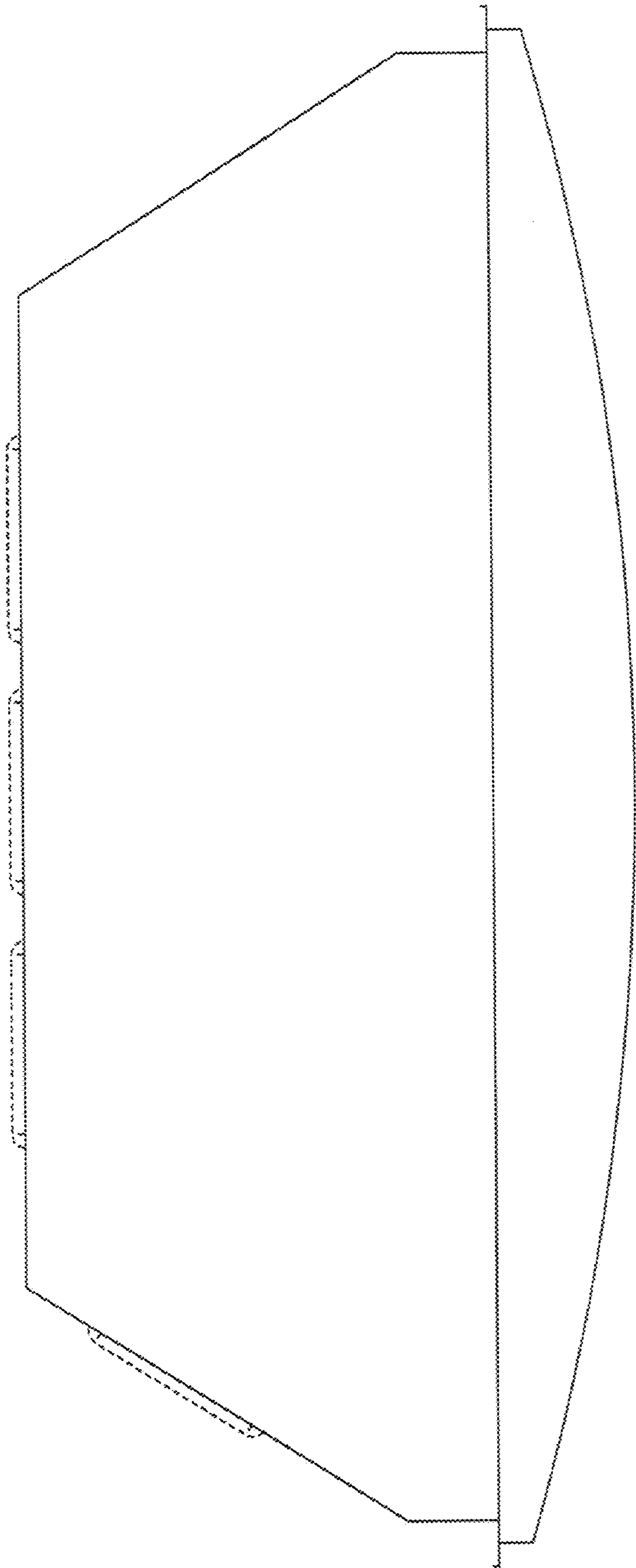

FIG. 15

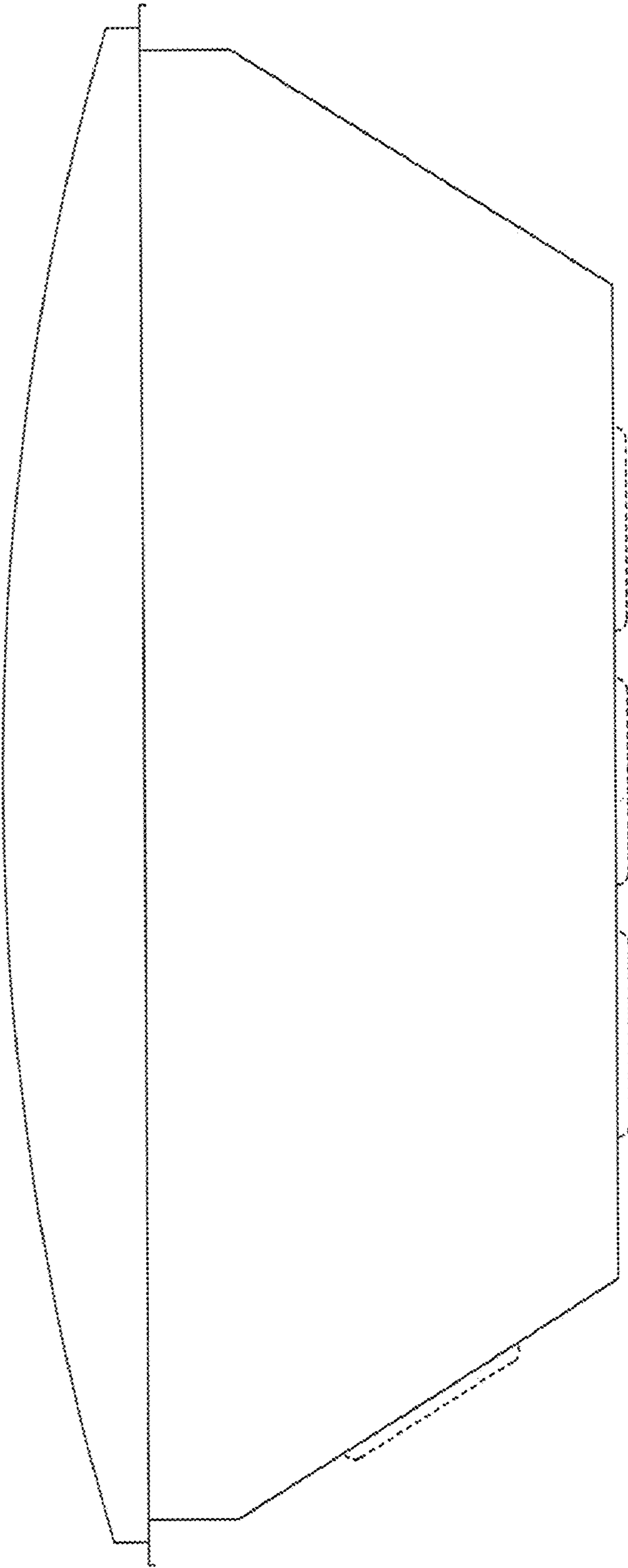

FIG. 16

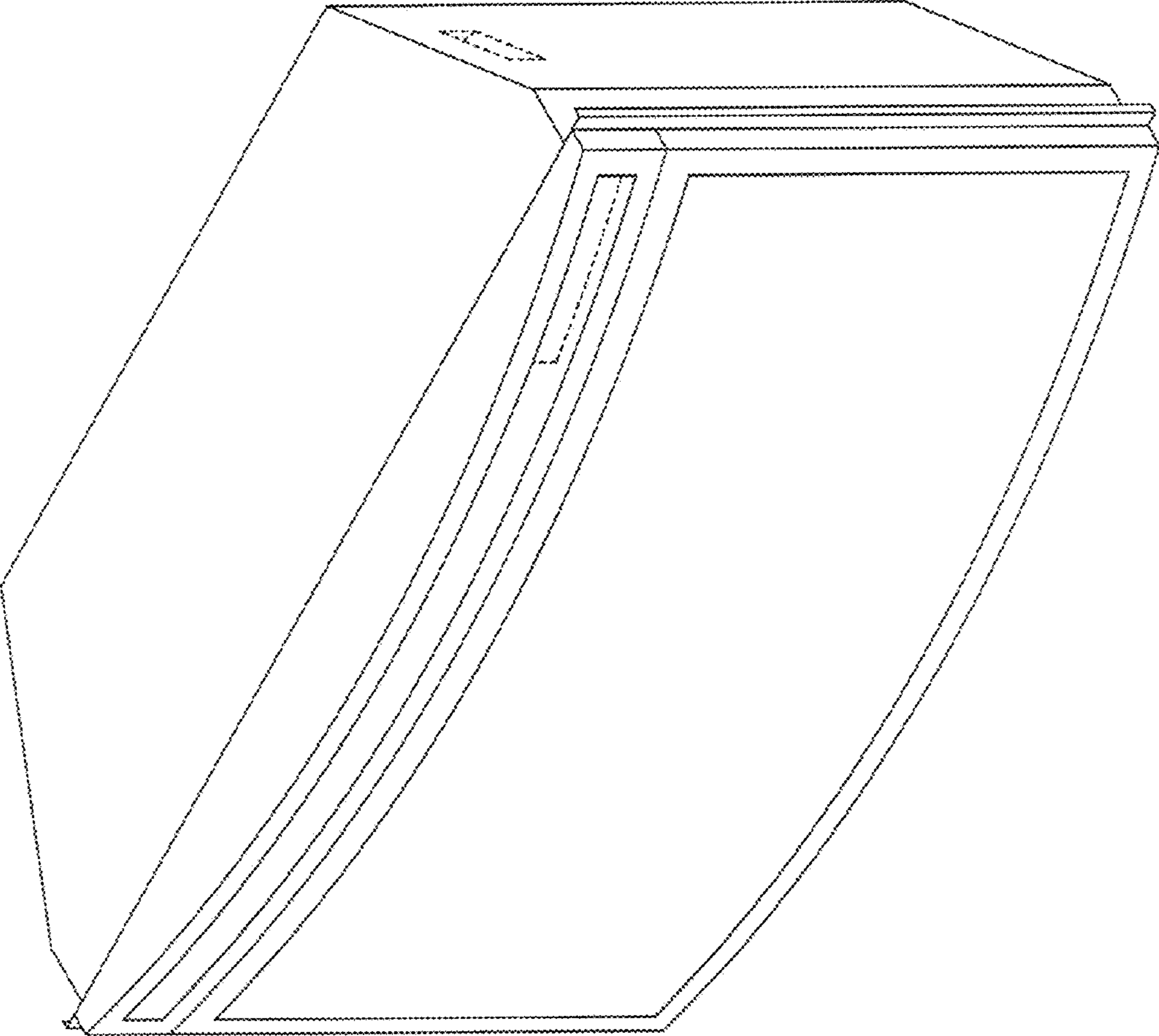

FIG. 17

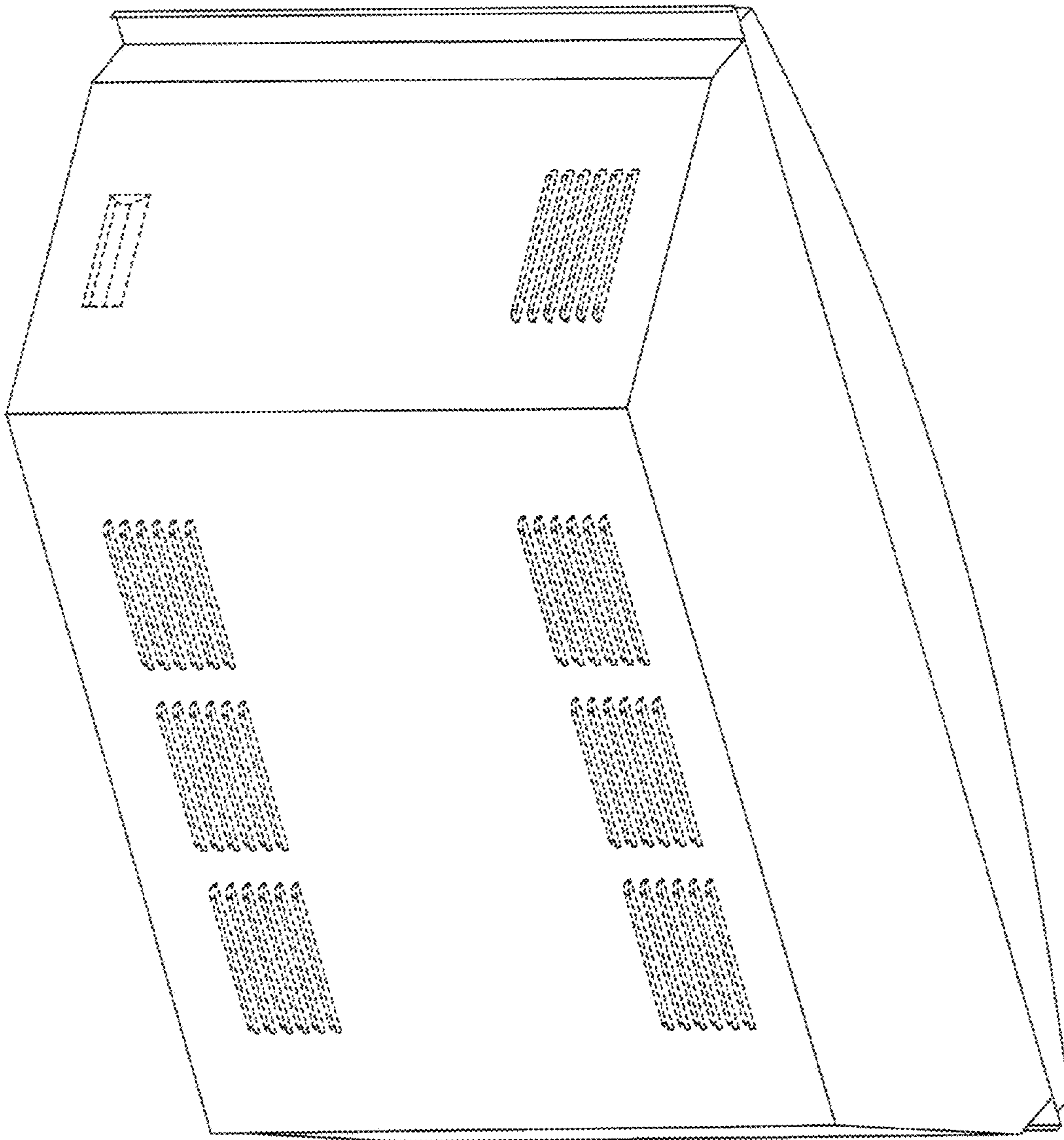

FIG. 18

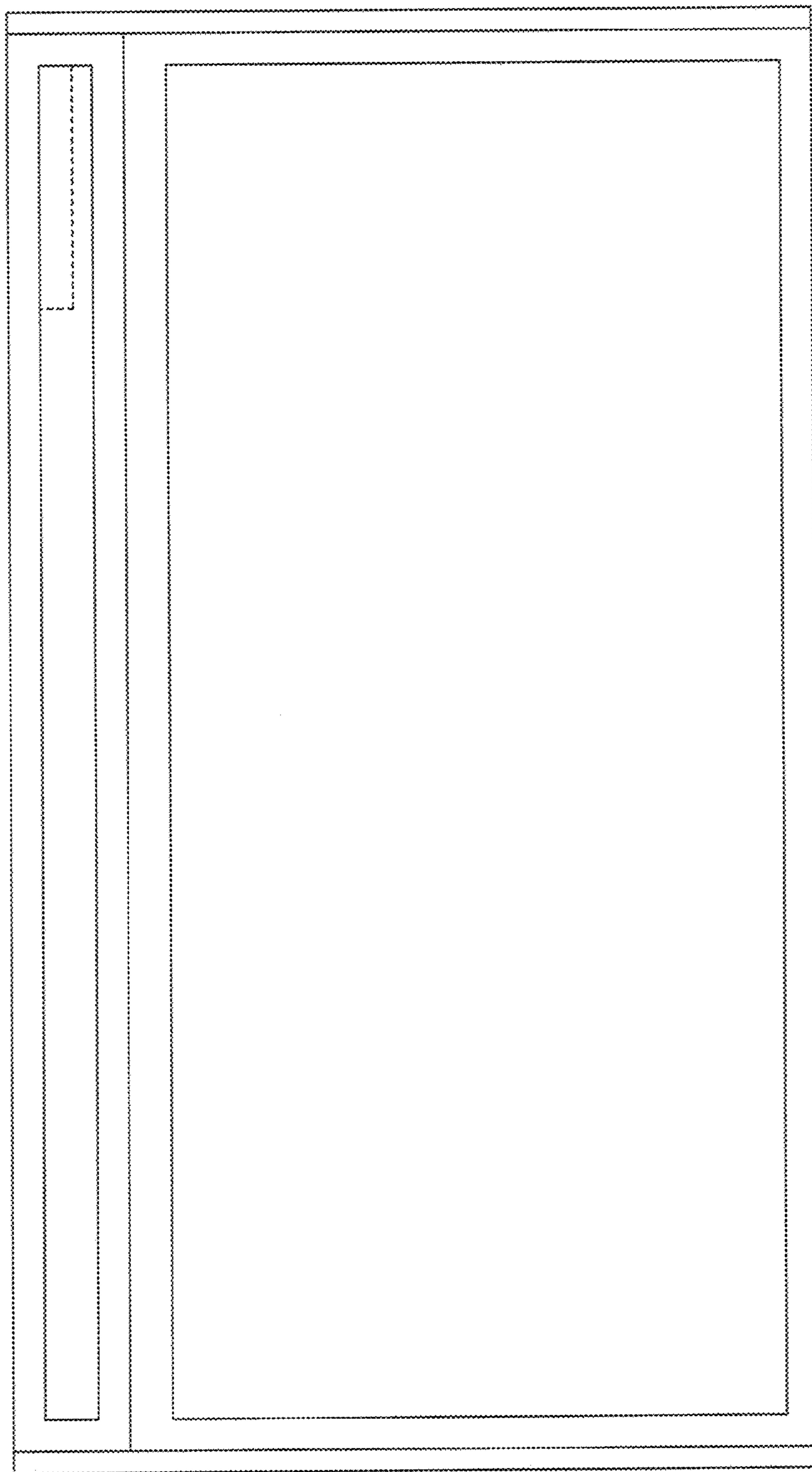

FIG. 19

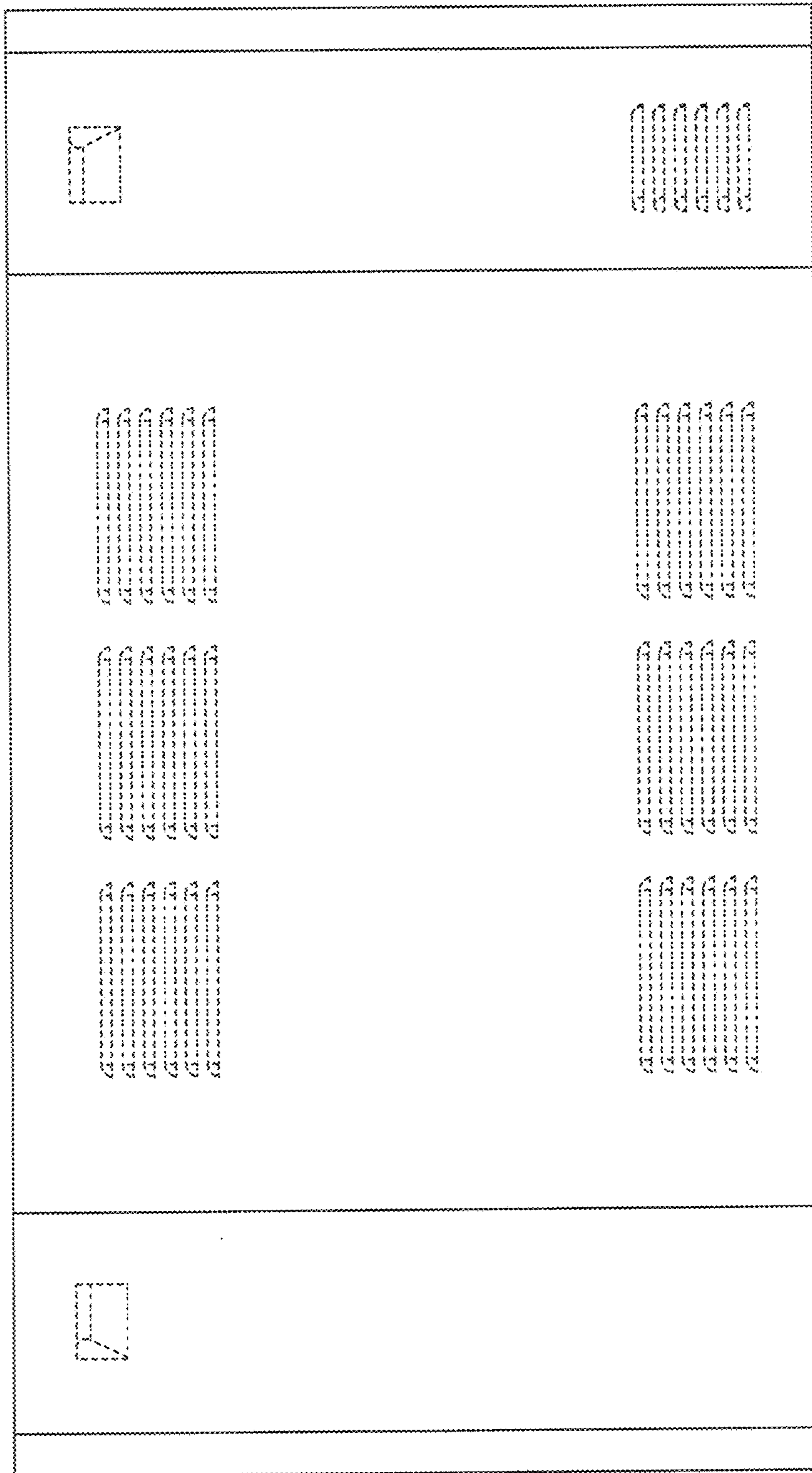

FIG. 20

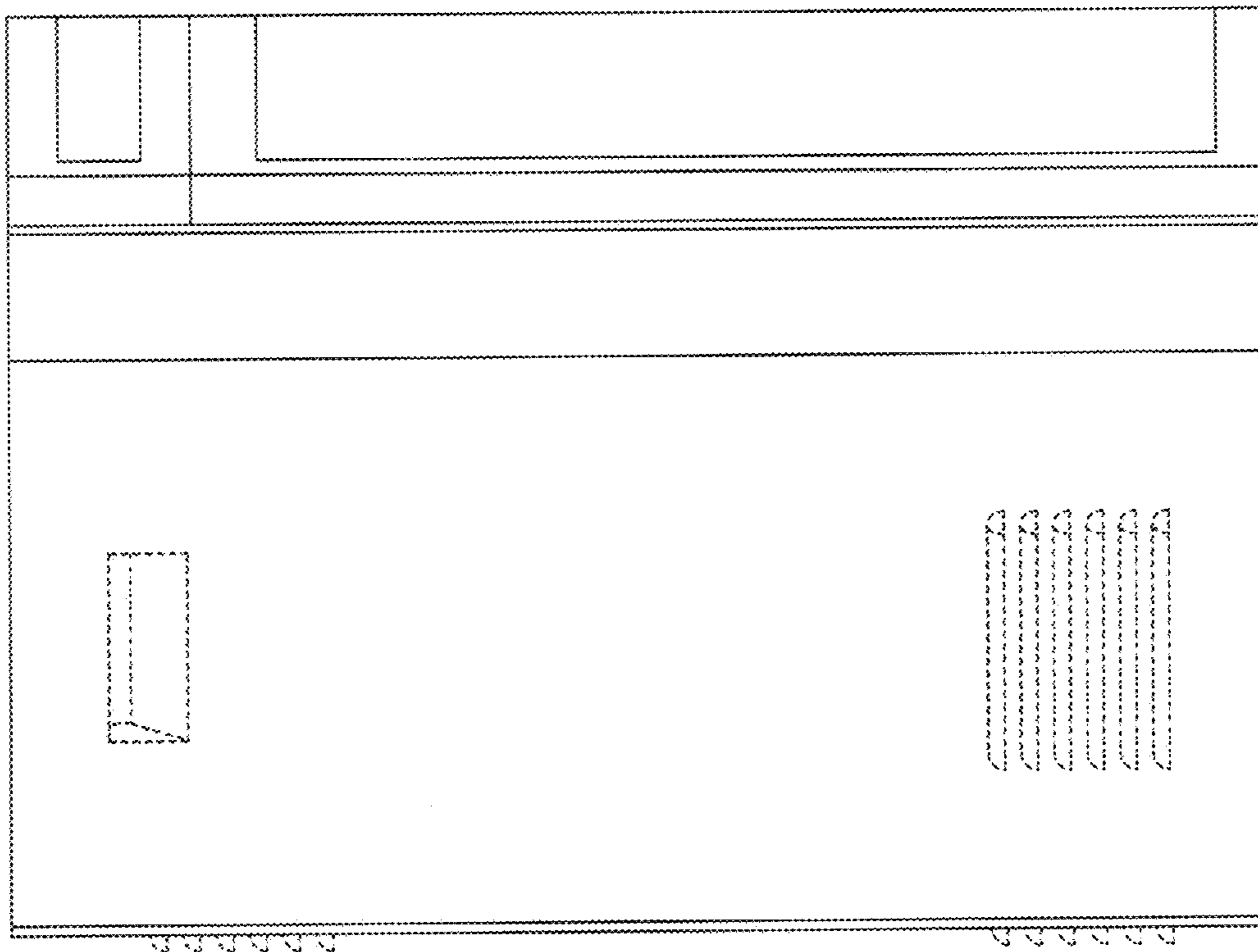

FIG. 21

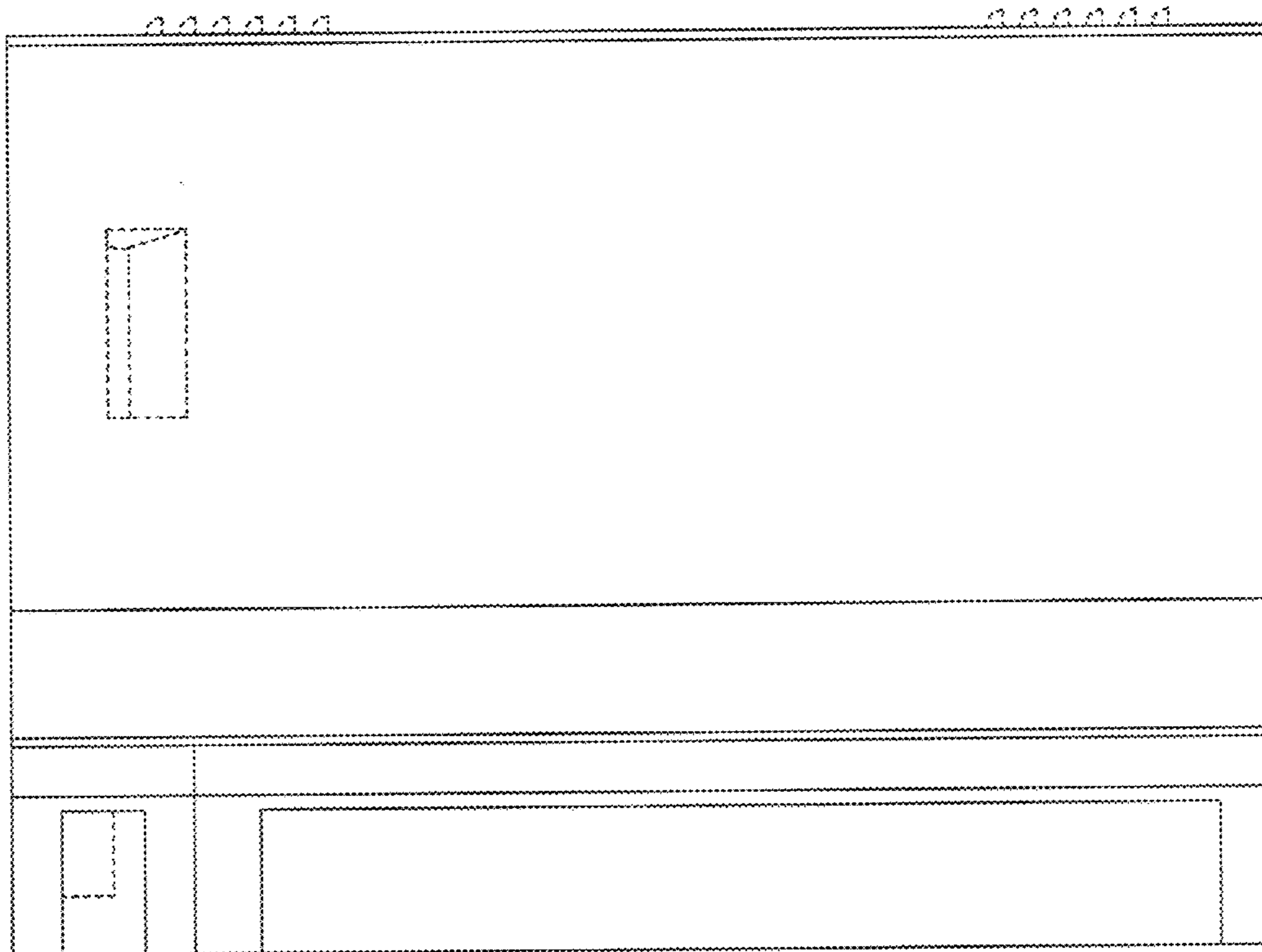

FIG. 22

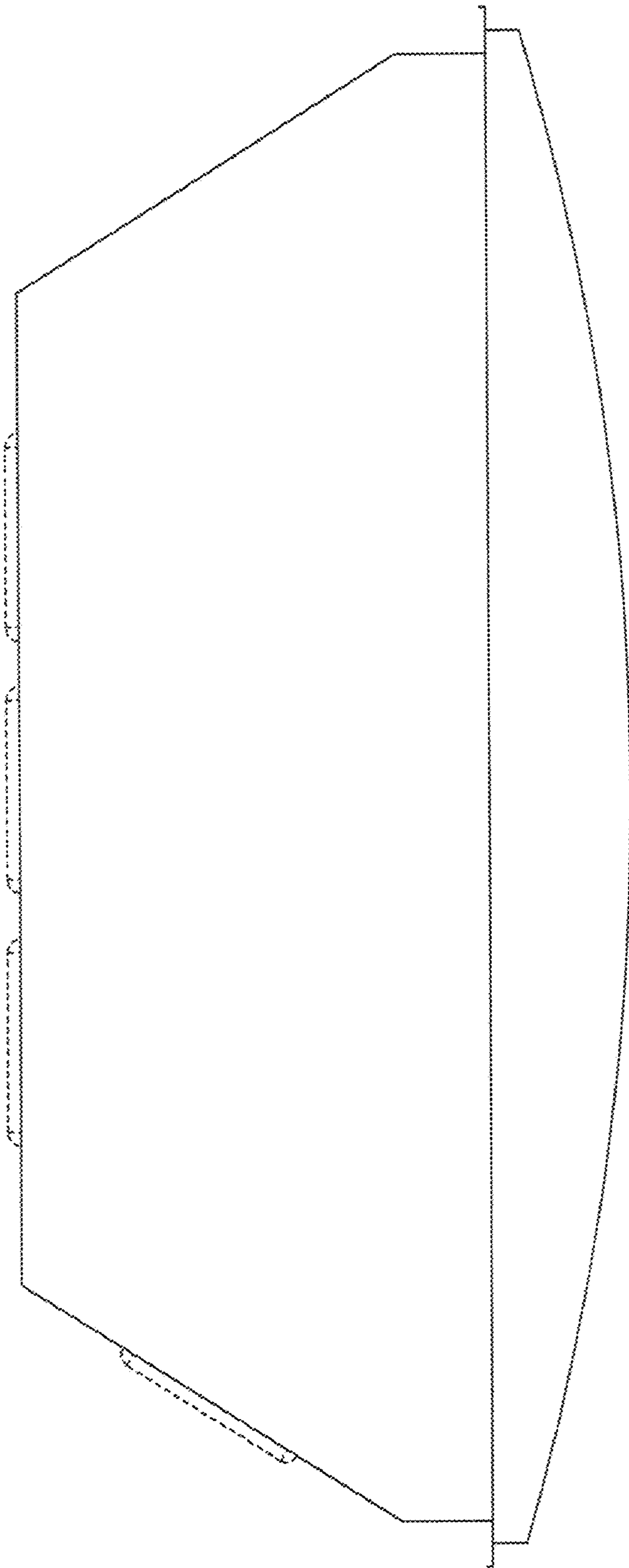

FIG. 23

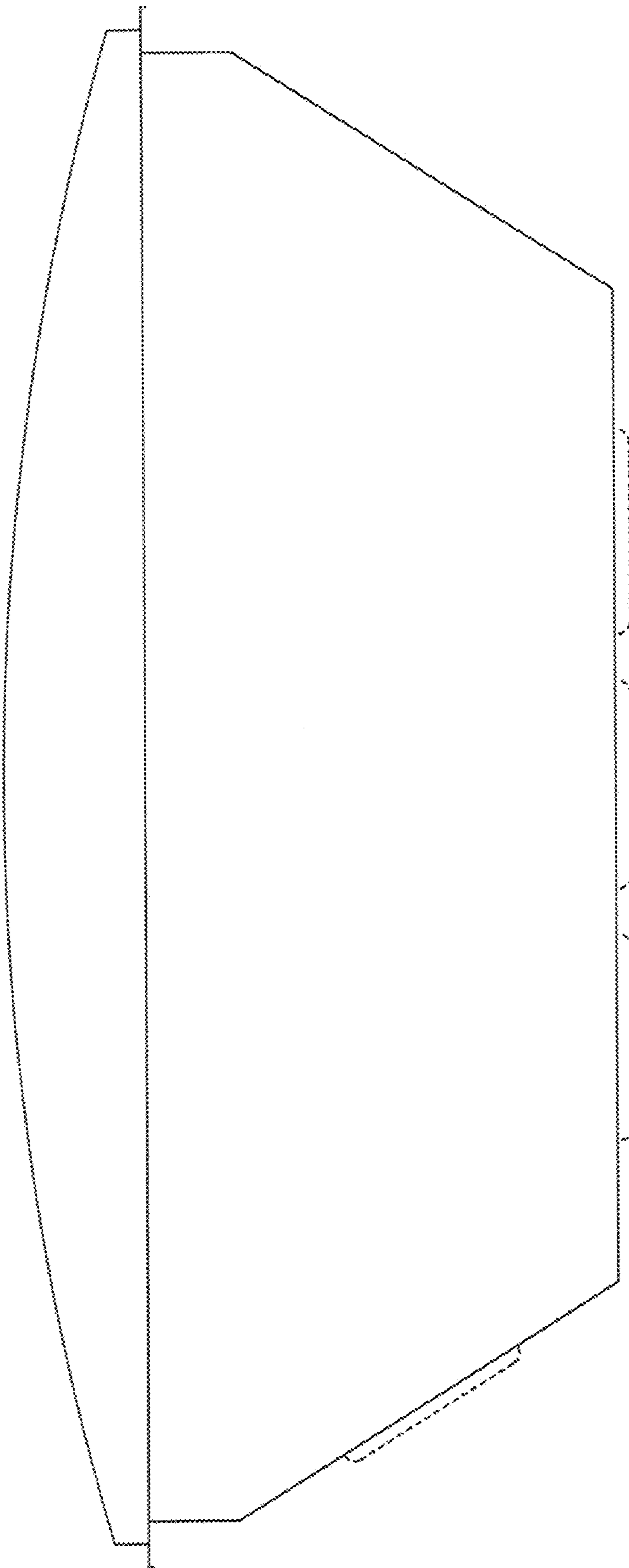

FIG. 24

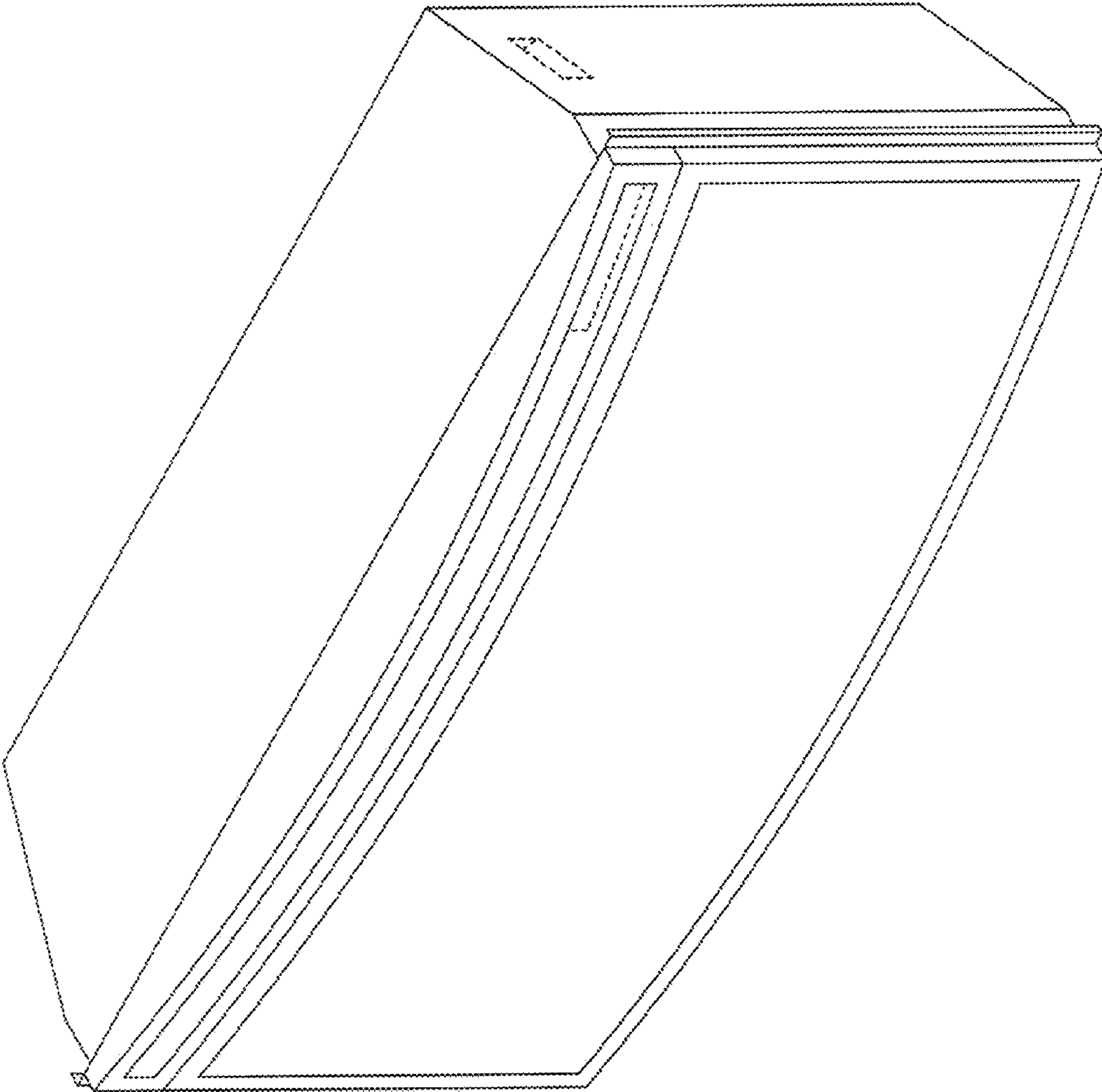

FIG. 25

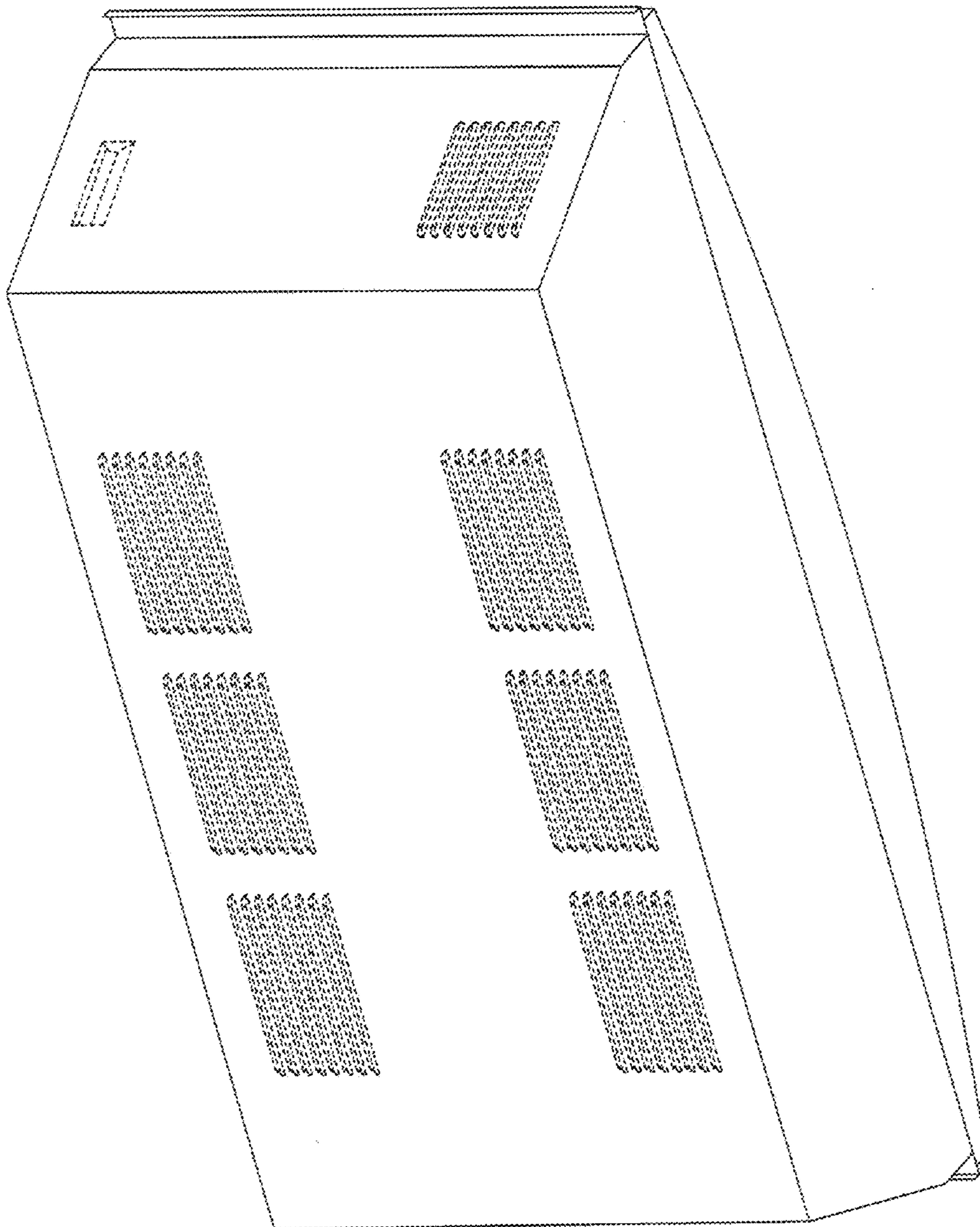

FIG. 26

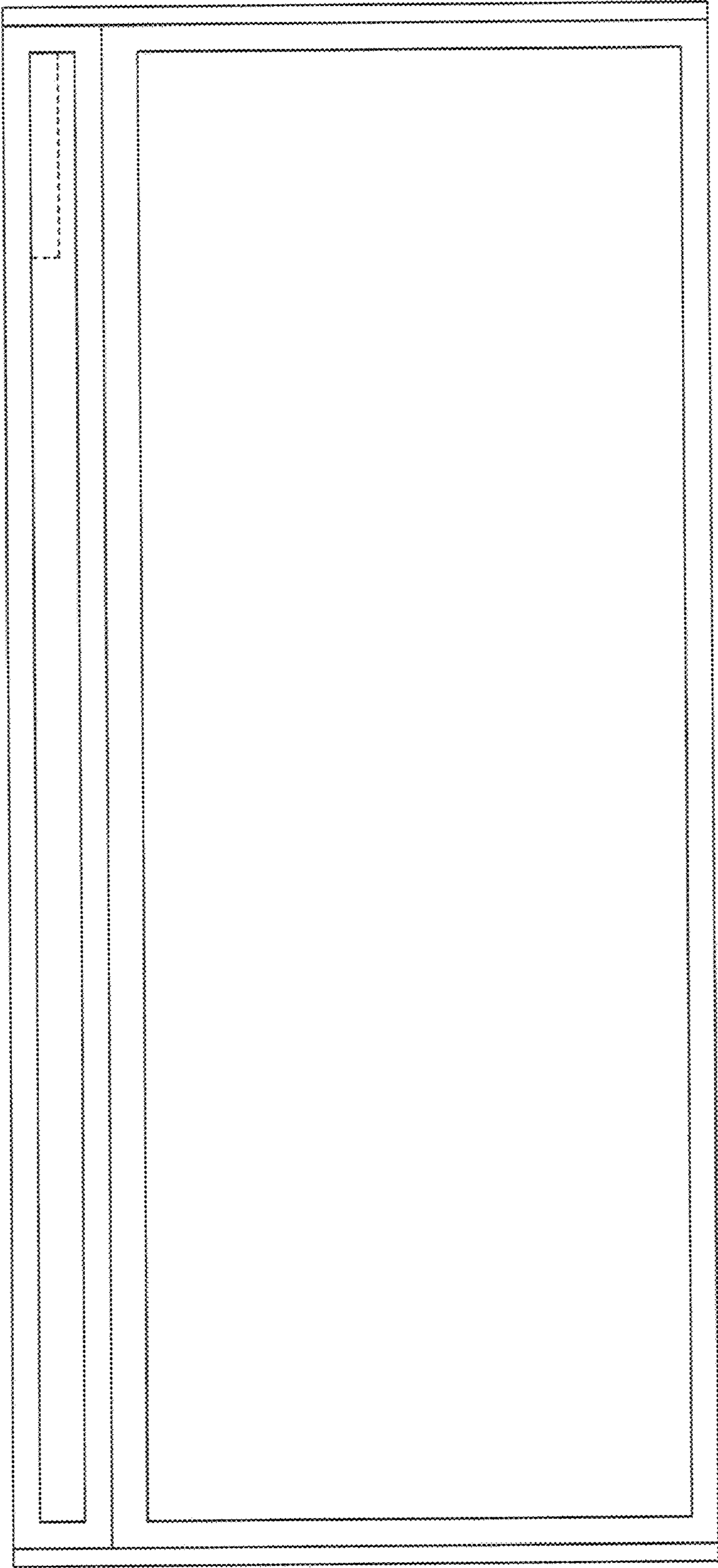

FIG. 27

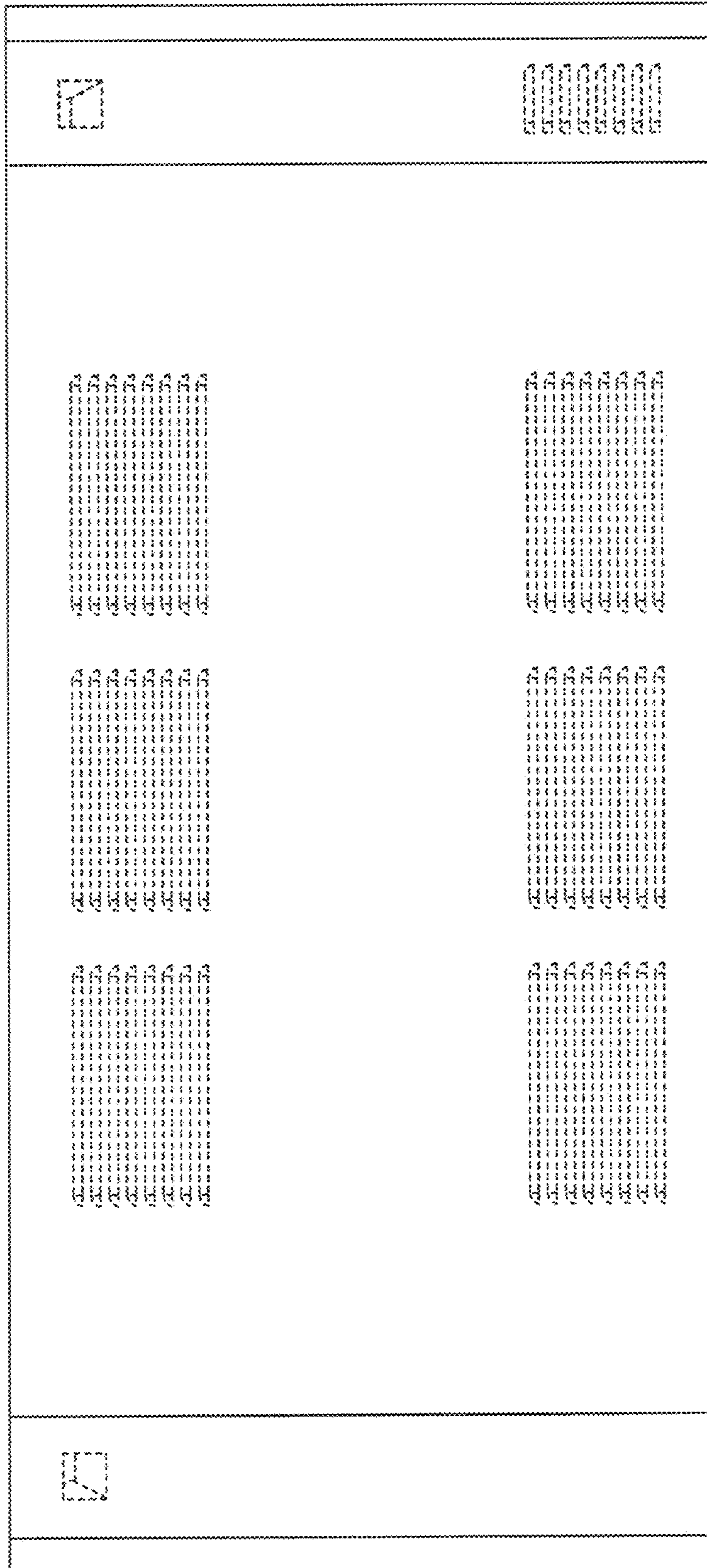

FIG. 28

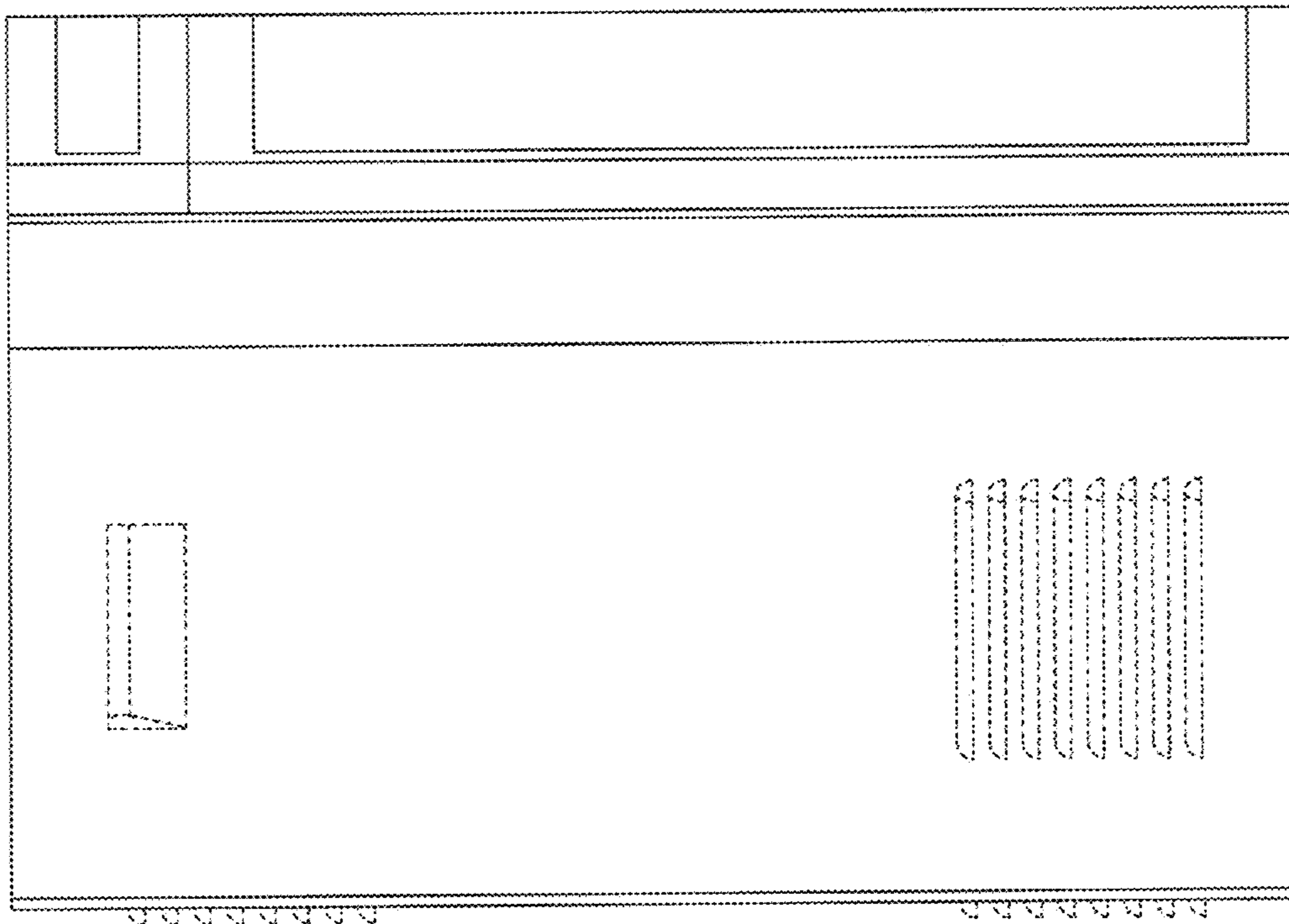

FIG. 29

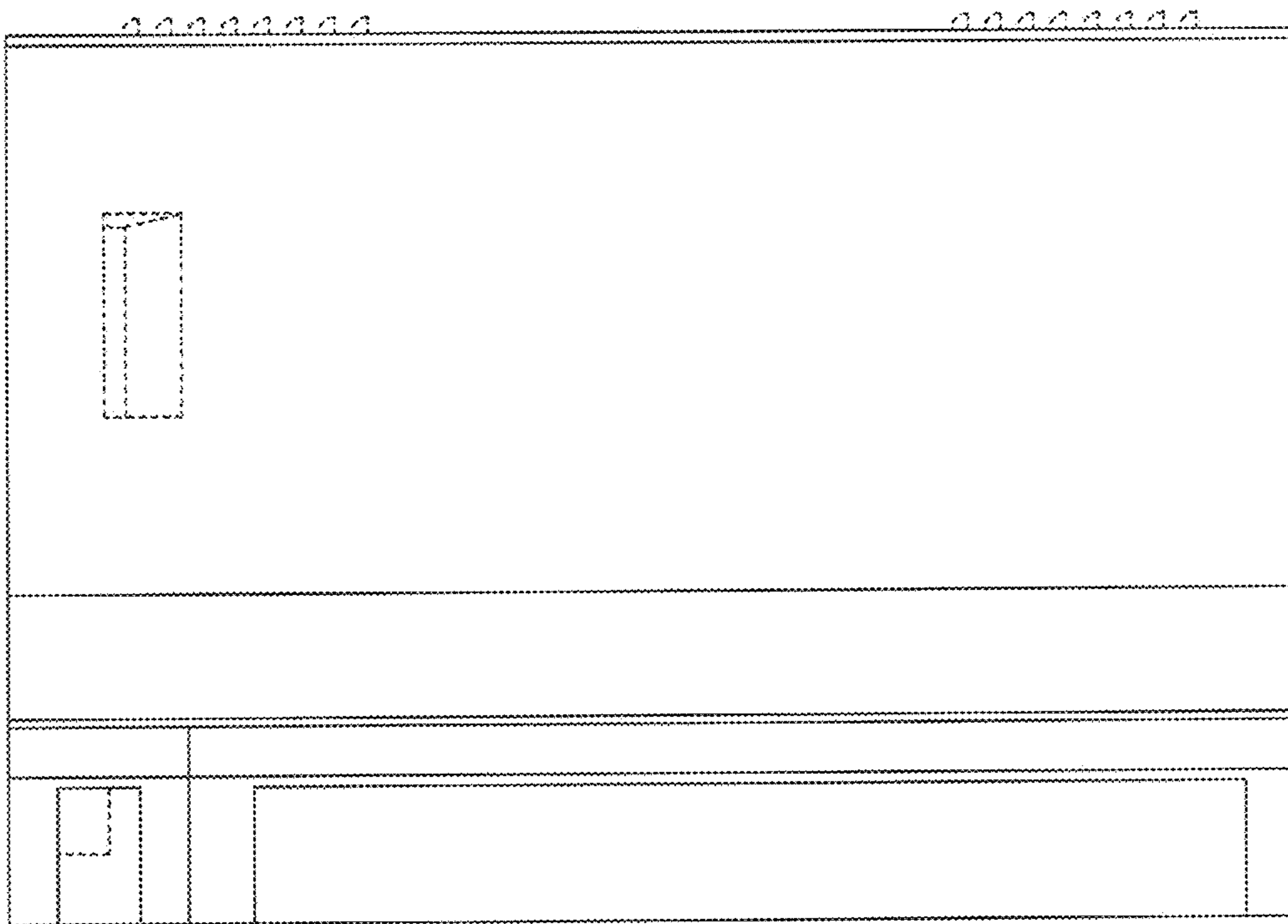

FIG. 30

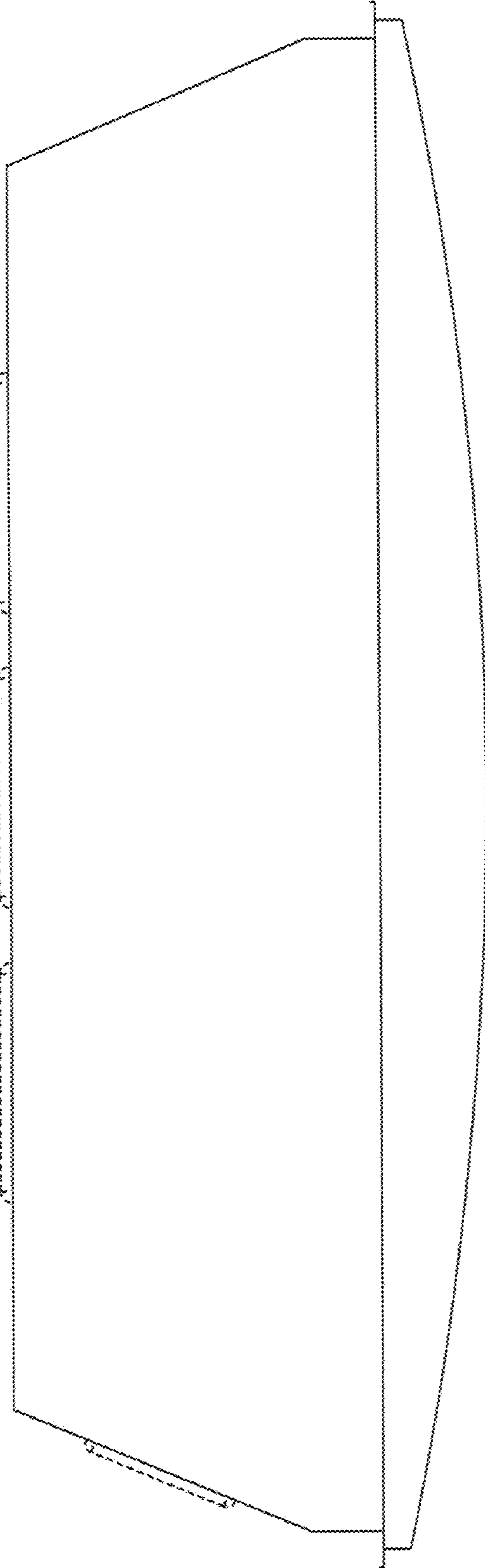

FIG. 31

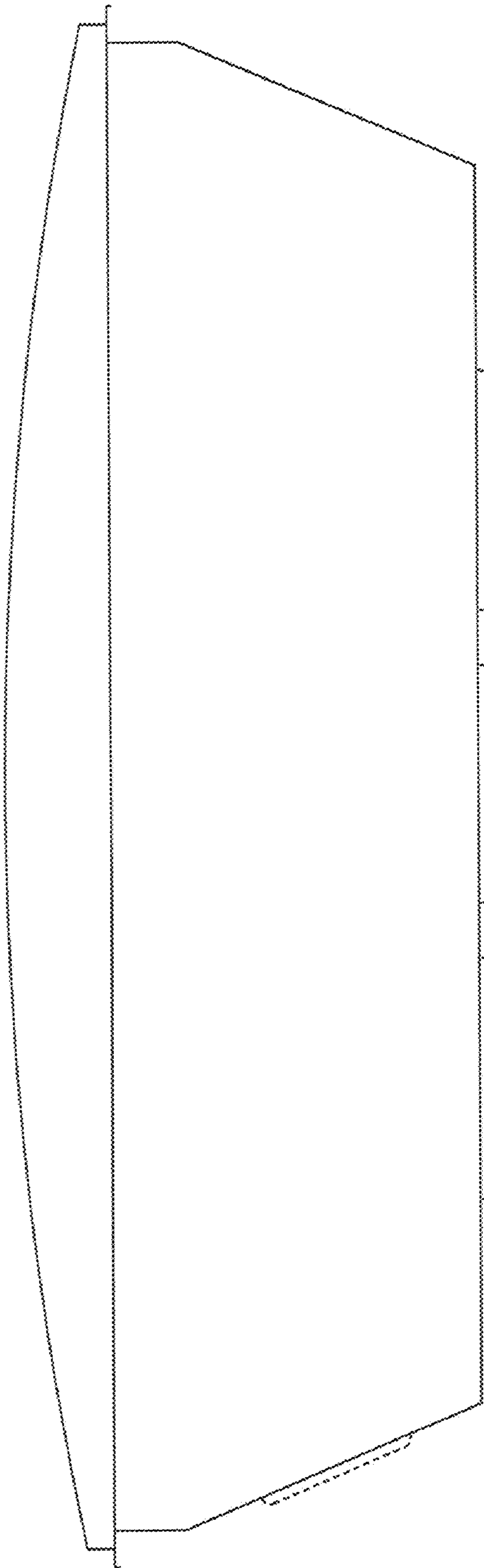

FIG. 32

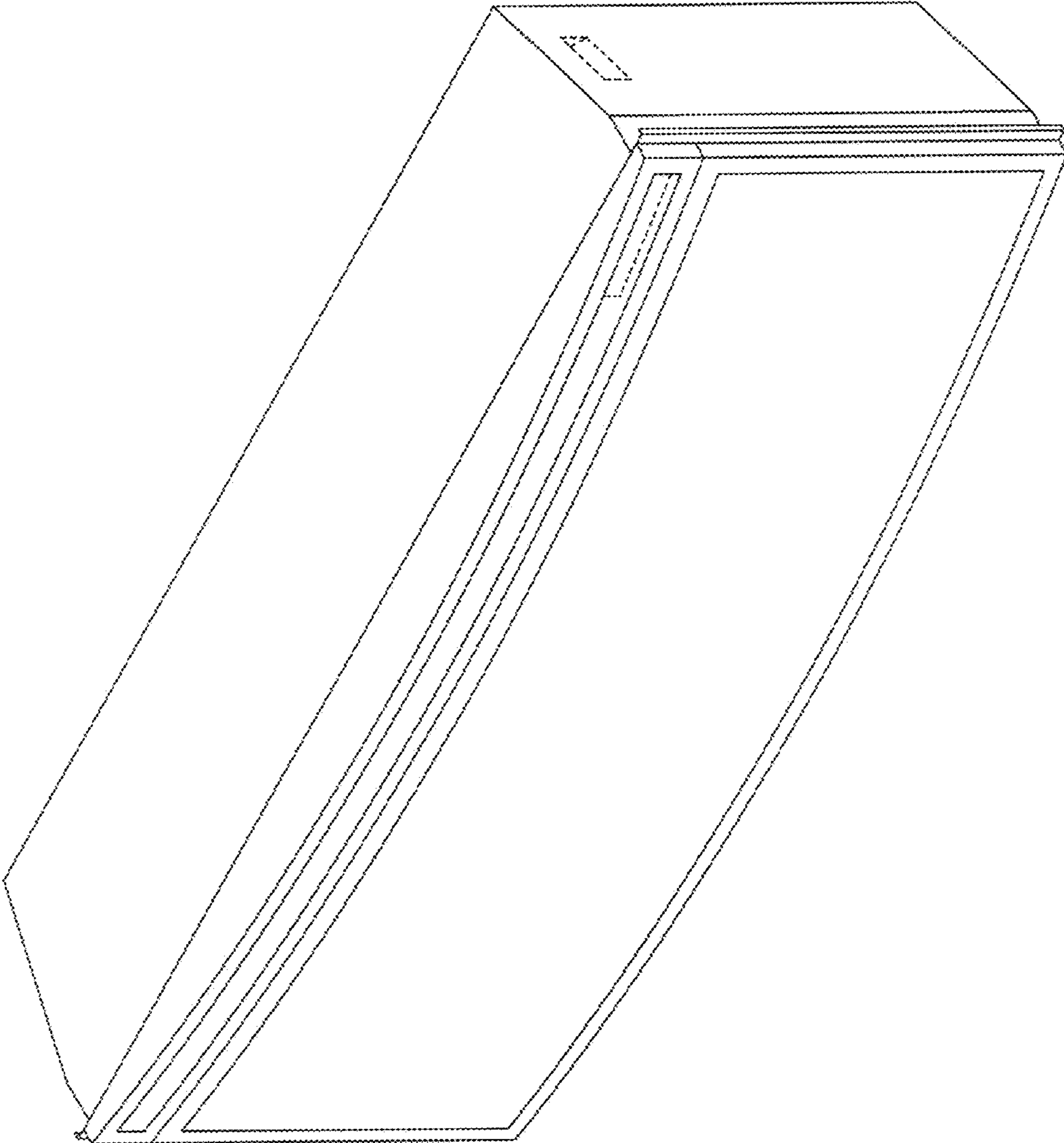

FIG. 33

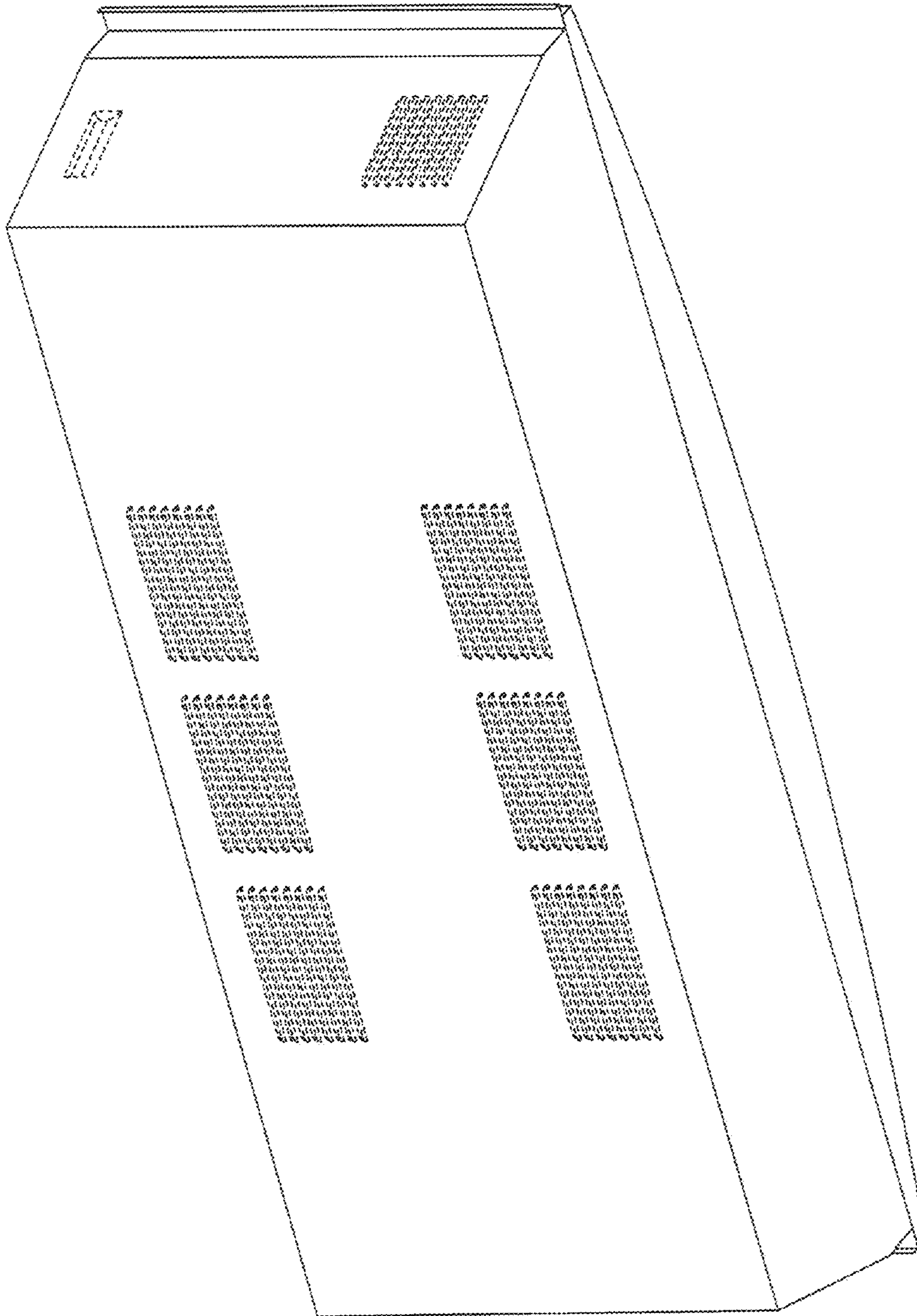

FIG. 34

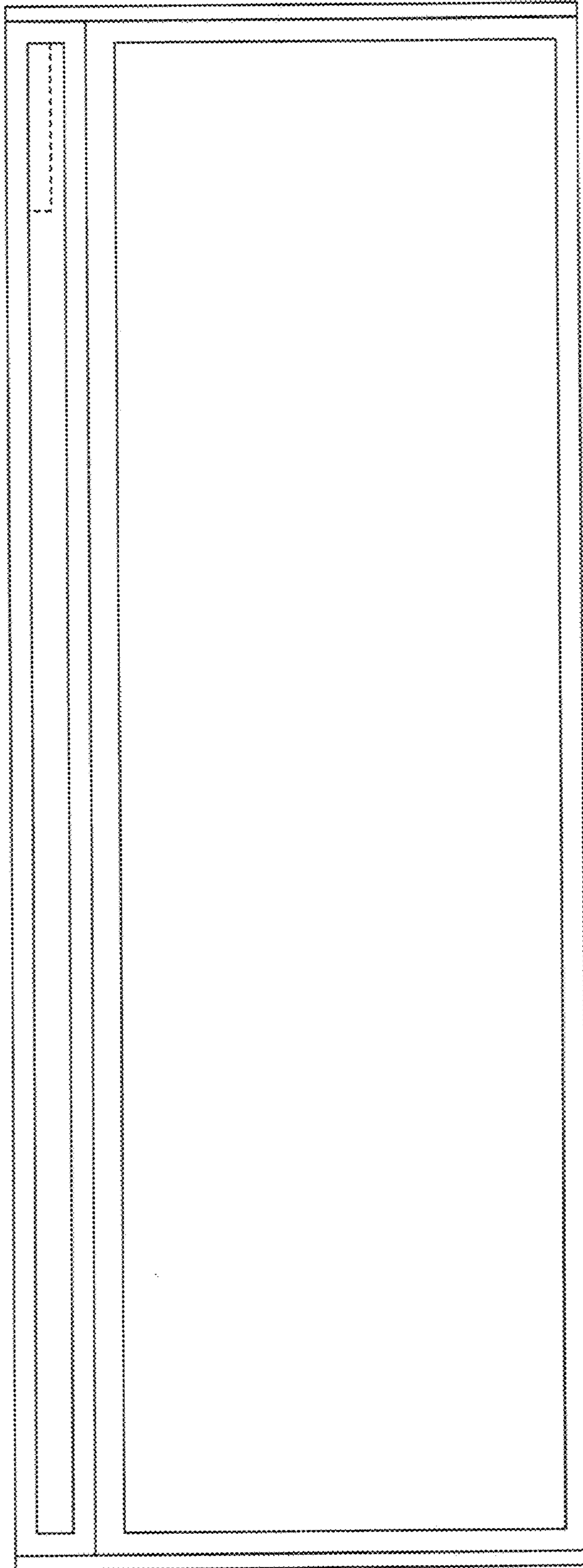

FIG. 35

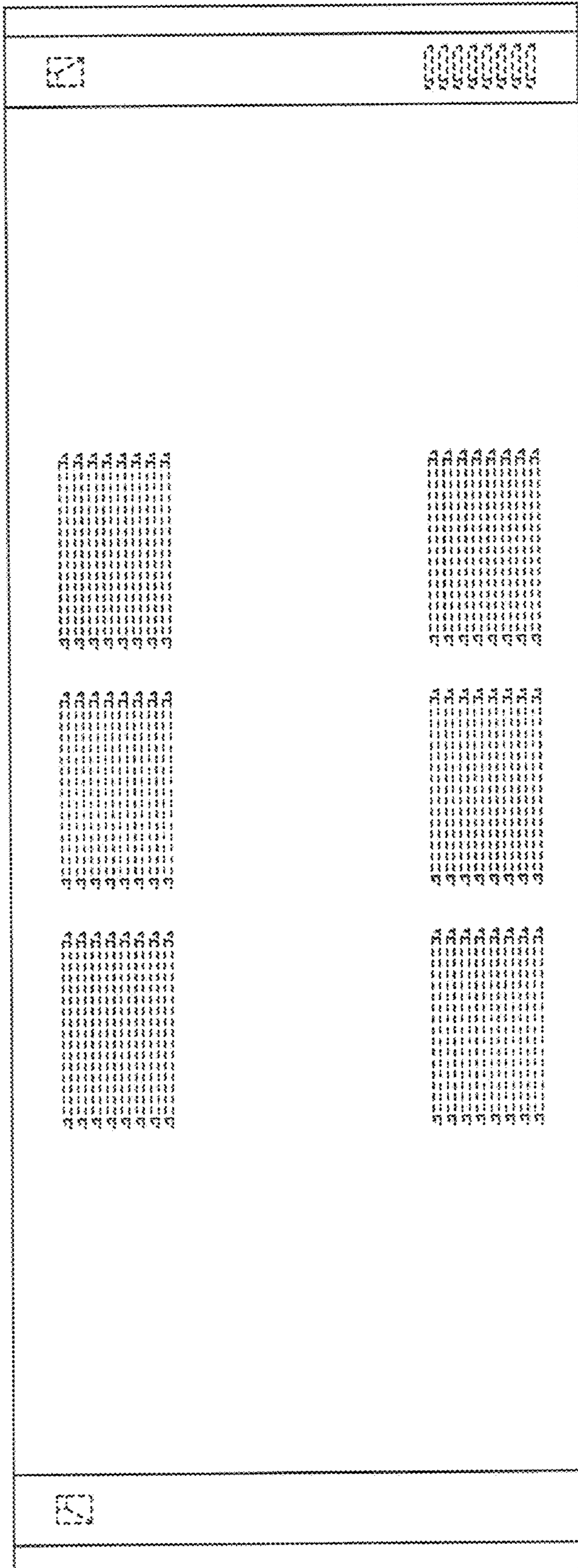

FIG. 36

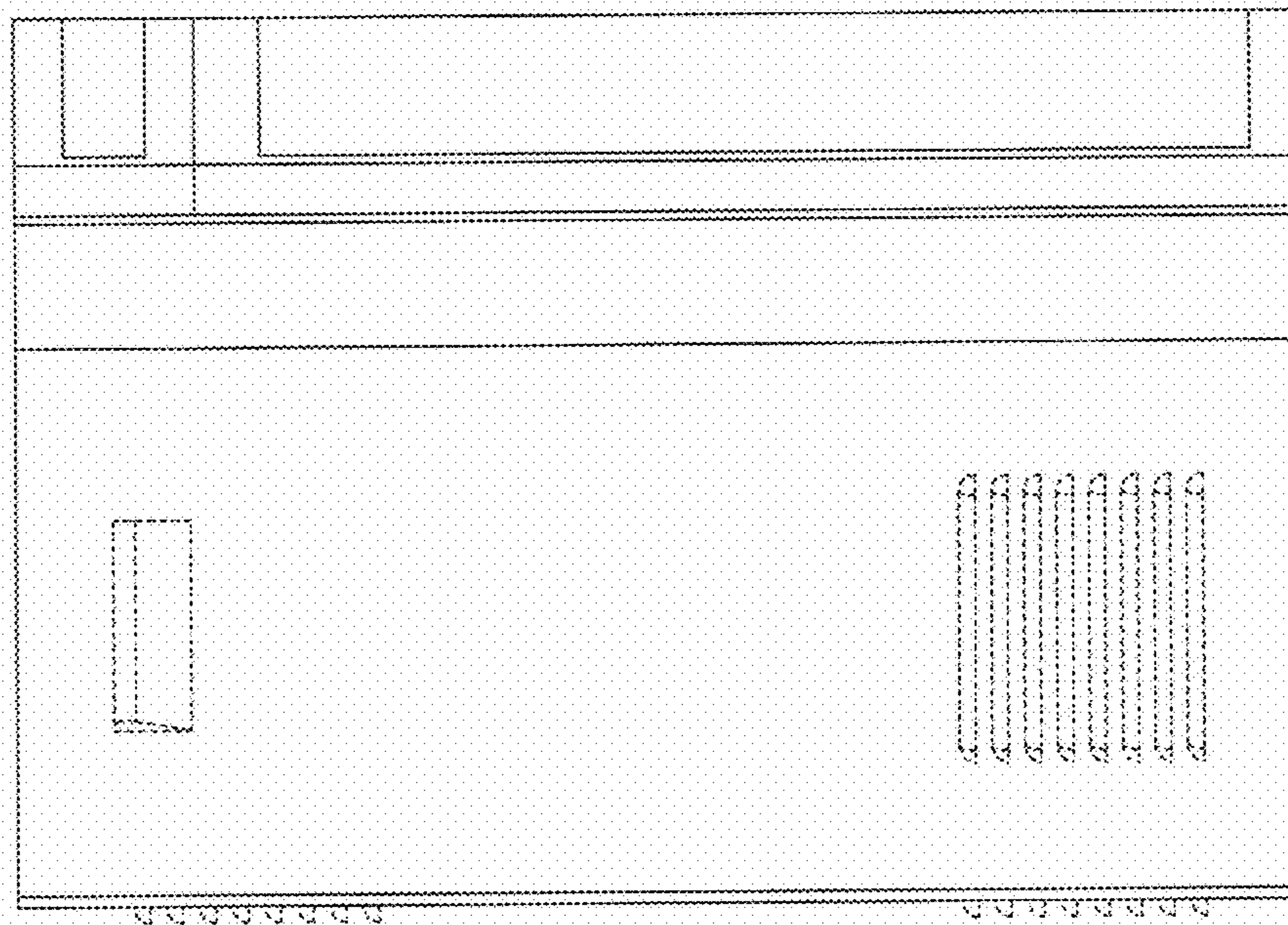

FIG. 37

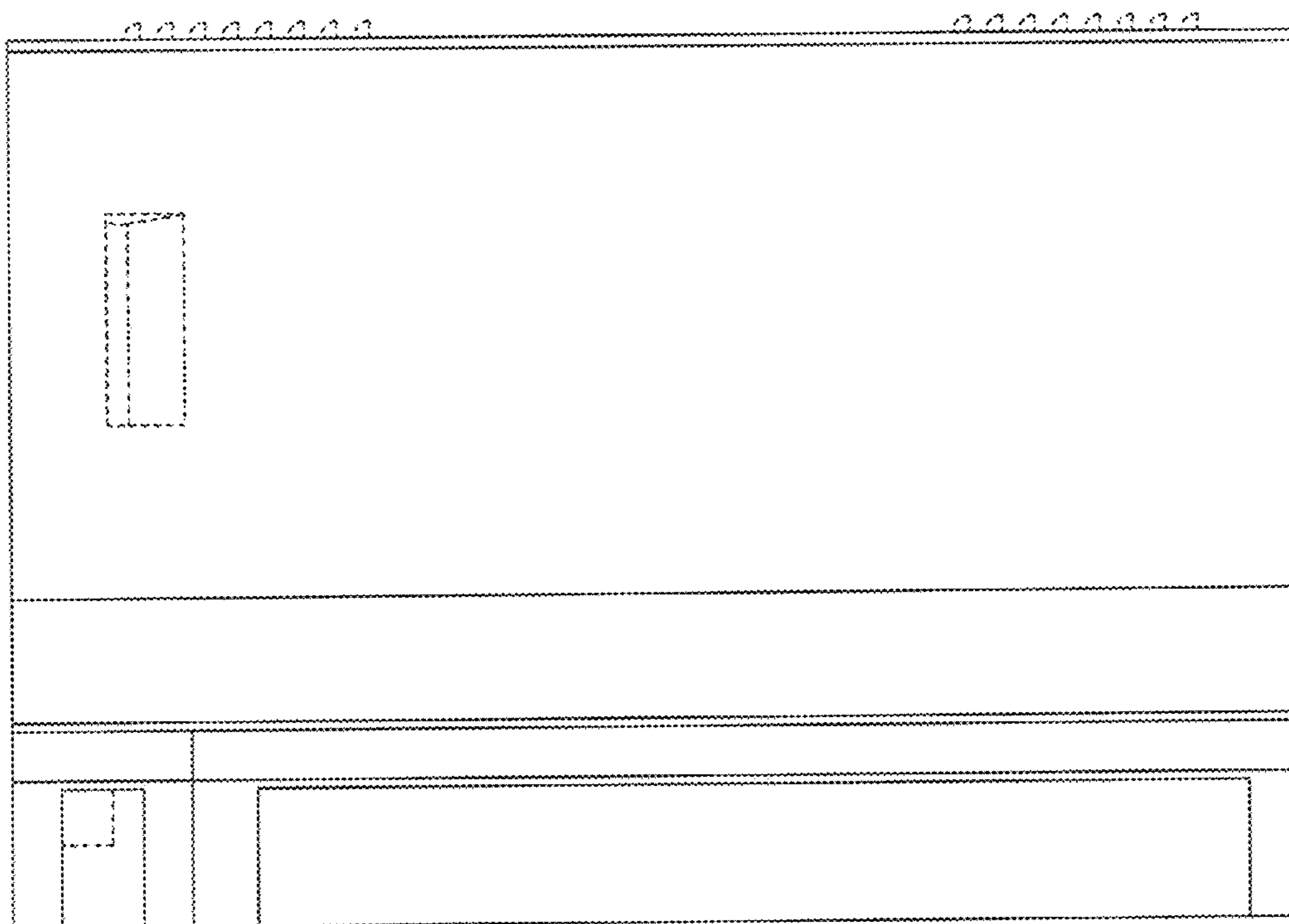

FIG. 38

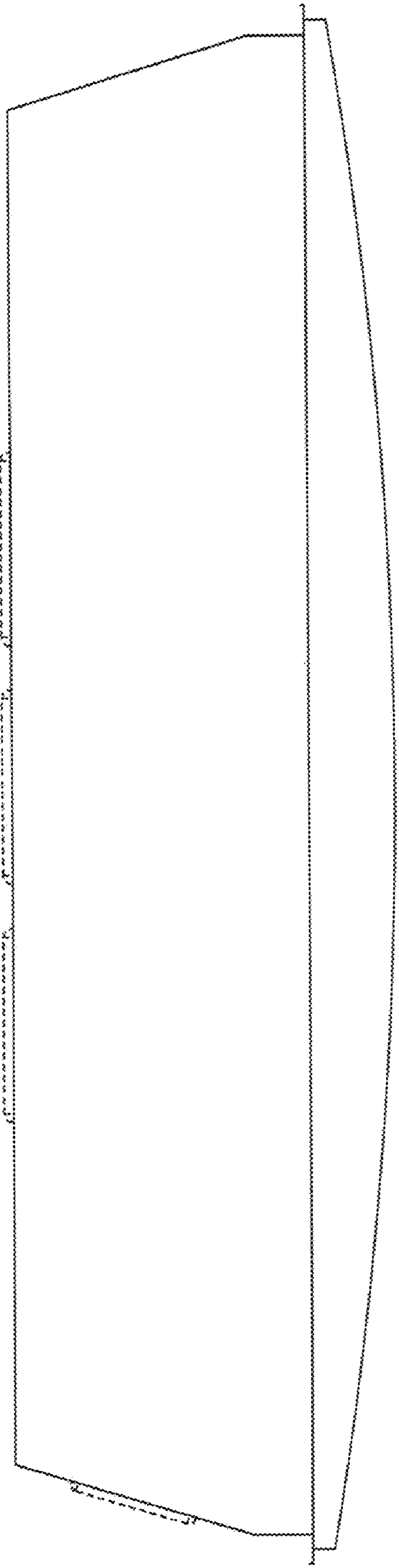

FIG. 39

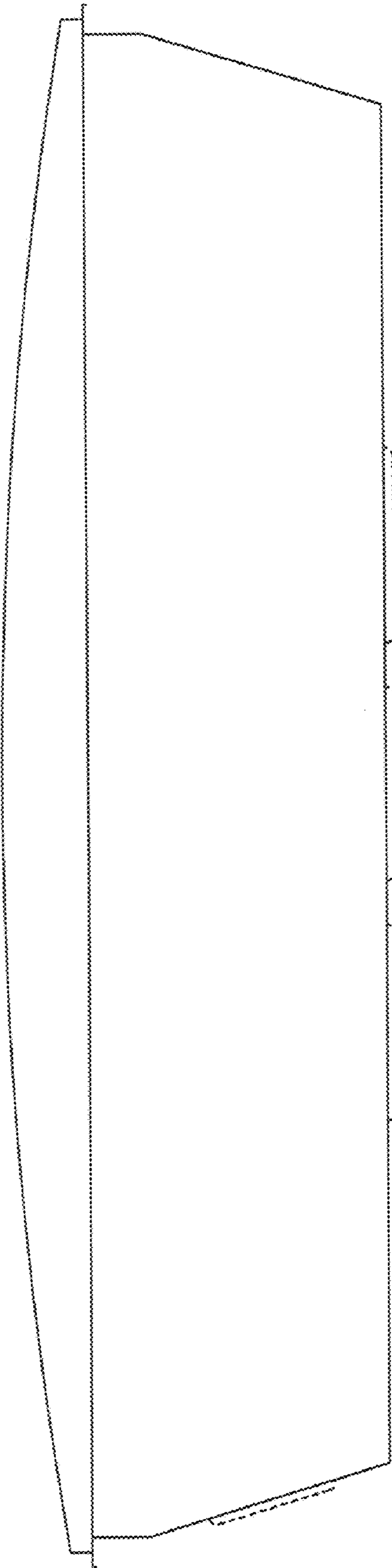

FIG. 40

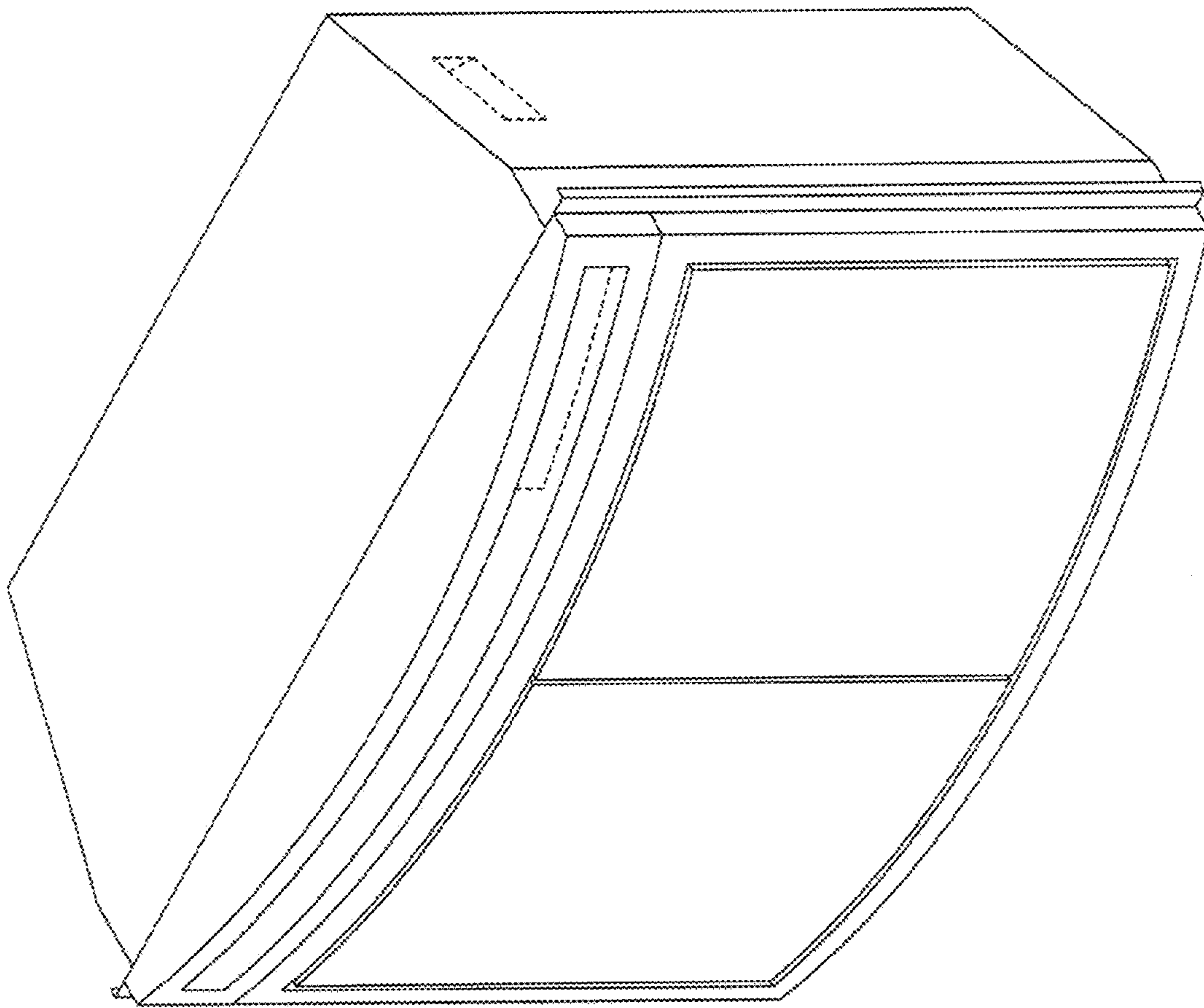

FIG. 41

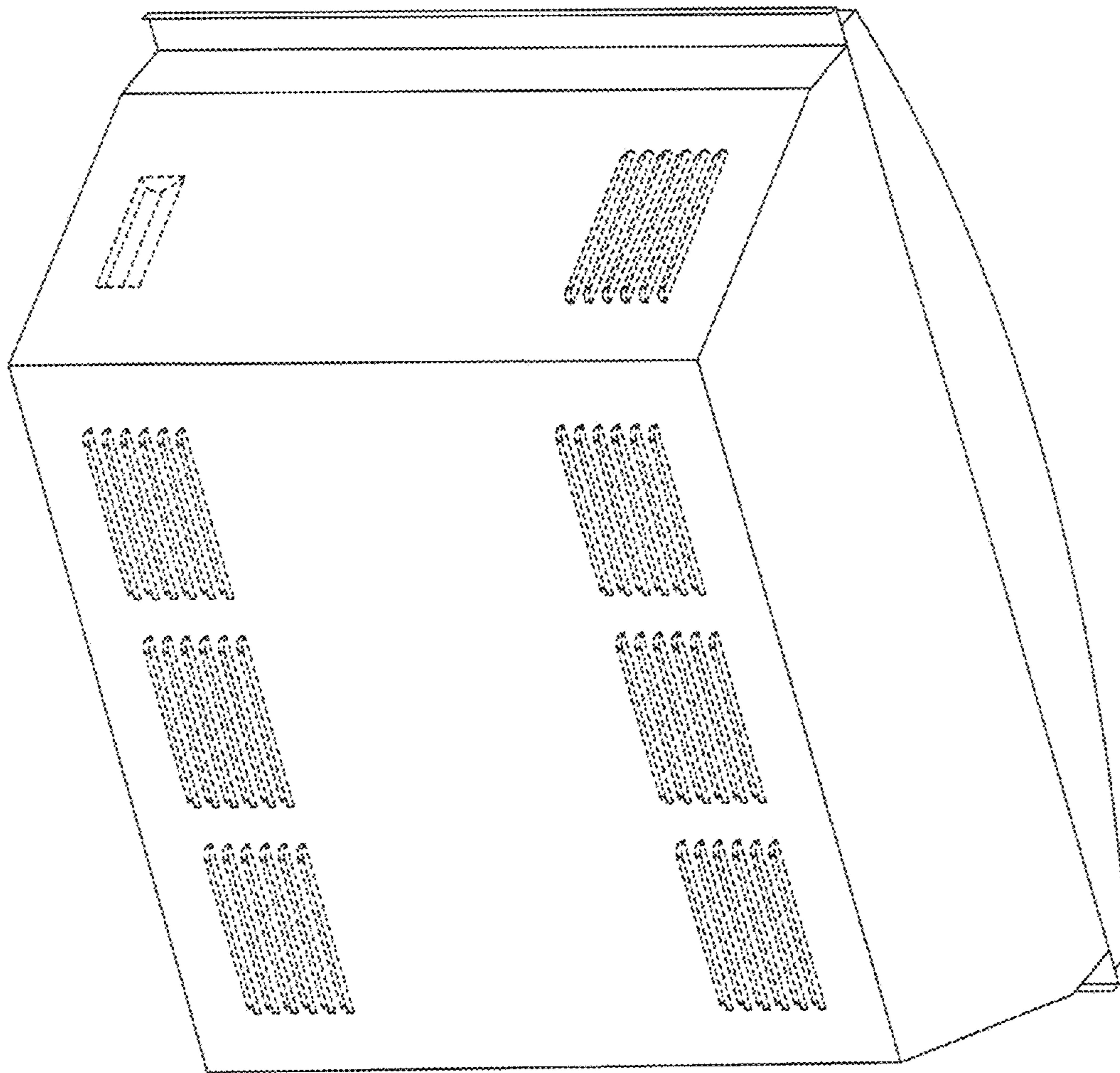

FIG. 42

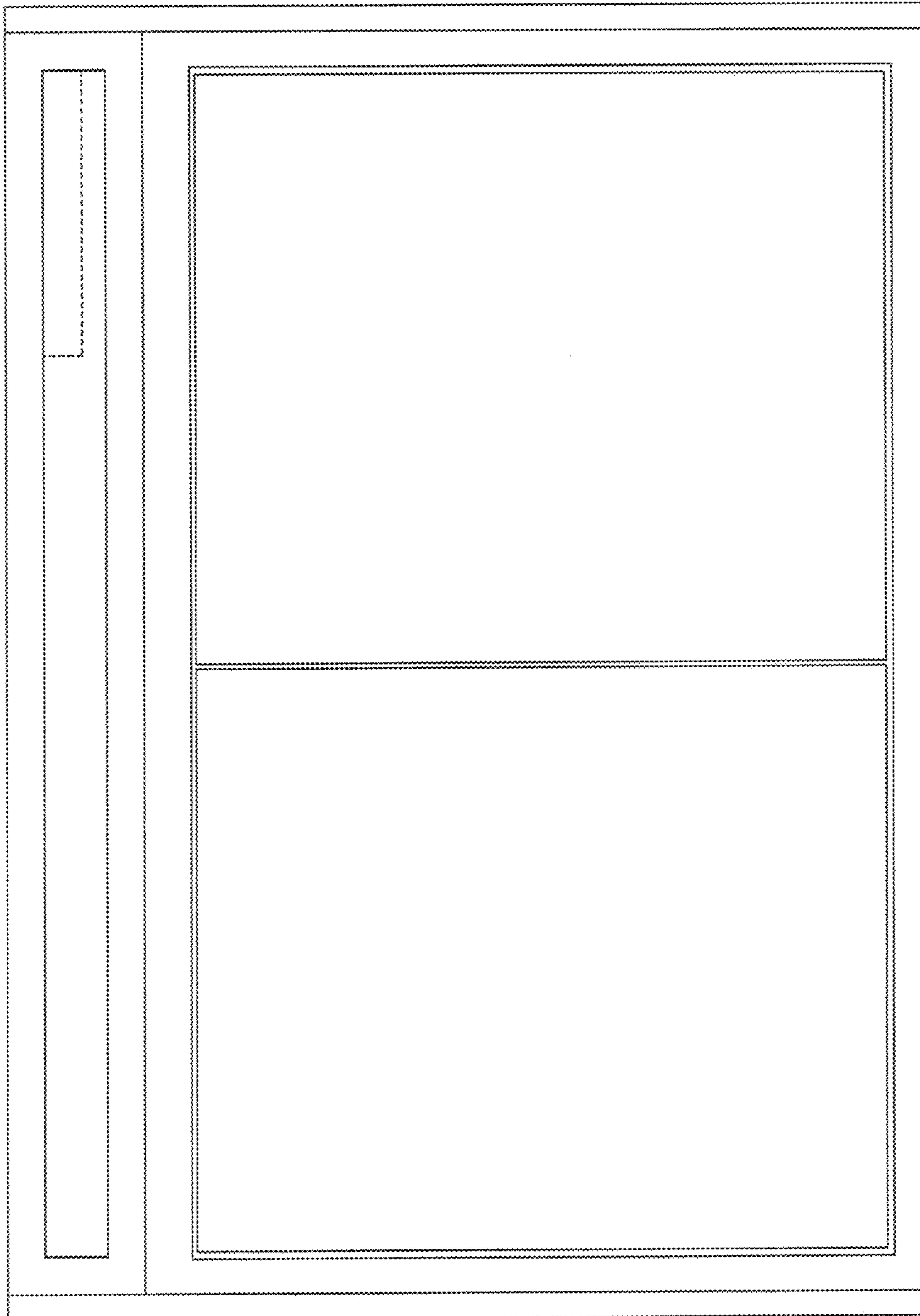

FIG. 43

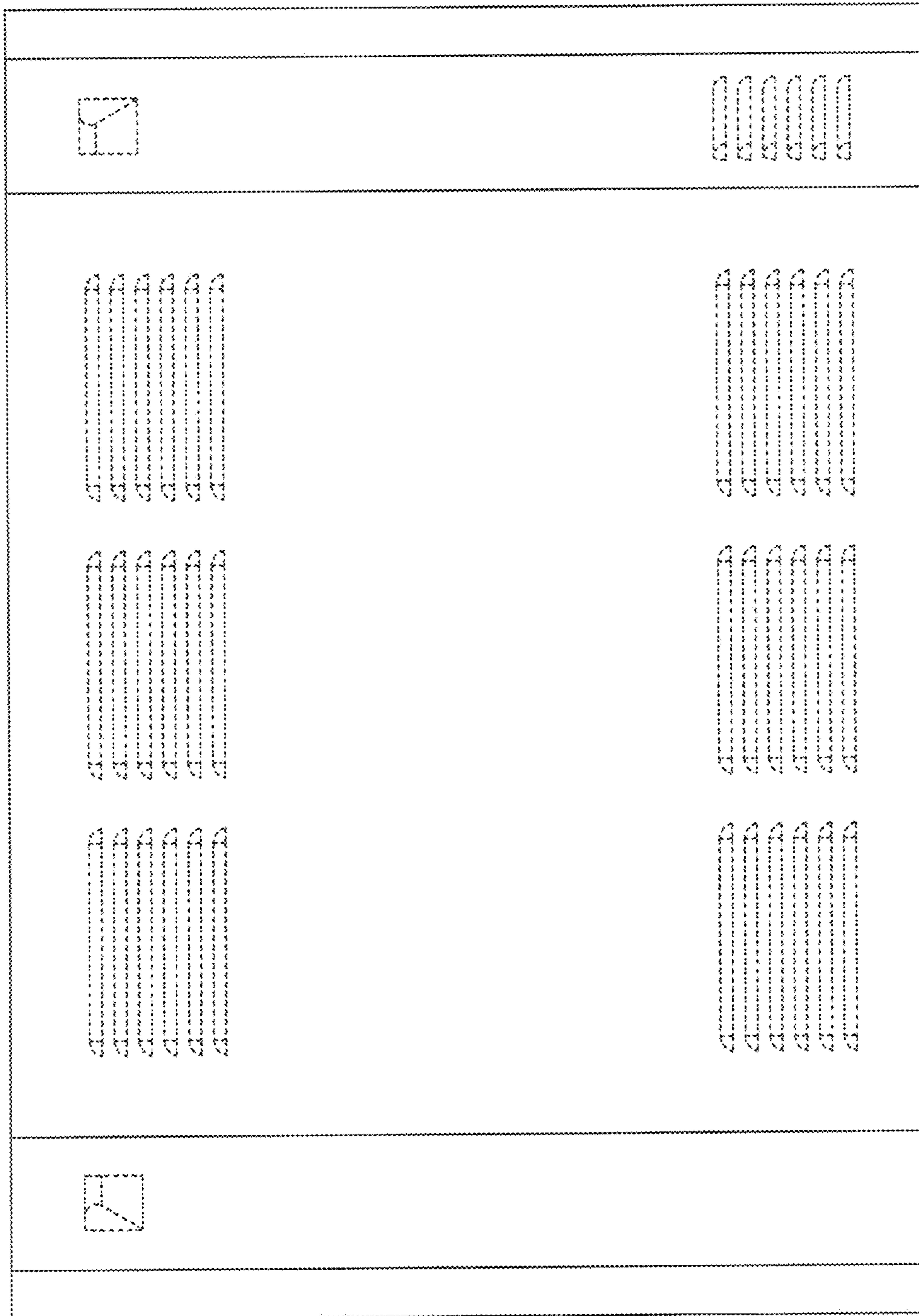

FIG. 44

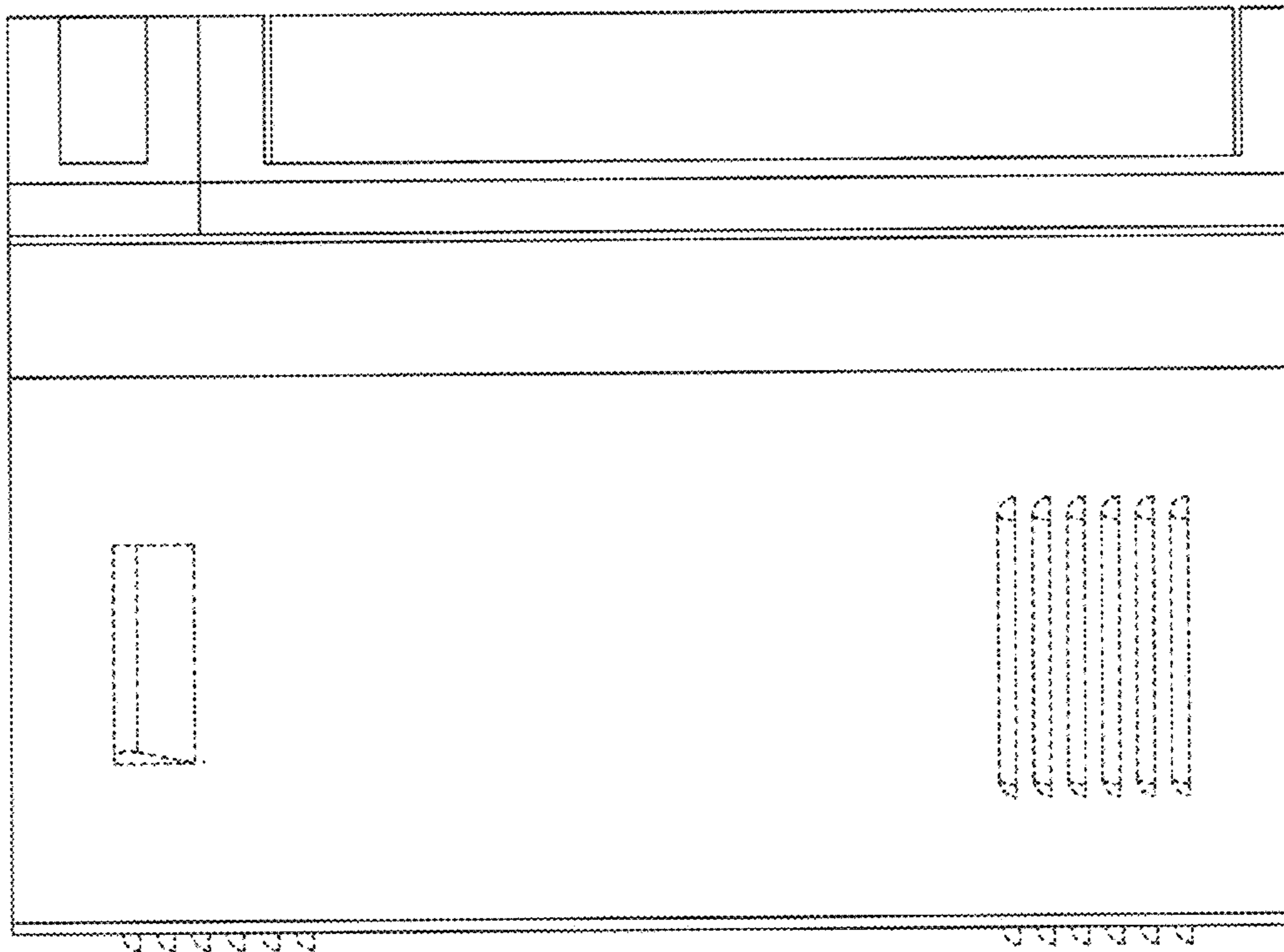

FIG. 45

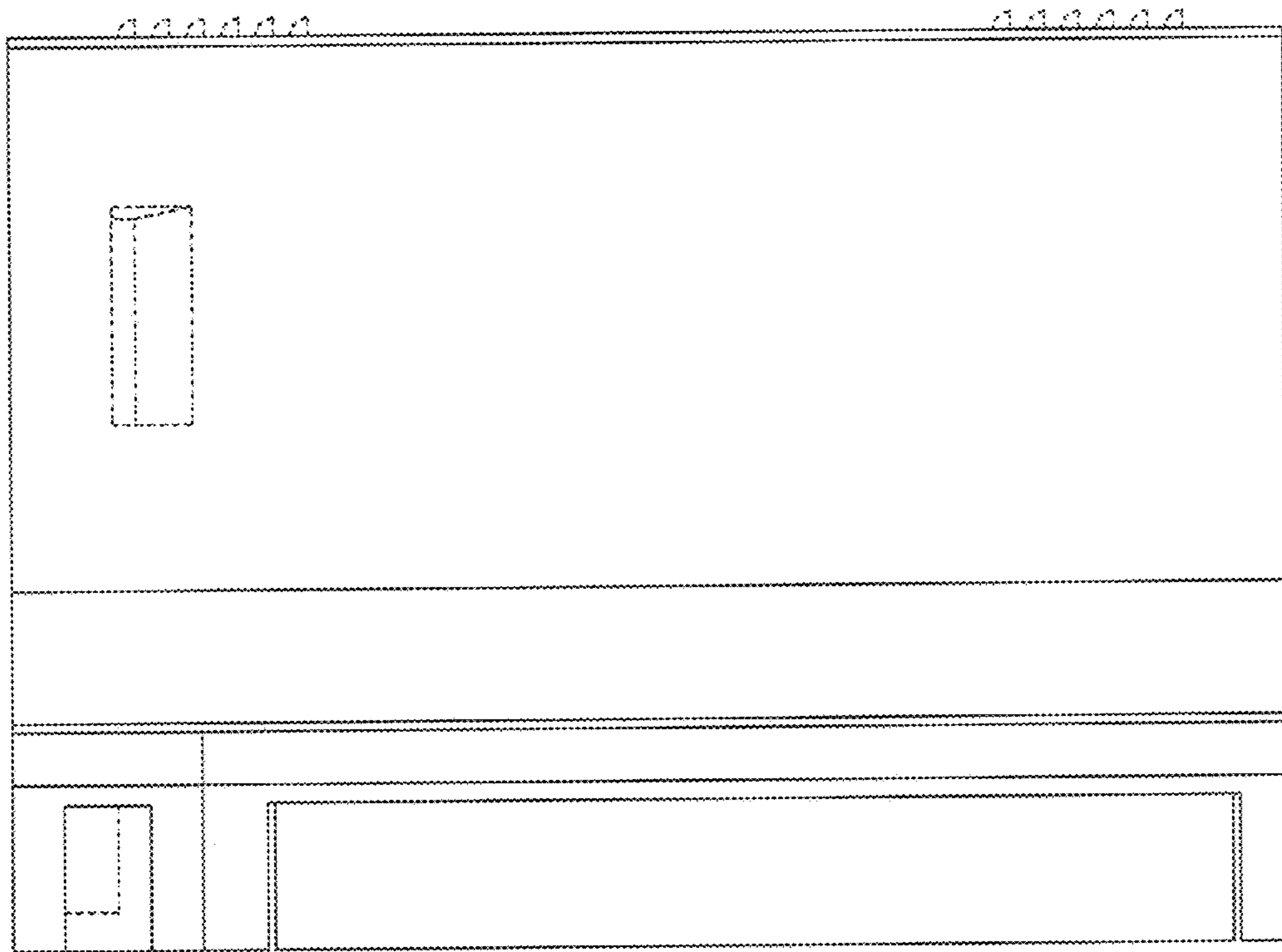

FIG. 46

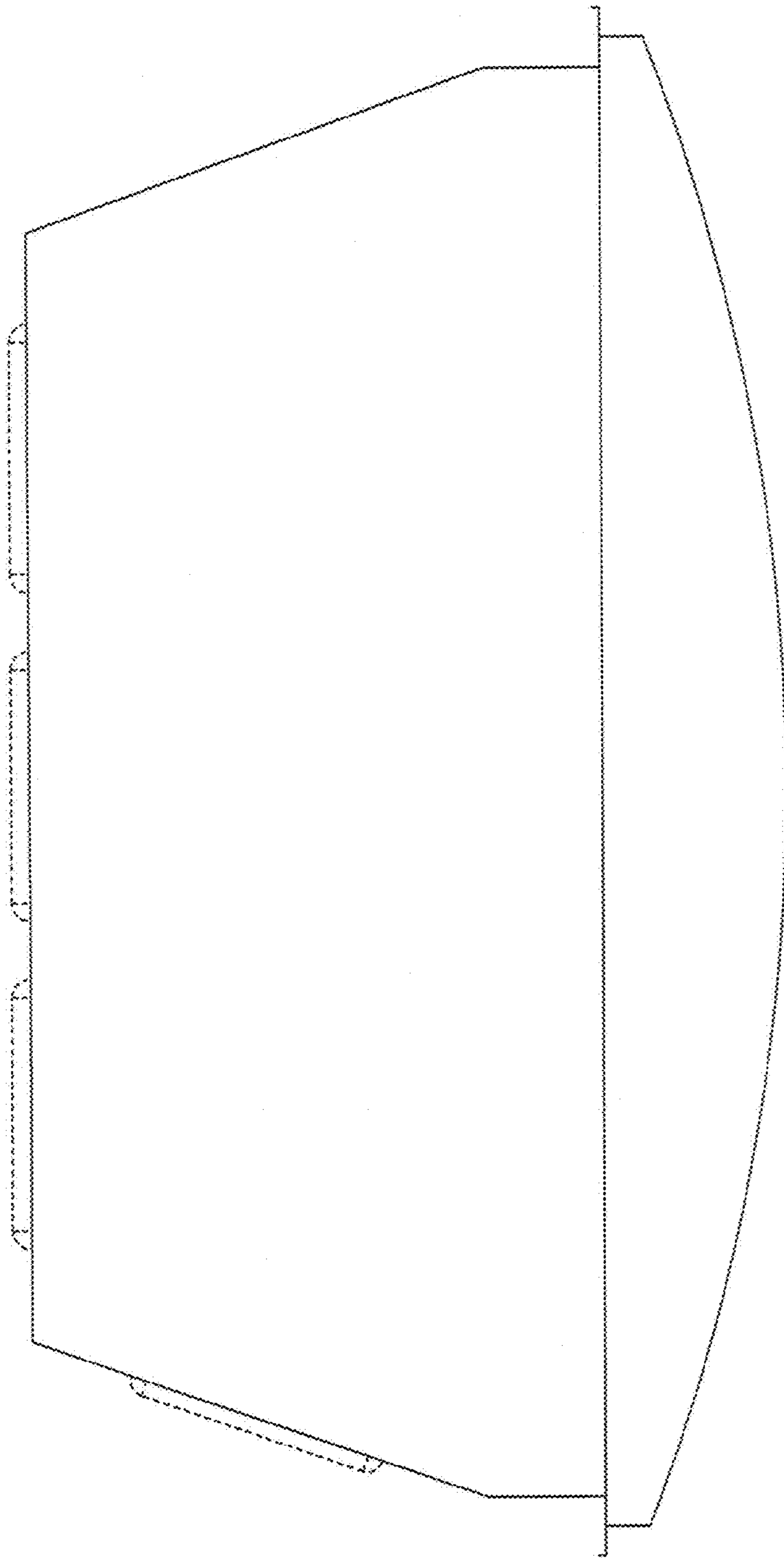

FIG. 47

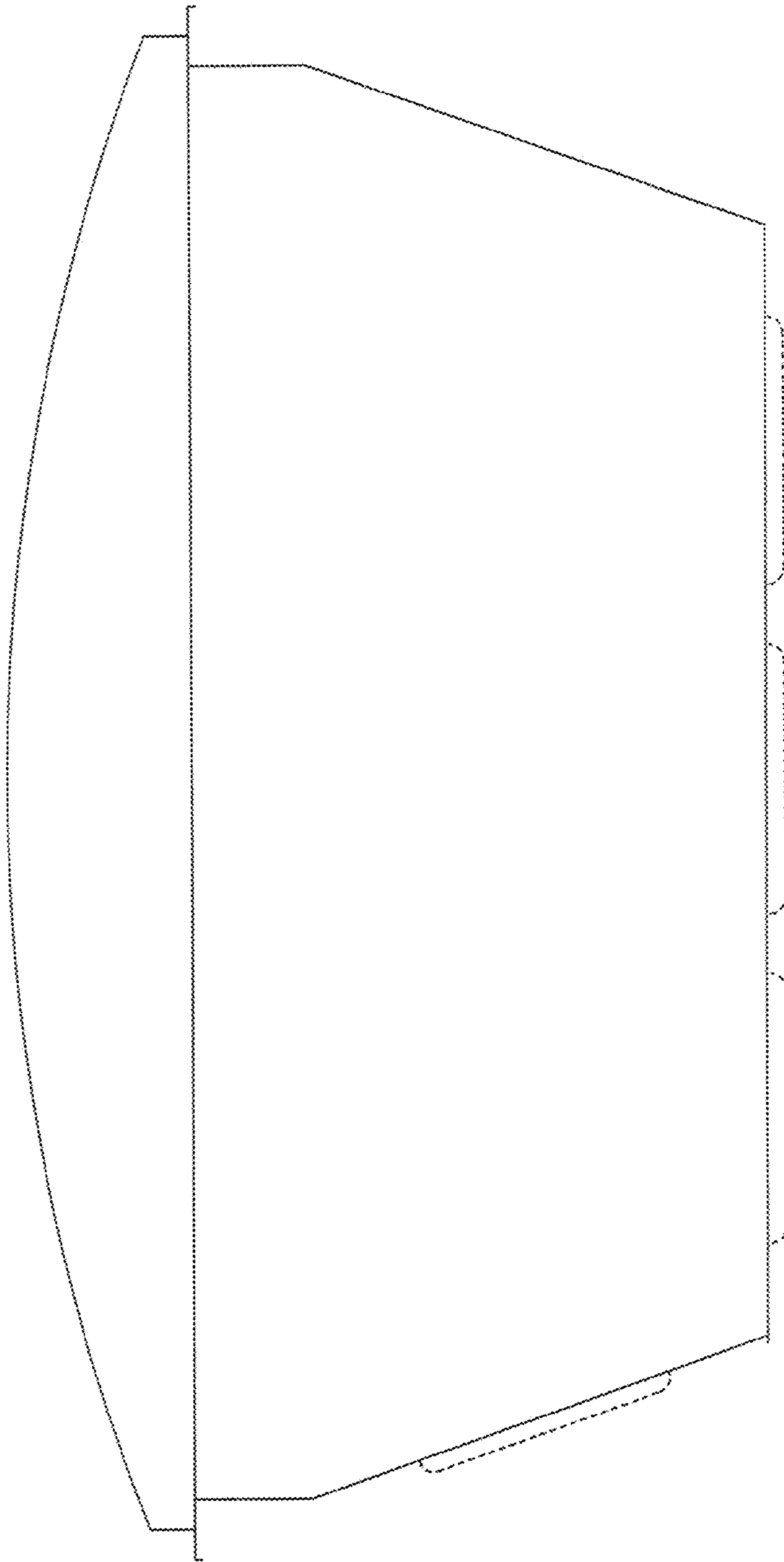

FIG. 48

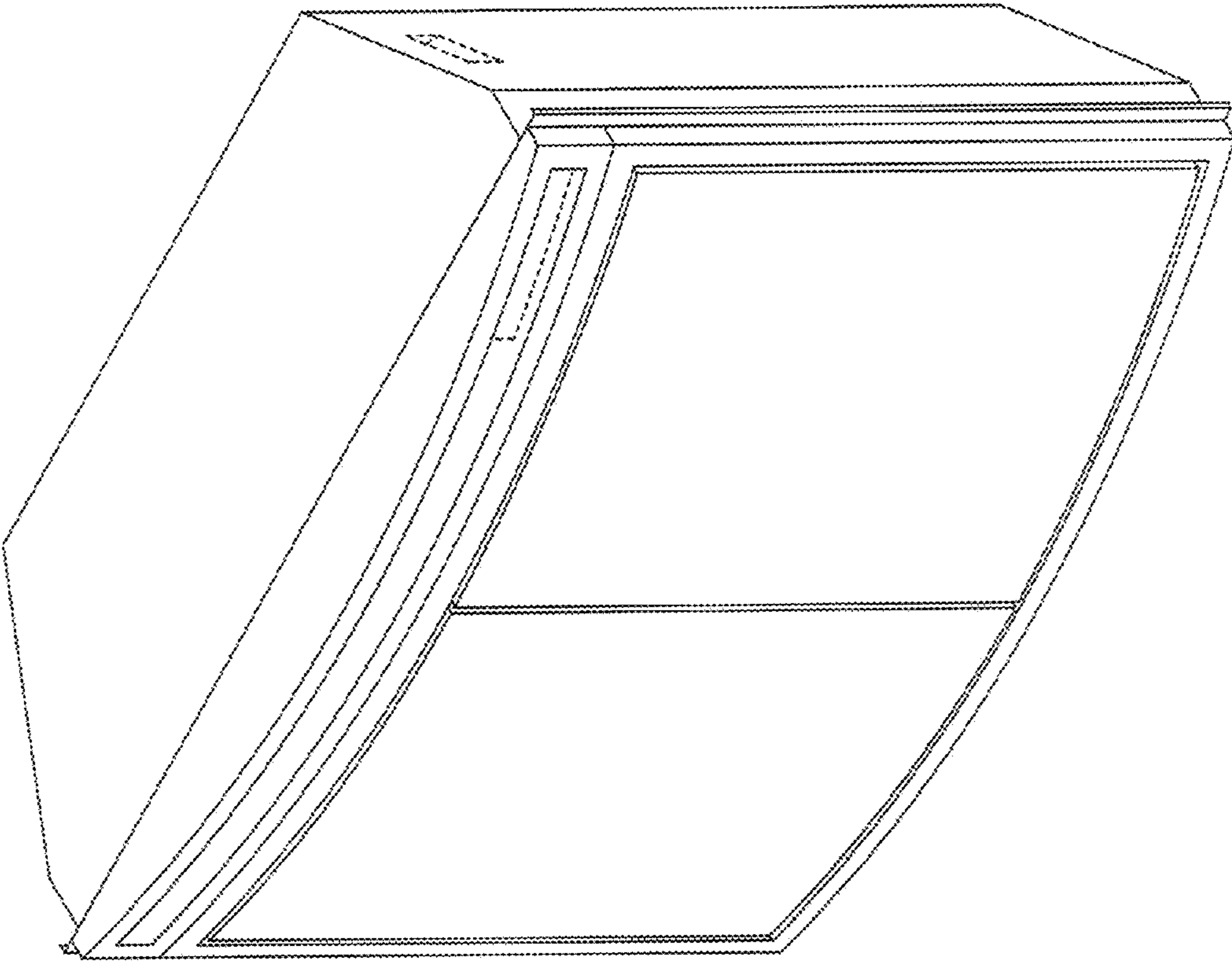

FIG. 49

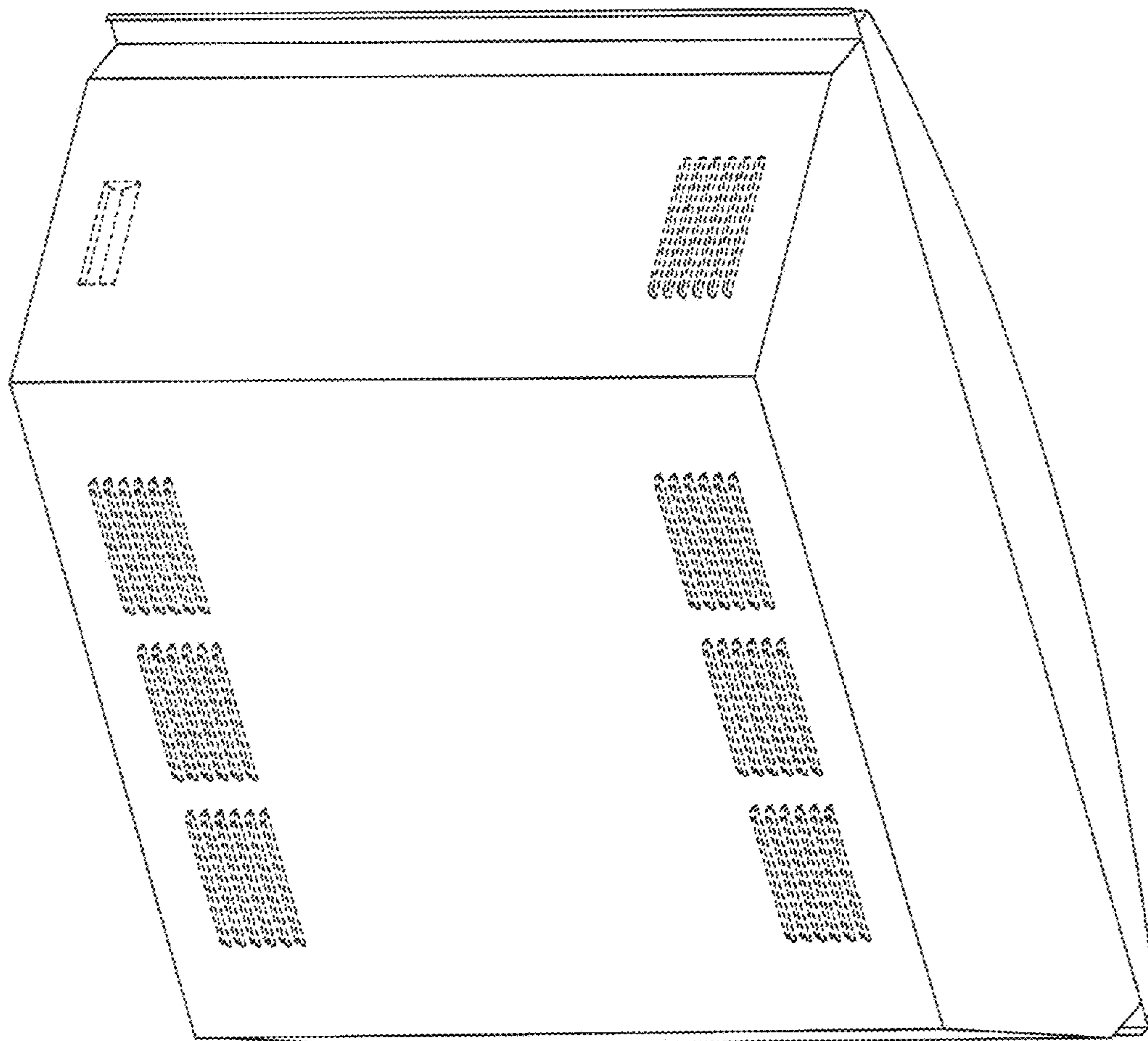

FIG. 50

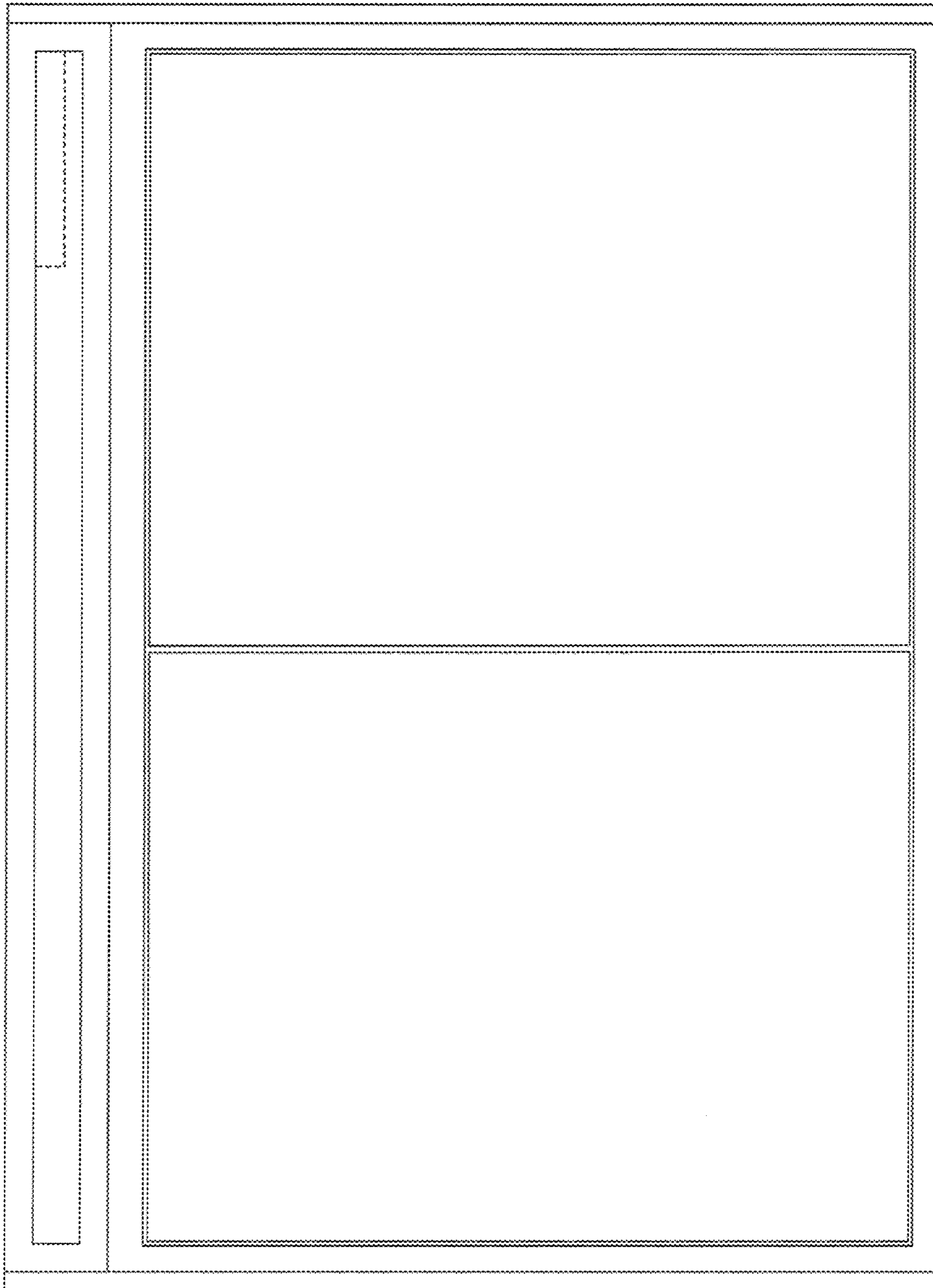

FIG. 51

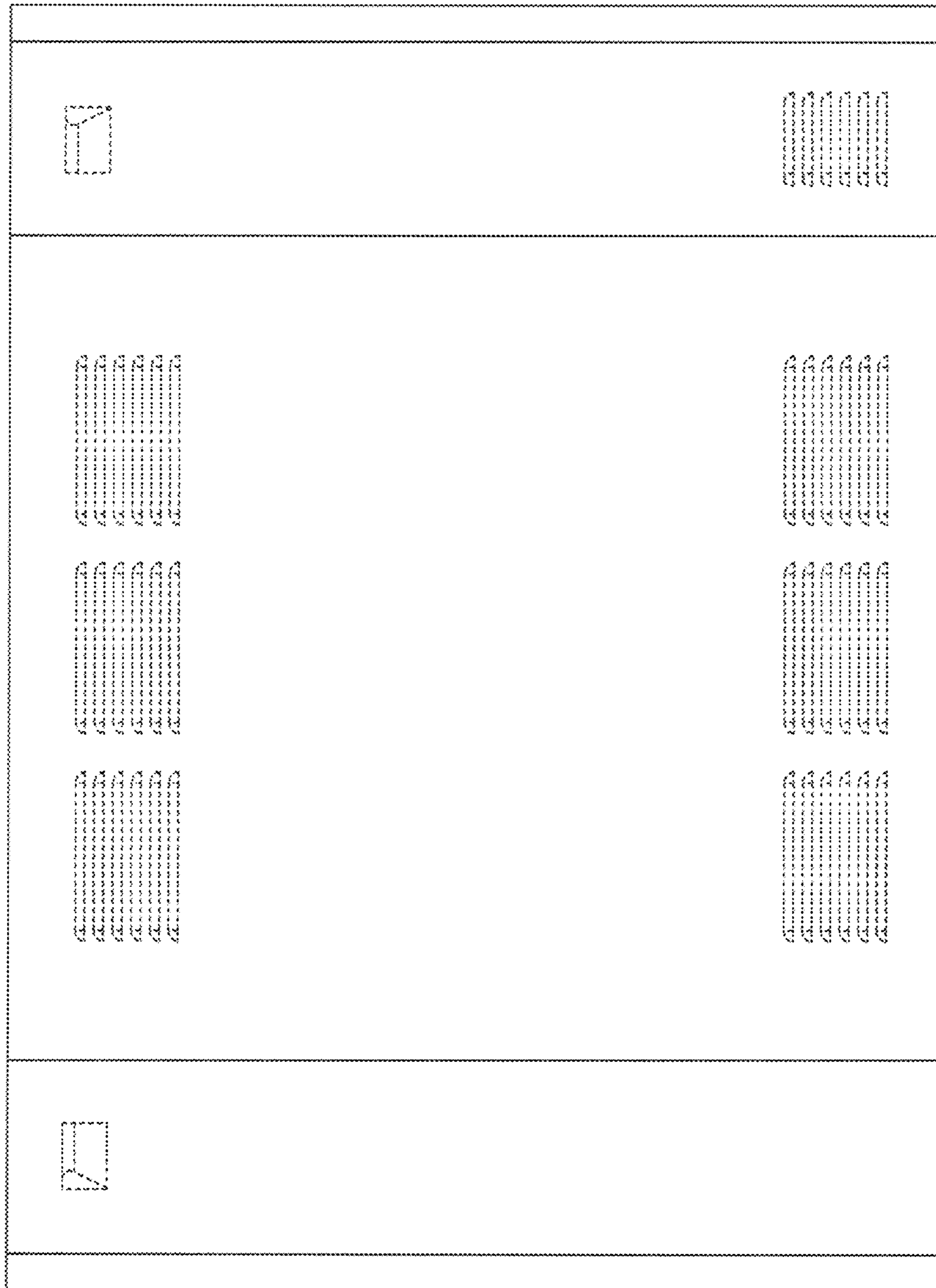

FIG. 52

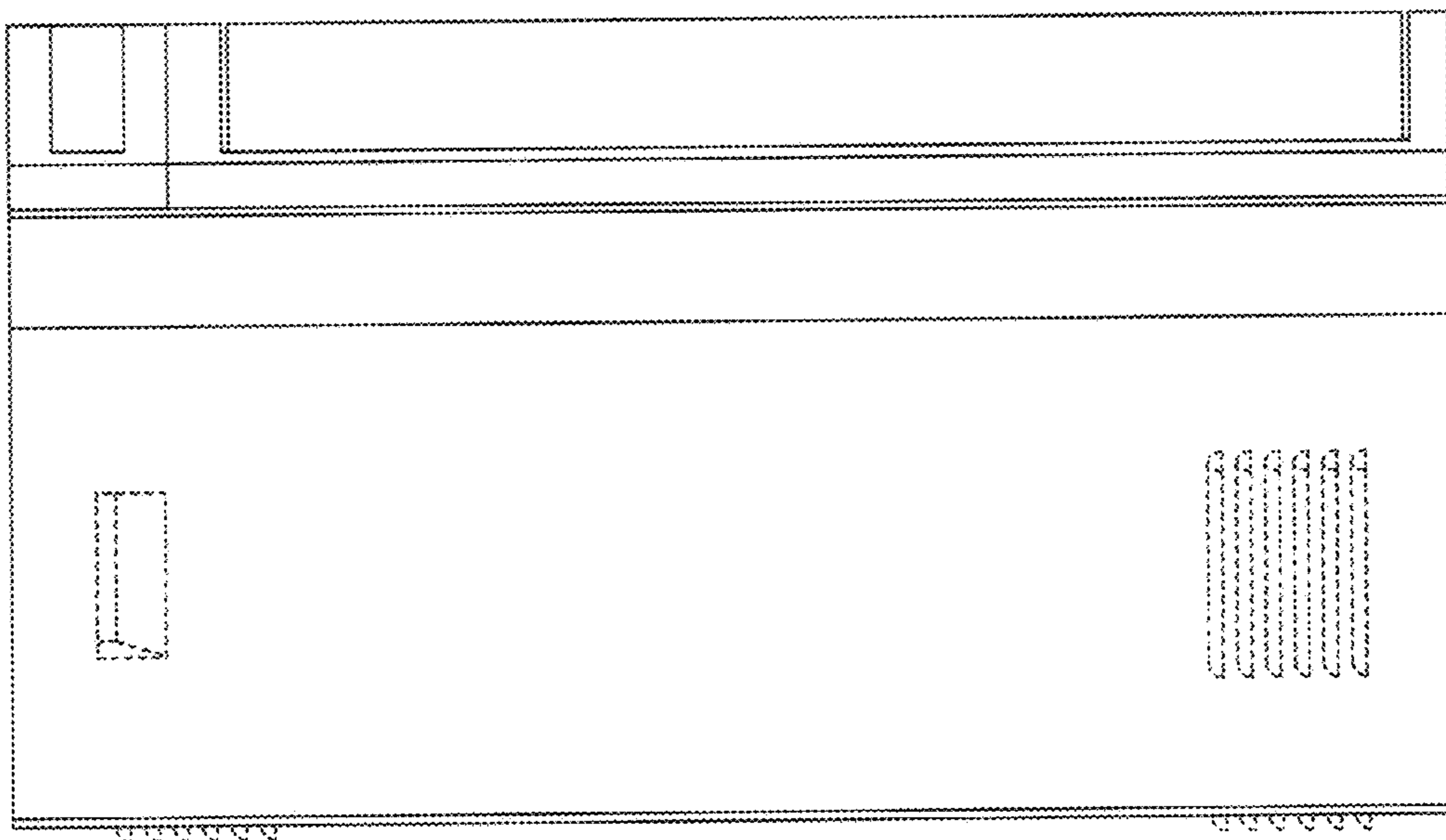

FIG. 53

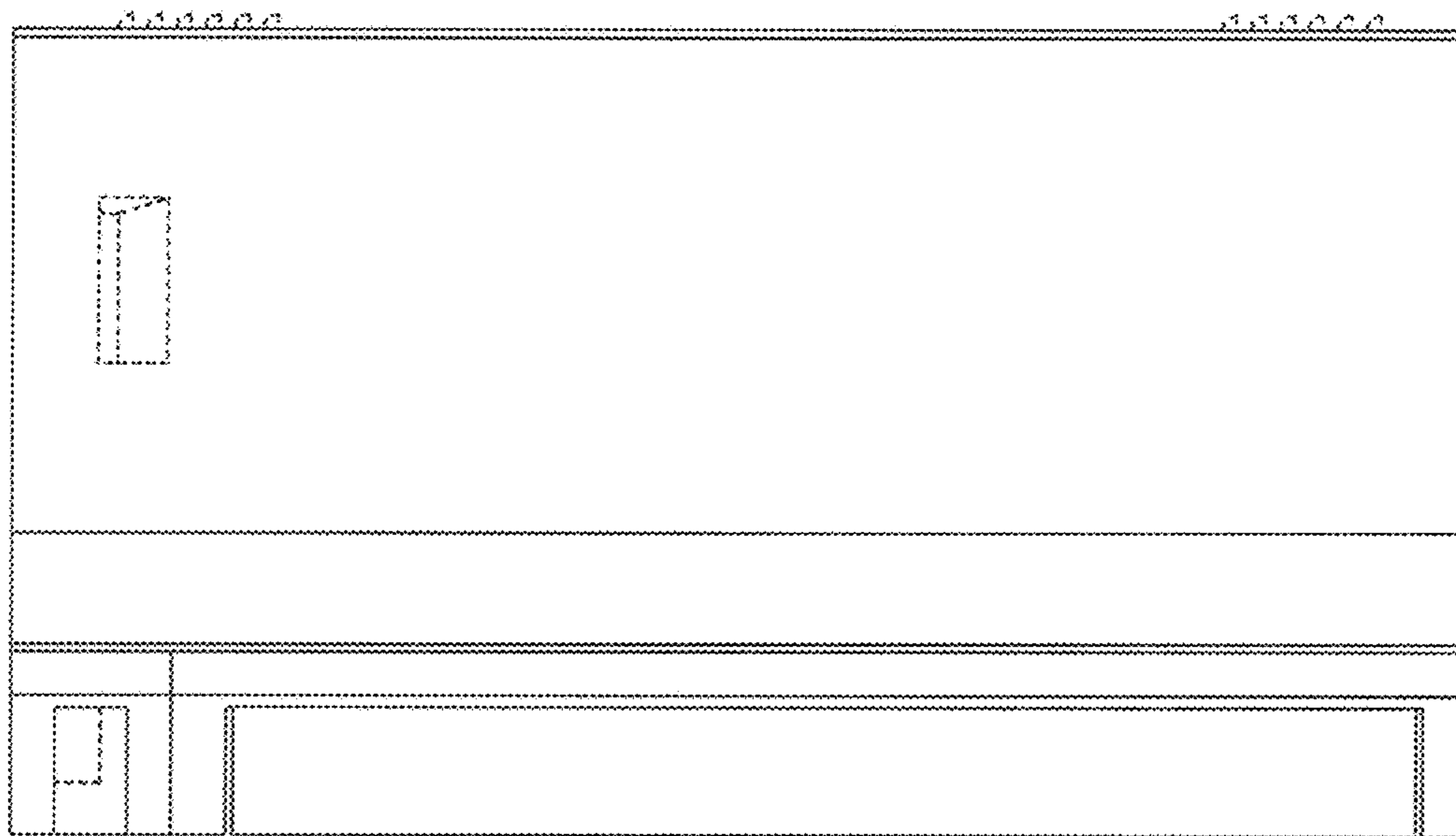

FIG. 54

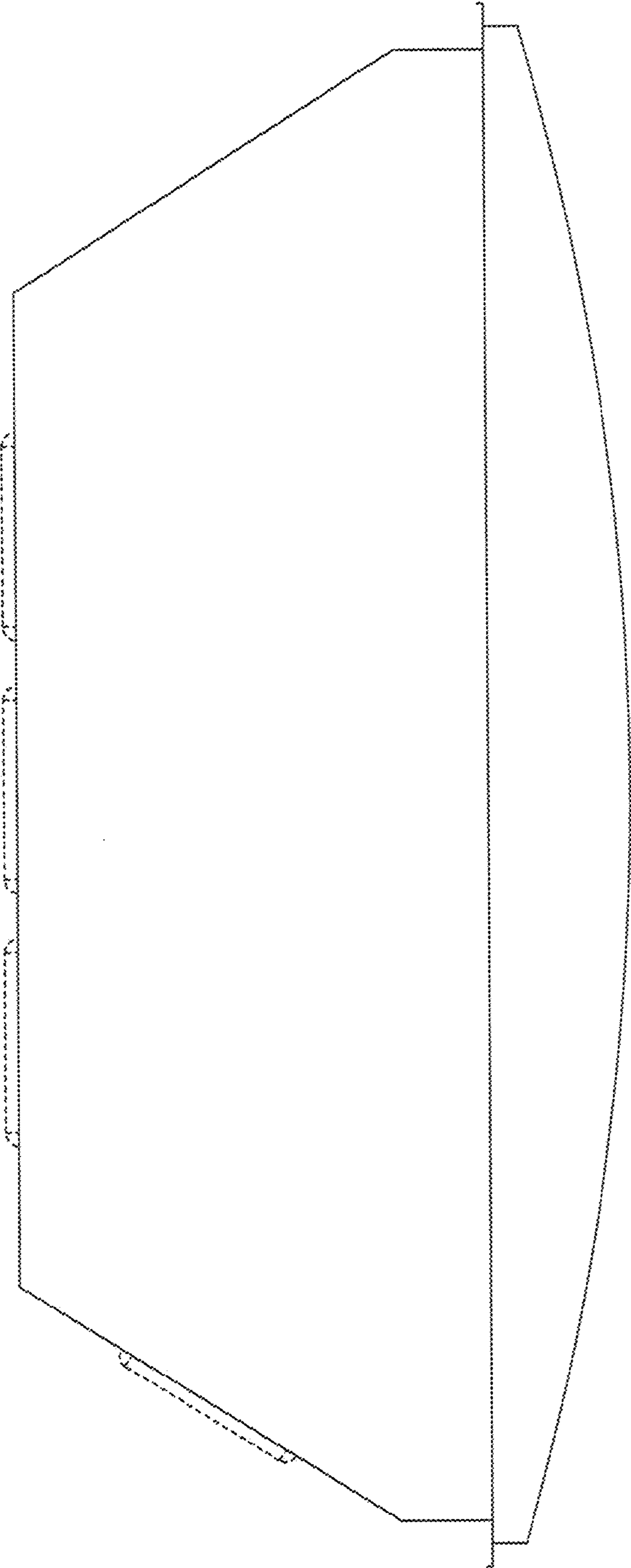

FIG. 55

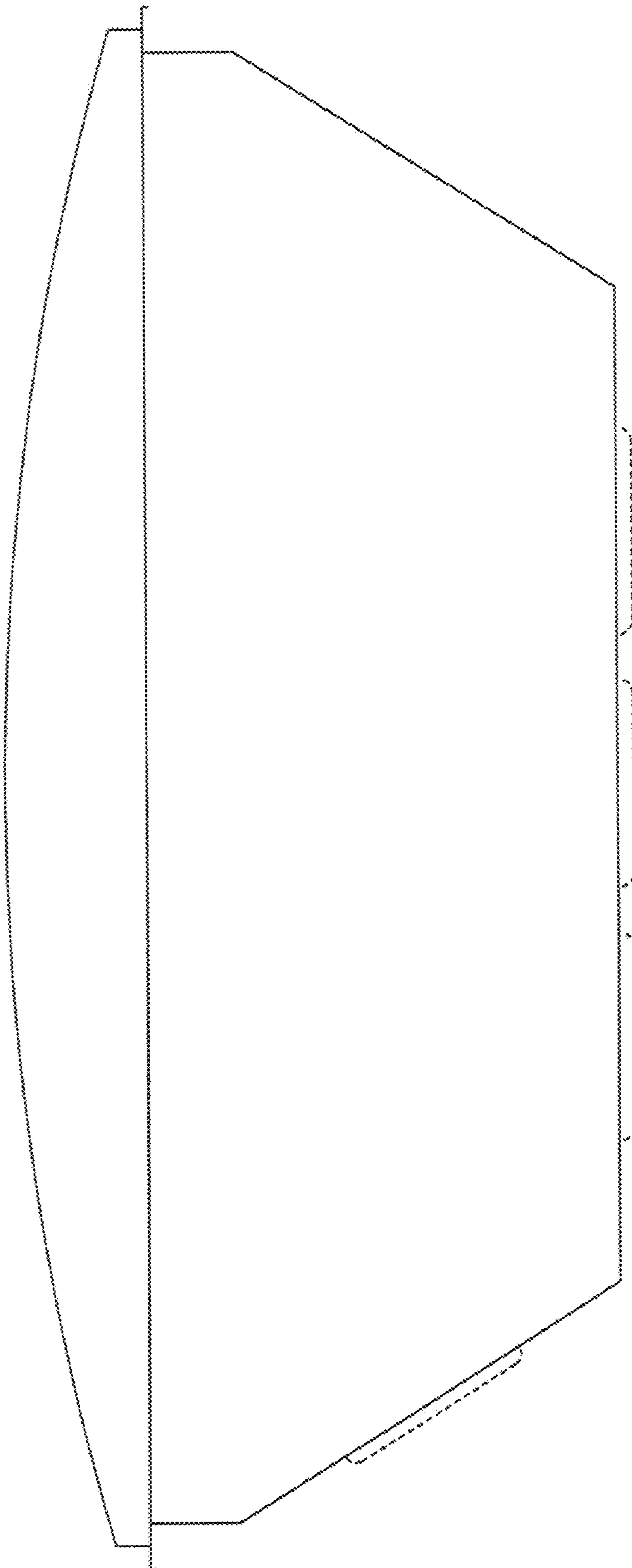

FIG. 56

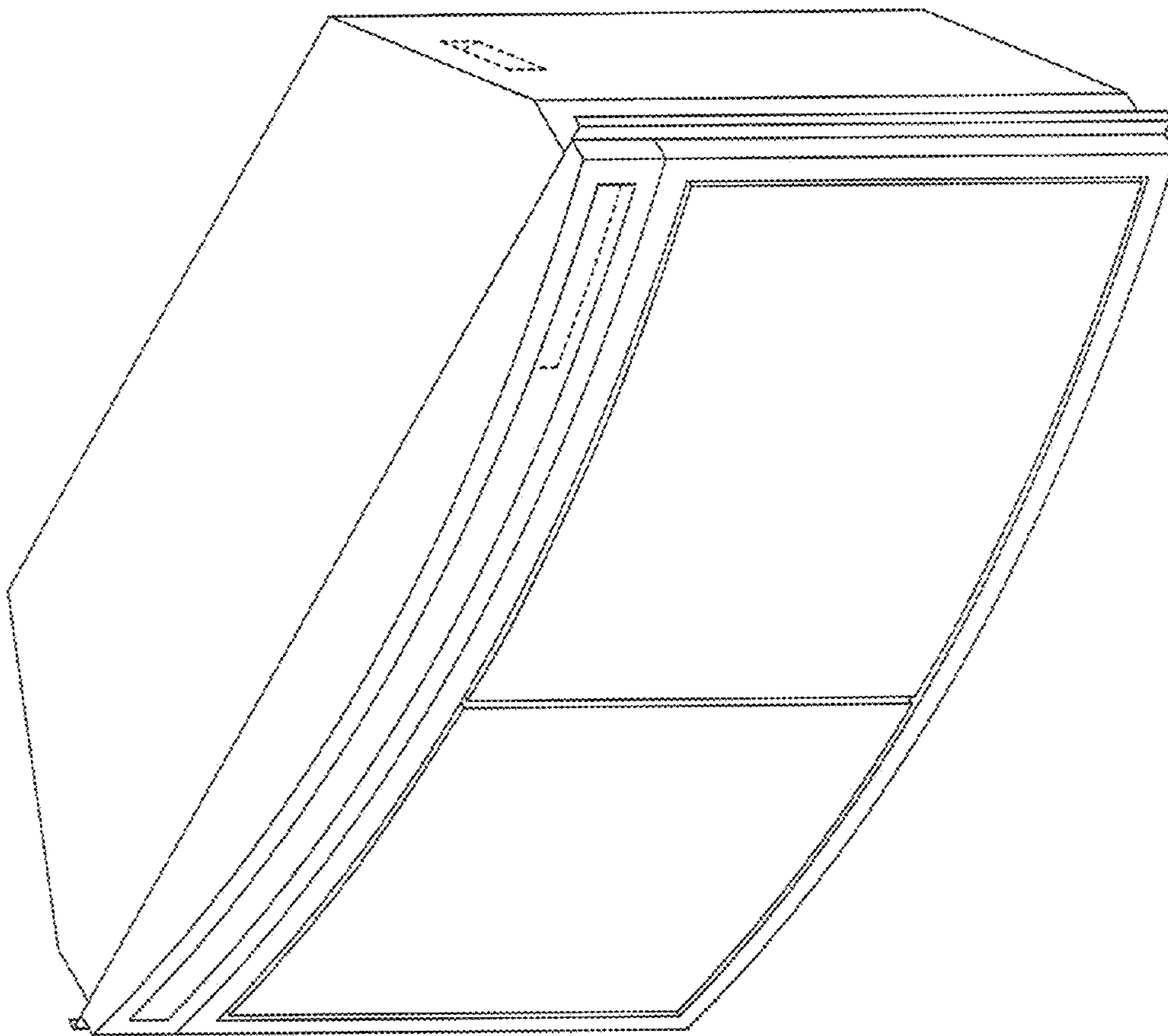

FIG. 57

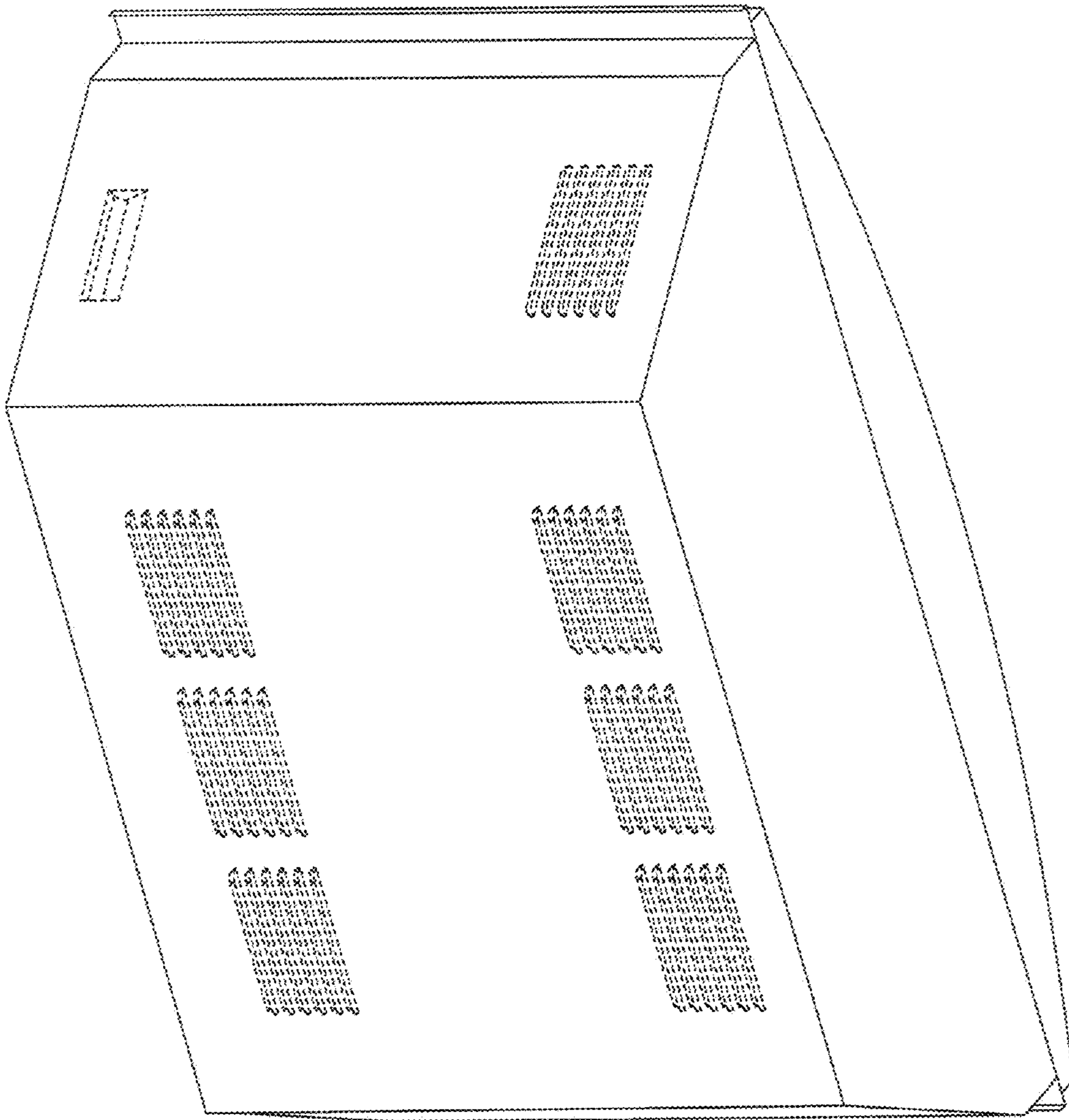

FIG. 58

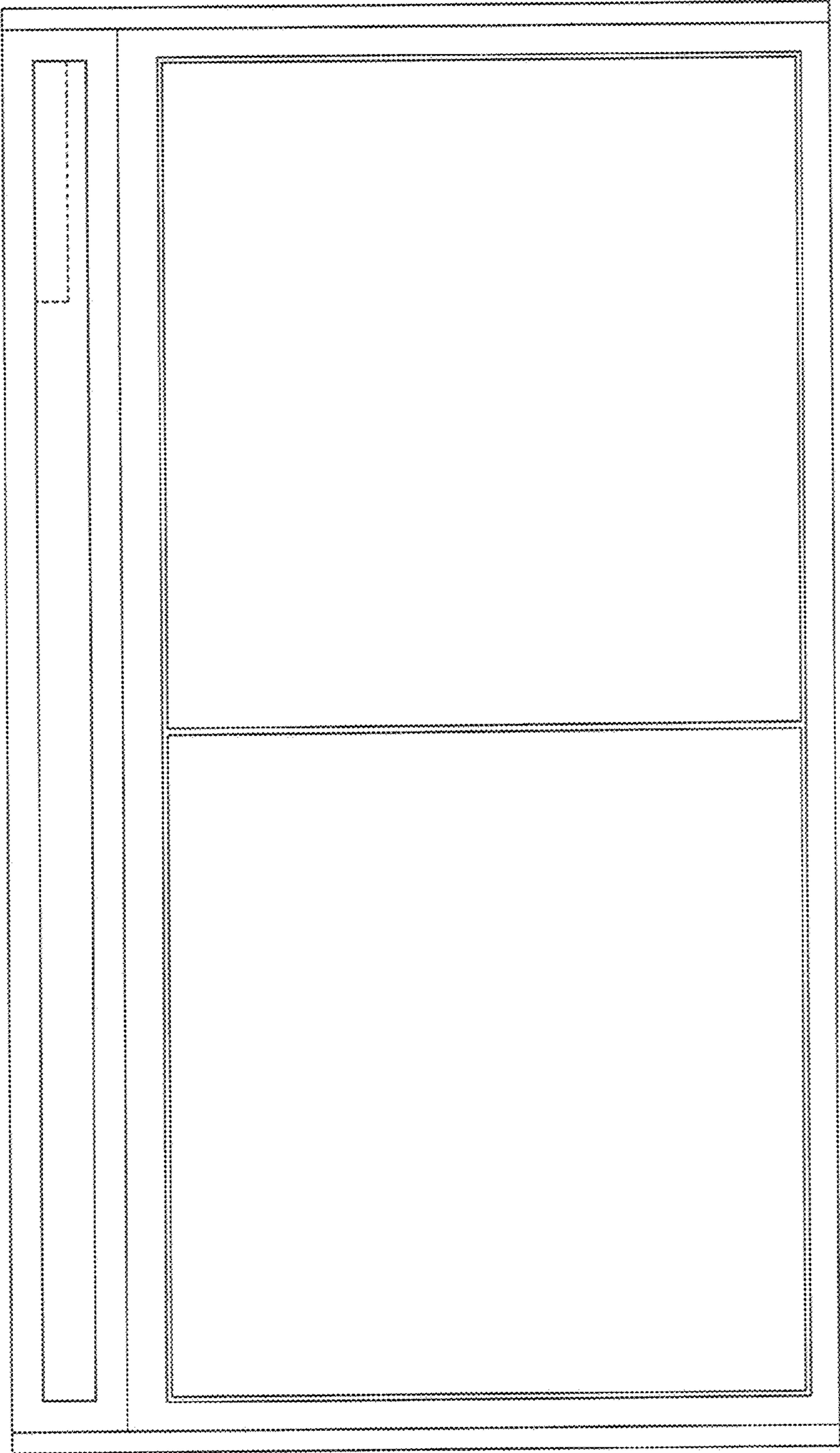

FIG. 59

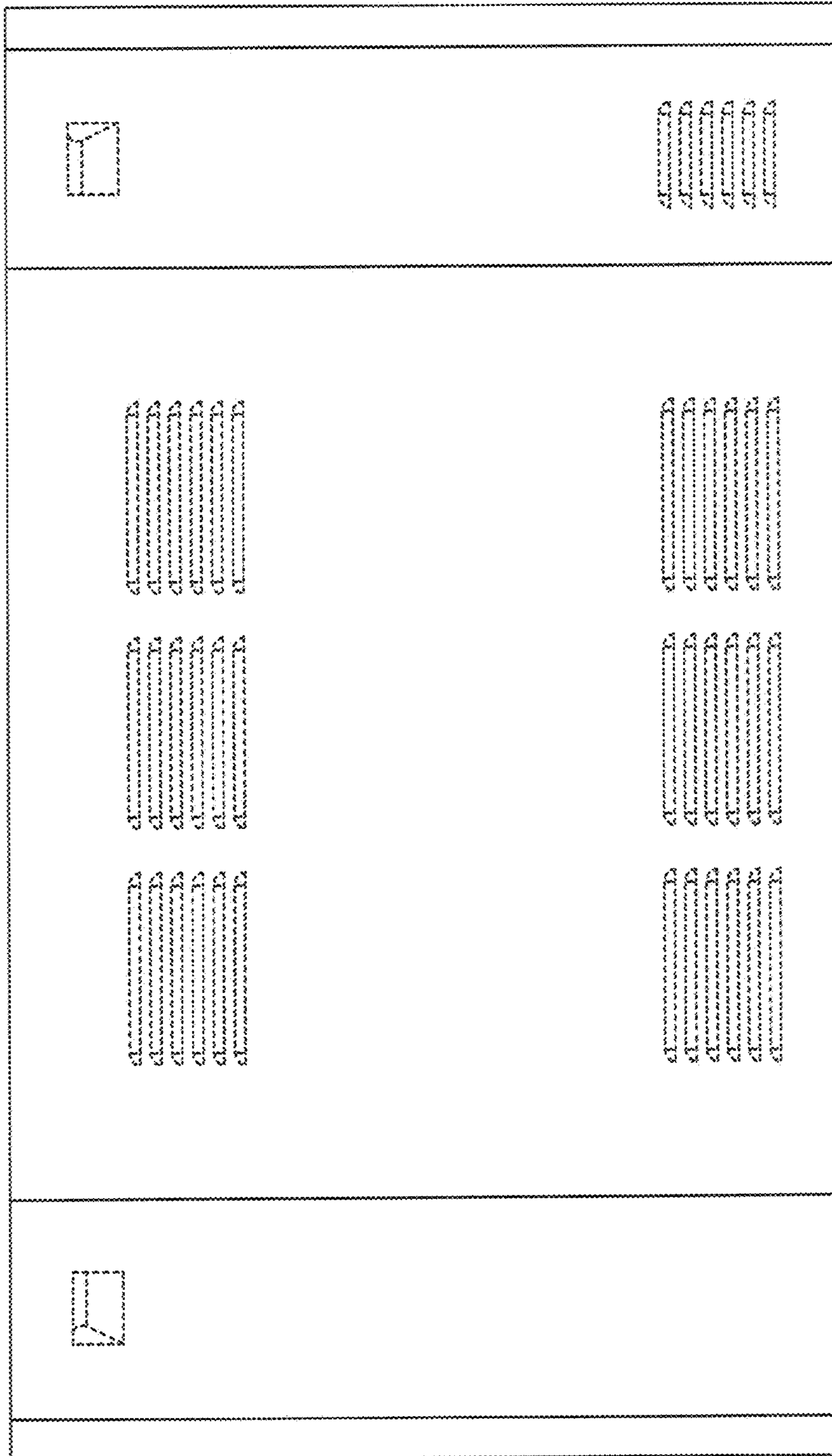

FIG. 60

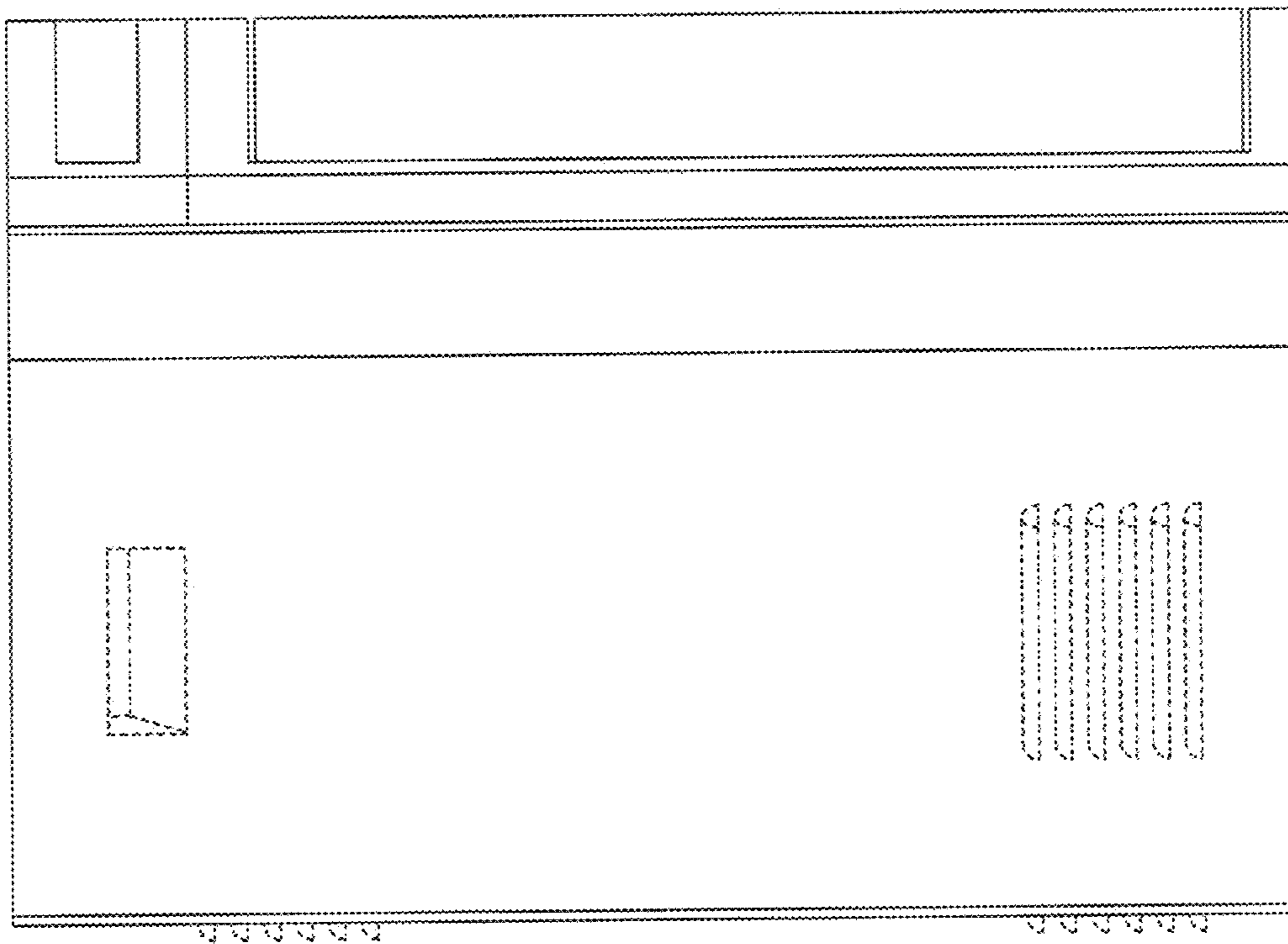

FIG. 61

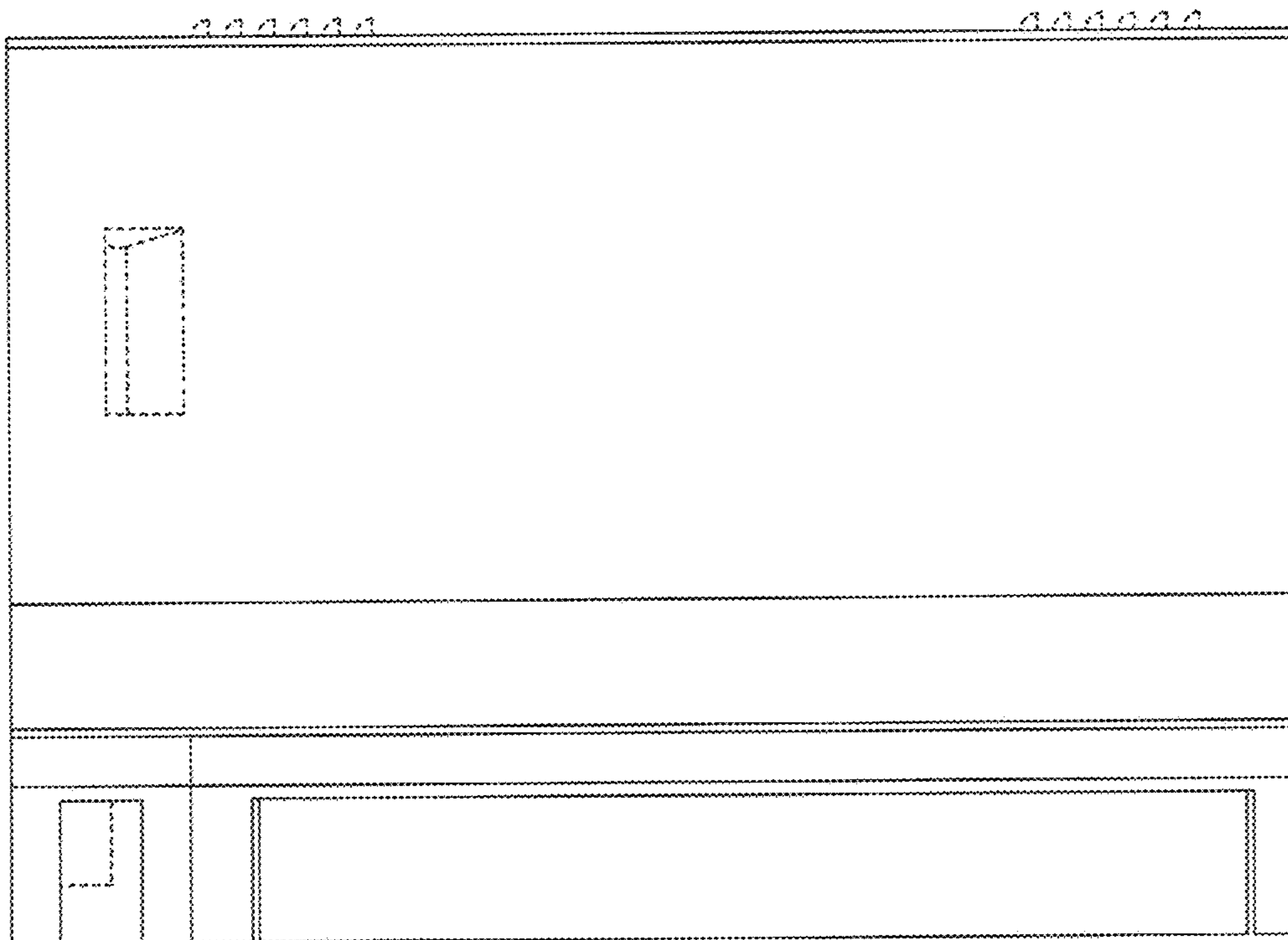

FIG. 62

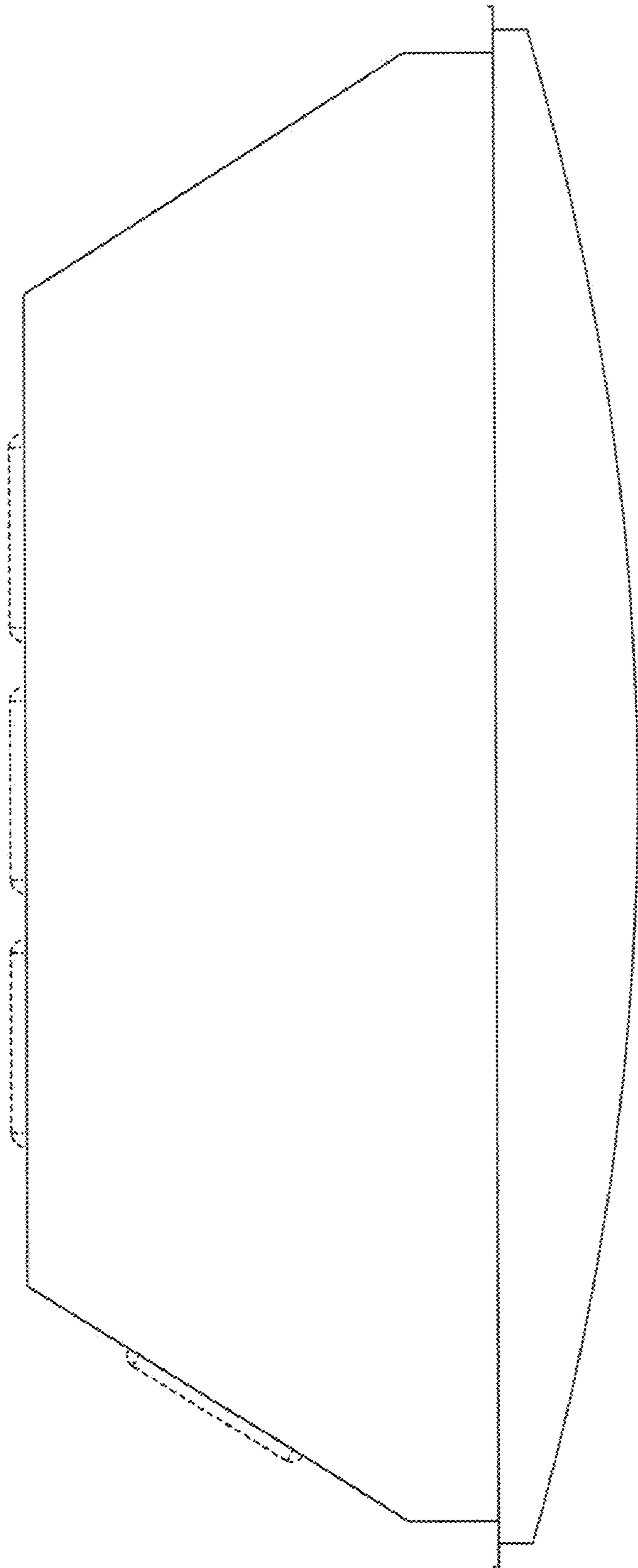

FIG. 63

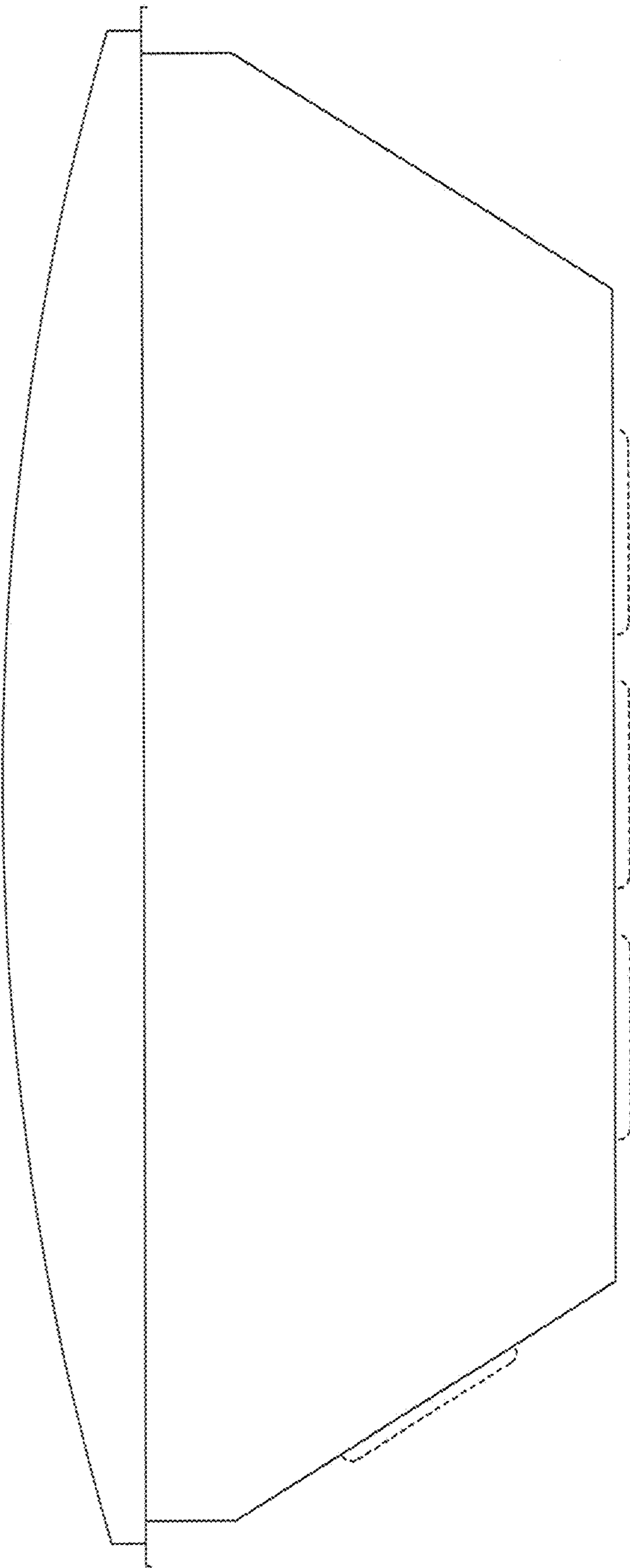

FIG. 64

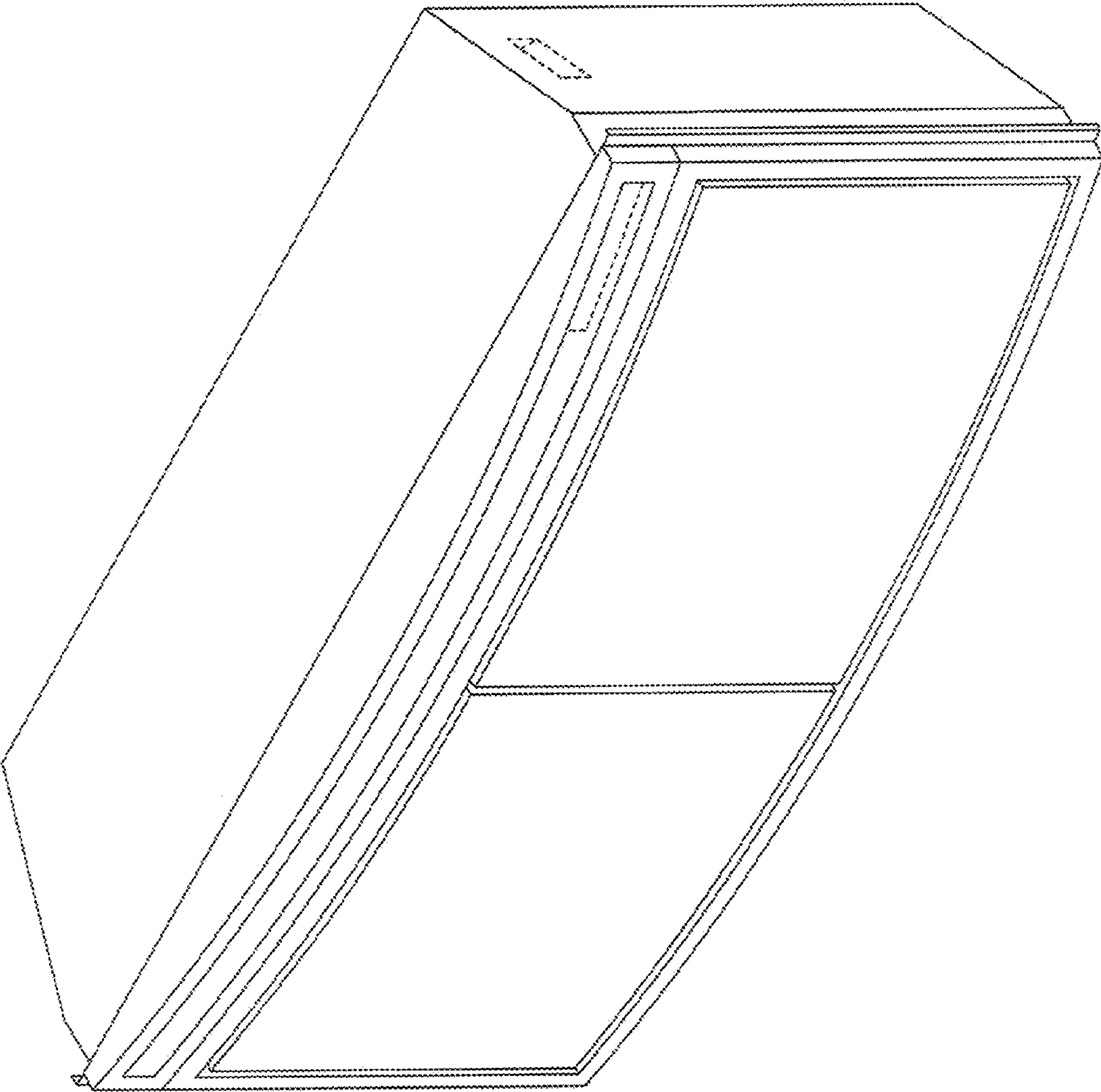

FIG. 65

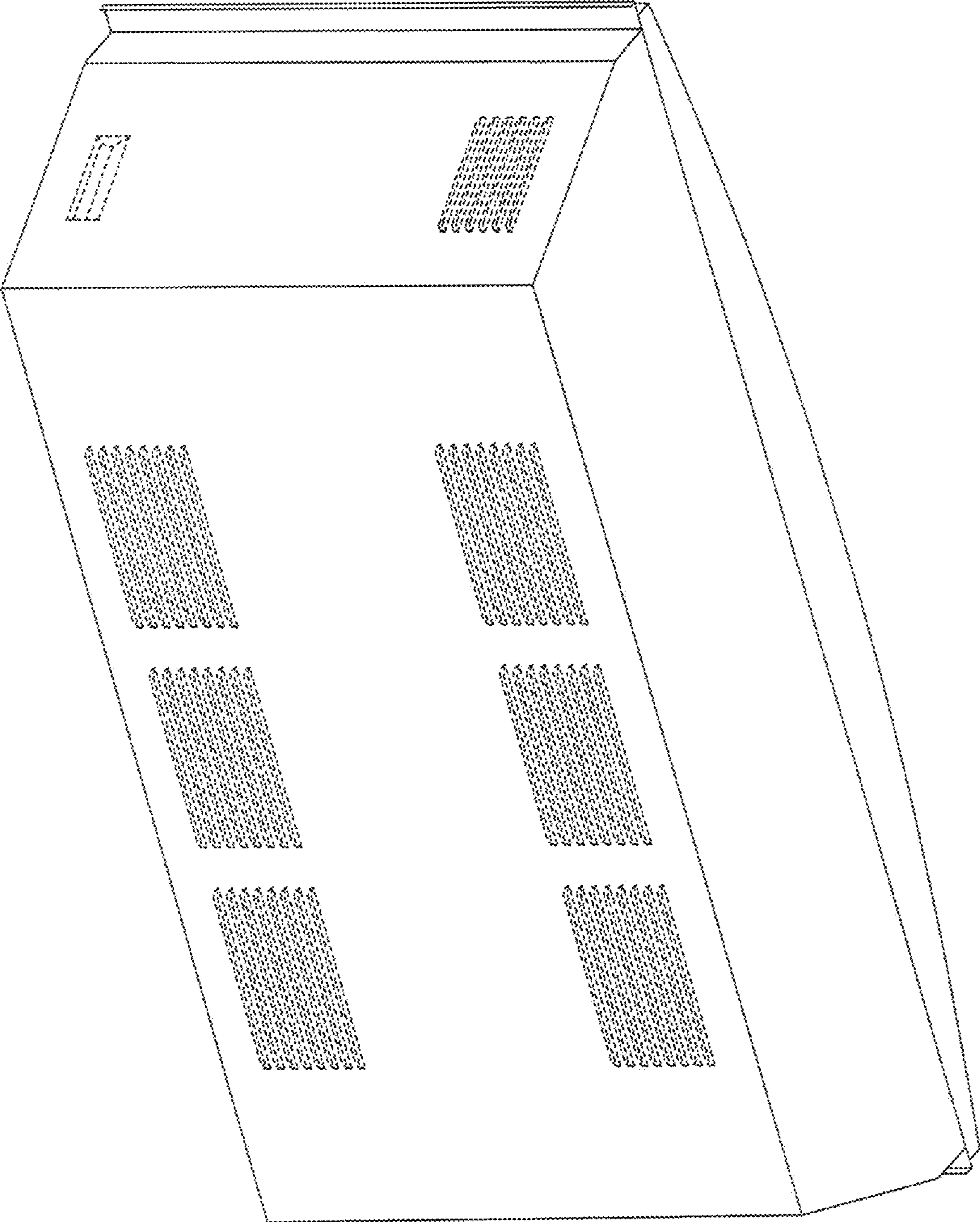

FIG. 66

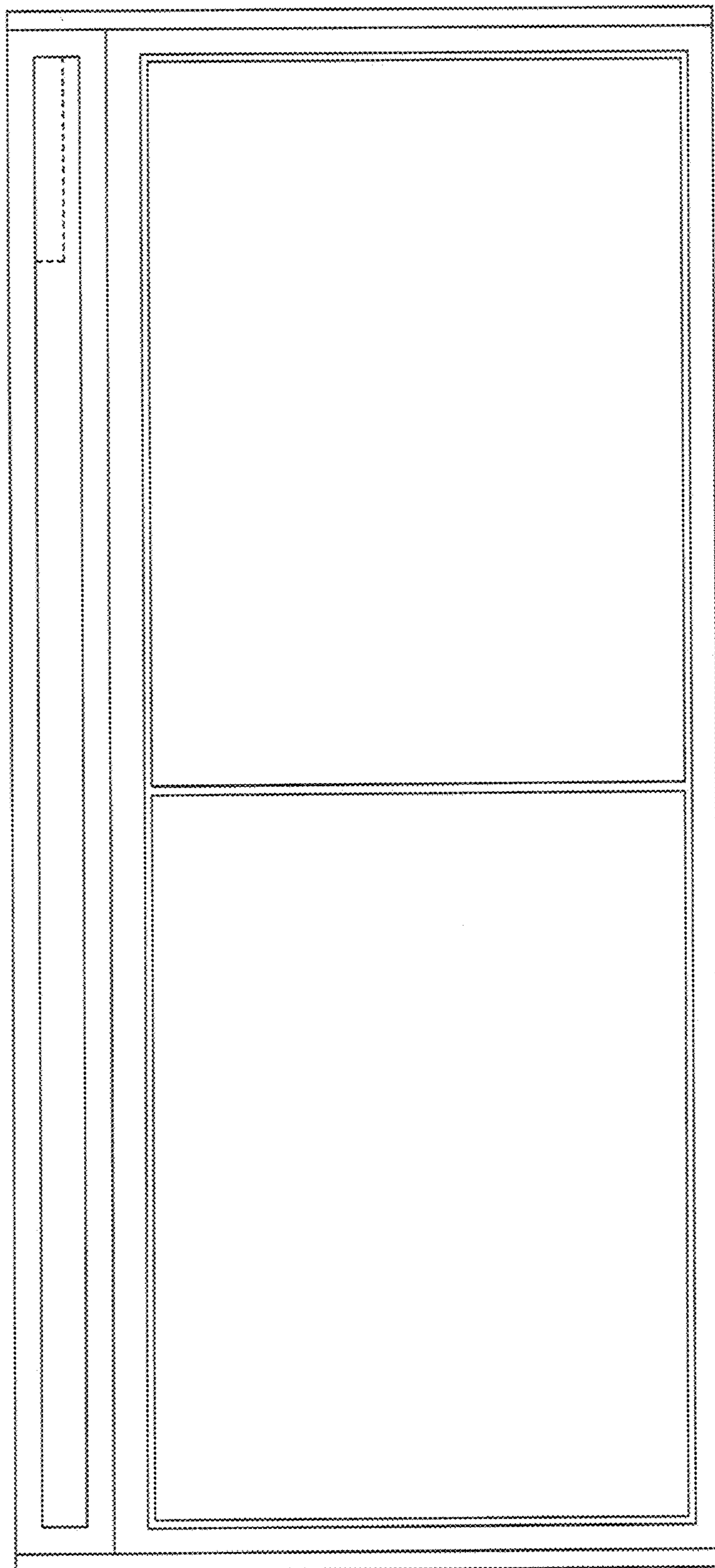

FIG. 67

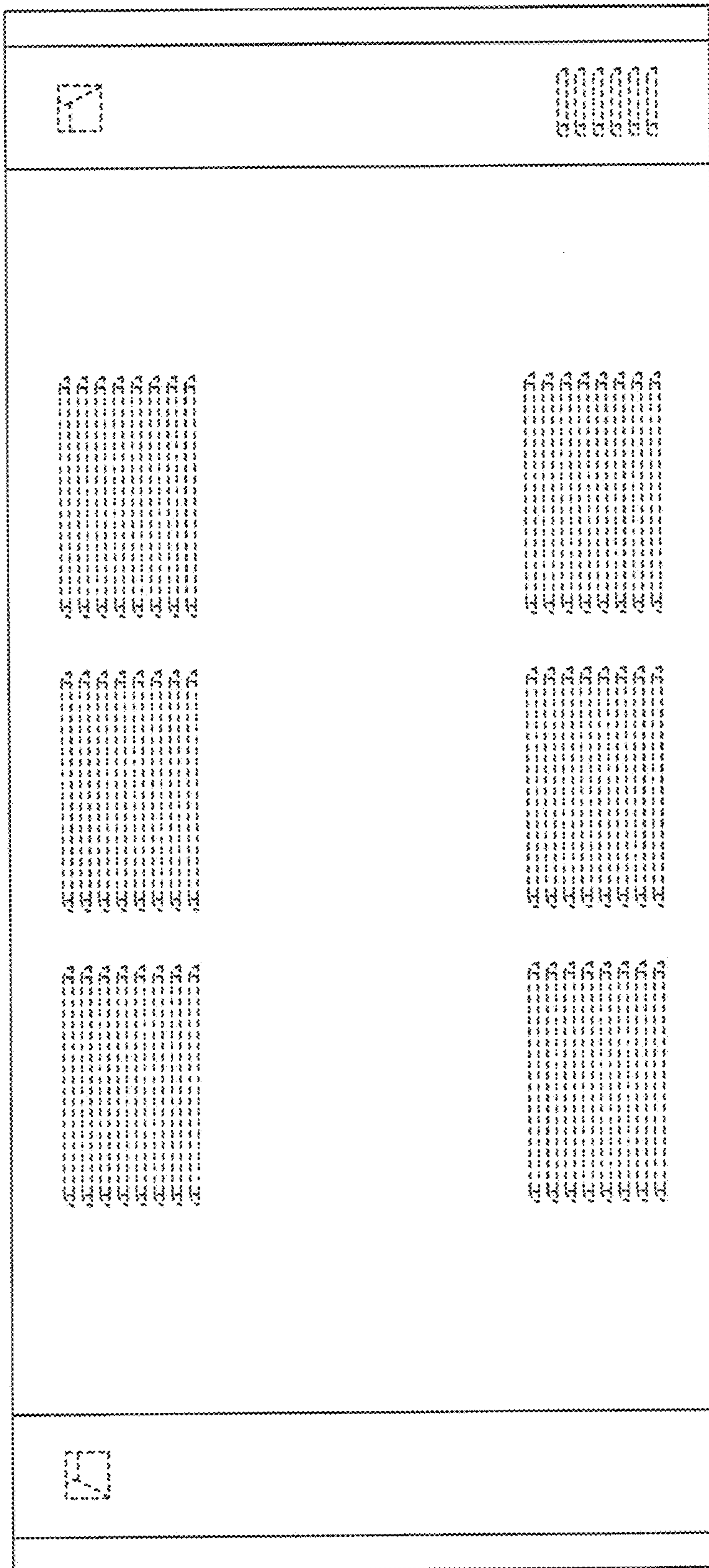

FIG. 68

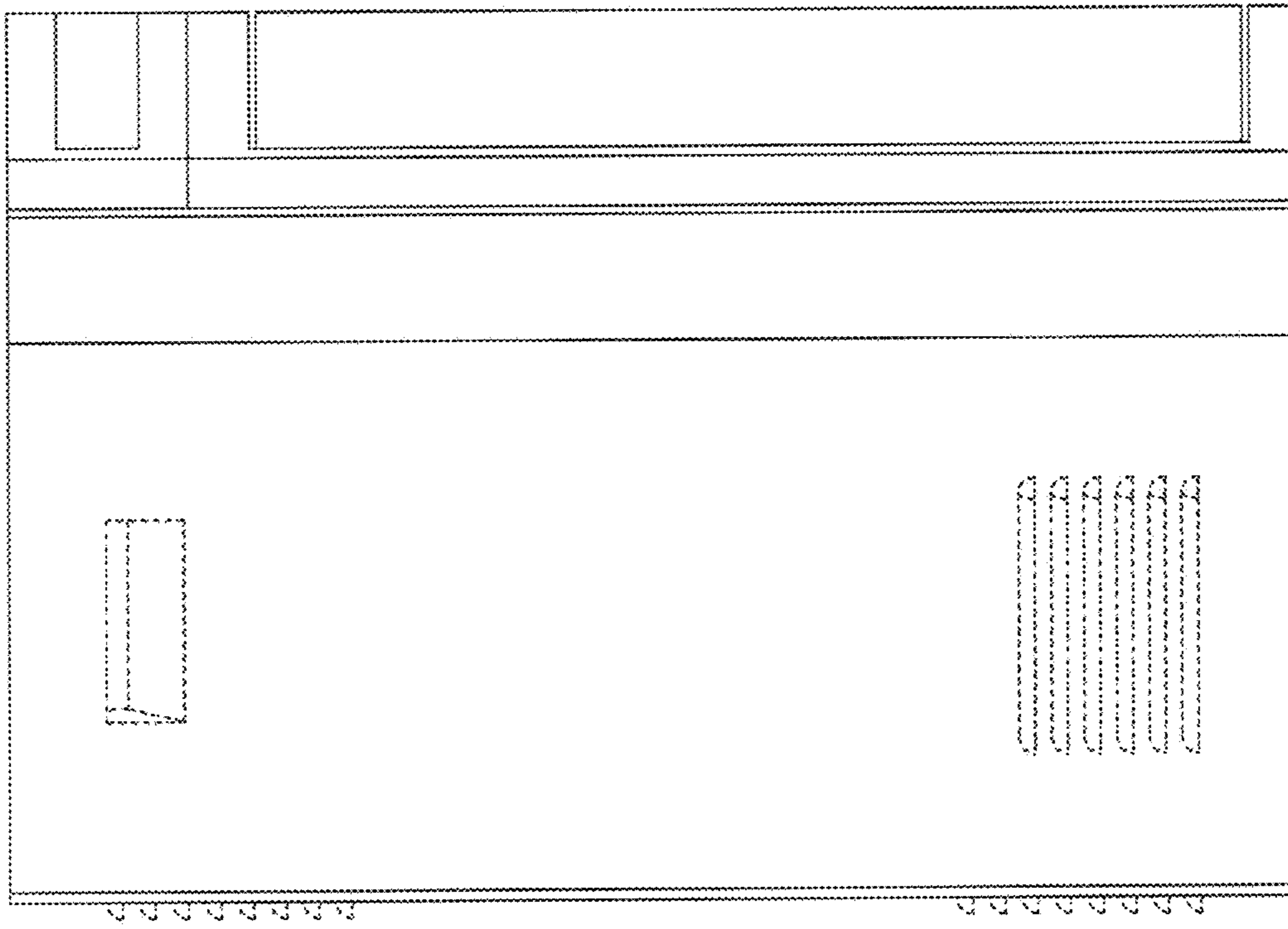

FIG. 69

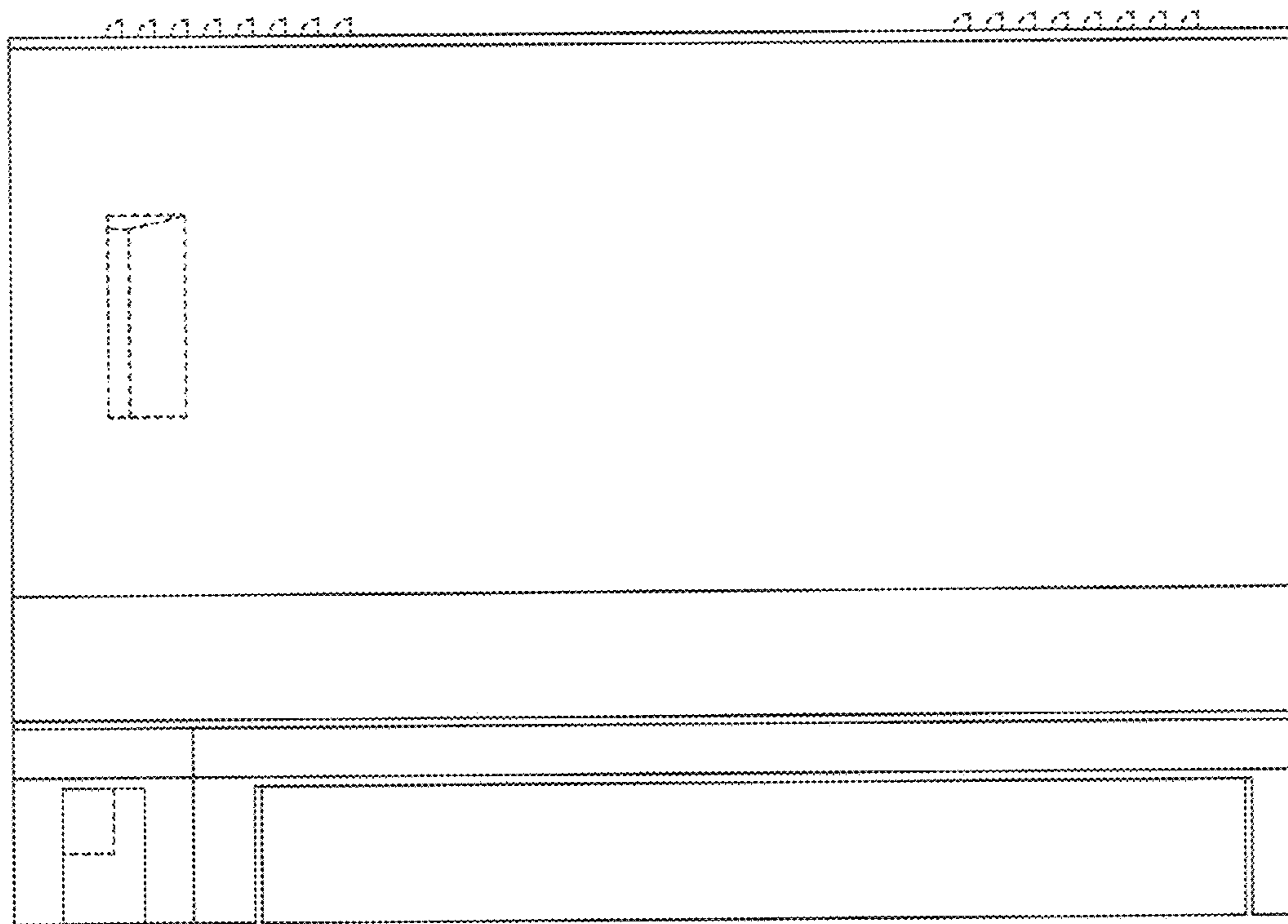

FIG. 70

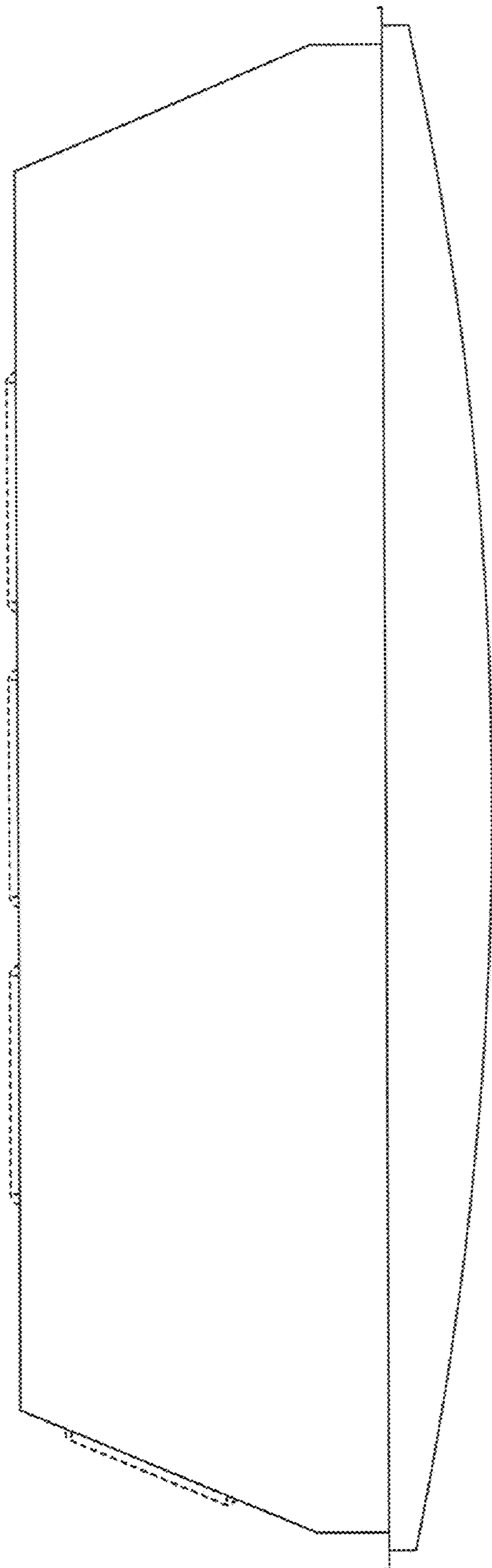

FIG. 71

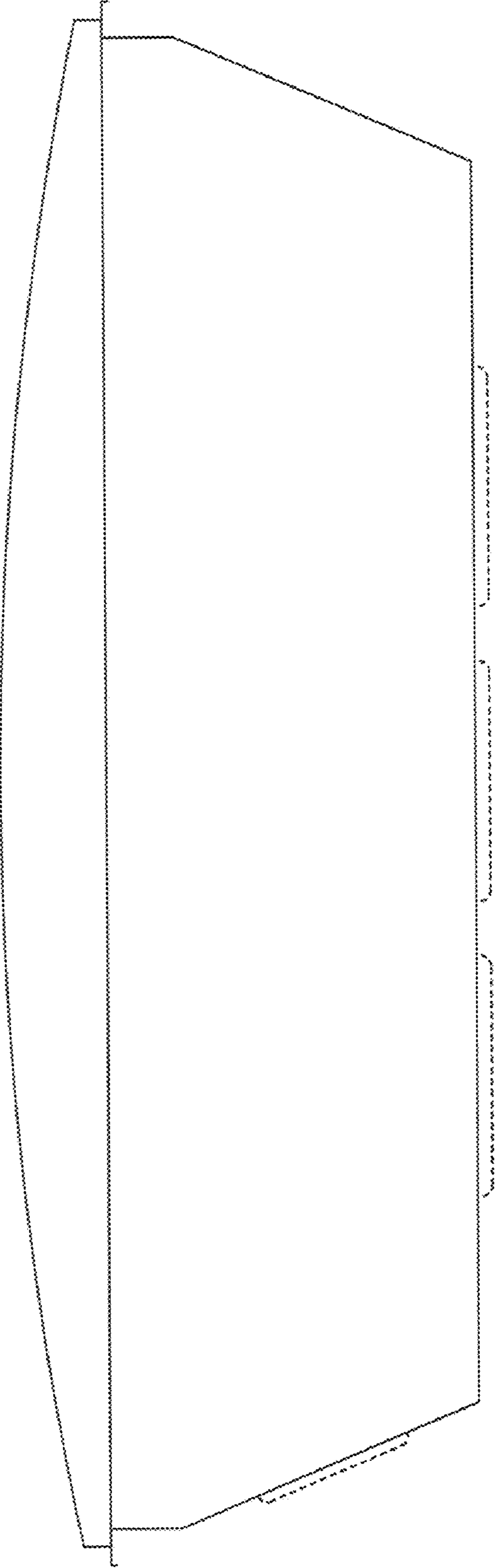

FIG. 72

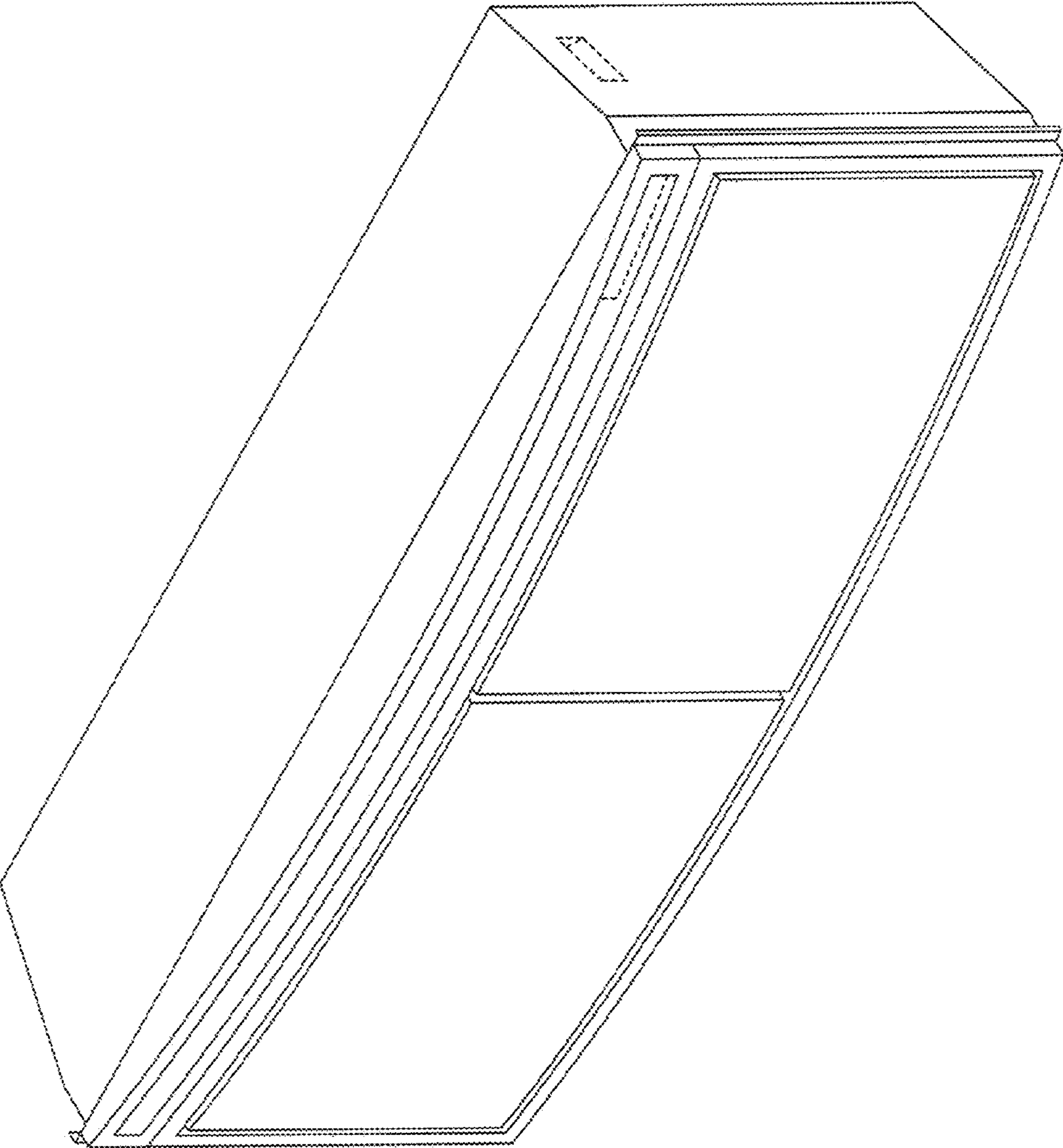

FIG. 73

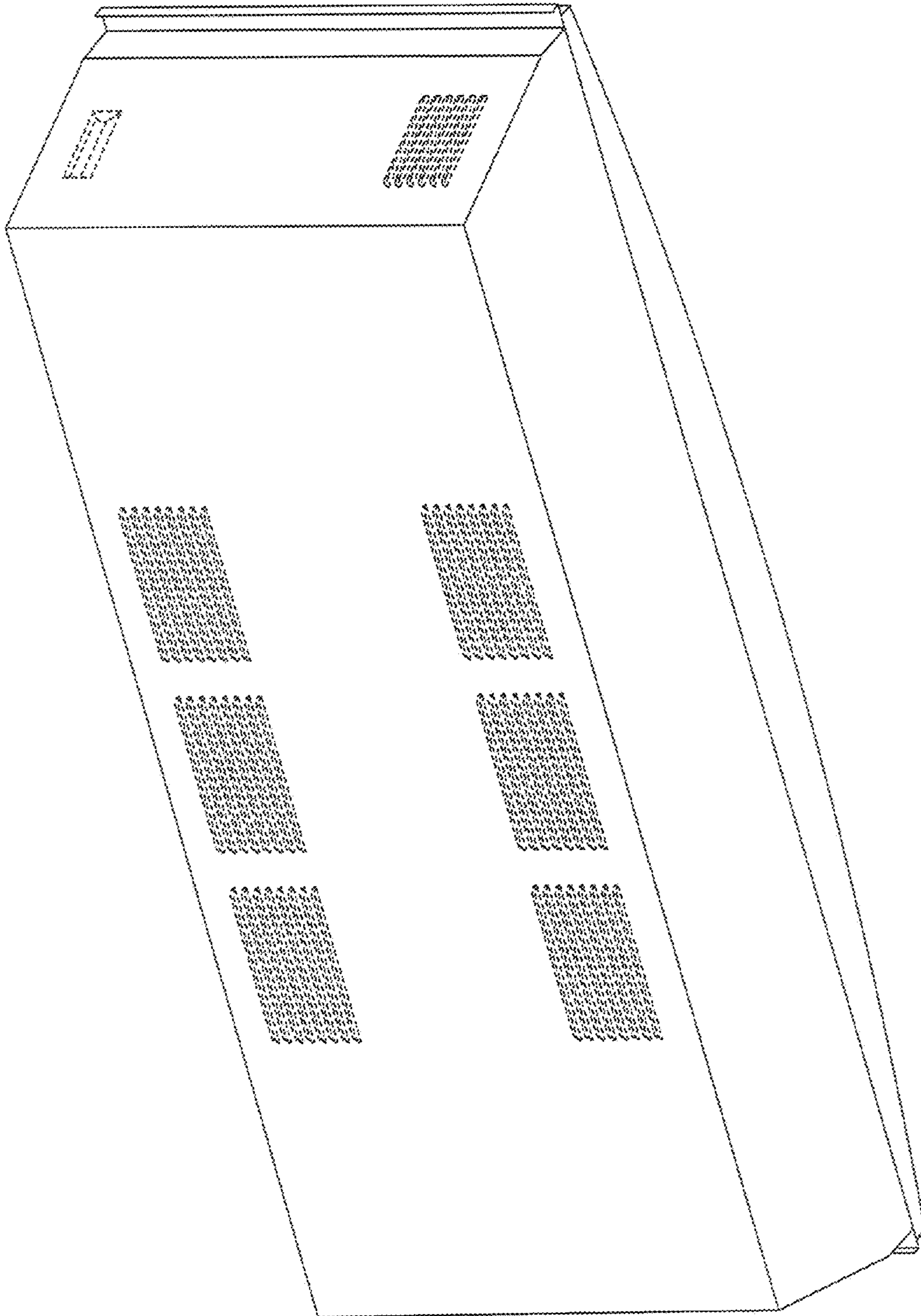

FIG. 74

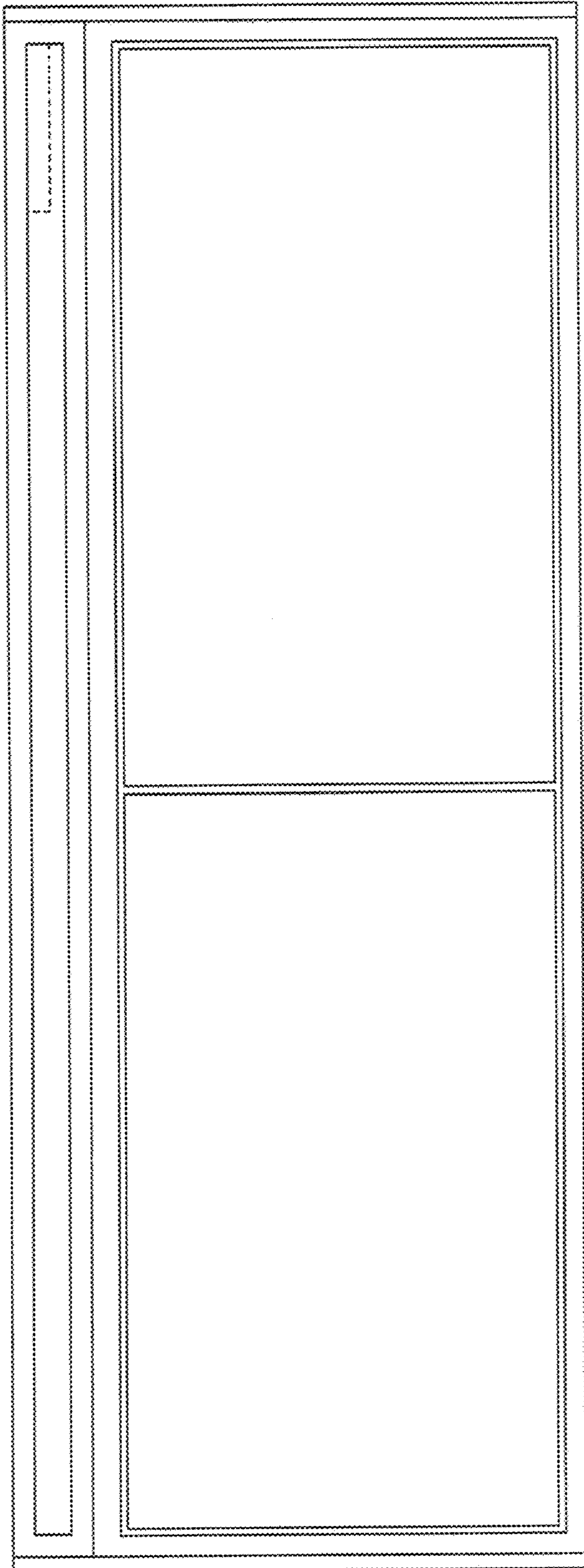

FIG. 75

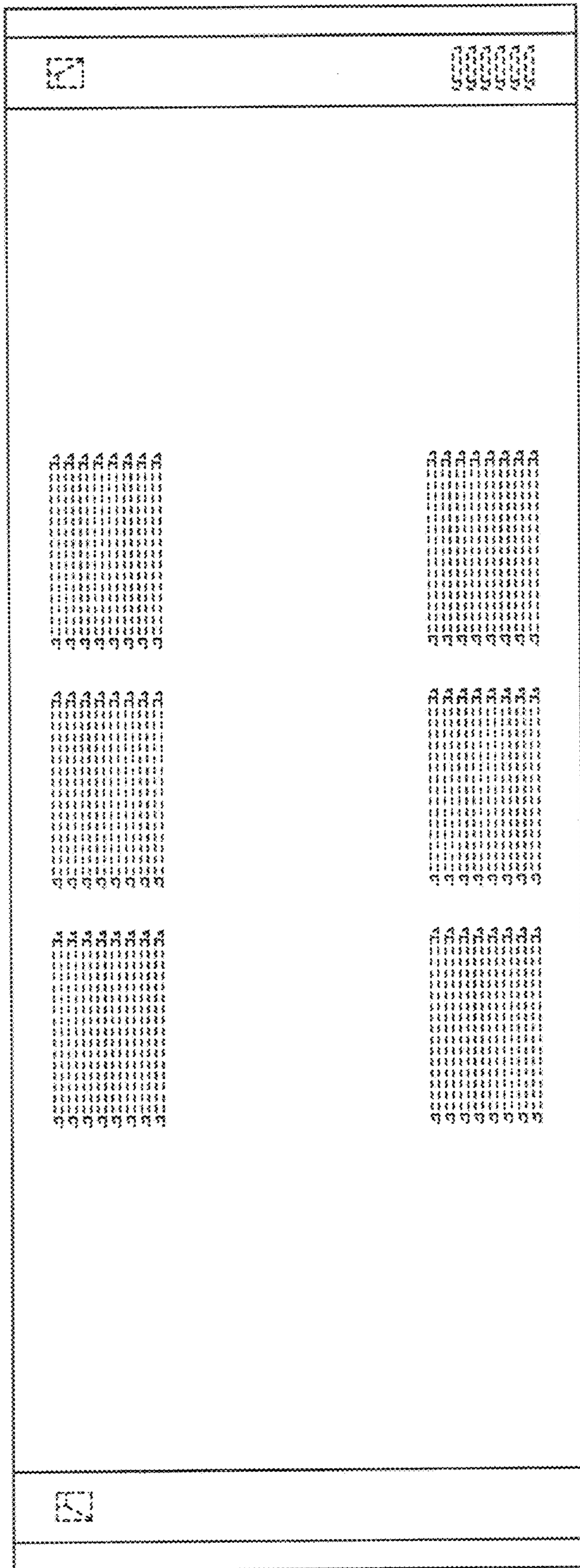

FIG. 76

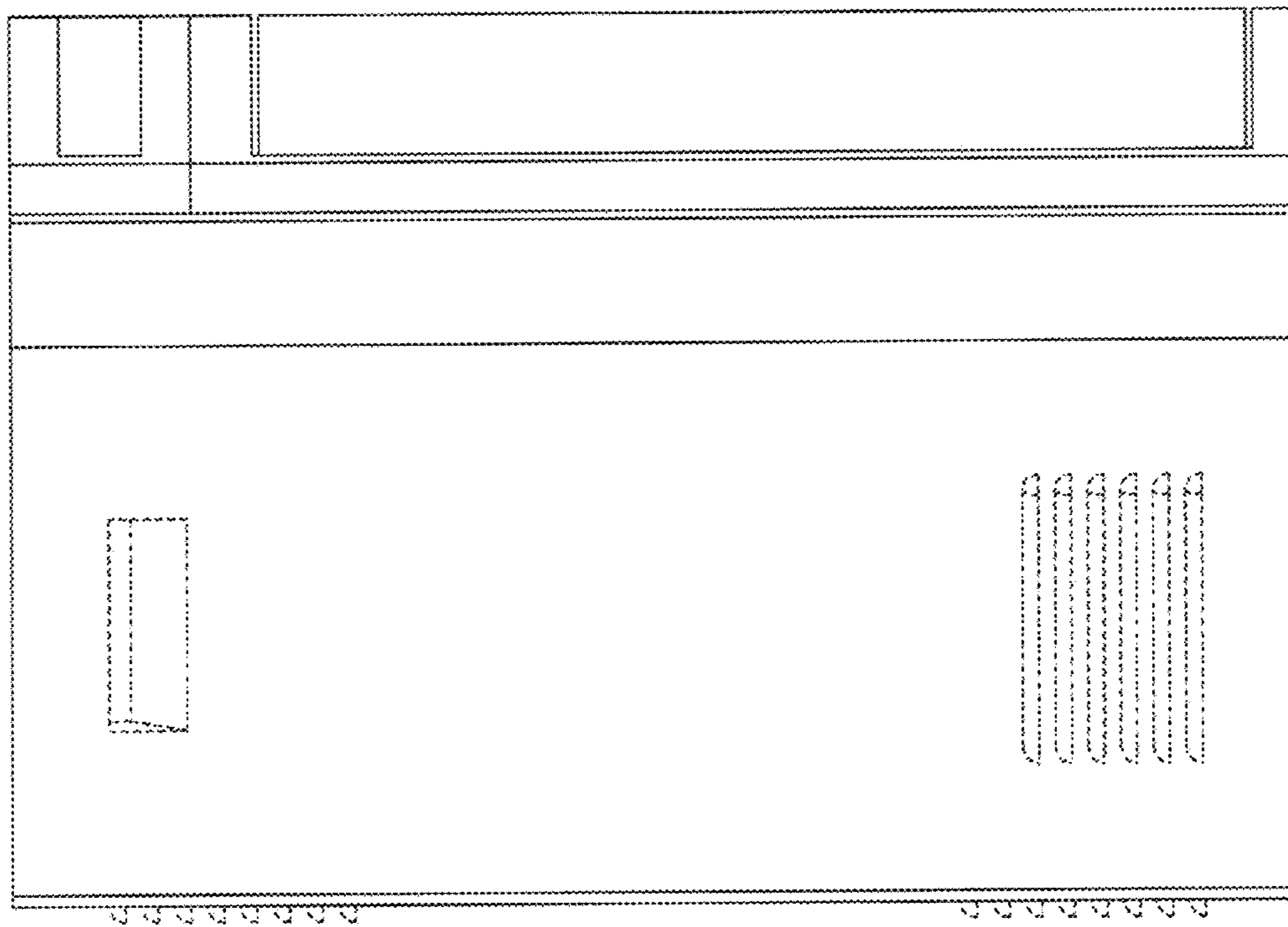

FIG. 77

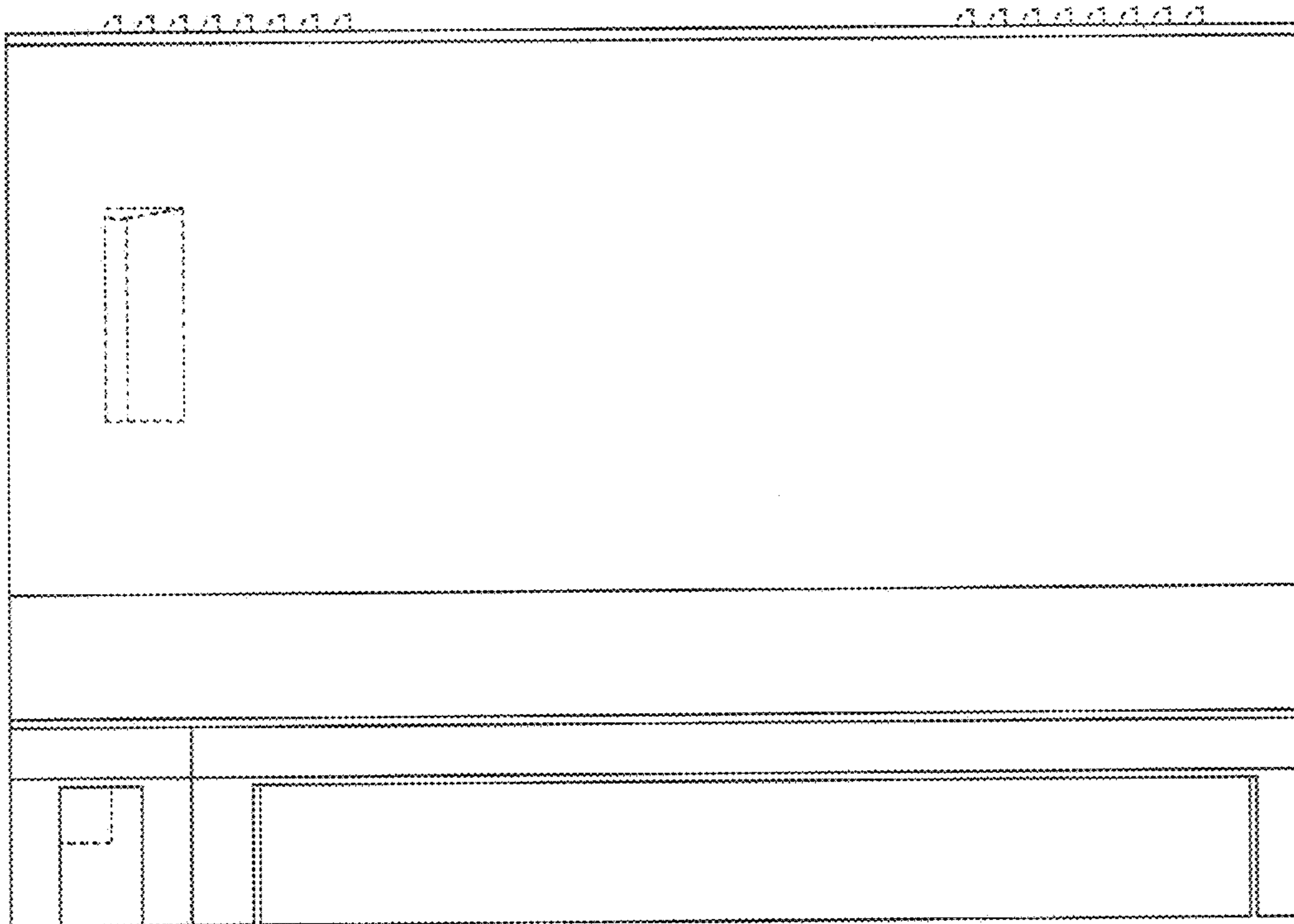

FIG. 78

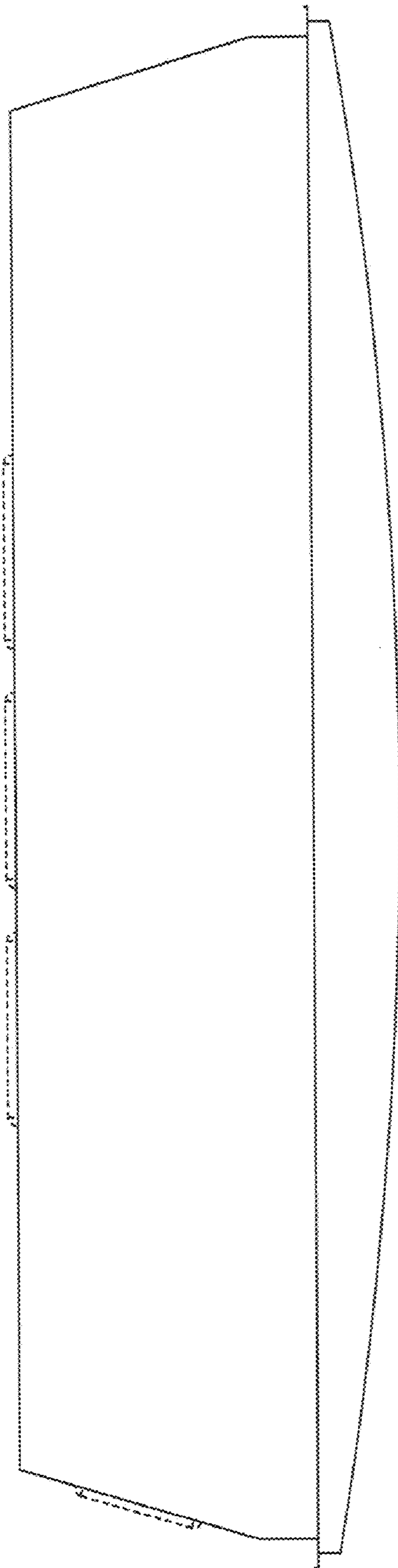

FIG. 79

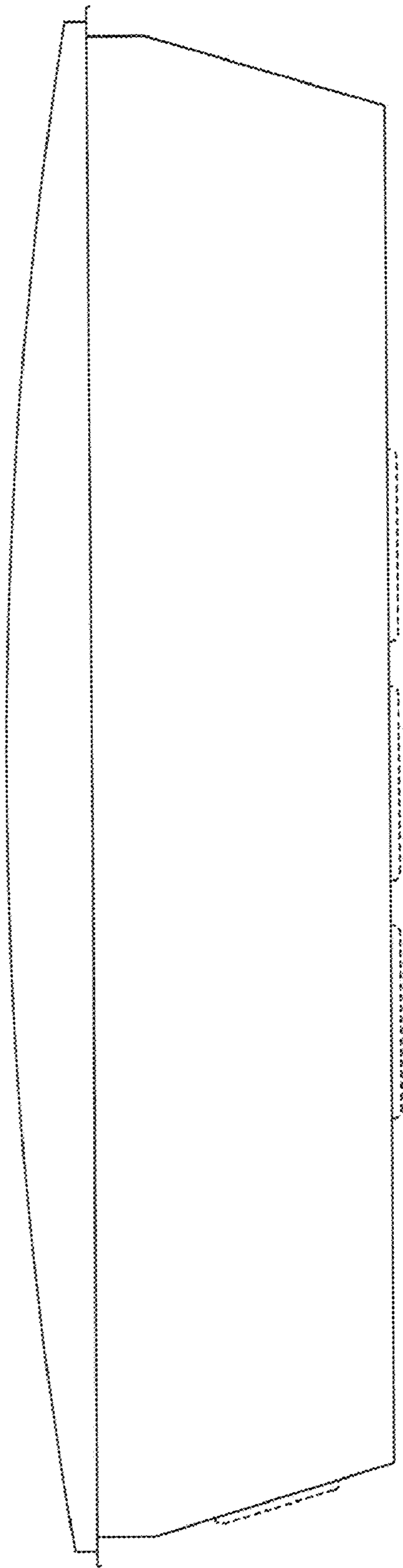

FIG. 80