



US00D668155S

(12) **United States Design Patent**  
**Wycoff**

(10) **Patent No.:** **US D668,155 S**

(45) **Date of Patent:** **\*\* Oct. 2, 2012**

(54) **CONTAINER**

(76) Inventor: **Jeffrey Wycoff**, Boulder, CO (US)

(\*\*) Term: **14 Years**

(21) Appl. No.: **29/417,219**

(22) Filed: **Mar. 30, 2012**

**Related U.S. Application Data**

(60) Continuation of application No. 29/408,879, filed on Dec. 16, 2011, now Pat. No. Des. 659,541, which is a division of application No. 29/345,205, filed on Oct. 12, 2009, now Pat. No. Des. 653,548.

(51) **LOC (9) Cl.** ..... **09-01**

(52) **U.S. Cl.** ..... **D9/516**

(58) **Field of Classification Search** ..... D9/434,  
D9/443, 499, 516, 523-528, 530, 531, 533,  
D9/538-543, 559, 560, 572-575; D23/211.1,  
D23/211.2, 212; 215/200, 371, 381-385,  
215/396, 398; 220/660, 669, 679, 752  
See application file for complete search history.

(56) **References Cited**

**U.S. PATENT DOCUMENTS**

1,073,997 A	9/1913	London
D207,243 S	3/1967	Kelly
D219,867 S	2/1971	Reimer
3,765,574 A	10/1973	Urquiza
4,016,995 A	4/1977	Frazer
D252,257 S	7/1979	Dobbs et al.
4,300,676 A	11/1981	Focke et al.
D295,611 S	5/1988	Warren et al.
4,805,793 A	2/1989	Brandt et al.
5,002,199 A	3/1991	Frahm
5,069,385 A	12/1991	Farber
5,114,028 A	5/1992	Ring
5,269,438 A	12/1993	Kelsey

(Continued)

**OTHER PUBLICATIONS**

U.S. Appl. No. 61/271,539, filed Jul. 22, 2009.

(Continued)

*Primary Examiner* — Prabhakar Deshmukh

*Assistant Examiner* — Keli L Hill

(74) *Attorney, Agent, or Firm* — Craig R. Miles; CR Miles, P.C.

(57) **CLAIM**

The ornamental design for a container, as shown and described.

**DESCRIPTION**

FIG. 1 is a top and left side perspective of a first embodiment of a container embodying my new design;

FIG. 2 is a side elevation view thereof showing the rear, left side;

FIG. 3 is a side elevation view thereof showing the front, right side;

FIG. 4 is a side elevation view thereof showing the rear, right side;

FIG. 5 is a side elevation view thereof showing the front, left side;

FIG. 6 is a top plan view thereof; and

FIG. 7 is a bottom plan view thereof.

FIG. 8 is a top and left side perspective of a second embodiment of a container embodying my new design;

FIG. 9 is a side elevation view thereof showing the rear, left side;

FIG. 10 is a side elevation view thereof showing the front, right side;

FIG. 11 is a side elevation view thereof showing the rear, right side;

FIG. 12 is a side elevation view thereof showing the front, left side;

FIG. 13 is a top plan view thereof; and,

FIG. 14 is a bottom plan view thereof.

The broken lines shown are included for the purpose of illustrating the unclaimed portions of the article and form no part of the claim.

**1 Claim, 12 Drawing Sheets**

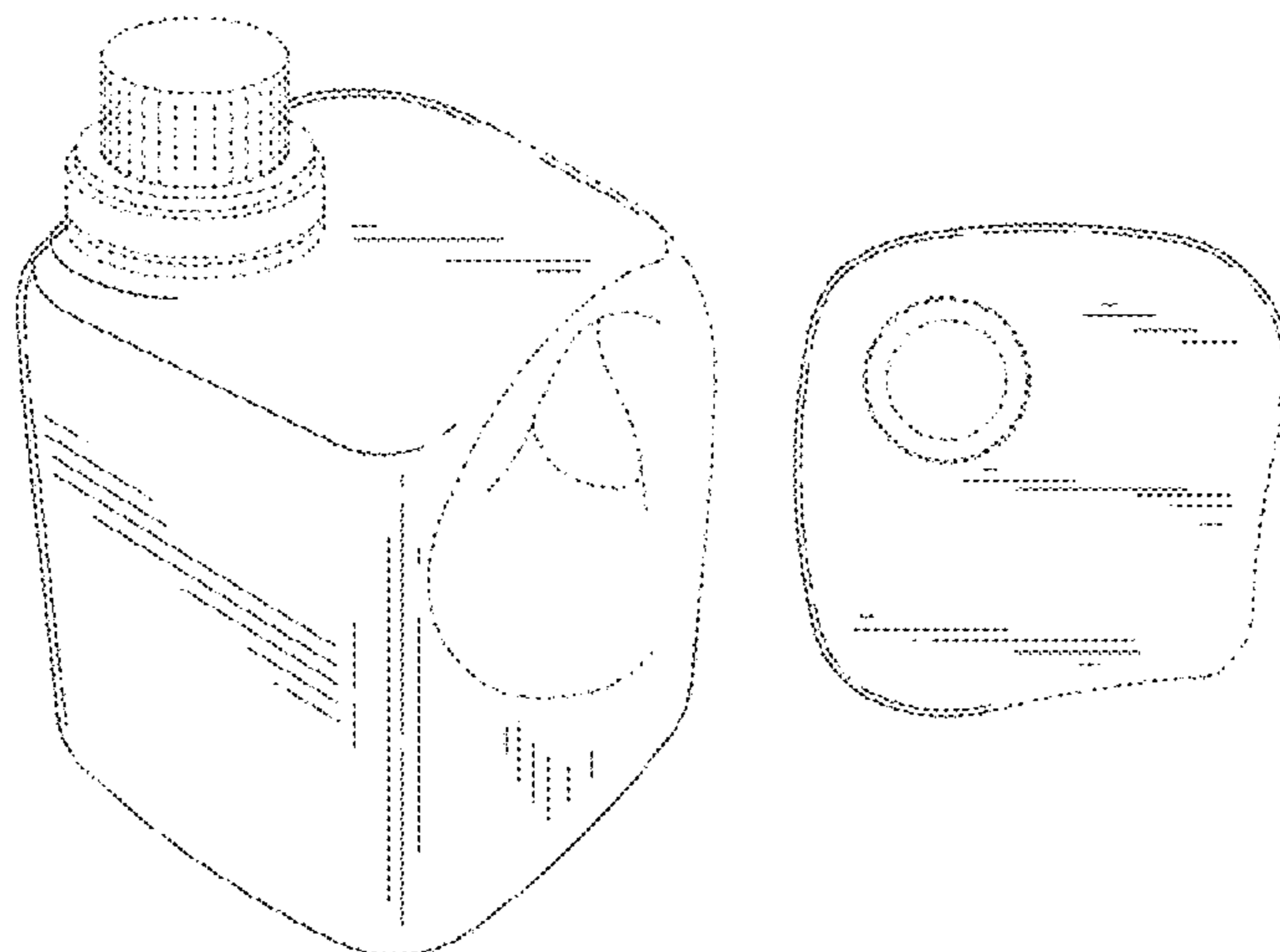

# US D668,155 S

Page 2

## U.S. PATENT DOCUMENTS

5,439,106 A 8/1995 Focke  
5,485,920 A 1/1996 Fritz  
D401,154 S 11/1998 Robinson  
5,875,958 A 3/1999 Weiteder et al.  
5,875,959 A 3/1999 Weiteder et al.  
D434,326 S 11/2000 Smorch  
6,588,612 B1 7/2003 Dorn et al.  
D482,973 S 12/2003 Nottingham et al.  
D496,865 S 10/2004 Roubal et al.  
D505,076 S 5/2005 Logan  
6,896,156 B2 5/2005 McDonald et al.  
6,932,228 B1 8/2005 Darr et al.  
D521,387 S 5/2006 Little et al.  
D528,008 S 9/2006 Lovelace, Jr. et al.  
D536,983 S 2/2007 Robinson  
D541,662 S 5/2007 Little et al.  
D543,463 S 5/2007 Young et al.  
D544,798 S 6/2007 Young et al.  
D544,799 S 6/2007 Young et al.  
D548,603 S 8/2007 Young et al.  
7,306,093 B2 12/2007 McLaughlin et al.  
7,325,687 B2 2/2008 Bravo et al.  
D573,475 S 7/2008 Nottingham et al.  
D580,768 S 11/2008 Ferguson et al.  
D653,548 S \* 2/2012 Wycoff ..... D9/528

D658,062 S \* 4/2012 Kim et al. .... D9/528  
D659,541 S \* 5/2012 Wycoff ..... D9/528  
2003/0132184 A1 7/2003 Dorn et al.  
2006/0261030 A1 11/2006 Manderfield, Jr.  
2007/0187412 A1 8/2007 Gruskin et al.  
2007/0187420 A1 8/2007 Gruskin et al.  
2007/0289939 A1 12/2007 Young et al.  
2008/0217200 A1 9/2008 Eiten et al.

## OTHER PUBLICATIONS

U.S. Appl. No. 61/278,752, filed Oct. 9, 2009.  
U.S. Appl. No. 12/804,556, filed Jul. 22, 2010.  
Simplicity Products International, Inc., US Trademark Application  
Serial No. 77/593,505.  
Sustainable Is Good. Concentrated Laundry Detergents Become  
Trend in Green Retail Packaging; website, [www.sustainableisgood.com/blog/2007/09/concentrated-la.html](http://www.sustainableisgood.com/blog/2007/09/concentrated-la.html), posted Sep. 6, 2007.  
Thompson, Sam's Club Square Case-less Milk Jug Packaging, [www.sustainableisgood.com/blog/packaging\\_design\\_innovation/](http://www.sustainableisgood.com/blog/packaging_design_innovation/),  
posted 07/01/2008.  
U.S. Appl. No. 29/345,205, filed Oct. 12, 2009, now United States  
patent No. D653,548, issued Feb. 7, 2012.  
U.S. Appl. No. 29/408,879, filed Dec. 16, 2011.

\* cited by examiner

FIG. 1

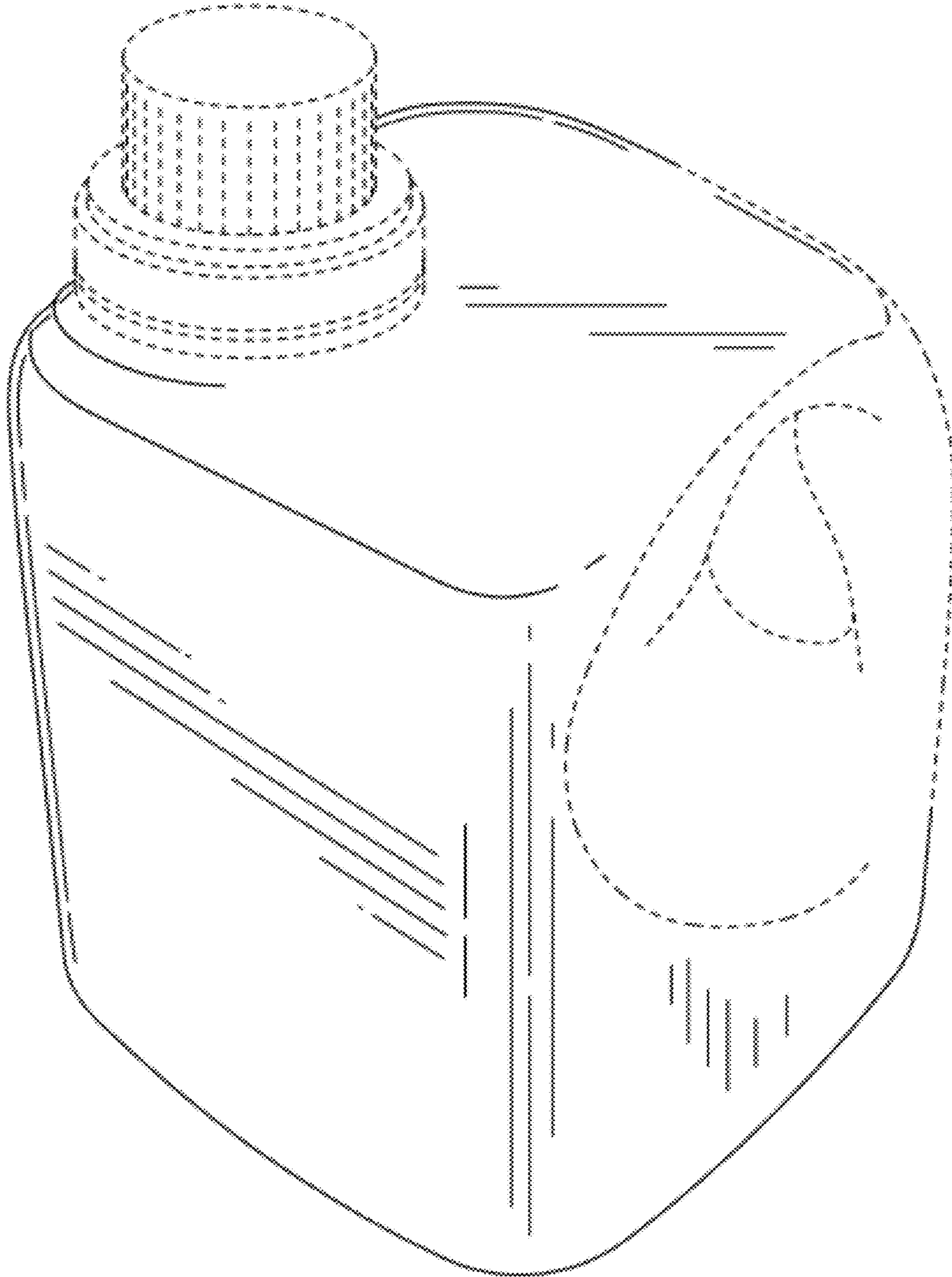

FIG. 2

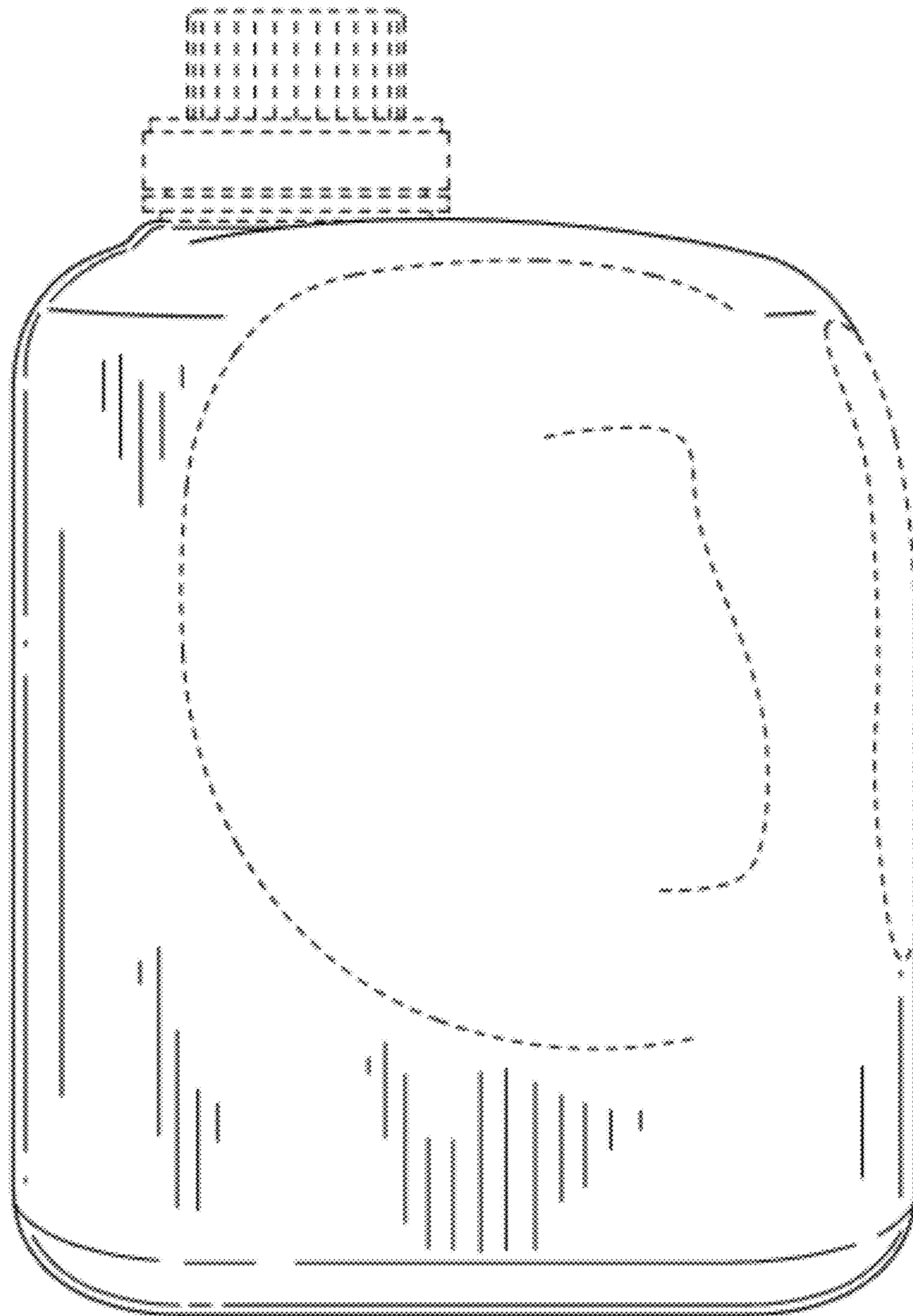

FIG. 3

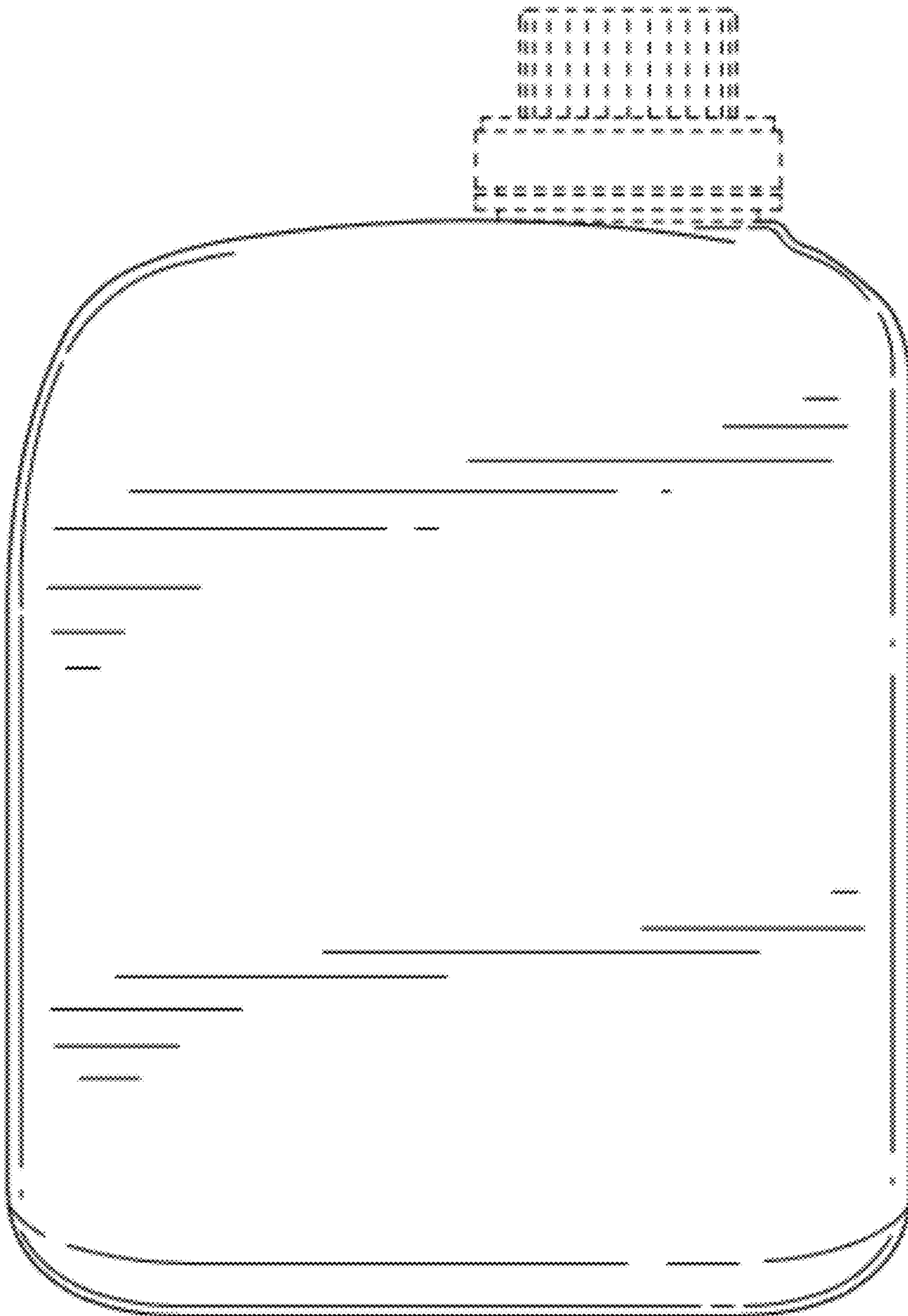

FIG. 4

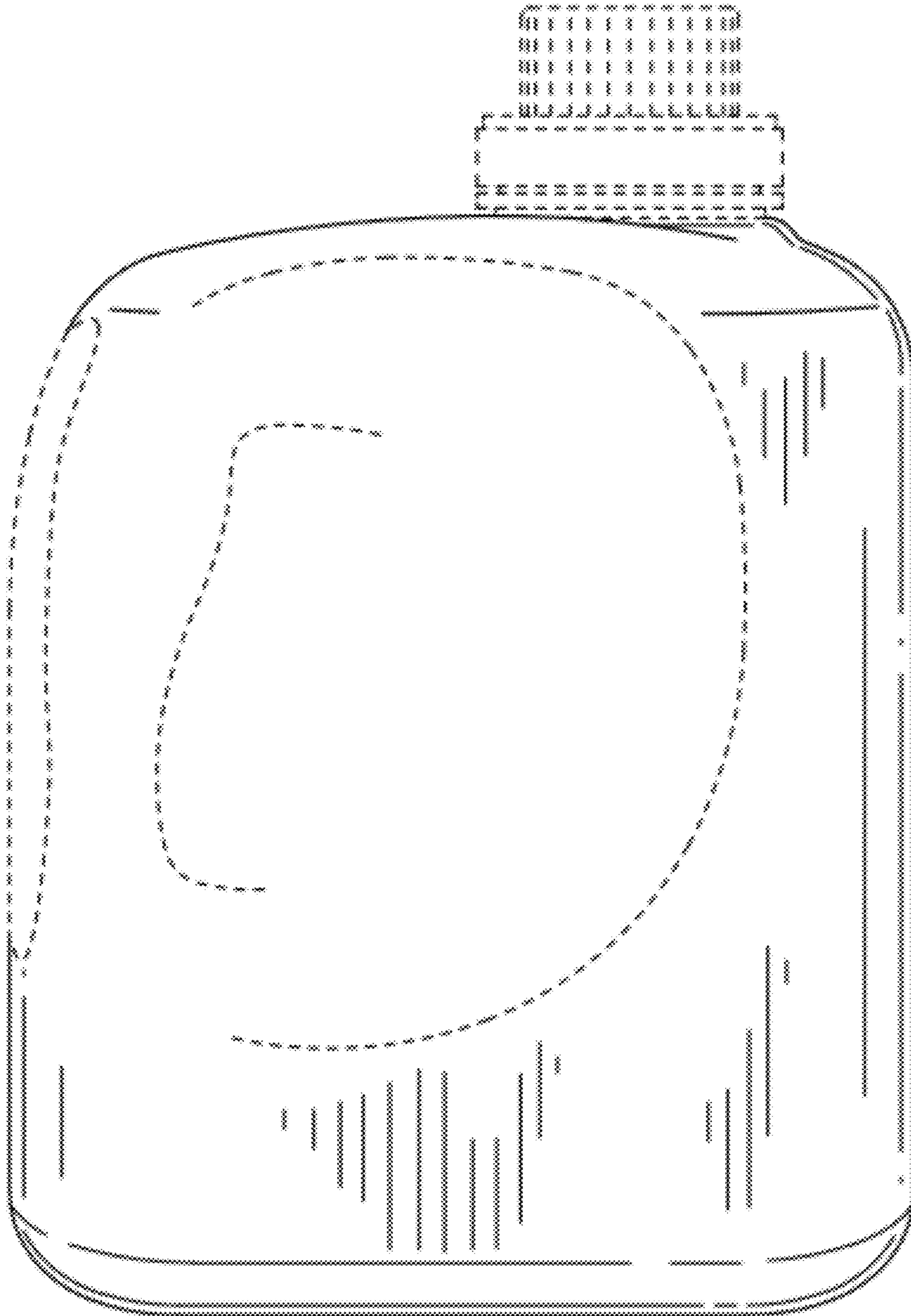

FIG. 5

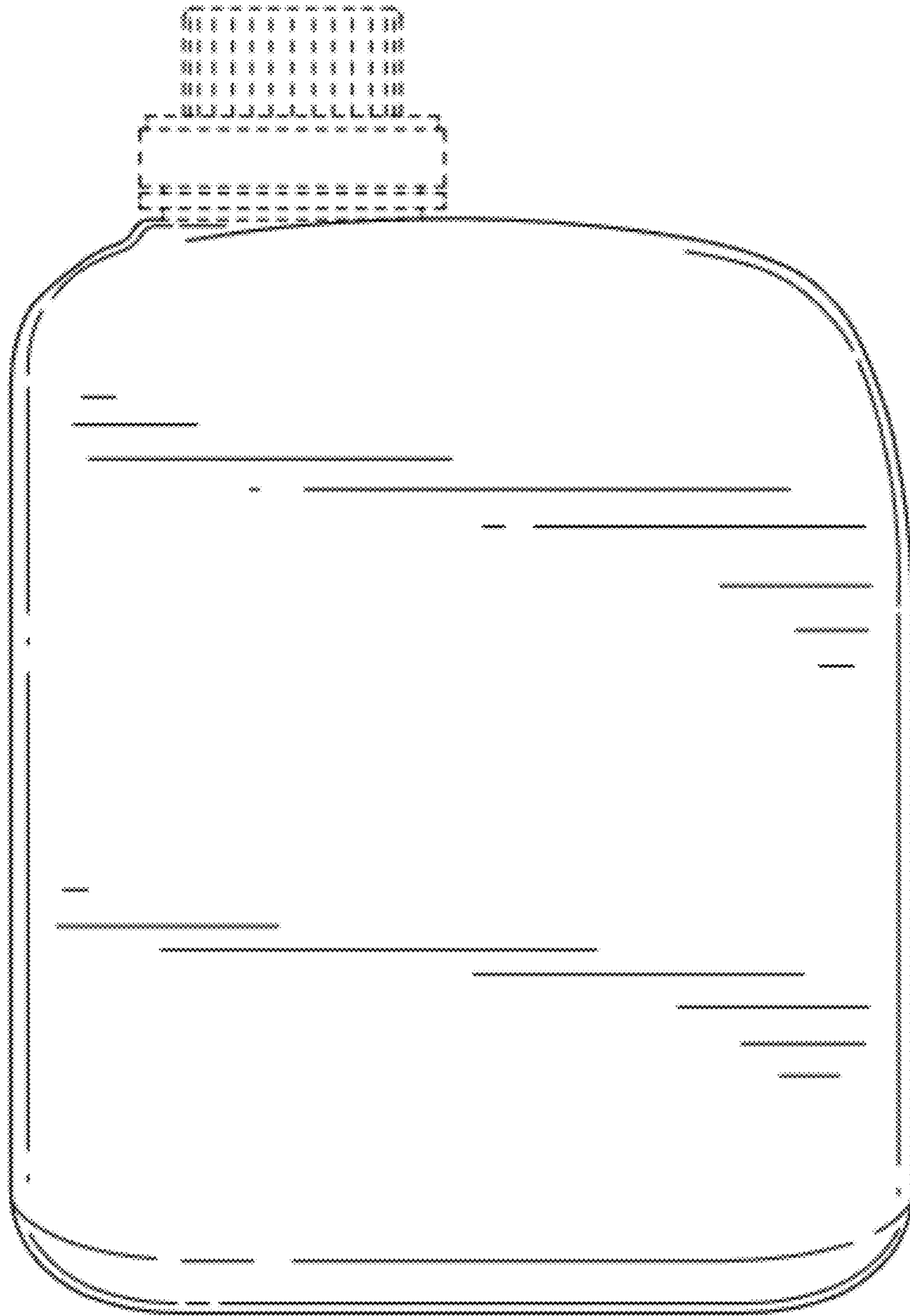

FIG. 6

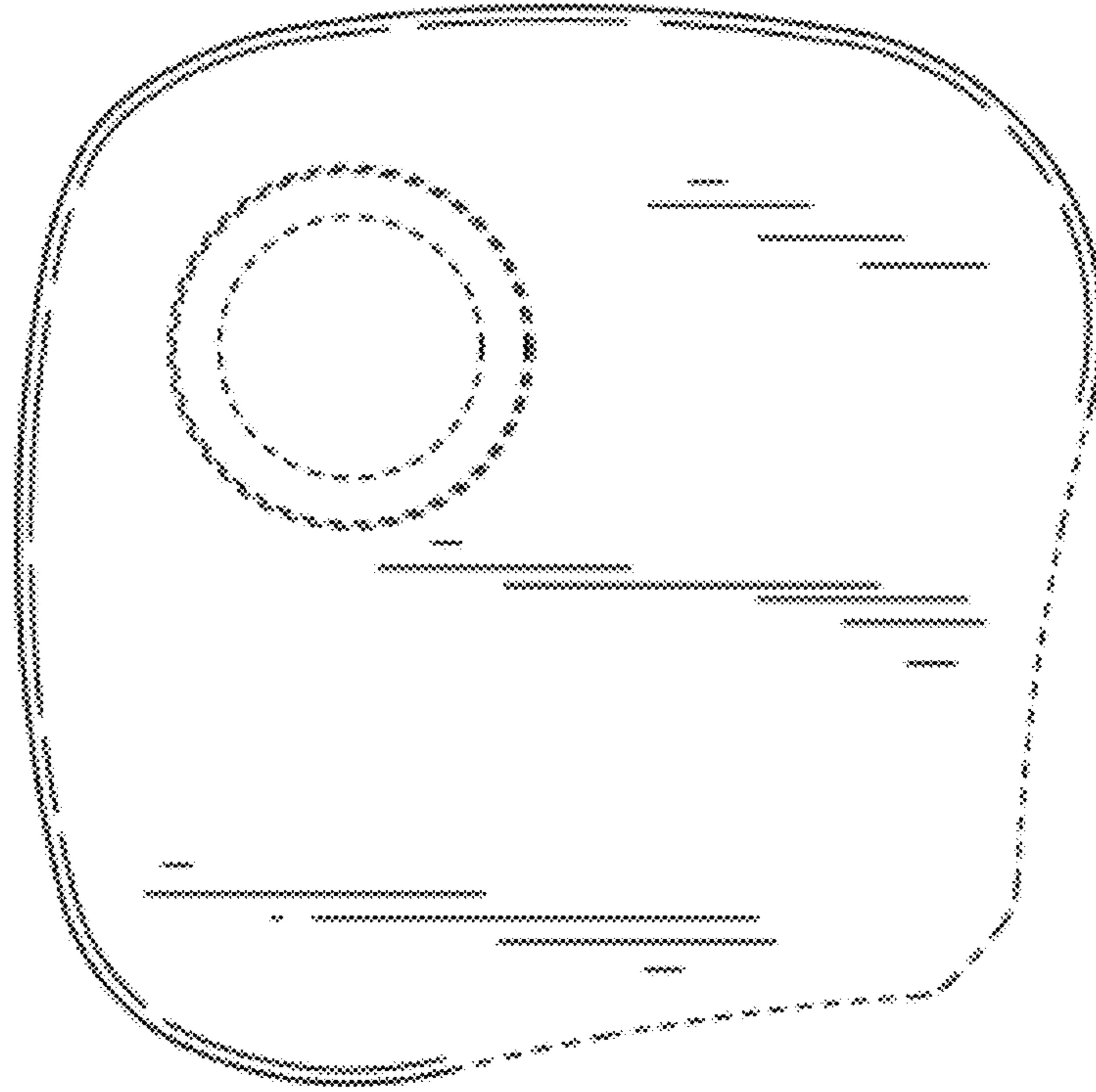
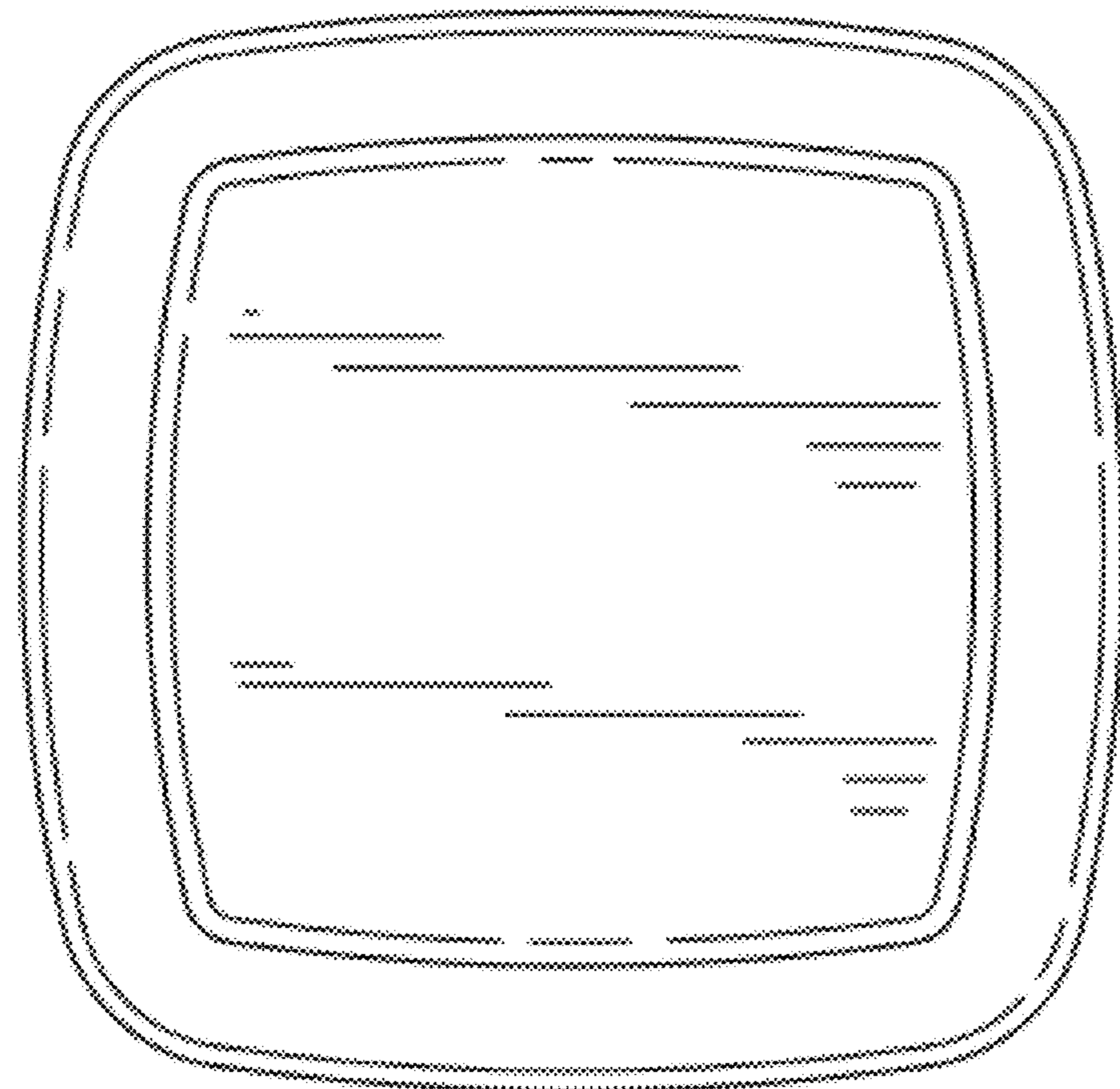

FIG. 7





*FIG. 8*

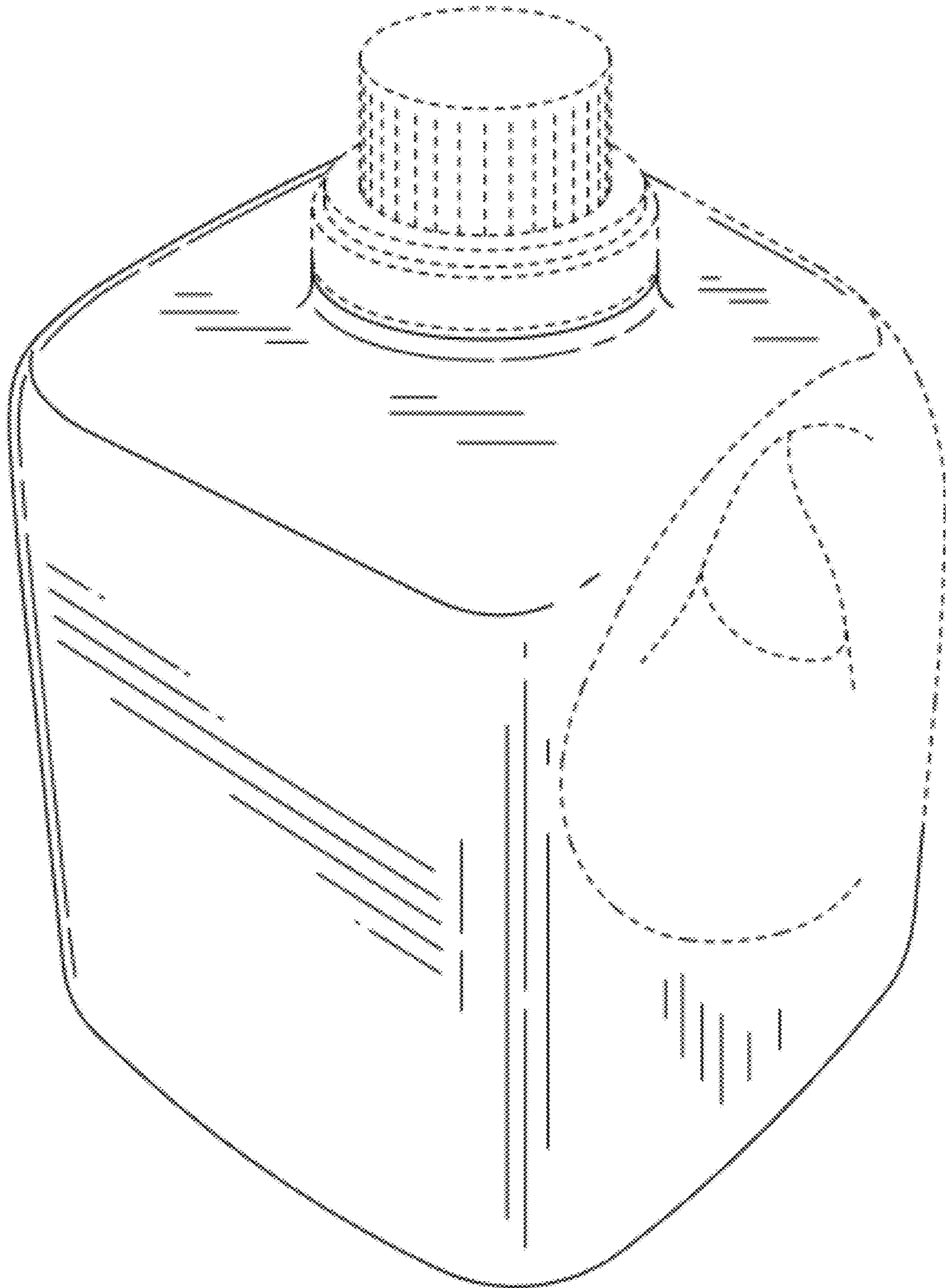

FIG. 9

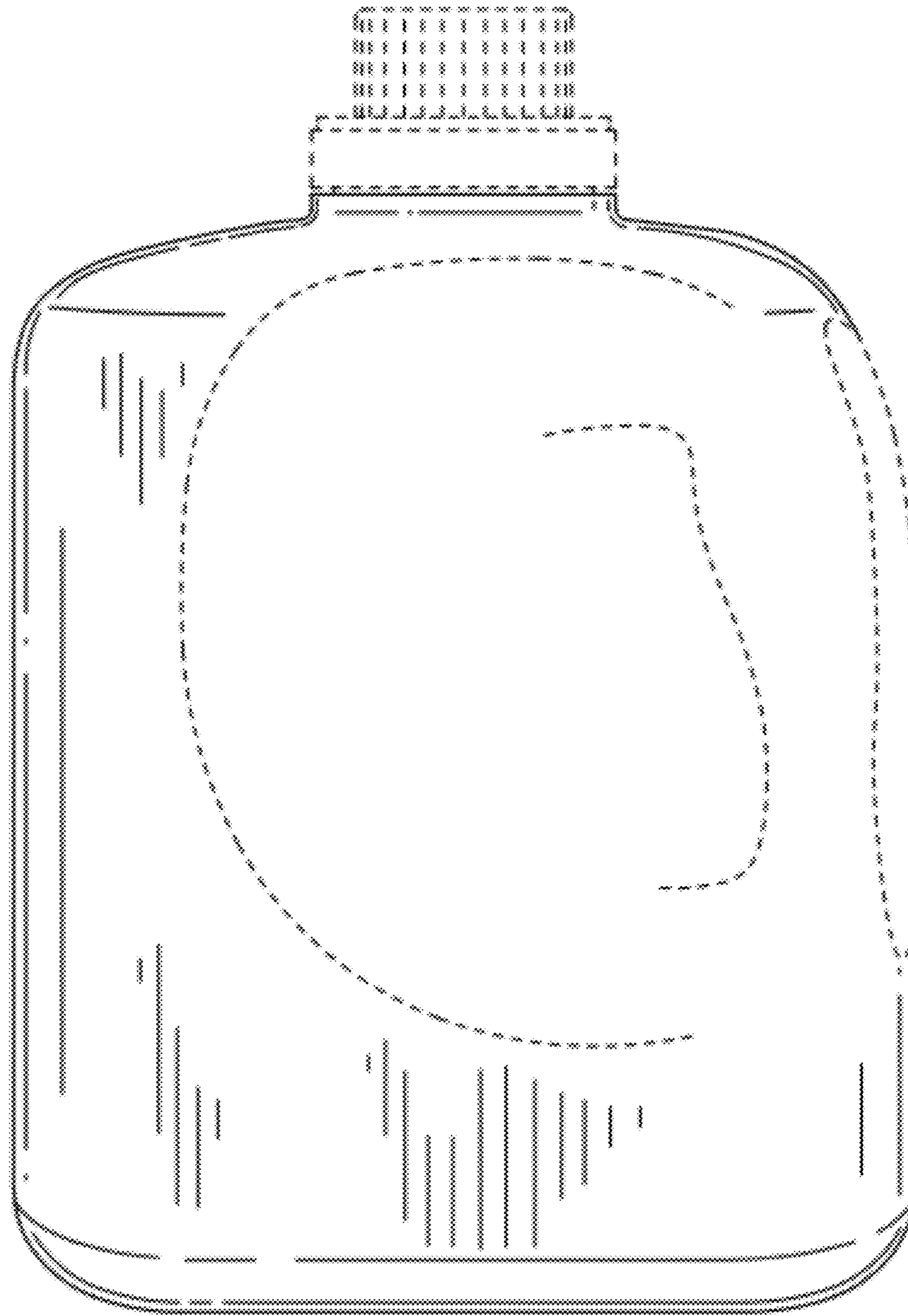

FIG. 10

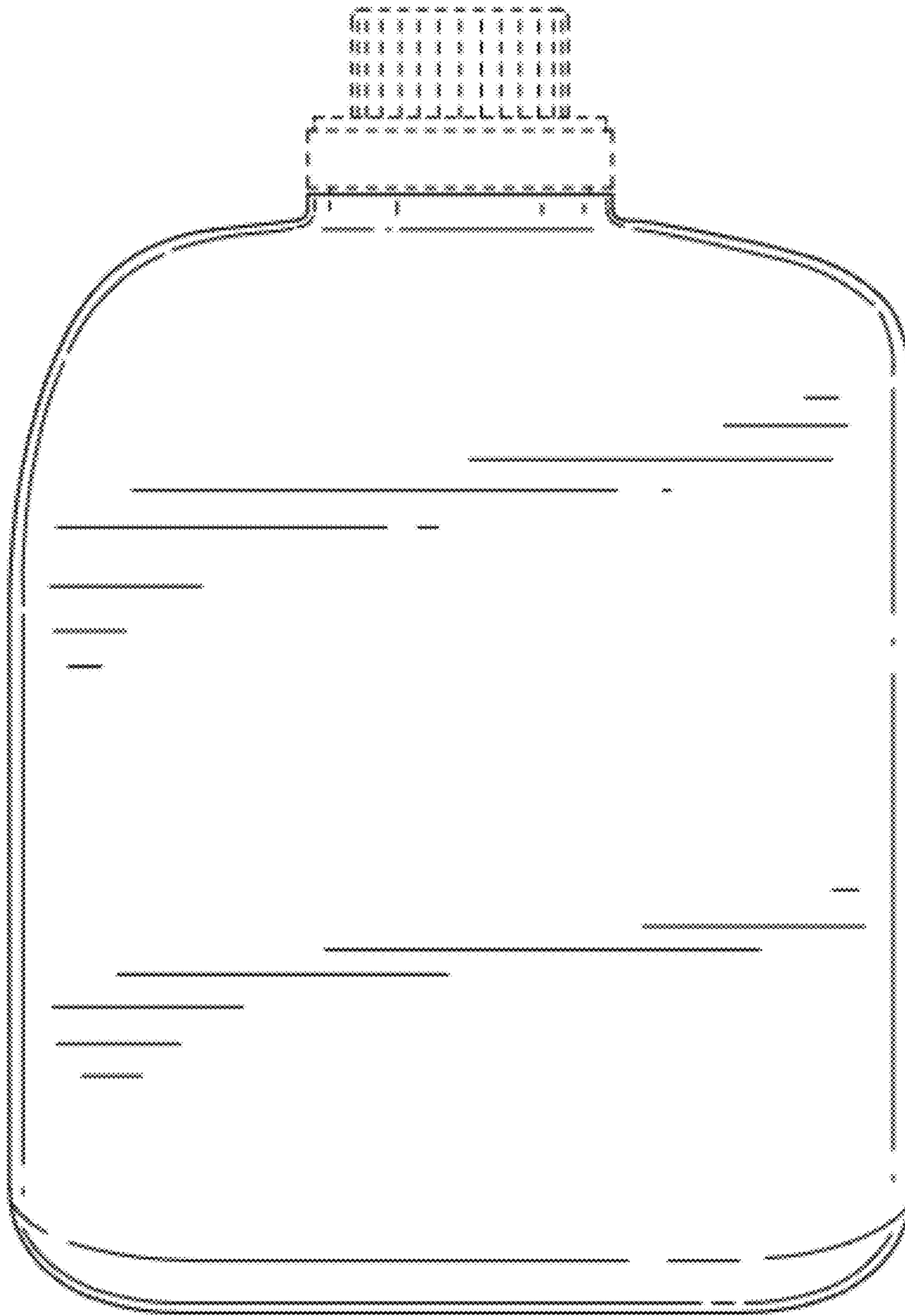

FIG. 11

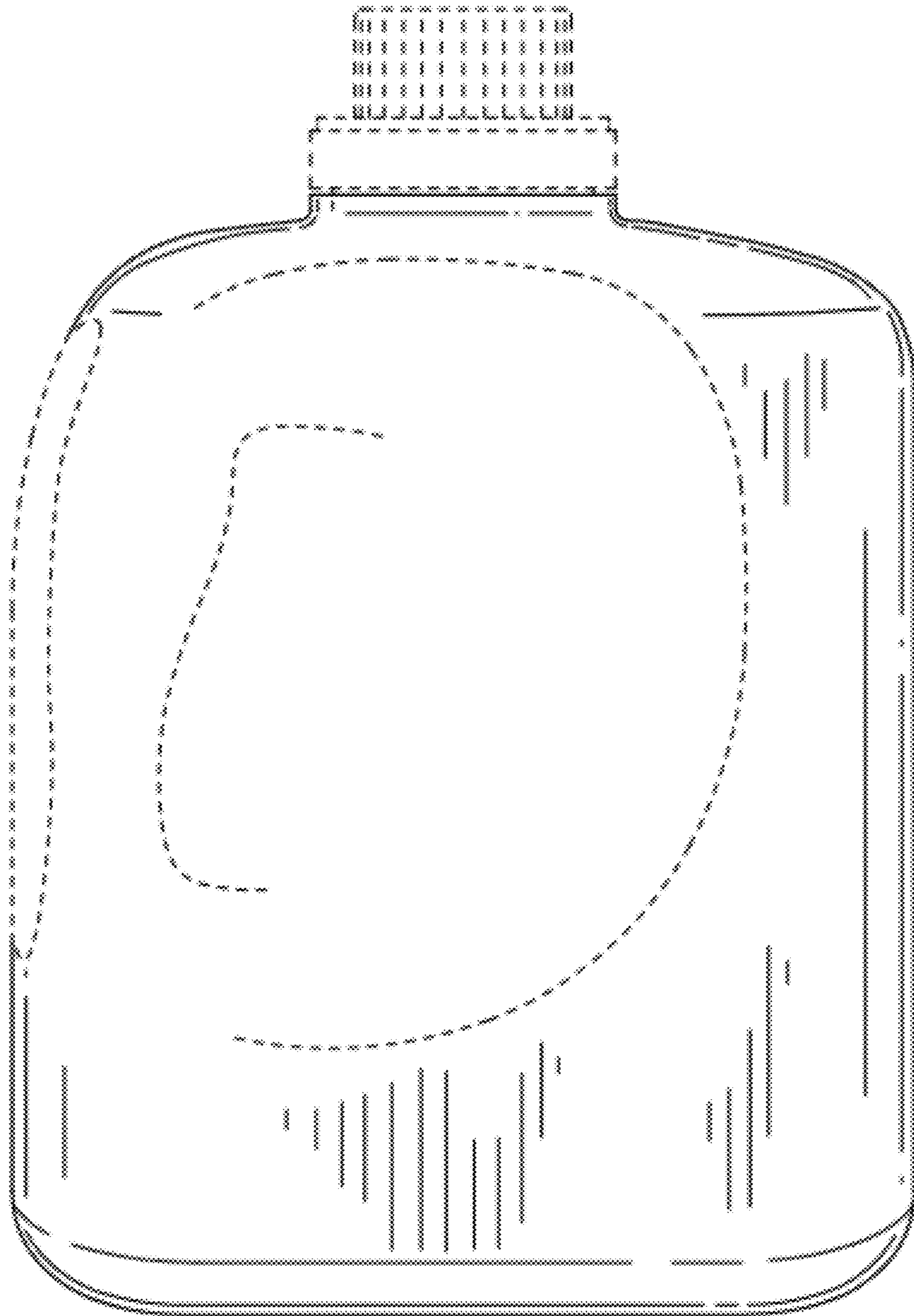

FIG. 12



FIG. 13

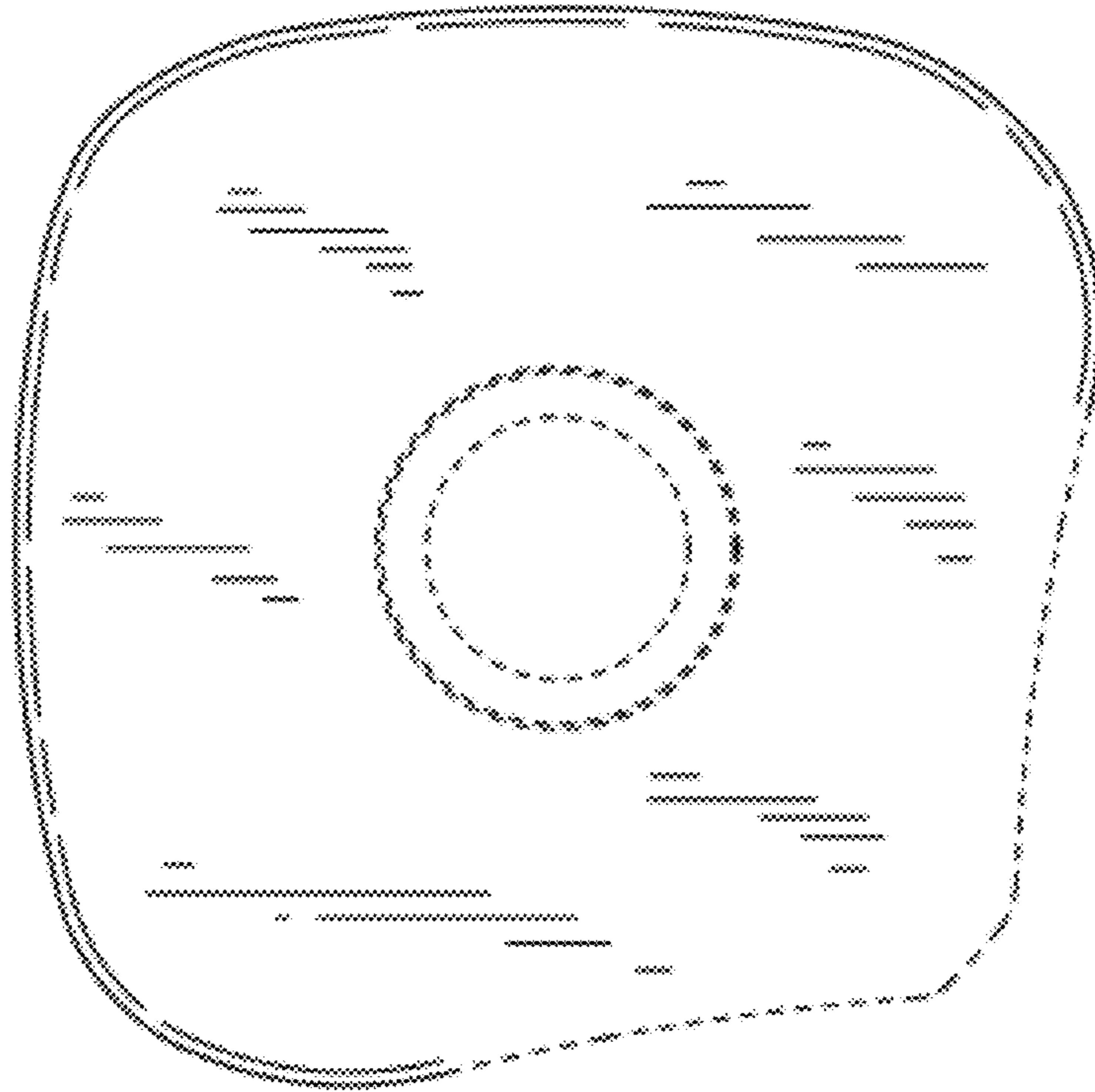

FIG. 14

