

US00D668127S

(12) **United States Design Patent**
Yang

(10) **Patent No.:** **US D668,127 S**

(45) **Date of Patent:** **** Oct. 2, 2012**

(54) **CLAMP**

(76) Inventor: **Ching-Chen Yang**, Taichung (TW)

(**) Term: **14 Years**

(21) Appl. No.: **29/415,899**

(22) Filed: **Mar. 15, 2012**

(51) **LOC (9) Cl.** **08-05**

(52) **U.S. Cl.** **D8/72**

(58) **Field of Classification Search** D8/71-74,
D8/394, 59; 248/62, 63, 72, 74.1, 689, 124.2;
81/487; 269/3, 4, 6, 143, 165, 240, 243,
269/246-249, 254 R, 147-149; 29/256,
29/257, 276; D15/140; 408/103, 104-109;
D6/400

See application file for complete search history.

(56) **References Cited**

U.S. PATENT DOCUMENTS

D320,919 S *	10/1991	Sorensen	D8/72
D488,043 S *	4/2004	Ben-Gigi	D8/72
D494,828 S *	8/2004	Phillips	D8/72
D516,892 S *	3/2006	Ping	D8/72
7,017,894 B1 *	3/2006	Lin	269/6

D541,613 S *	5/2007	Wang	D8/74
D541,614 S *	5/2007	Wang	D8/74
D545,162 S *	6/2007	Ranieri	D8/73
D555,454 S *	11/2007	Noniewicz	D8/72
D597,814 S *	8/2009	Yang	D8/72
D619,441 S *	7/2010	Yang	D8/72
D622,121 S *	8/2010	Weinberg et al.	D8/72
7,954,794 B2 *	6/2011	Fuller et al.	269/6

* cited by examiner

Primary Examiner — David Muller

(57) **CLAIM**

The ornamental design for a clamp, as shown and described.

DESCRIPTION

FIG. 1 is a perspective view of a clamp showing my new design;

FIG. 2 is a left side view thereof;

FIG. 3 is a right side view thereof;

FIG. 4 is a front view thereof;

FIG. 5 is a rear view thereof;

FIG. 6 is a top view thereof; and,

FIG. 7 is a bottom view thereof.

The features shown in broken lines depict environmental subject matter only and form no part of the claimed design.

1 Claim, 5 Drawing Sheets

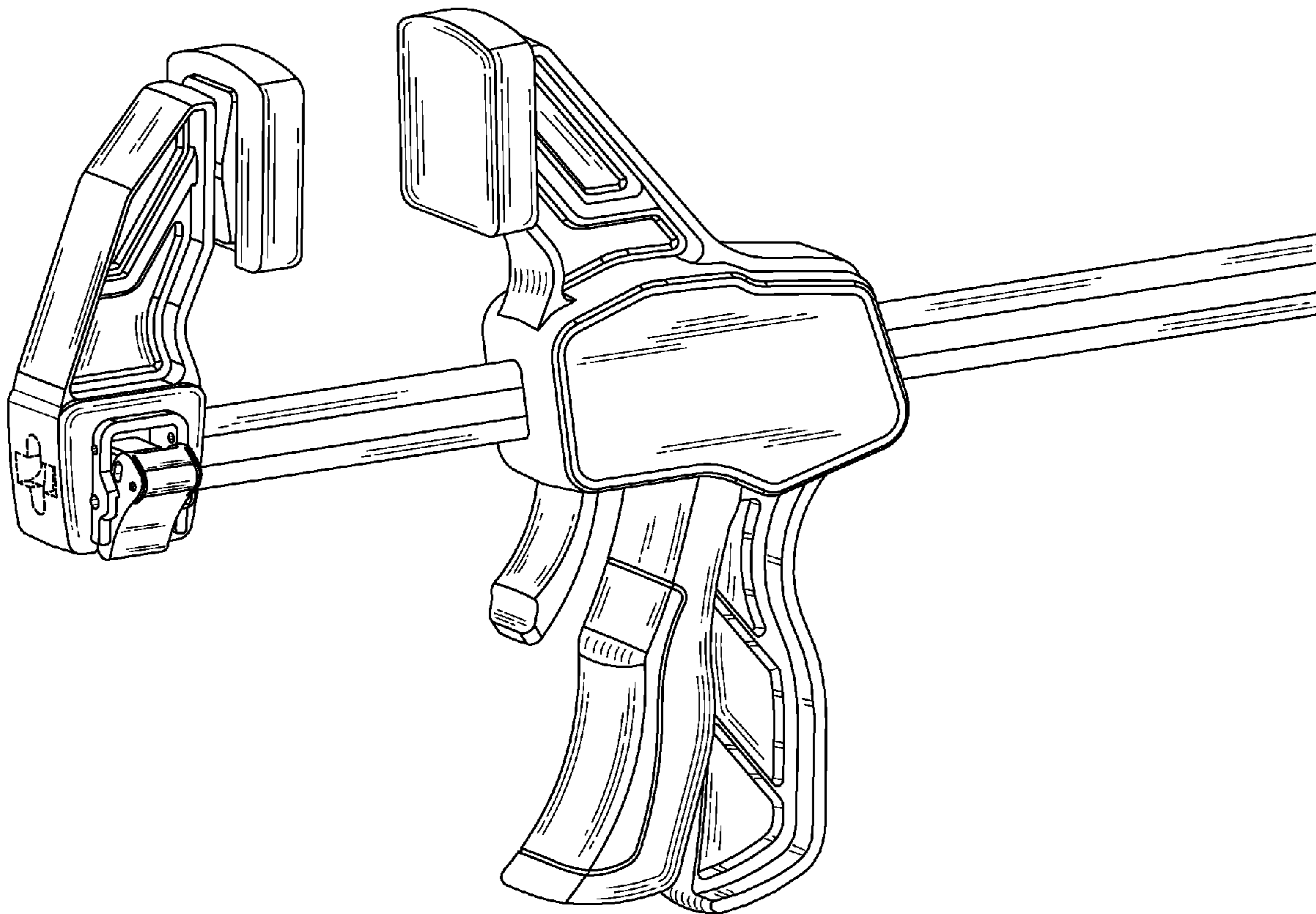

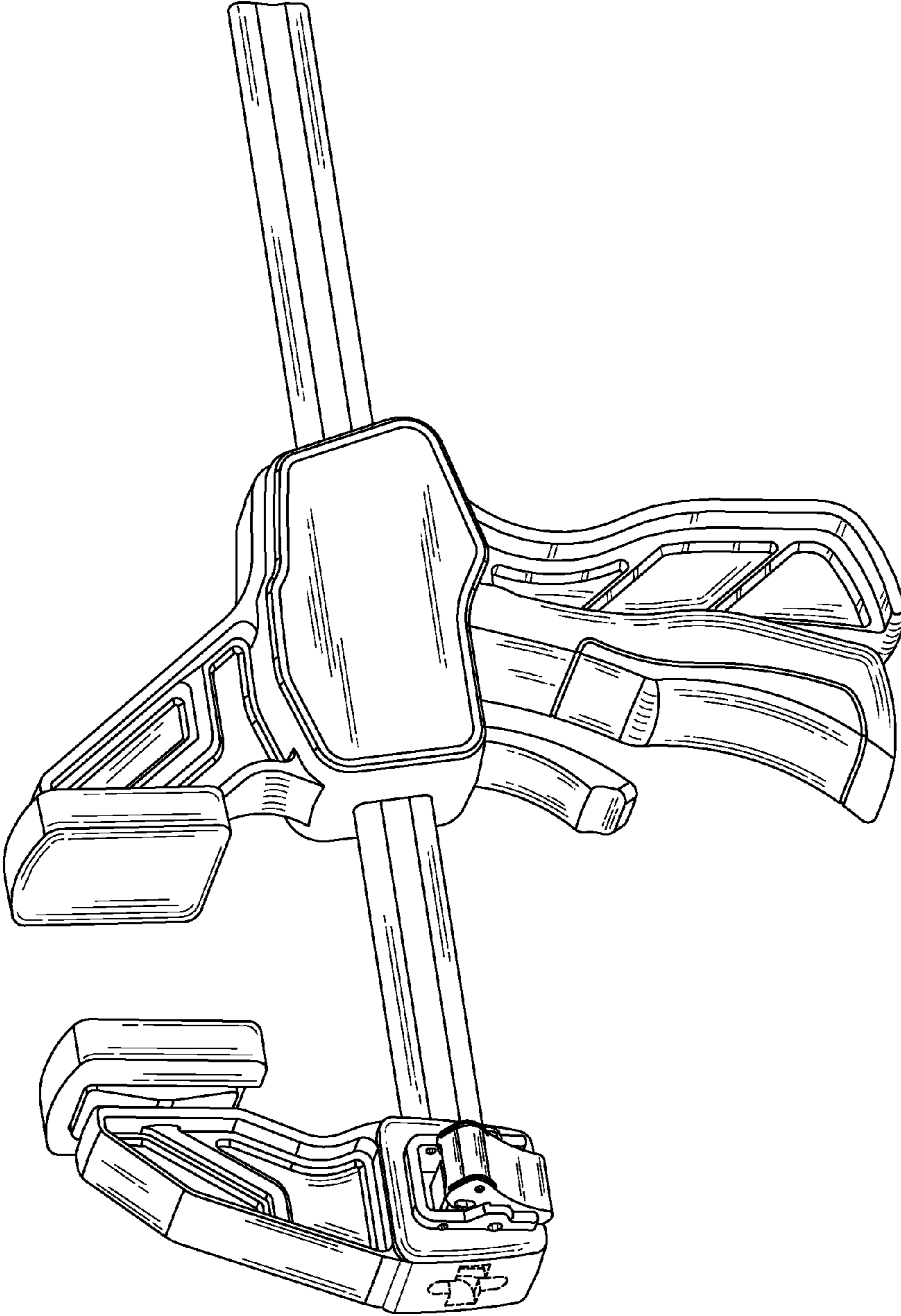

FIG. 1

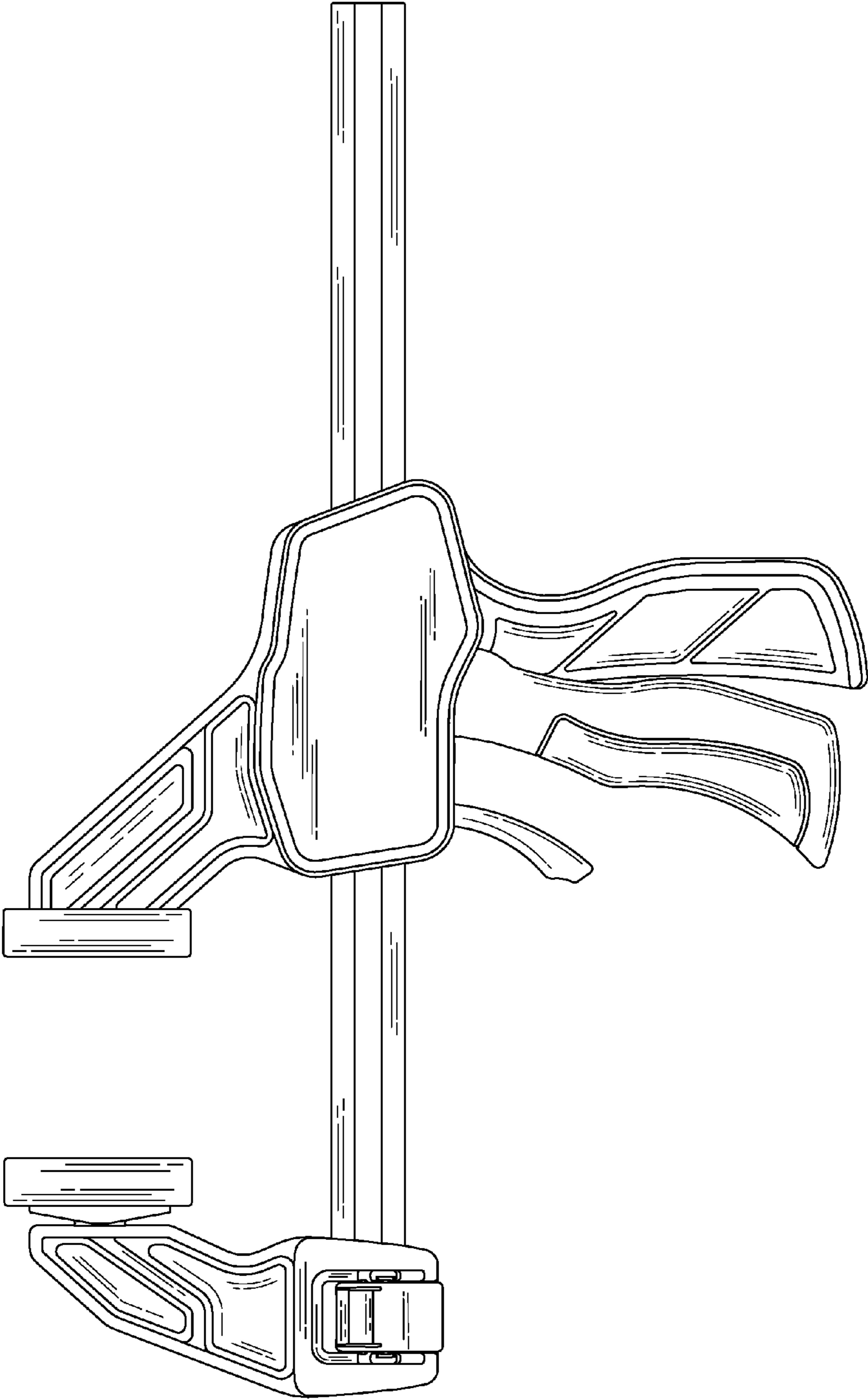

FIG. 2

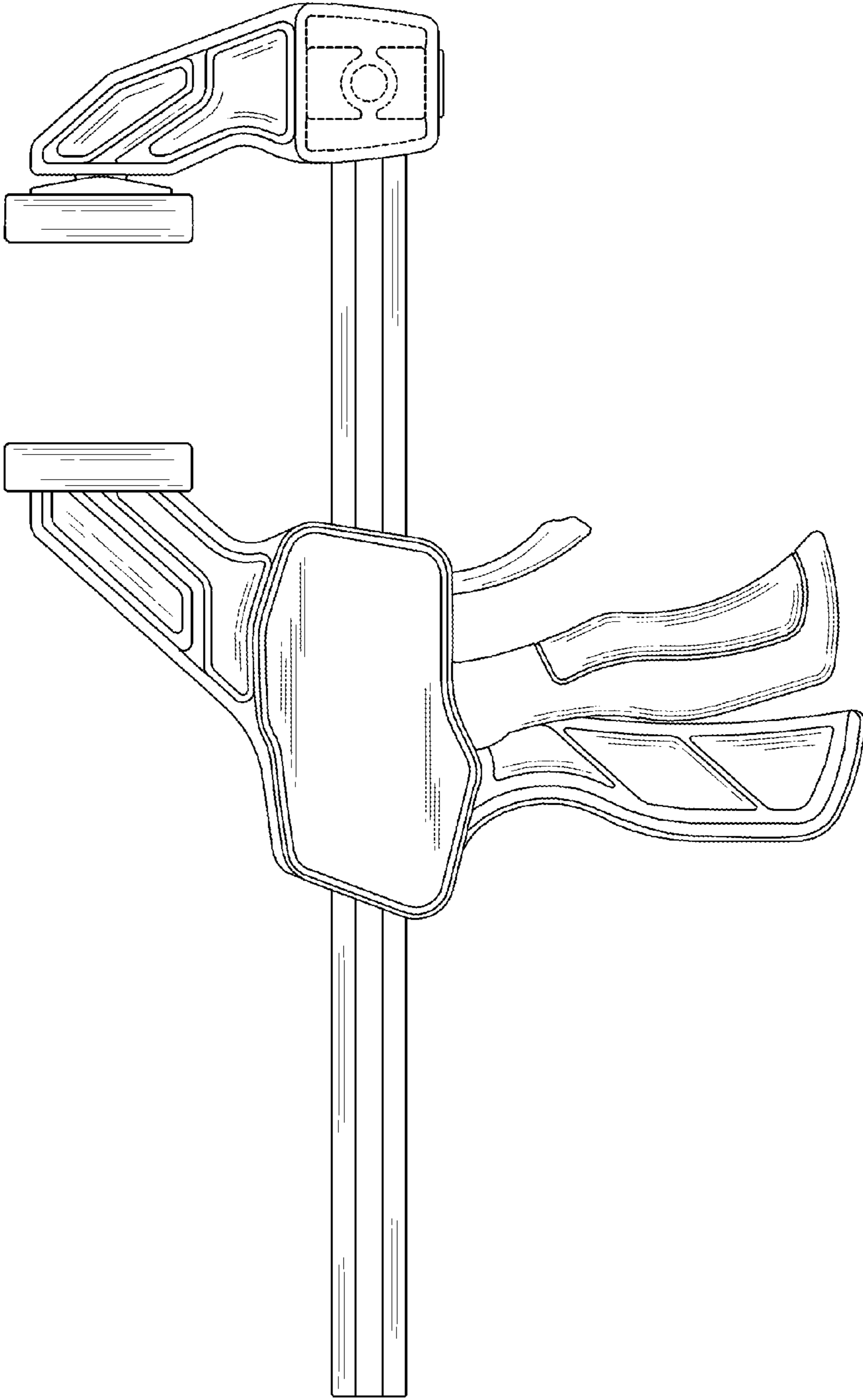

FIG. 3

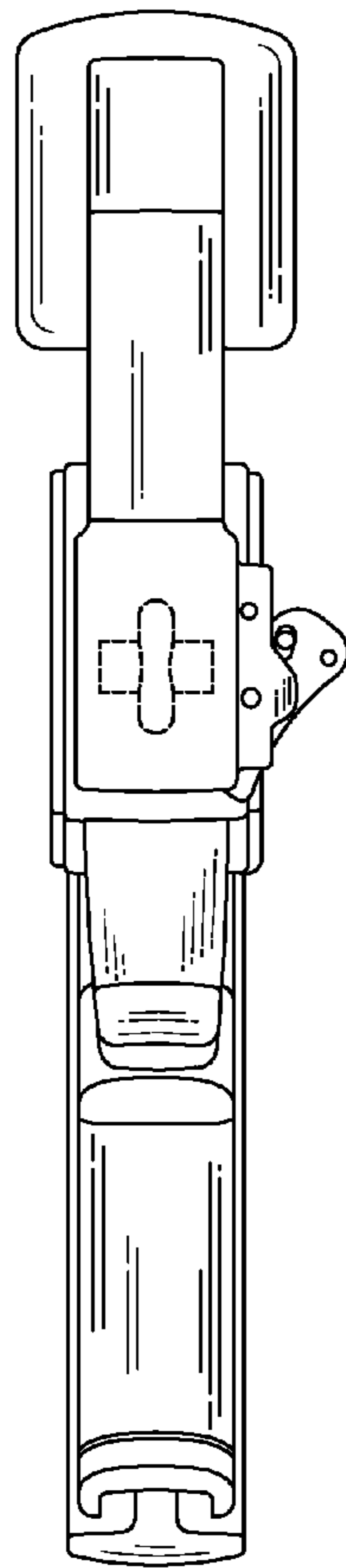

FIG. 4

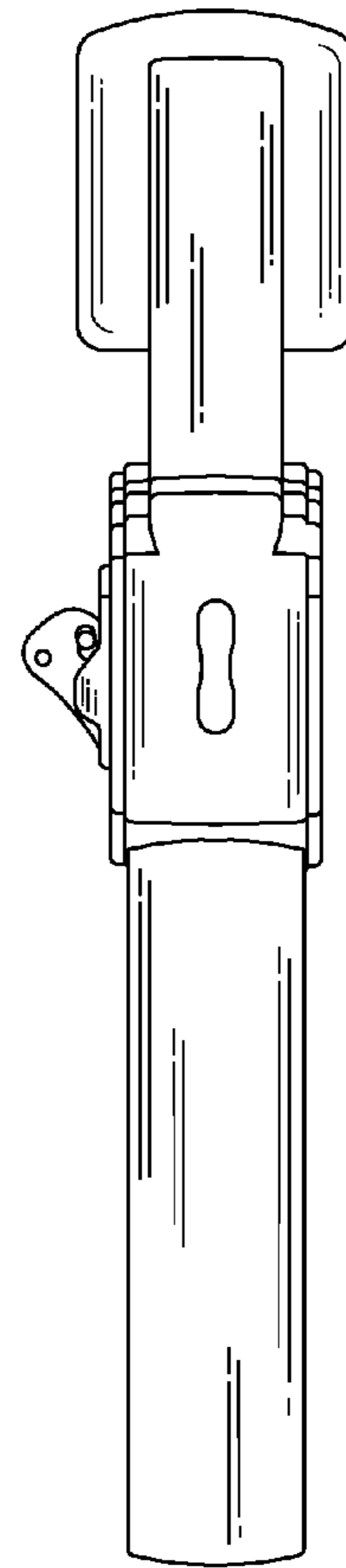

FIG. 5

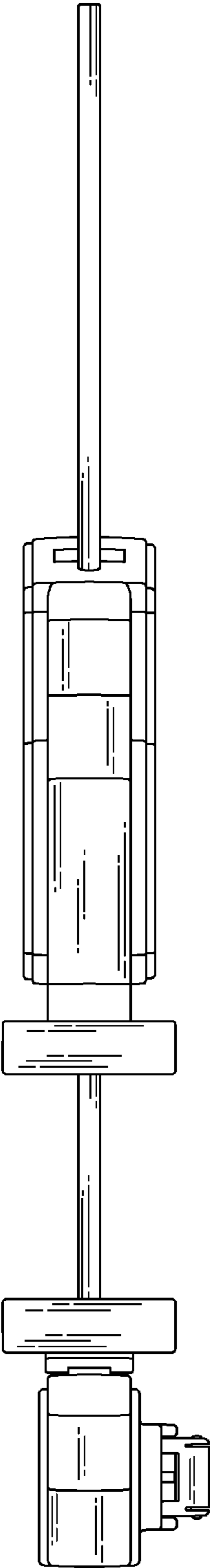

FIG. 6

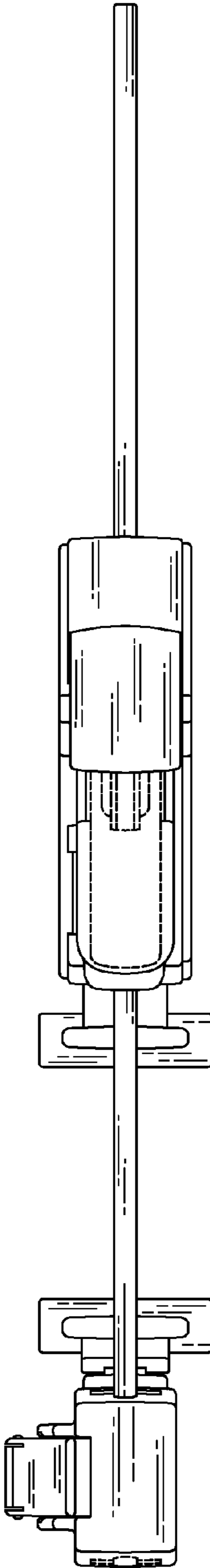

FIG. 7