



US00D668089S

(12) **United States Design Patent**
Afghan et al.

(10) **Patent No.:** **US D668,089 S**
(45) **Date of Patent:** **** Oct. 2, 2012**

(54) **SANITARY TOOTHBRUSH HOLDER**

(76) Inventors: **Farzana Ayubi Afghan**, Lawrenceville, GA (US); **M. Farad Afghan**, Lawrenceville, GA (US)

(**) Term: **14 Years**

(21) Appl. No.: **29/415,311**

(22) Filed: **Mar. 9, 2012**

Related U.S. Application Data

(63) Continuation of application No. 12/612,316, filed on Nov. 4, 2009, now Pat. No. 8,132,681.

(51) **LOC (9) Cl.** **23-02**

(52) **U.S. Cl.** **D6/534**

(58) **Field of Classification Search** D6/524, D6/526, 527, 528, 534; 206/208, 228, 209, 206/209.1, 361, 362, 362.1, 362.2, 362.3; 211/13.1, 66, 70.6, 86.01, 87.01, 60.1, 65, 211/85.13, 119.009, 89.01

See application file for complete search history.

(56) **References Cited**

U.S. PATENT DOCUMENTS

D41,679 S *	8/1911	Sternau	D6/534
D43,289 S *	11/1912	Sternau	D6/548
2,730,243 A *	1/1956	Platt	211/60.1
D403,236 S *	12/1998	McBarnette	D8/372
D454,740 S *	3/2002	Baggott	D6/534
D485,157 S *	1/2004	Rodrigue	D8/372
D486,380 S *	2/2004	McDaniel	D8/372
D498,958 S *	11/2004	Henry	D6/534
D600,538 S *	9/2009	Thompson et al.	D8/372
D633,372 S *	3/2011	Ayrest	D8/372

* cited by examiner

Primary Examiner — Brian N Vinson

(74) *Attorney, Agent, or Firm* — Ryan A. Schneider, Esq.; Troutman Sanders LLP

(57) **CLAIM**

The ornamental design for a sanitary toothbrush holder, as shown and described.

DESCRIPTION

FIG. 1 is a front view of a sanitary toothbrush holder of the present invention;

FIG. 2 is a rear view of the sanitary toothbrush holder of FIG. 1;

FIG. 3 is a top view of the sanitary toothbrush holder of FIG. 1;

FIG. 4 is a bottom view of the sanitary toothbrush holder of FIG. 1;

FIG. 5 is a side view of the sanitary toothbrush holder of FIG. 1;

FIG. 6 is the other side view of the sanitary toothbrush holder of FIG. 1;

FIG. 7 is a front perspective view of the sanitary toothbrush holder of FIG. 1;

FIG. 8 is a front view of a sanitary toothbrush holder of another embodiment of the present invention;

FIG. 9 is a rear view of the sanitary toothbrush holder of FIG. 8;

FIG. 10 is a top view of the sanitary toothbrush holder of FIG. 8;

FIG. 11 is a bottom view of the sanitary toothbrush holder of FIG. 8;

FIG. 12 is a side view of the sanitary toothbrush holder of FIG. 8;

FIG. 13 is the other side view of the sanitary toothbrush holder of FIG. 8; and,

FIG. 14 is a front perspective view of the sanitary toothbrush holder of FIG. 8.

The broken lines showing mounting holes, peg rims, and toothbrushes in one or more of FIGS. 1-2, 7-9, and 14 are for the purpose of illustrating exemplary mounting holes, peg rims, and toothbrushes, and form no part of the claimed design.

1 Claim, 14 Drawing Sheets

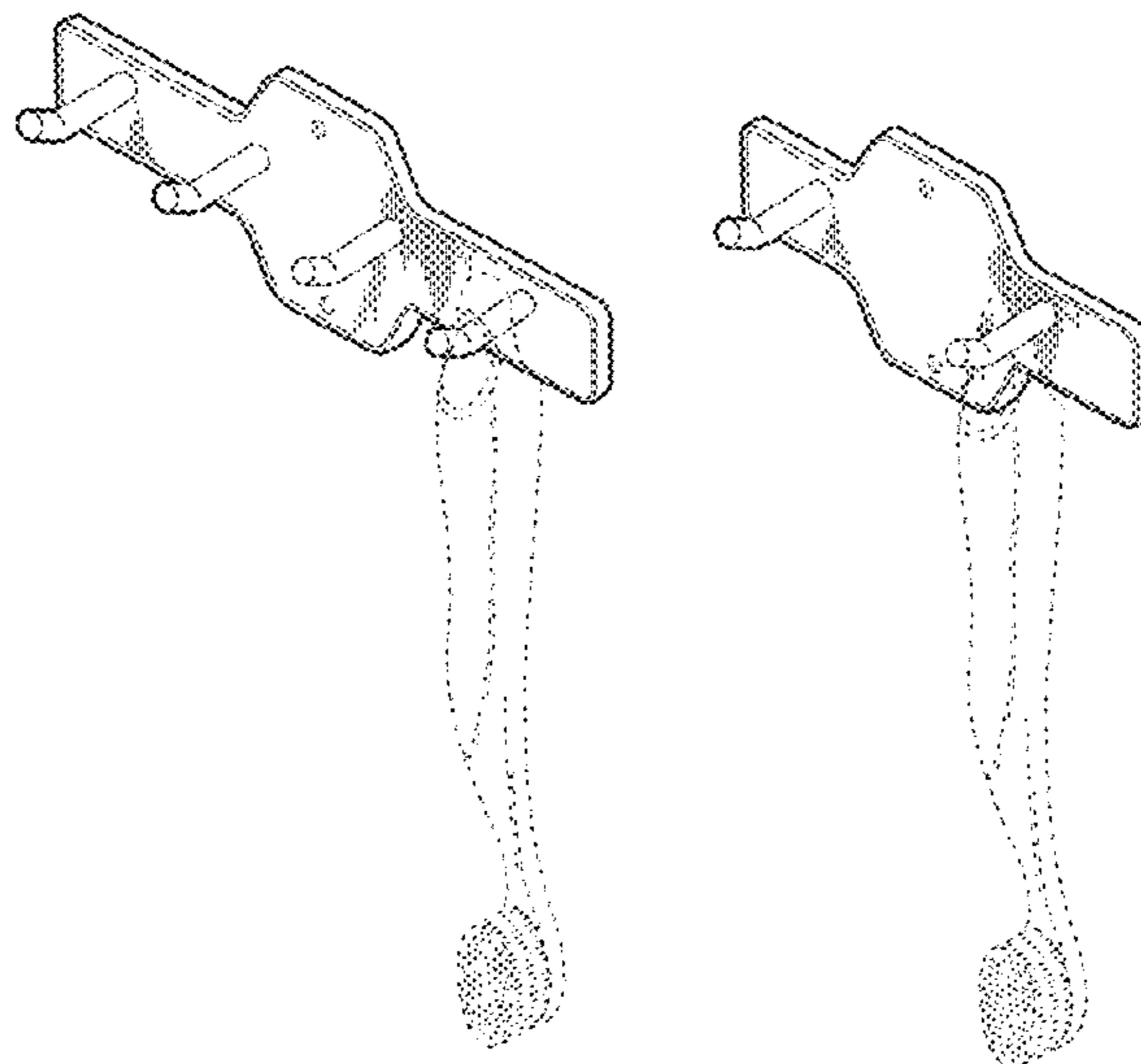

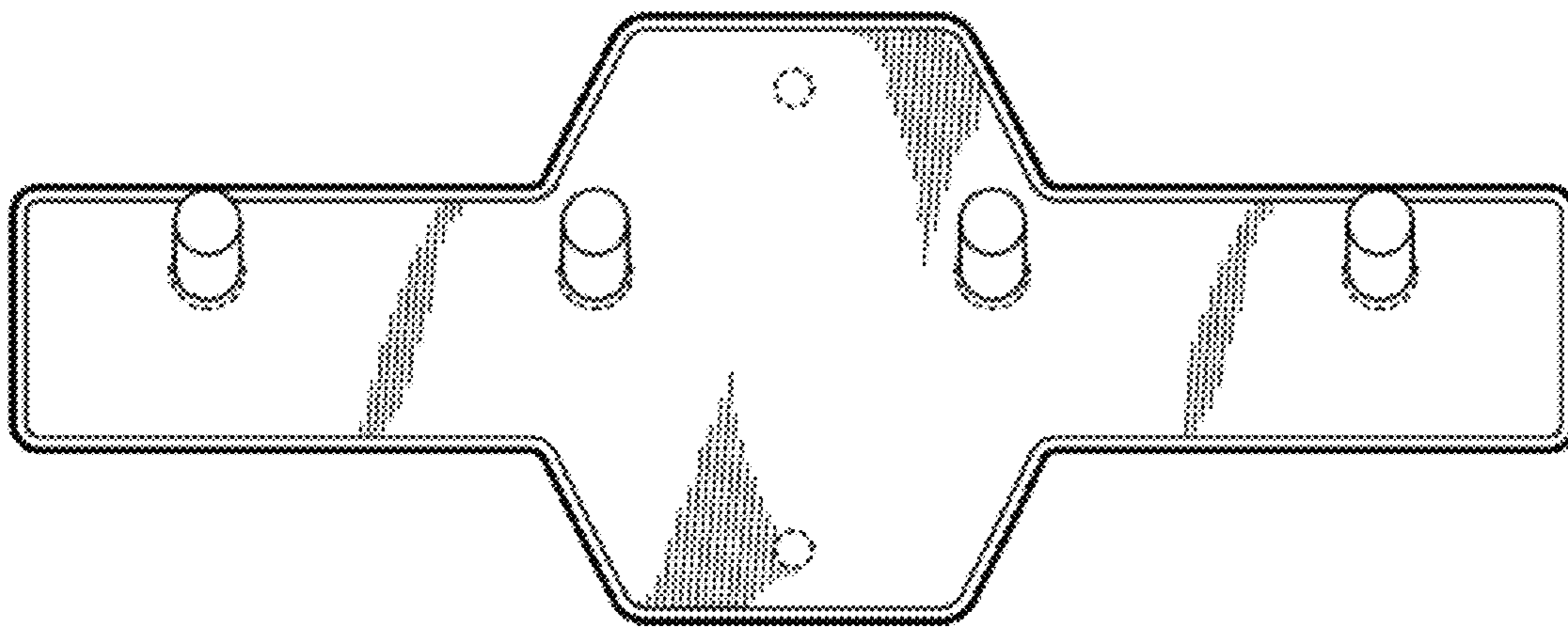

Fig. 1

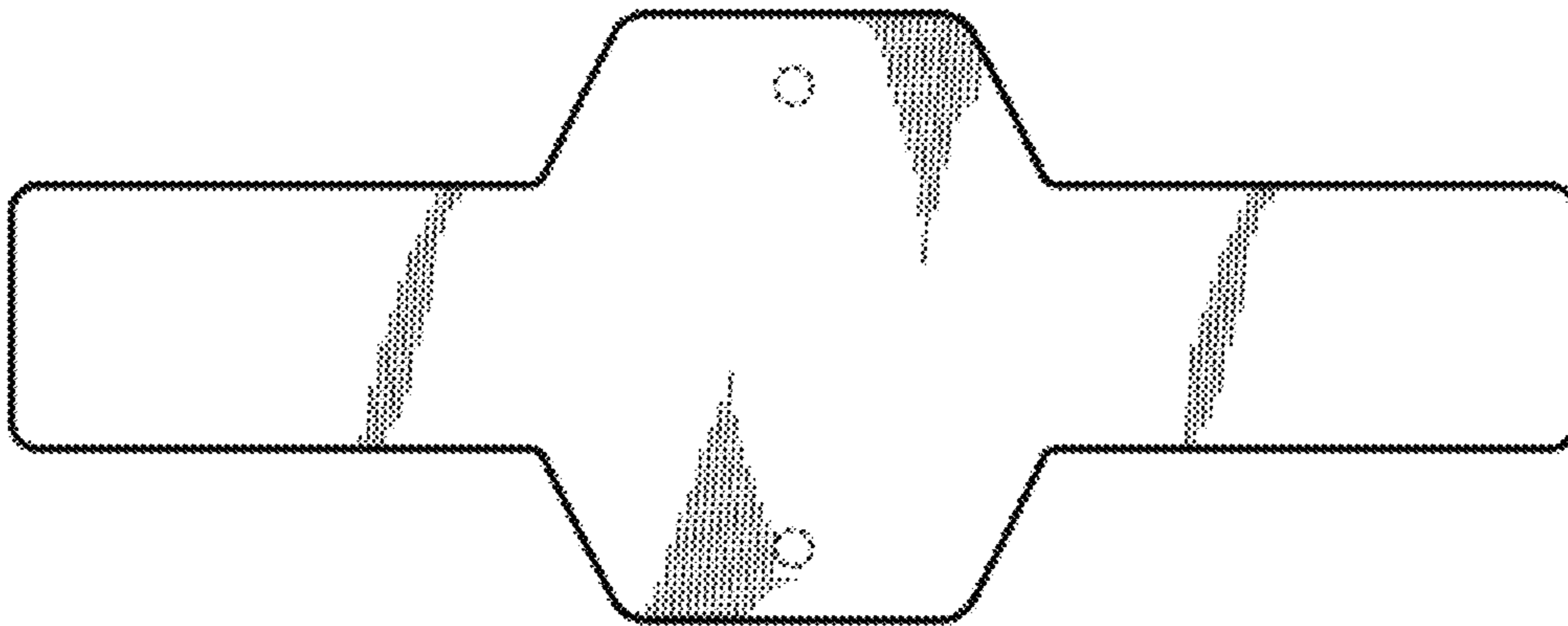

Fig. 2

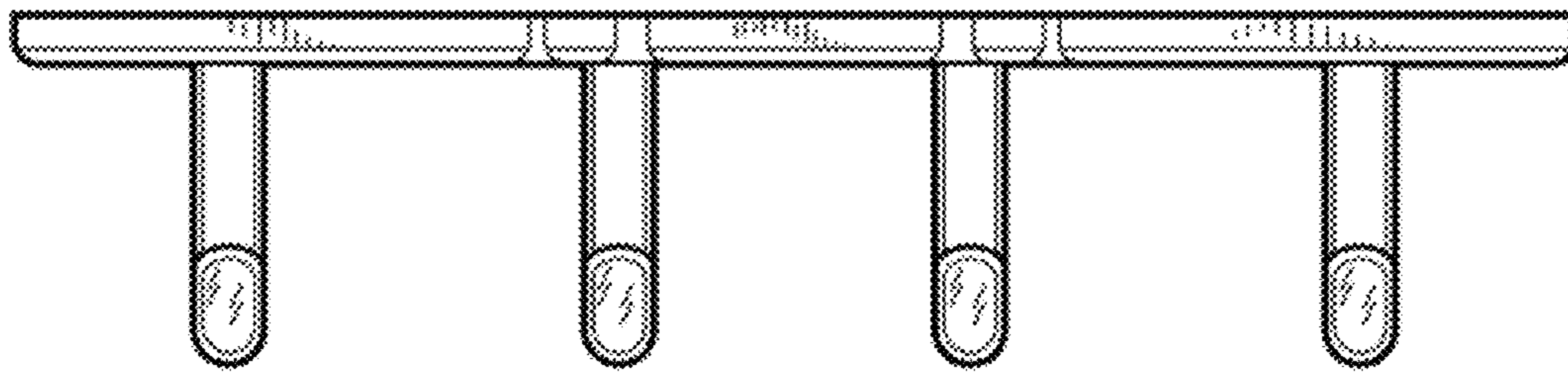

Fig. 3

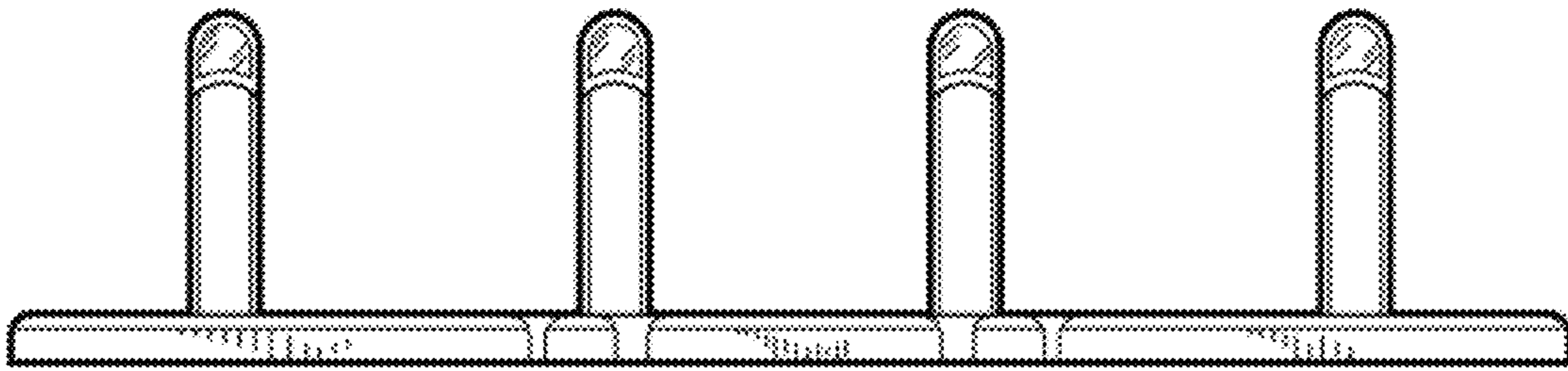

Fig. 4

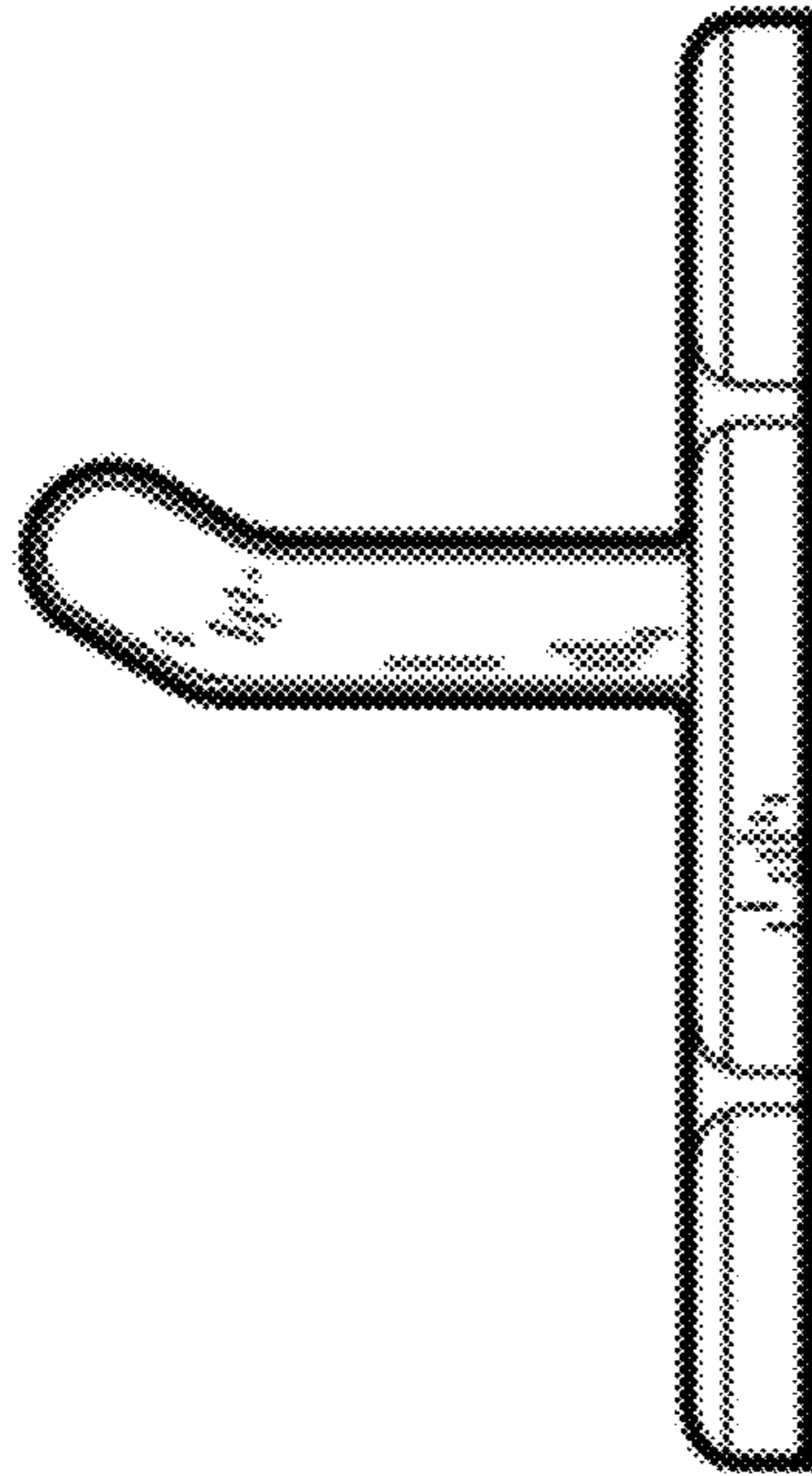

Fig. 5

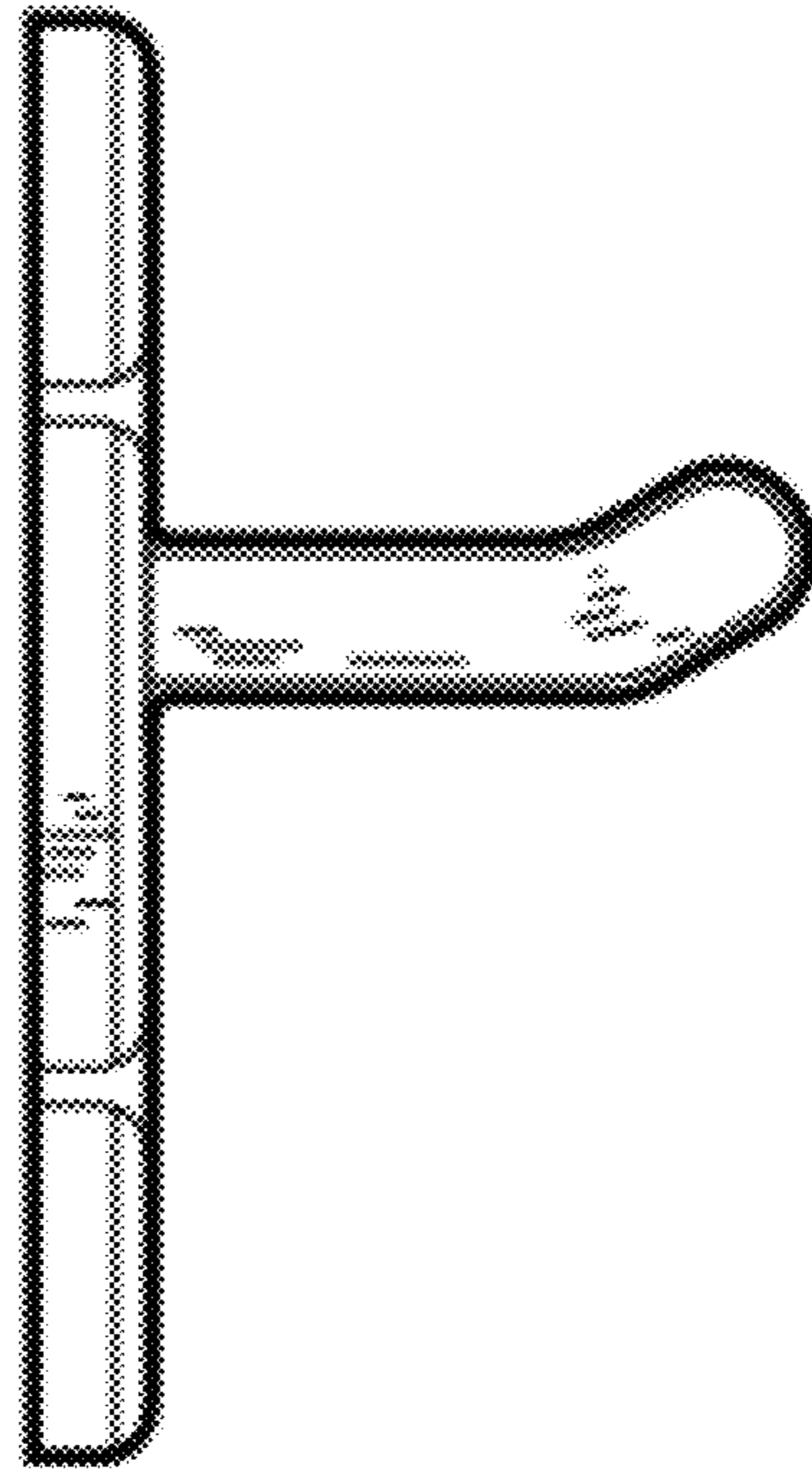

Fig. 6

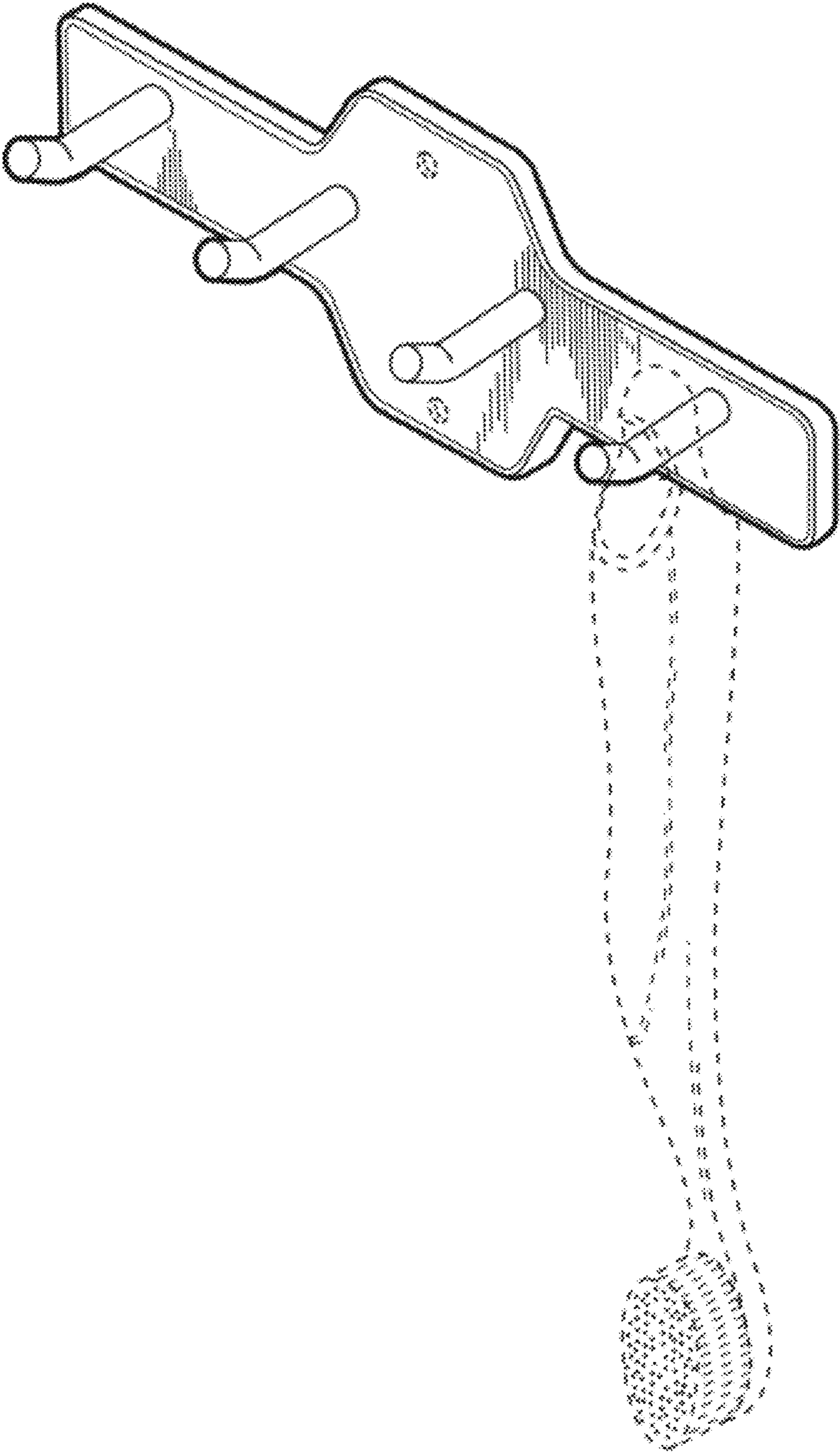

Fig. 7

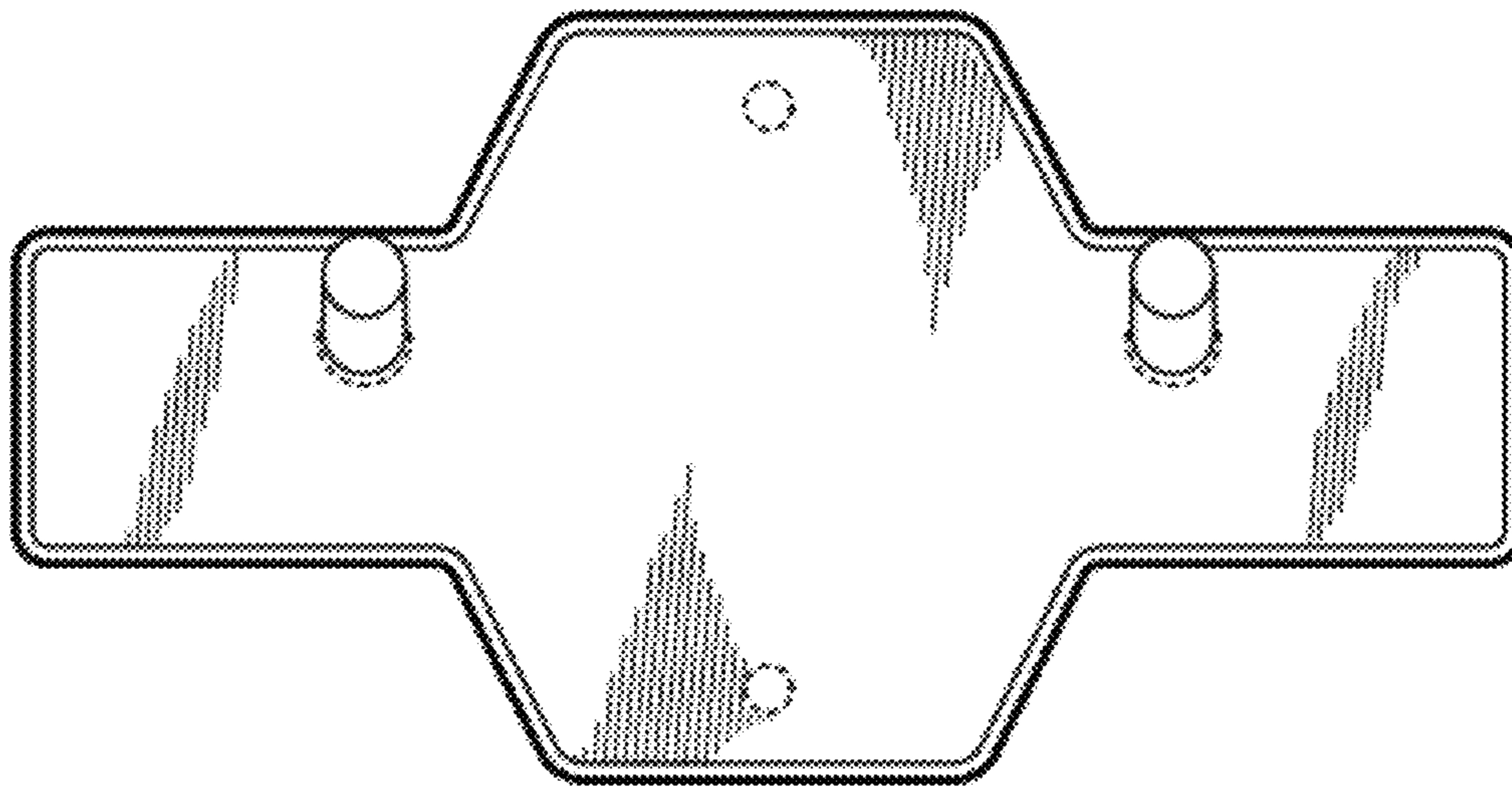

Fig. 8

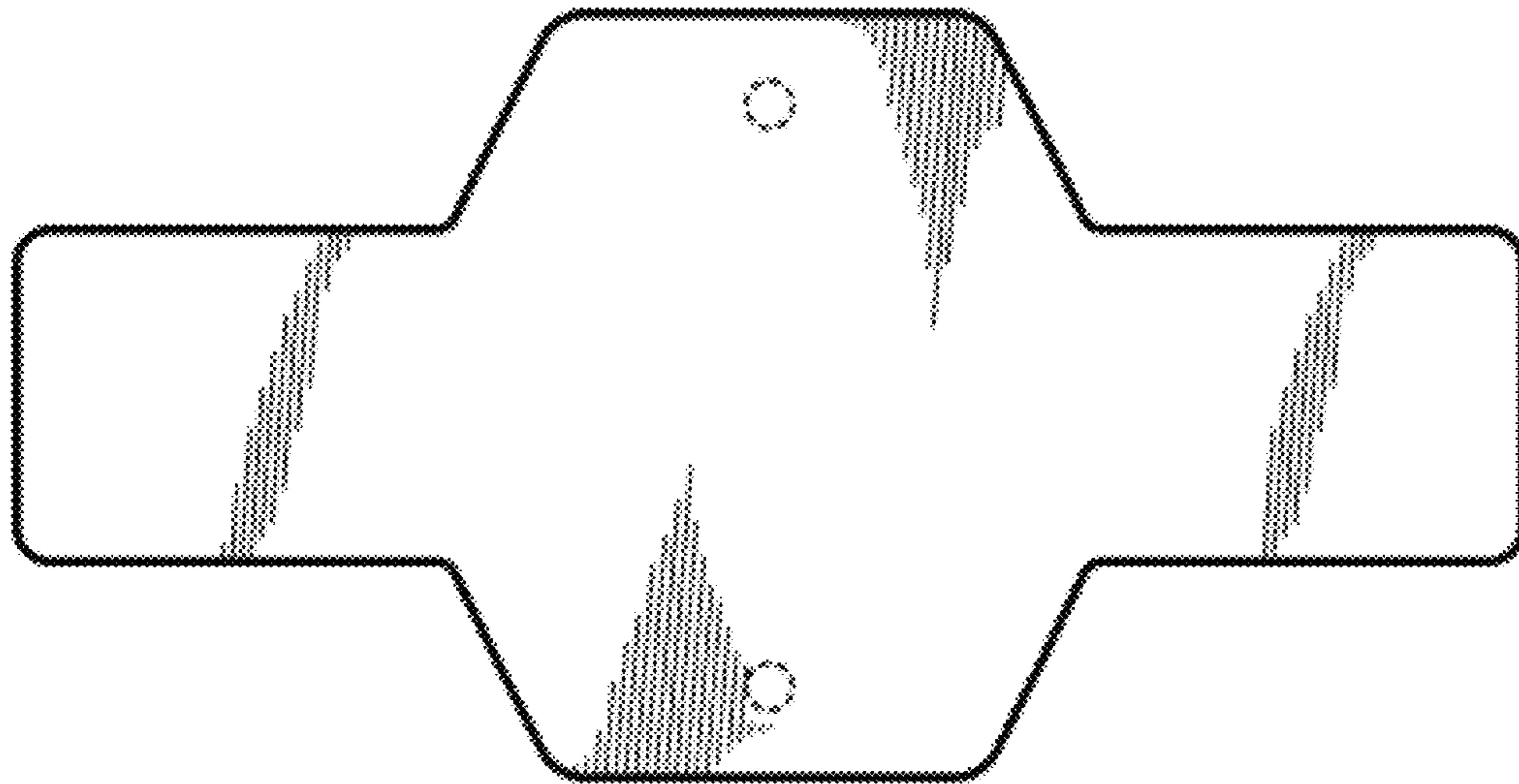

Fig. 9

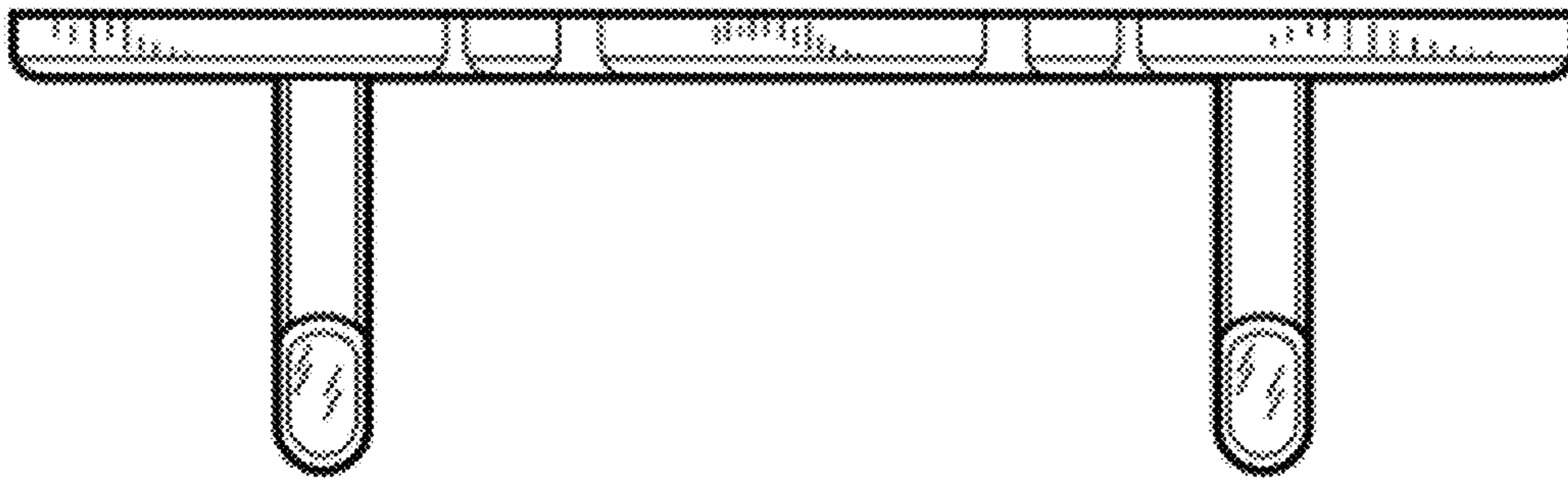

Fig. 10

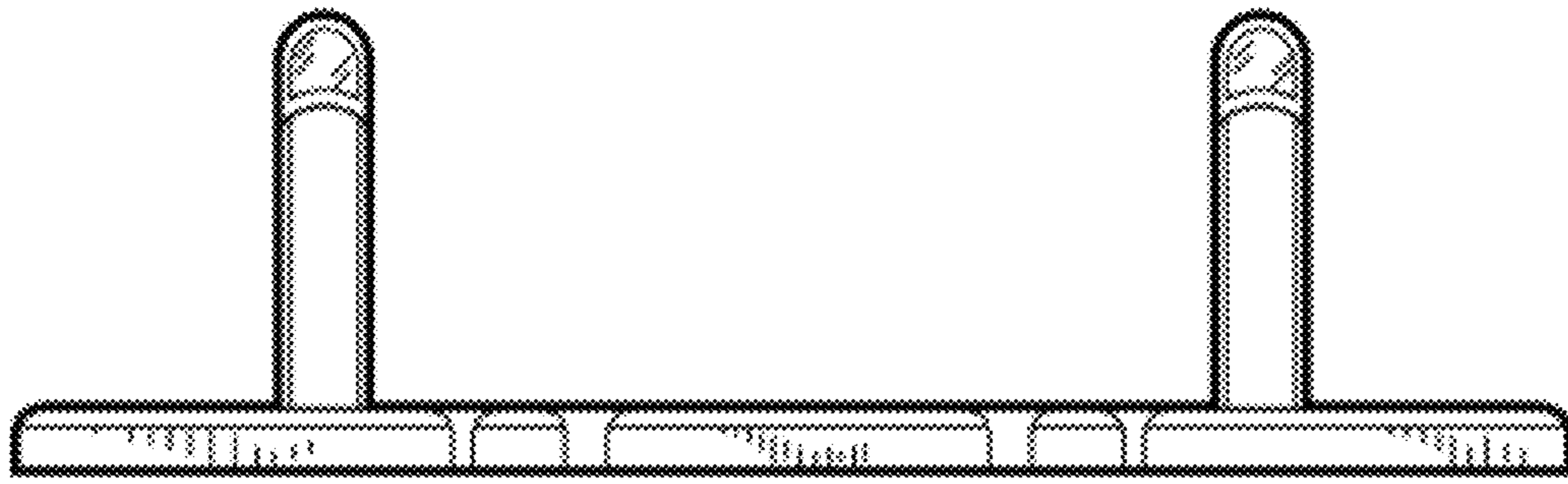

Fig. 11

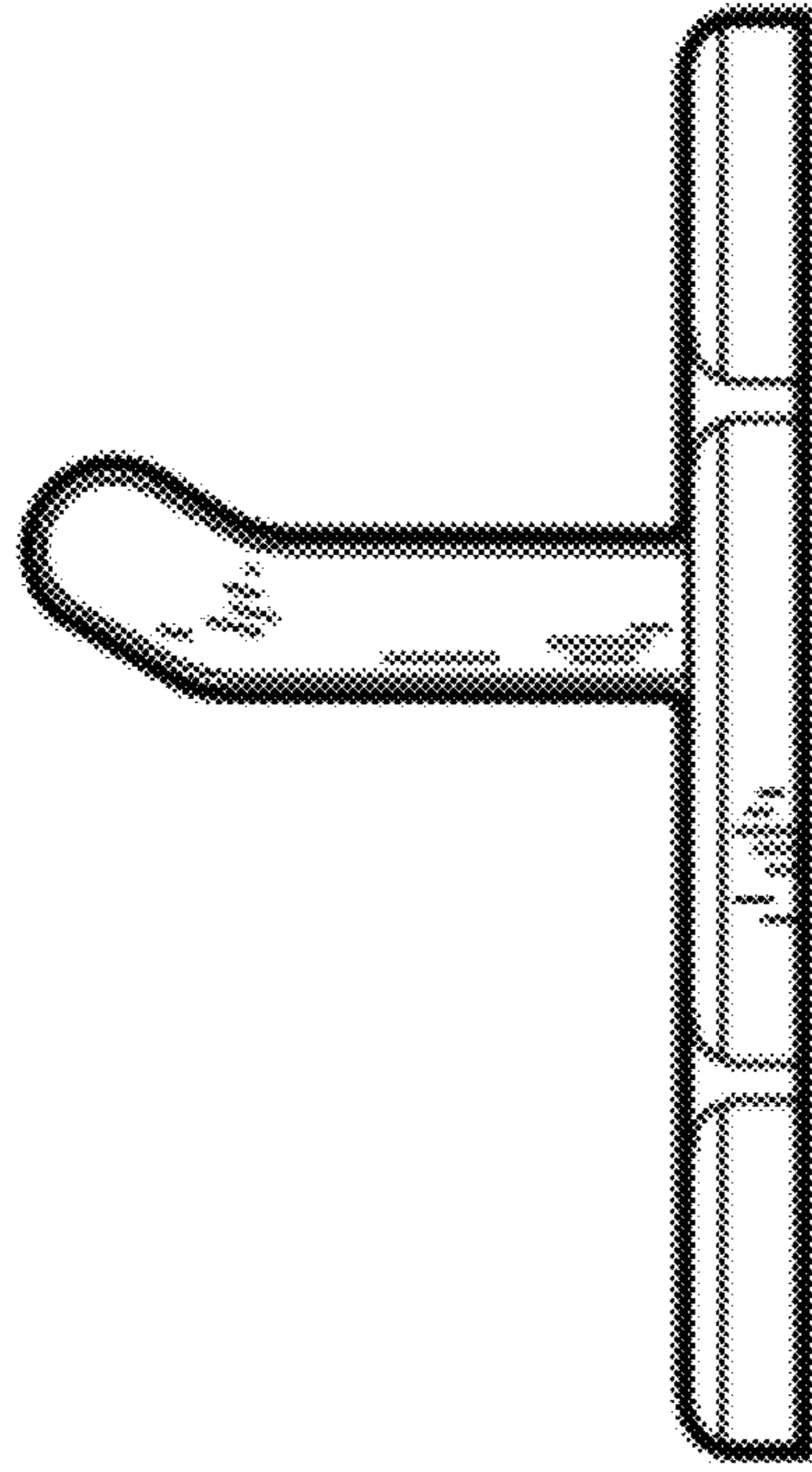

Fig. 12

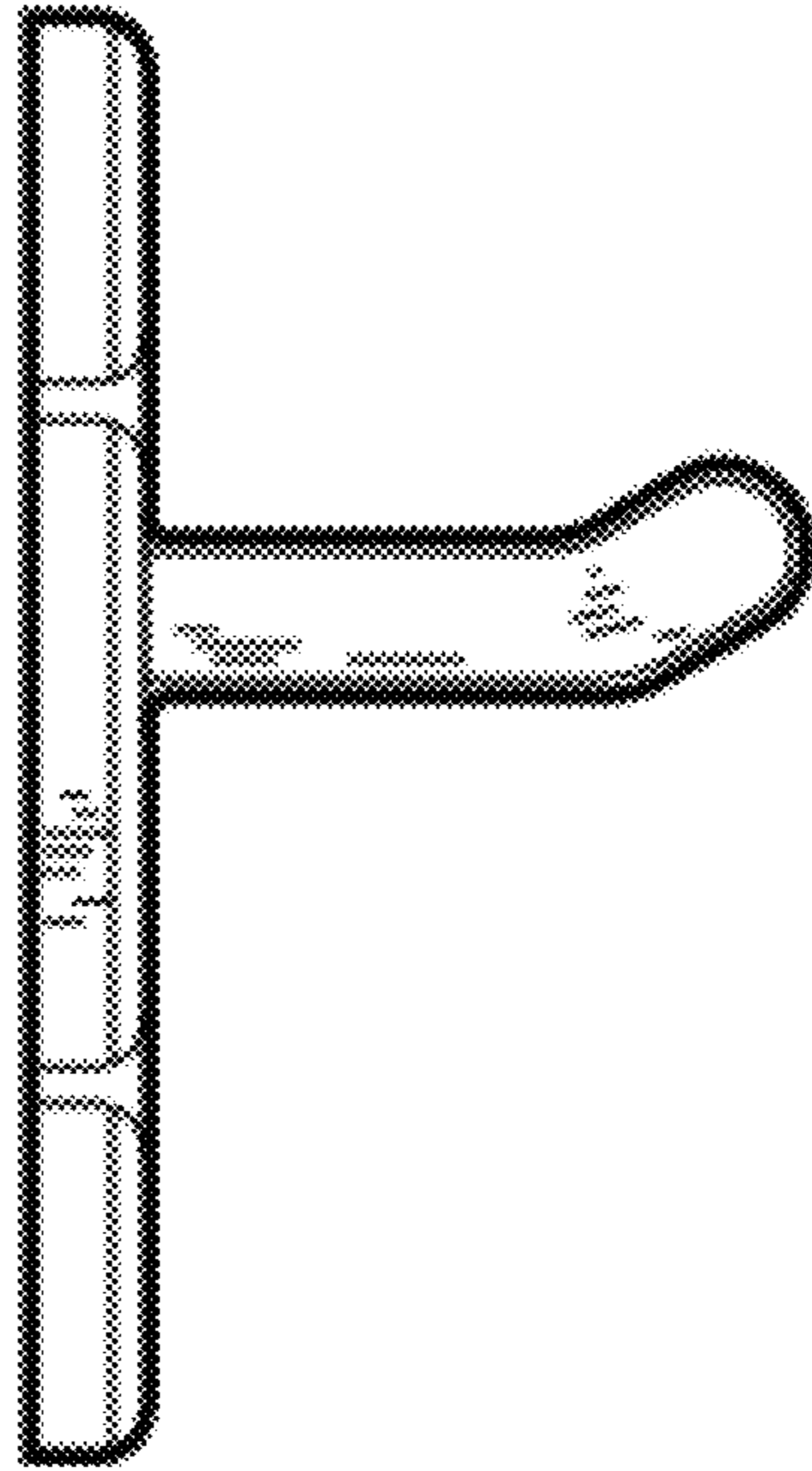

Fig. 13

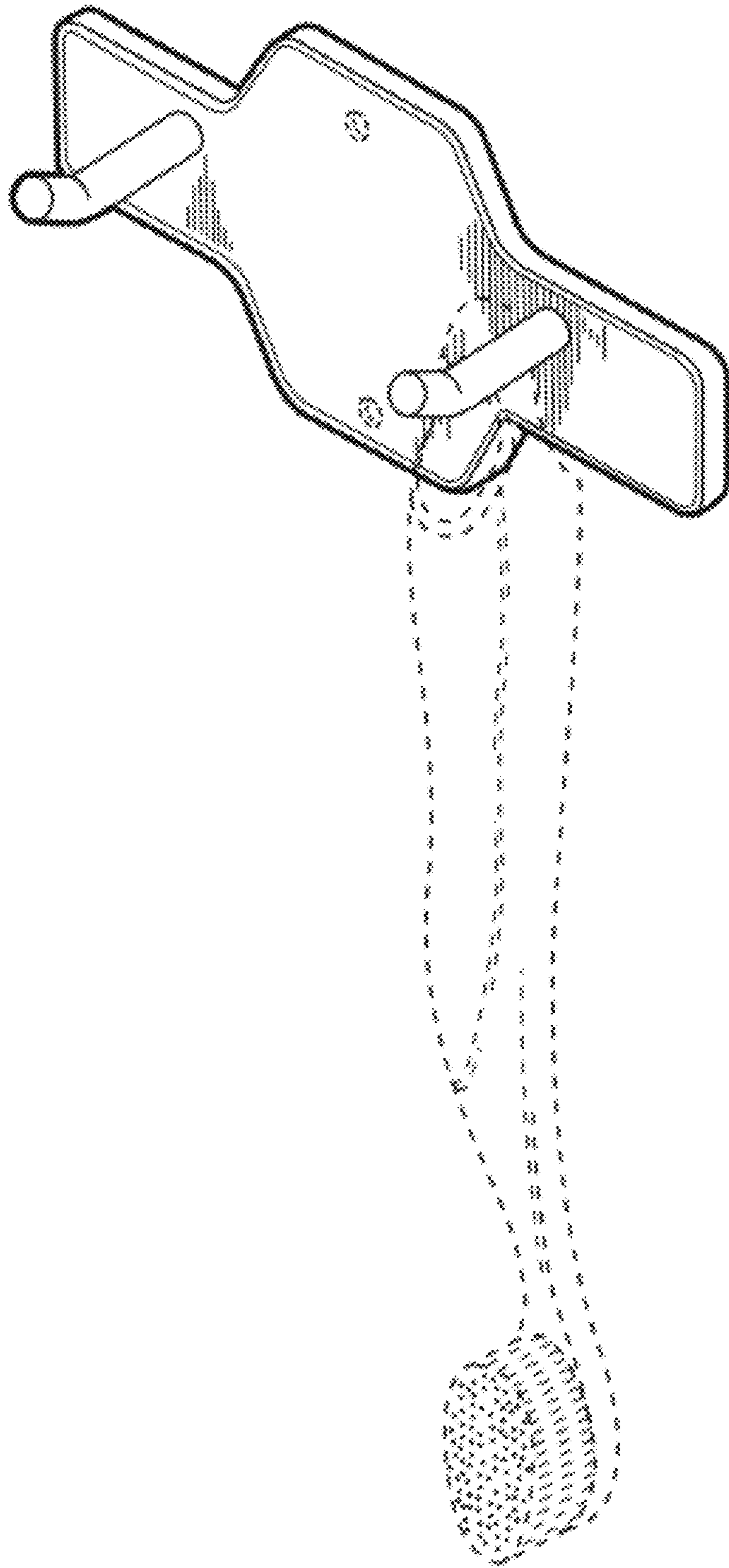

Fig. 14