



US00D668010S

(12) **United States Design Patent**
Stickney et al.

(10) **Patent No.:** **US D668,010 S**

(45) **Date of Patent:** **** Sep. 25, 2012**

(54) **VACUUM CLEANER**

(75) Inventors: **Timothy Nicholas Stickney**,
Malmesbury (GB); **Peter David**
Gammack, Malmesbury (GB); **James**
Dyson, Malmesbury (GB)

(73) Assignee: **Dyson Limited**, Malmesbury, Wiltshire
(GB)

(**) Term: **14 Years**

(21) Appl. No.: **29/385,064**

(22) Filed: **Feb. 8, 2011**

(30) **Foreign Application Priority Data**

Aug. 27, 2010 (ER) 001231708-0001

(51) **LOC (9) Cl.** **15-05**

(52) **U.S. Cl.** **D32/18**

(58) **Field of Classification Search** D32/31,
D32/34, 22, 18, 21; 15/347, 353, 320, 329,
15/344; 55/320, 337, DIG. 3, 429, 345, 459.1
See application file for complete search history.

(56) **References Cited**

U.S. PATENT DOCUMENTS

D348,548 S * 7/1994 Pino D32/18
D577,163 S * 9/2008 Dyson et al. D32/21
D587,415 S * 2/2009 Dyson et al. D32/31

7,874,040 B2 * 1/2011 Follows et al. 15/347
D635,728 S * 4/2011 Fjellman D32/22
2009/0113663 A1 * 5/2009 Follows et al. 15/347
2010/0229321 A1 * 9/2010 Dyson et al. 15/344
2011/0219571 A1 * 9/2011 Dyson et al. 15/344

OTHER PUBLICATIONS

Stickney et al., U.S. Office Action mailed Feb. 8, 2012, directed to
U.S. Appl. No. 29/384,862; 8 pages.

Stickney et al., U.S. Office Action mailed Feb. 8, 2012, directed to
U.S. Appl. No. 29/384,857; 6 pages.

Stickney et al., U.S. Office Action mailed Feb. 9, 2012, directed to
U.S. Appl. No. 29/384,858; 5 pages.

* cited by examiner

Primary Examiner — Ruth McInroy

(74) *Attorney, Agent, or Firm* — Morrison & Foerster LLP

(57) **CLAIM**

We claim the ornamental design for a vacuum cleaner, as
shown and described.

DESCRIPTION

FIG. 1 is a perspective view of a vacuum cleaner showing our
new design;

FIG. 2 is a plan view thereof from above;

FIG. 3 is a plan view thereof from below;

FIG. 4 is a side view thereof;

FIG. 5 is a side view from the side opposite that of FIG. 4;

FIG. 6 is a front view thereof; and,

FIG. 7 is a rear view thereof.

1 Claim, 6 Drawing Sheets

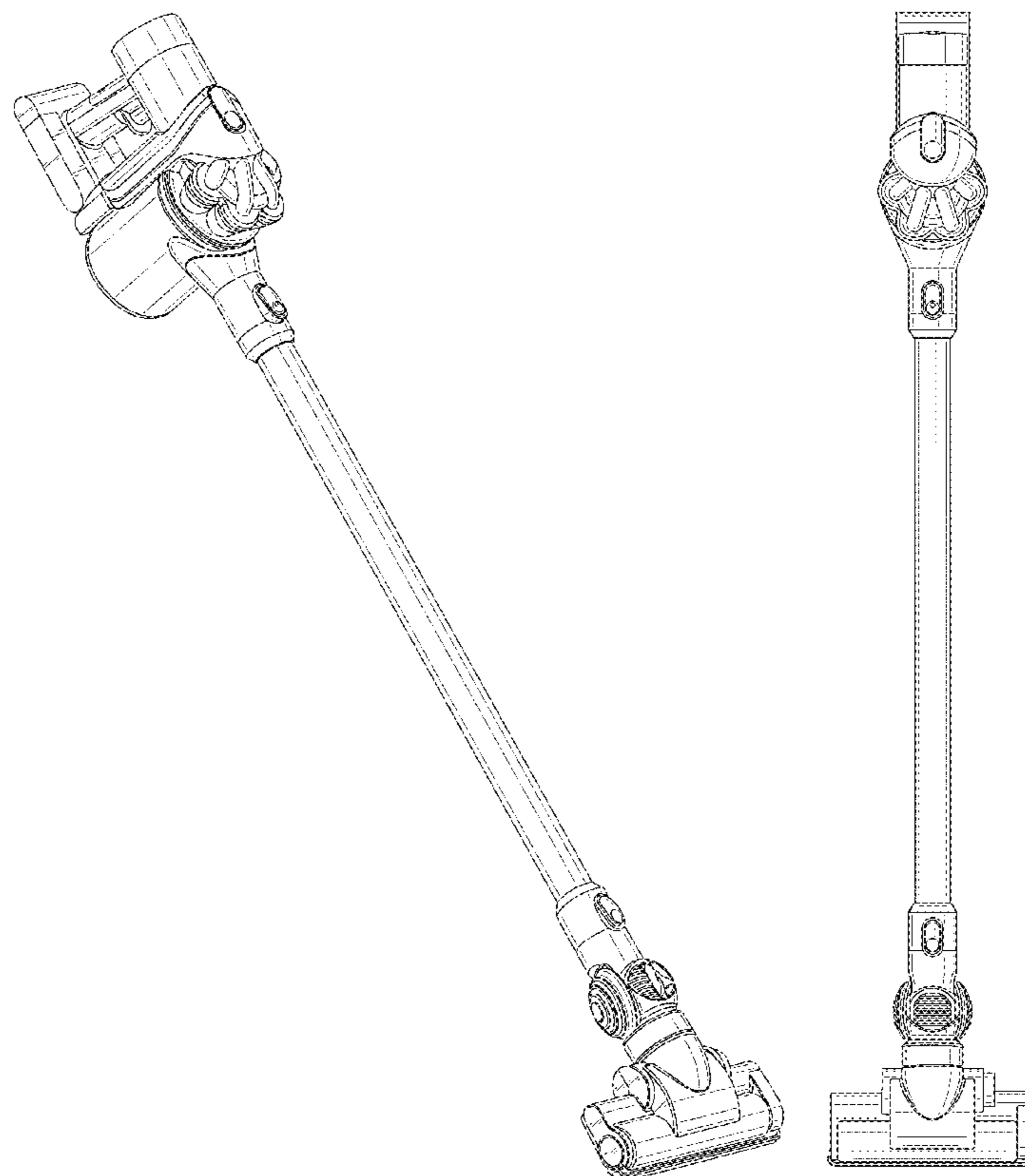

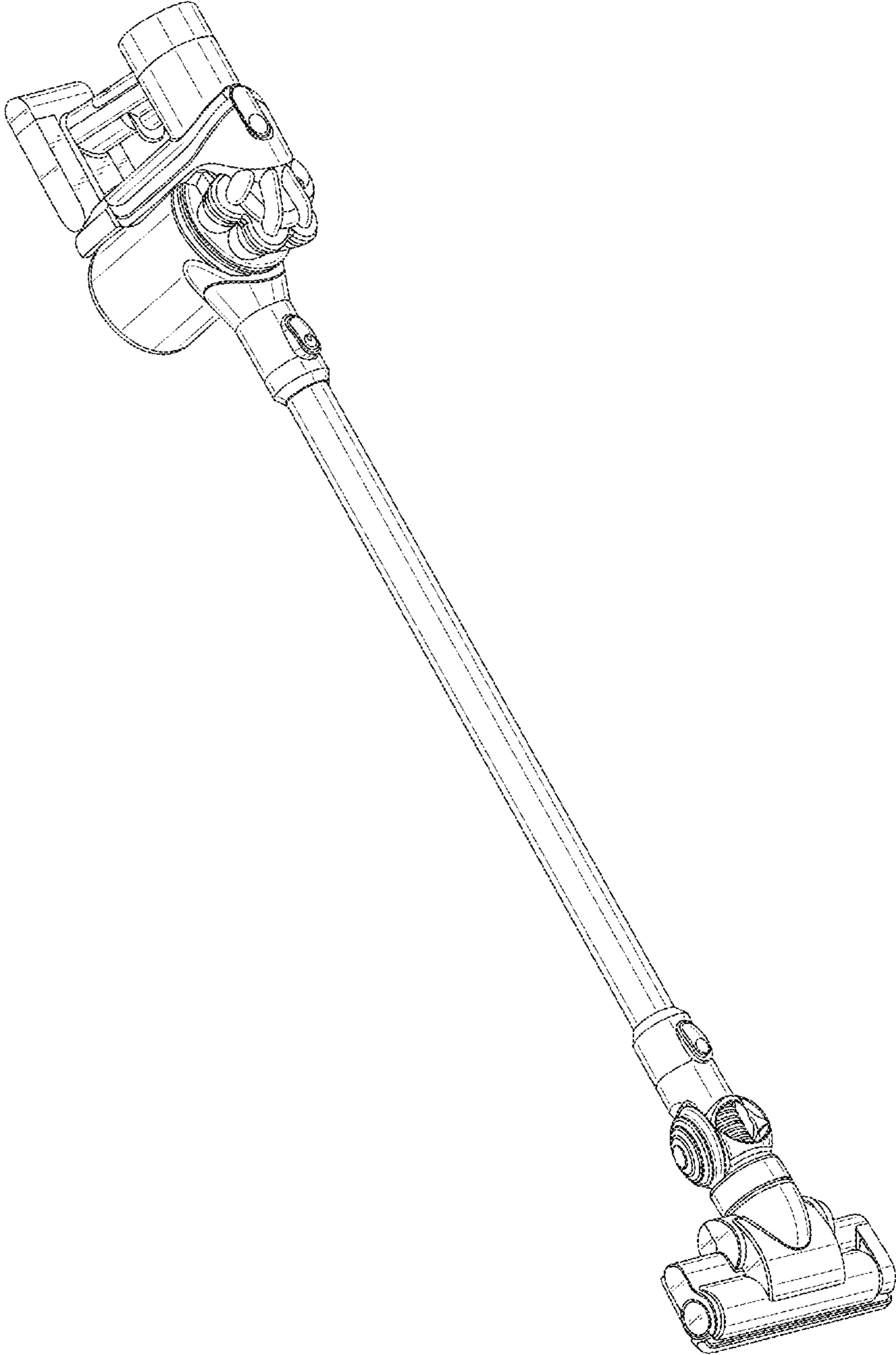

FIG. 1

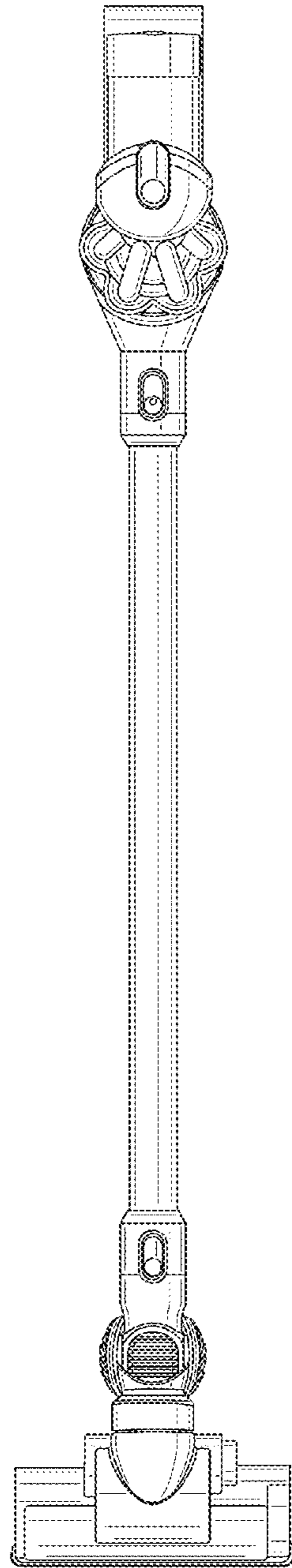

FIG. 2

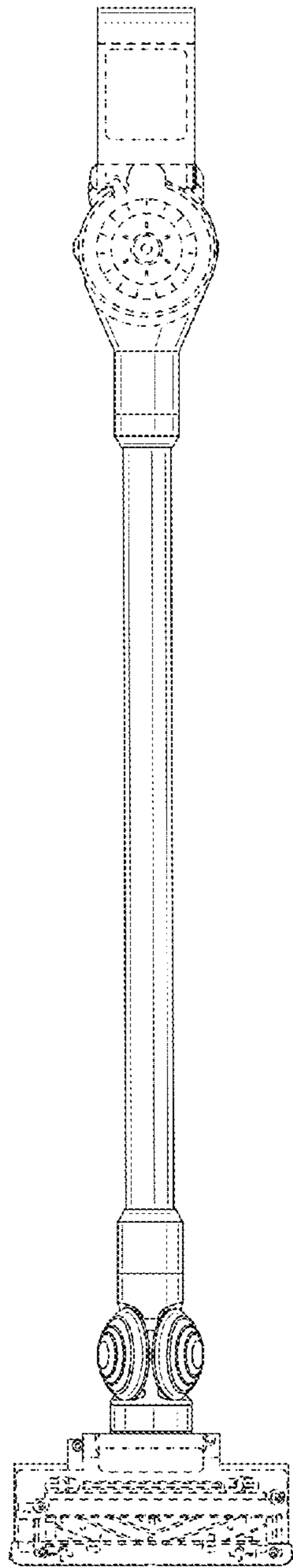

FIG. 3

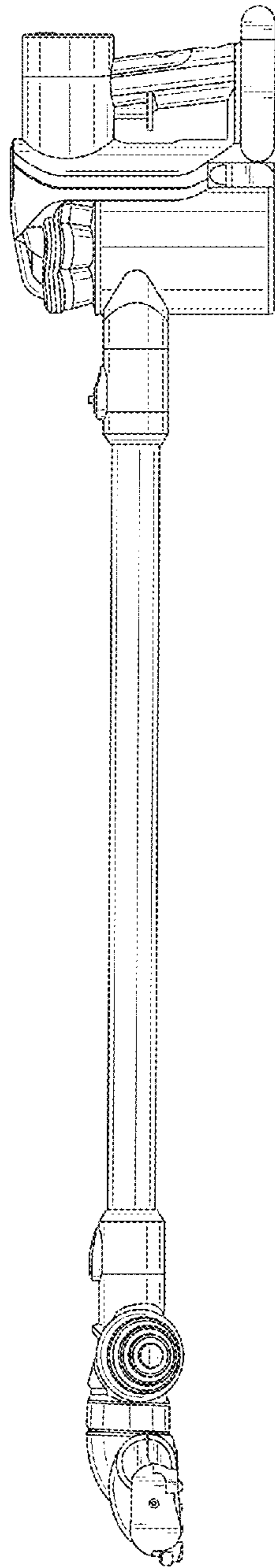

FIG. 4

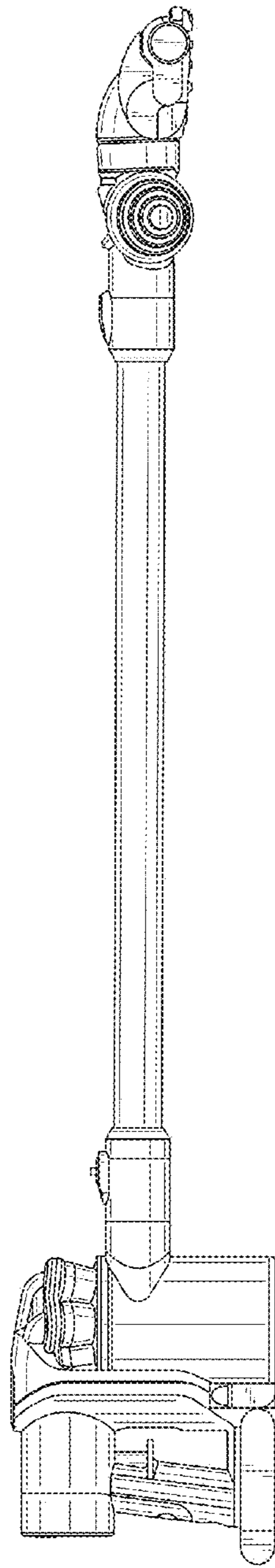

FIG. 5

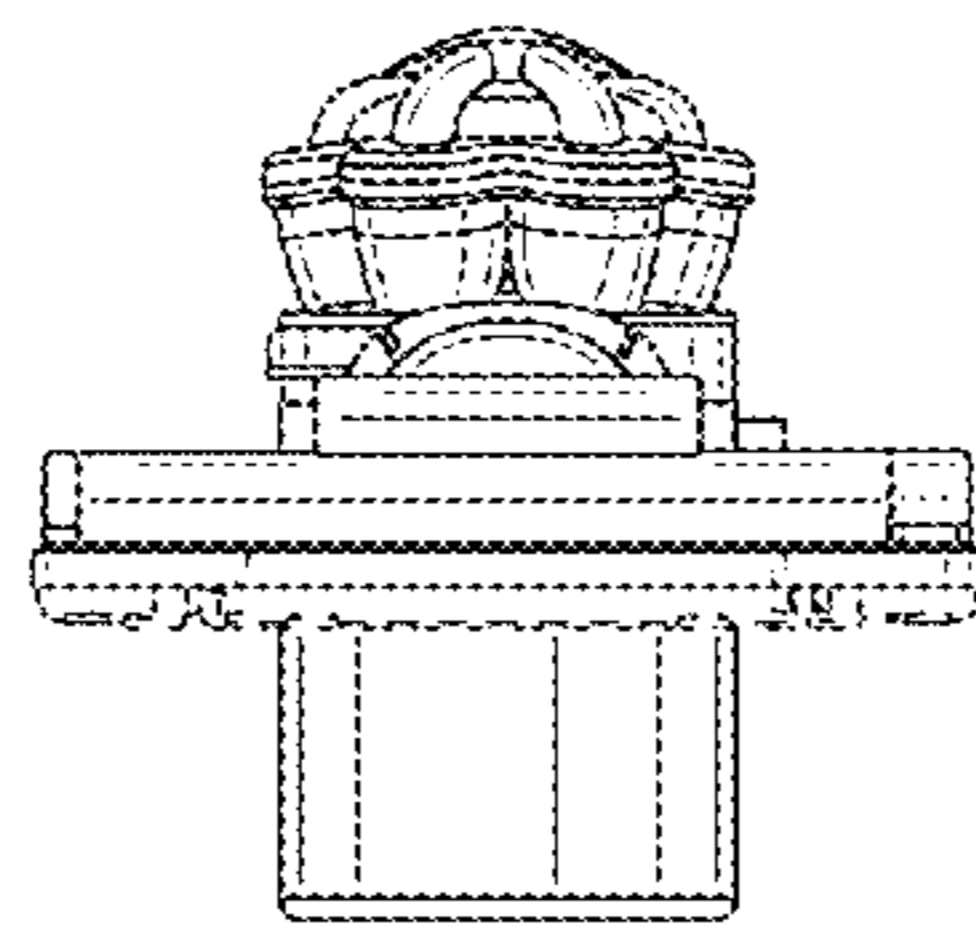

FIG. 6

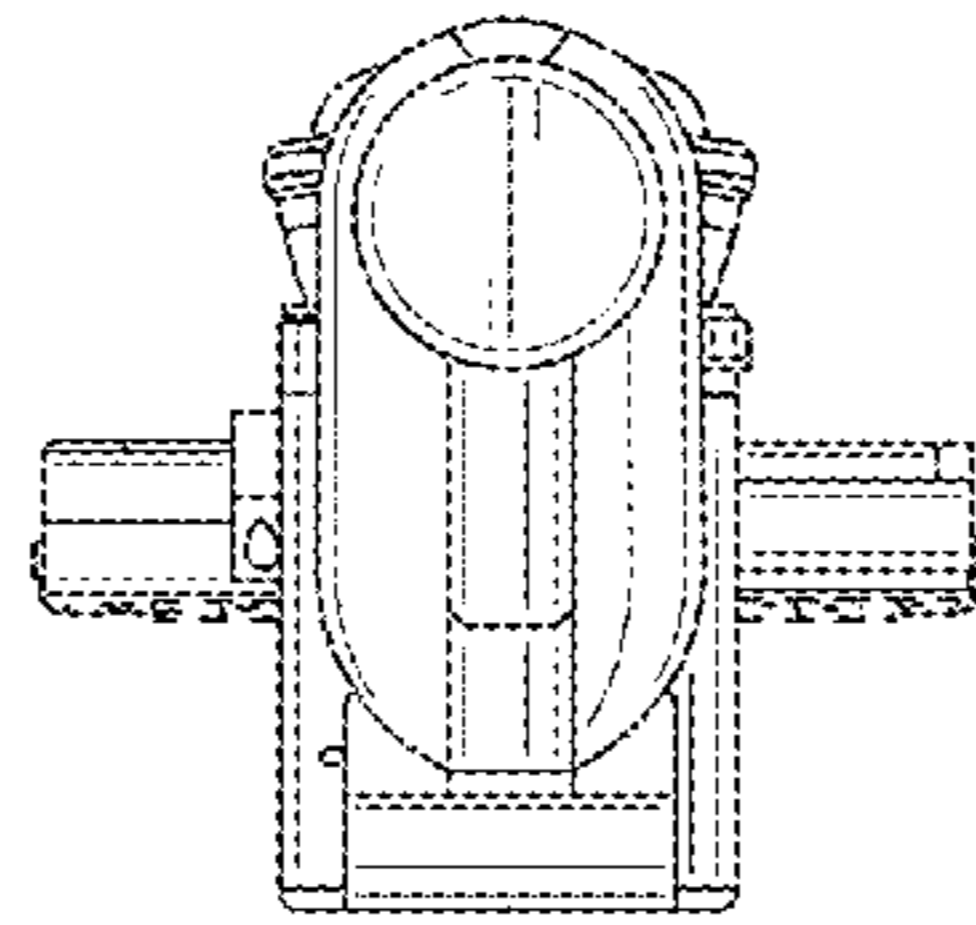

FIG. 7

UNITED STATES PATENT AND TRADEMARK OFFICE
CERTIFICATE OF CORRECTION

PATENT NO. : D668,010 S
APPLICATION NO. : 29/385064
DATED : September 25, 2012
INVENTOR(S) : Gammack et al.

Page 1 of 1

It is certified that error appears in the above-identified patent and that said Letters Patent is hereby corrected as shown below:

On the title page, item (12), delete “Stickney et al.” and insert --Gammack et al.--

On the title page, item (75), the following inventor information should be deleted:

“Timothy Nicholas Stickney, Malmesbury (GB)”

Signed and Sealed this
Eighth Day of November, 2016



Michelle K. Lee
Director of the United States Patent and Trademark Office