



US00D668001S

(12) **United States Design Patent**  
**Juhlin et al.**

(10) **Patent No.:** **US D668,001 S**  
(45) **Date of Patent:** **\*\* Sep. 25, 2012**

(54) **FRONT OPENING FRAME OF A WELDING HELMET**

(75) Inventors: **Oskar Juhlin**, Gustavsberg (SE);  
**Martin Birath**, Lidingö (SE); **Björn Daniels**, Vikarbyn (SE)

(73) Assignee: **3M Innovative Properties Company**,  
St. Paul, MN (US)

(\*\*) Term: **14 Years**

(21) Appl. No.: **29/368,910**

(22) Filed: **Aug. 31, 2010**

(30) **Foreign Application Priority Data**

Mar. 10, 2010 (EM) ..... 001200919

(51) **LOC (9) Cl.** ..... **29-02**

(52) **U.S. Cl.** ..... **D29/122**

(58) **Field of Classification Search** ..... D29/100,  
D29/102, 104, 105, 106, 107, 108, 109, 110,  
D29/111, 122; D2/878, 879, 882; D24/110.1,  
D24/110.2, 110.3; 2/455, 410, 8.1, 8.2, 8.3,  
2/8.4, 8.7, 9, 422, 423, 424, 425, 15, 6.3,  
2/6.5, 6.7, 7, 206, 417, 418, 419, 171, 205,  
2/431, 432; 128/206.12, 206.13, 206.28,  
128/206.24, 857

See application file for complete search history.

(56) **References Cited**

U.S. PATENT DOCUMENTS

3,594,816 A \* 7/1971 Webb et al. .... 2/10  
D250,067 S 10/1978 Land, Jr.  
4,495,657 A \* 1/1985 Bay ..... 2/10  
D297,179 S 8/1988 Seehaus et al.  
5,131,101 A \* 7/1992 Chin ..... 2/424  
D331,129 S 11/1992 Heinrich  
D356,188 S 3/1995 Kittelsen  
D365,666 S 12/1995 Gump  
5,970,514 A \* 10/1999 Wang-Lee ..... 2/9  
D418,255 S 12/1999 Hohdorf

D420,468 S 2/2000 Egger  
6,038,705 A \* 3/2000 Jarvis ..... 2/424  
D445,546 S 7/2001 Gafforio  
D475,815 S 6/2003 Kalhok  
D492,820 S 7/2004 Fournier  
D497,223 S 10/2004 Kalhok  
D517,744 S 3/2006 Lee  
D524,992 S \* 7/2006 Belin et al. .... D29/122  
D526,097 S \* 8/2006 Lilenthal et al. .... D29/122  
D526,745 S 8/2006 Hohdorf  
D532,163 S 11/2006 Curran  
D539,988 S \* 4/2007 Crafoord et al. .... D29/122

(Continued)

FOREIGN PATENT DOCUMENTS

CA 125936 1/2009

(Continued)

OTHER PUBLICATIONS

Juhlin, et al., 3M Speedglas 9100 iF International Forum Design GmbH, © 2009, Verlag, ISBN: 978-3-7643-8981-9.

(Continued)

*Primary Examiner* — Elizabeth J Oswecki

(57) **CLAIM**

The ornamental design for a front opening frame of a welding helmet, as shown and described.

**DESCRIPTION**

FIG. 1 is a perspective view of a front opening frame of a welding helmet showing our new design;  
FIG. 2 is a right side view thereof, the left side view being a mirror image thereof;  
FIG. 3 is a front view thereof;  
FIG. 4 is a rear view thereof;  
FIG. 5 is a top view thereof; and,  
FIG. 6 is a bottom view thereof.  
The broken lines shown in the drawings represent portions of the front opening frame of a welding helmet that form no part of the claimed design.

**1 Claim, 5 Drawing Sheets**

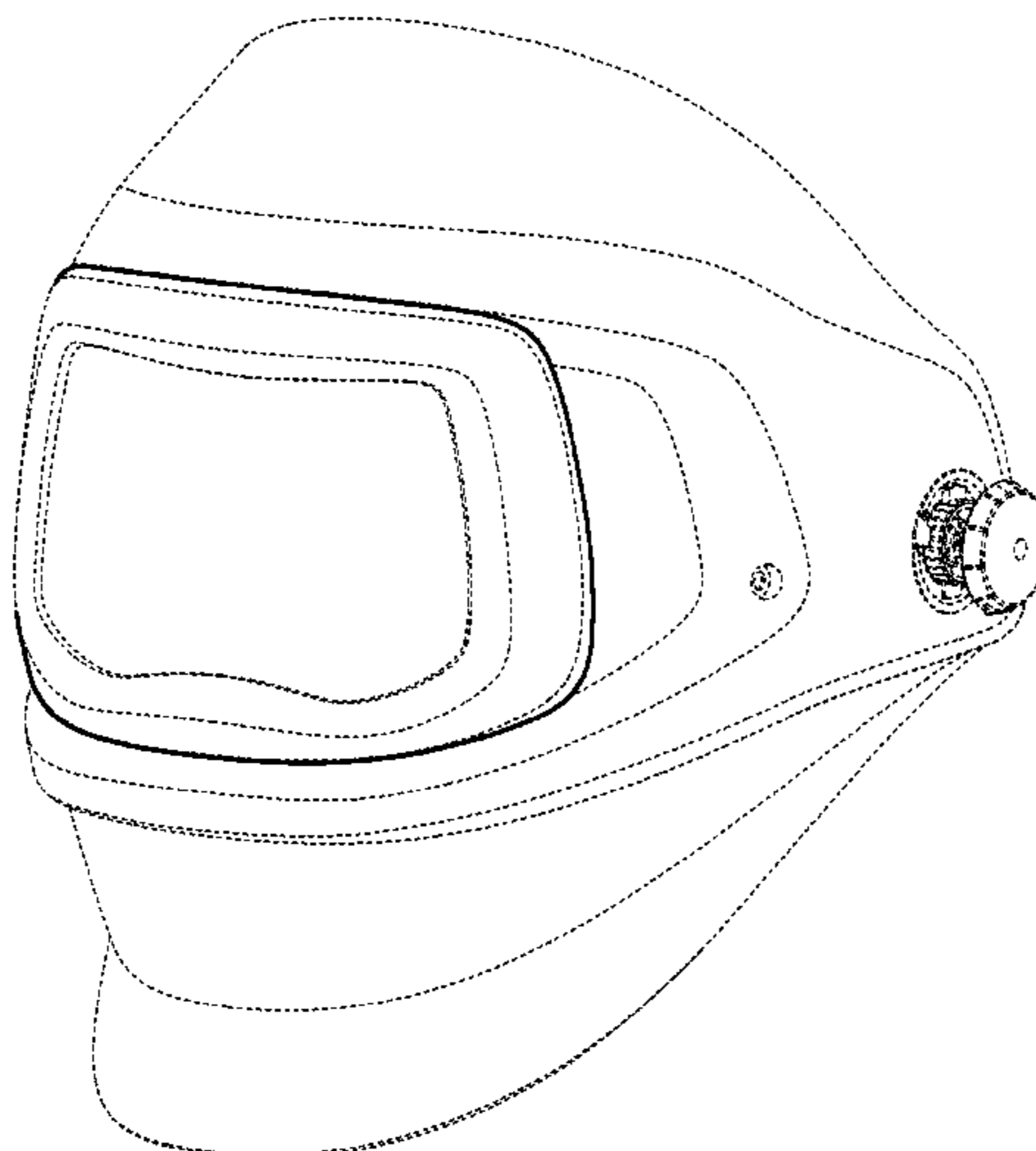

# US D668,001 S

Page 2

## U.S. PATENT DOCUMENTS

D565,800 S 4/2008 Wang  
D567,451 S 4/2008 Dion  
D574,558 S 8/2008 Morency  
D583,107 S 12/2008 Morency  
D584,003 S \* 12/2008 Juhlin ..... D29/110  
D584,005 S 12/2008 Morency  
D584,006 S 12/2008 Juhlin  
D584,007 S 12/2008 Juhlin  
D584,008 S 12/2008 Juhlin  
D584,009 S \* 12/2008 Juhlin ..... D29/122  
D585,160 S \* 1/2009 Juhlin ..... D29/122  
D590,547 S 4/2009 Brace  
D590,548 S 4/2009 Johnson  
D597,709 S \* 8/2009 Juhlin ..... D29/122  
D601,308 S 9/2009 Broersma  
D604,911 S \* 11/2009 Juhlin ..... D29/122  
D616,155 S \* 5/2010 Juhlin ..... D29/122

D617,956 S 6/2010 Taylor  
D631,614 S 1/2011 Renaud-Goud  
2006/0080761 A1\* 4/2006 Huh ..... 2/424

## FOREIGN PATENT DOCUMENTS

CA 125938 1/2009  
CA 125939 1/2009  
EM 0009754380001D 8/2008  
JP 1351393 1/2009  
KR 300528687D 5/2009

## OTHER PUBLICATIONS

3M Korea, 3M Speedglas, "Comfortable Protection for Safer Welding," Date unknown, however believed to be prior the filing of this application. Literature was cited in foreign counterpart Korean Application No. 30-2010-39963 in an Office Action dated Nov. 30, 2011.

\* cited by examiner

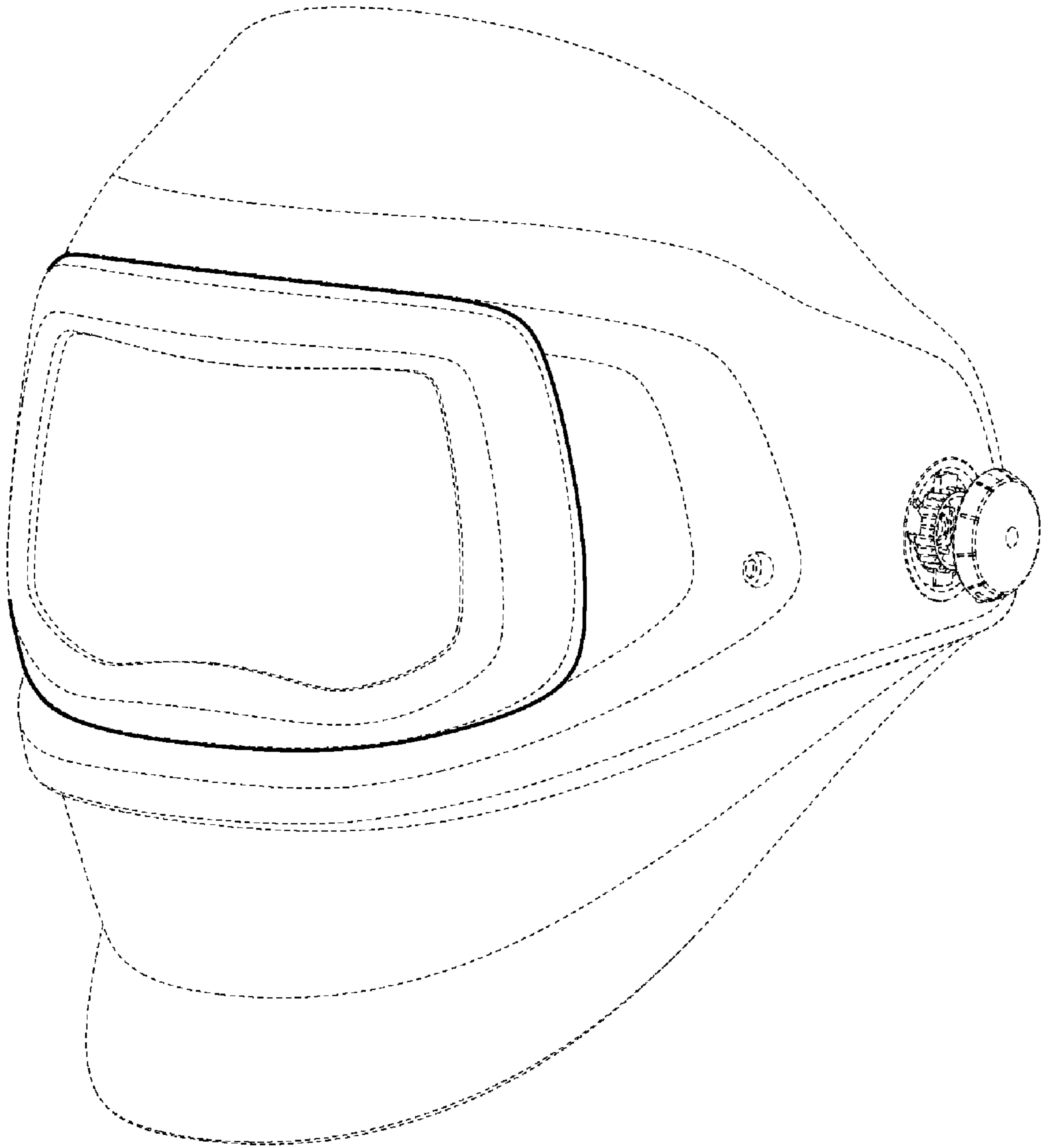

**FIG. 1**

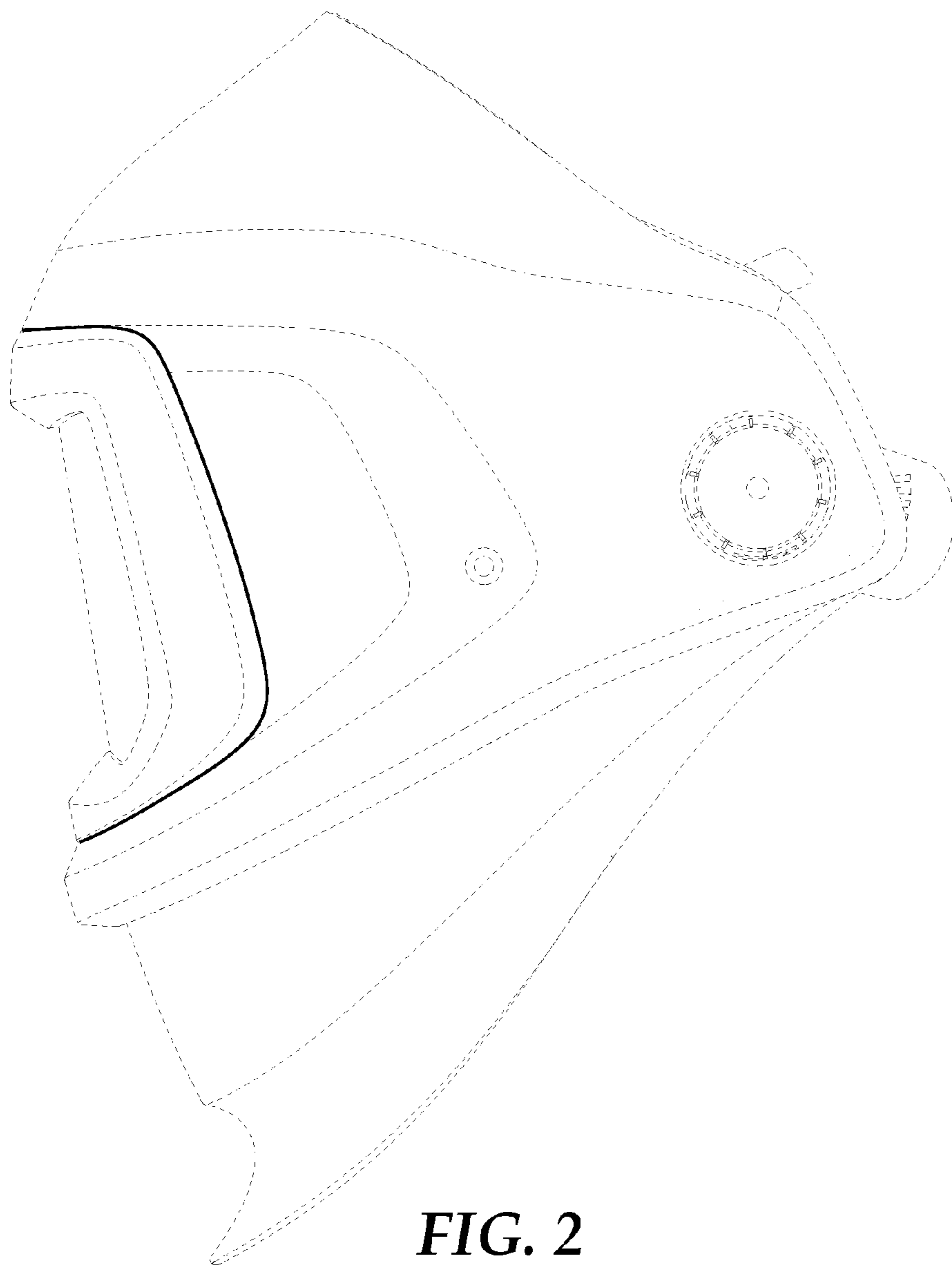

**FIG. 2**

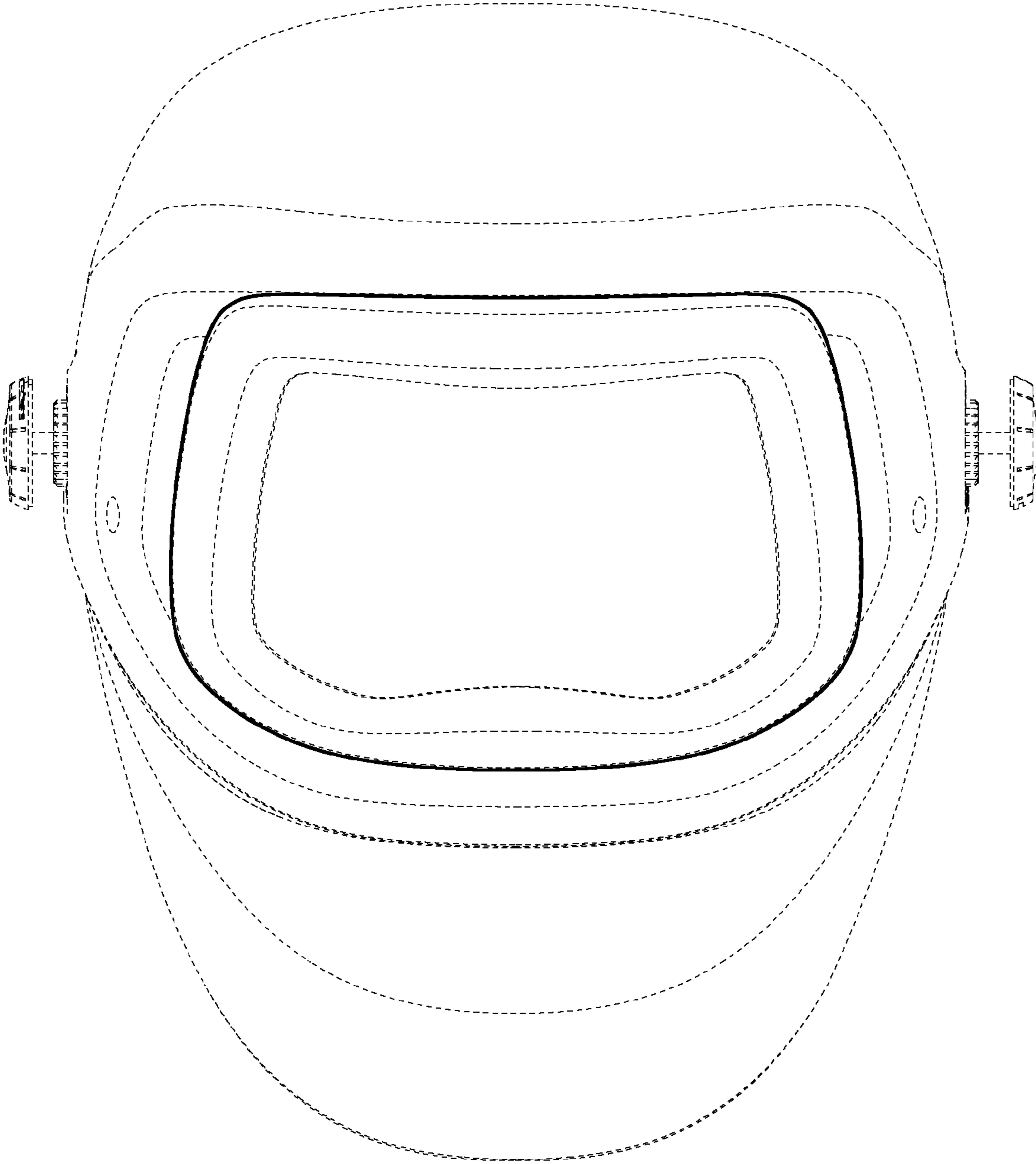

**FIG. 3**

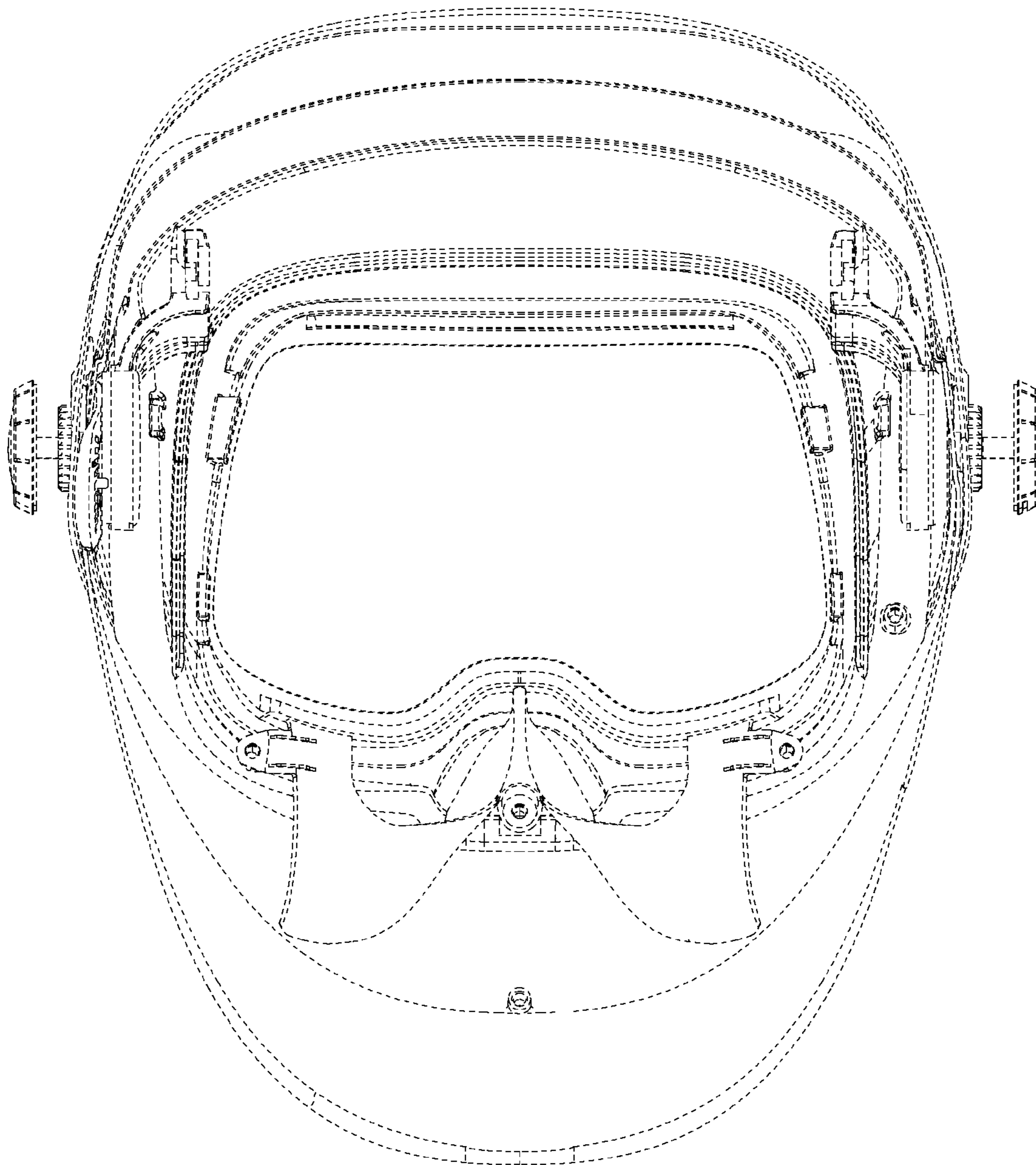

**FIG. 4**

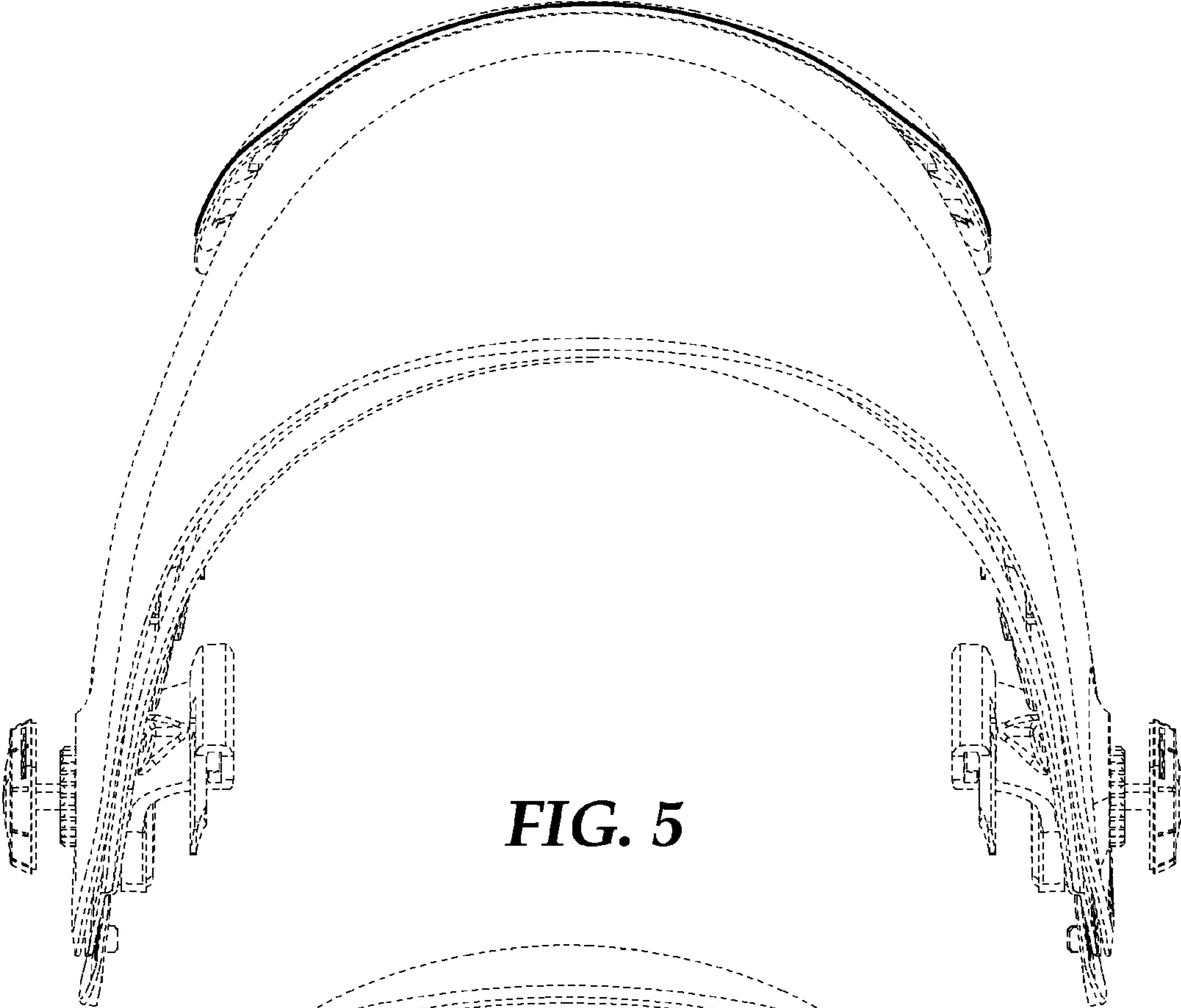

**FIG. 5**

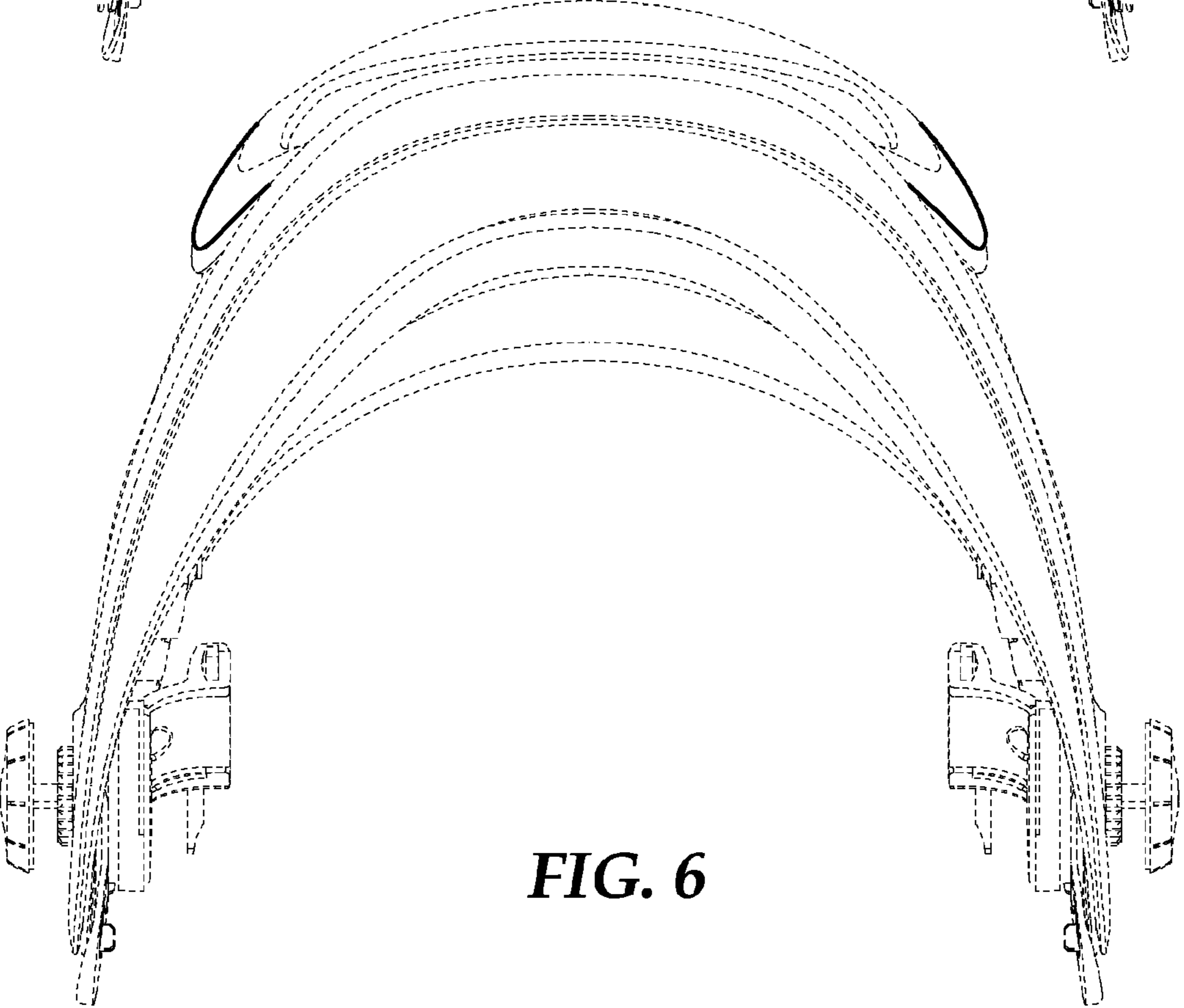

**FIG. 6**