



US00D667703S

(12) **United States Design Patent**  
**Ramirez**

(10) **Patent No.:** **US D667,703 S**

(45) **Date of Patent:** **\*\* Sep. 25, 2012**

(54) **FOOD PRESS**

(75) **Inventor:** **Giancarlo Ramirez**, Cincinnati, OH  
(US)

(73) **Assignee:** **Ramsco Diversified, Ltd.**, Cincinnati,  
OH (US)

(\*\*) **Term:** **14 Years**

(21) **Appl. No.:** **29/395,056**

(22) **Filed:** **Nov. 18, 2011**

(51) **LOC (9) Cl.** ..... **31-00**

(52) **U.S. Cl.** ..... **D7/665**

(58) **Field of Classification Search** ..... D7/665,  
D7/372, 381-386; 99/495, 501-511, 496,  
99/497; 366/64-67, 98, 142, 197-211, 241-254,  
366/279-292, 341-347; 241/100, 33, 36,  
241/37, 285.1-285.3, 168, 169, 282.1, 282.2,  
241/104, 110, 126, 213, 131-135, 92

See application file for complete search history.

(56) **References Cited**

**U.S. PATENT DOCUMENTS**

3,537,691 A \* 11/1970 Miyoshi et al. .... 241/282.2  
D255,005 S \* 5/1980 Fuchs ..... D7/665

D316,212 S \* 4/1991 Seal, Jr. .... D7/665  
D331,176 S \* 11/1992 Green ..... D7/679  
D339,502 S \* 9/1993 Kamiyama ..... D7/384  
D479,666 S \* 9/2003 Barker ..... D7/378  
6,666,574 B1 \* 12/2003 Pryor ..... 366/205  
8,109,668 B2 \* 2/2012 Garman et al. .... 366/205

\* cited by examiner

*Primary Examiner* — Terry Wallace

(74) *Attorney, Agent, or Firm* — Neal O. Willmann

(57) **CLAIM**

The ornamental design for the food press, as shown and described.

**DESCRIPTION**

FIG. 1 is a front side elevation view of a food press showing my new design;  
FIG. 2 is a left side elevation view thereof, the right side being a mirror image thereof;  
FIG. 3 is a back side elevation view thereof;  
FIG. 4 is the left side elevation view of FIG. 2 with the piston of said press elevated in the cylinder thereof;  
FIG. 5 is a top plan view thereof;  
FIG. 6 is a bottom plan view thereof; and,  
FIG. 7 is an elevated perspective view thereof.

**1 Claim, 4 Drawing Sheets**

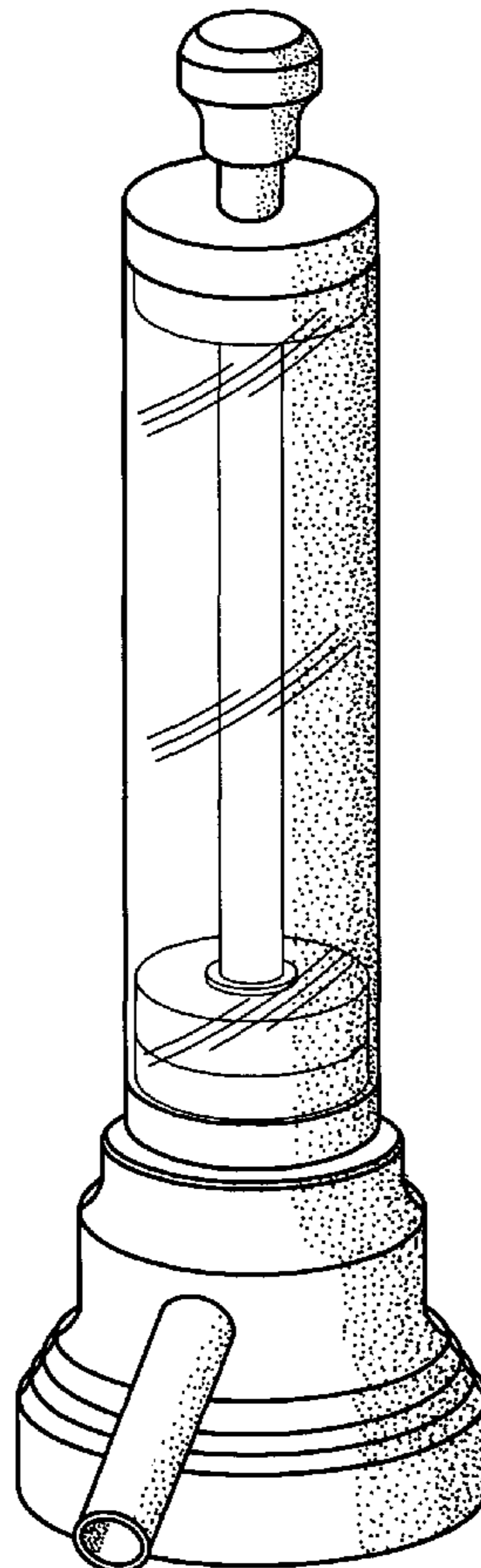

Fig. 1

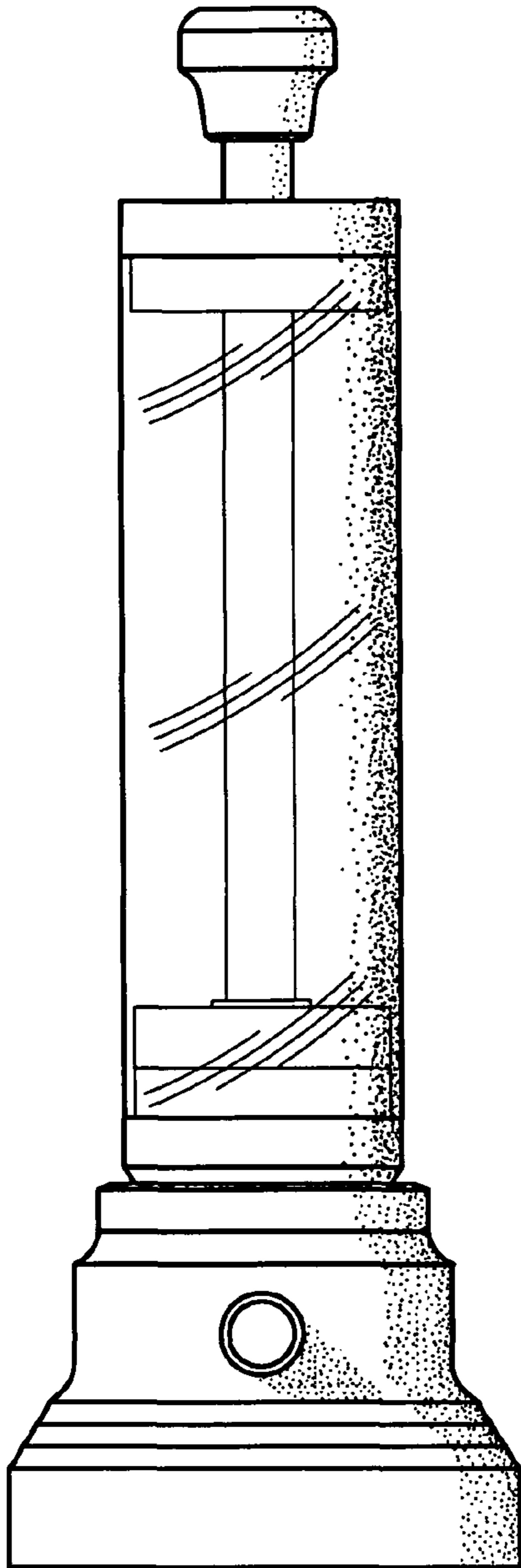

Fig. 2

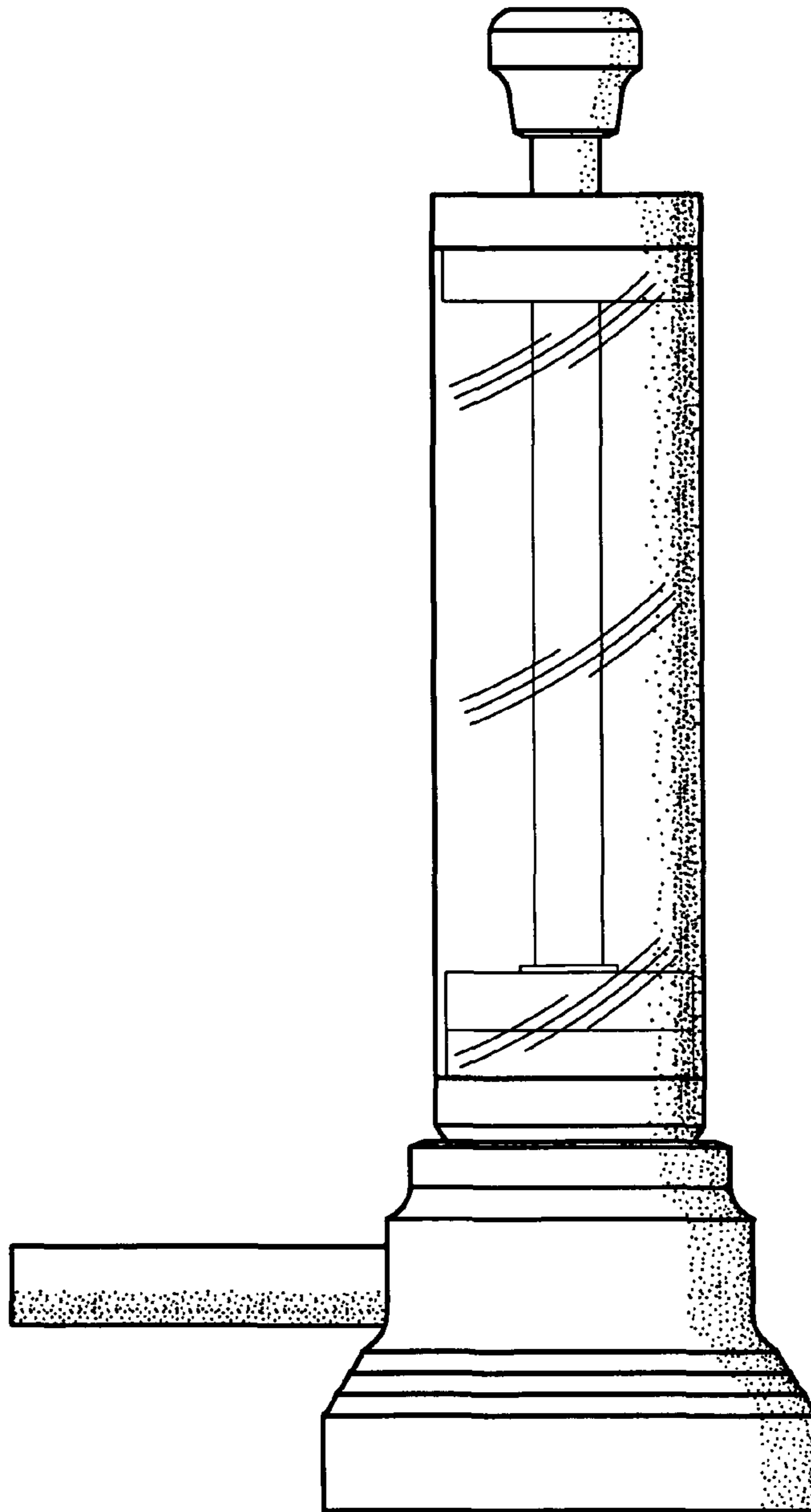

Fig. 3

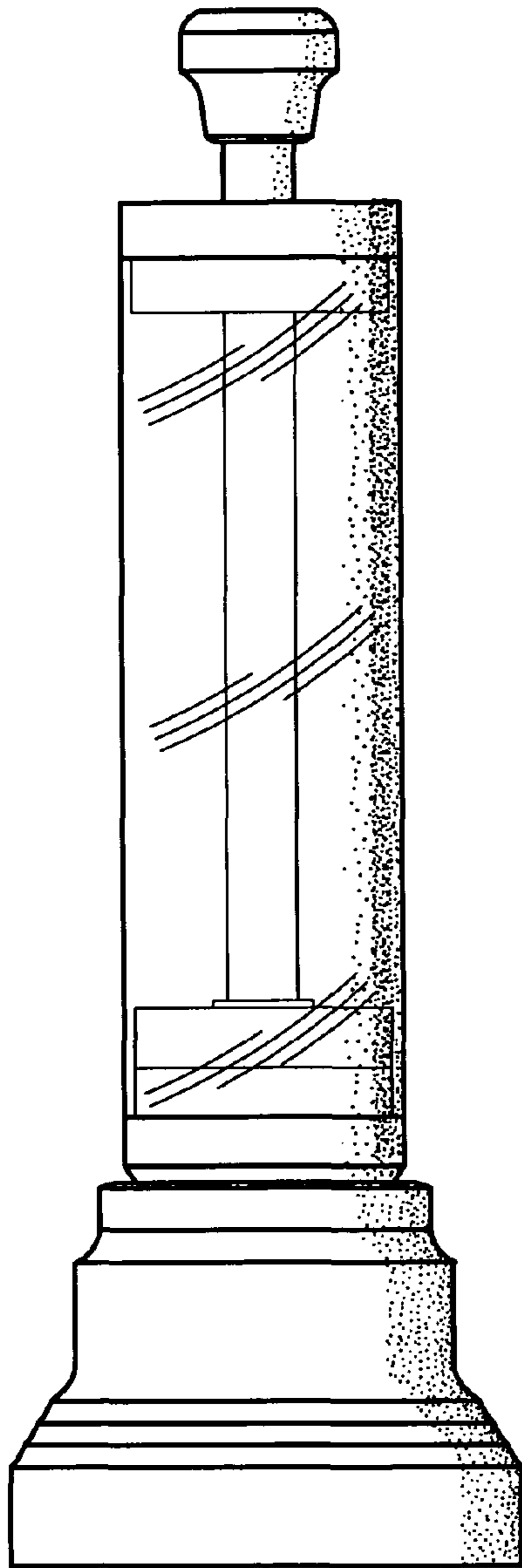

Fig. 4

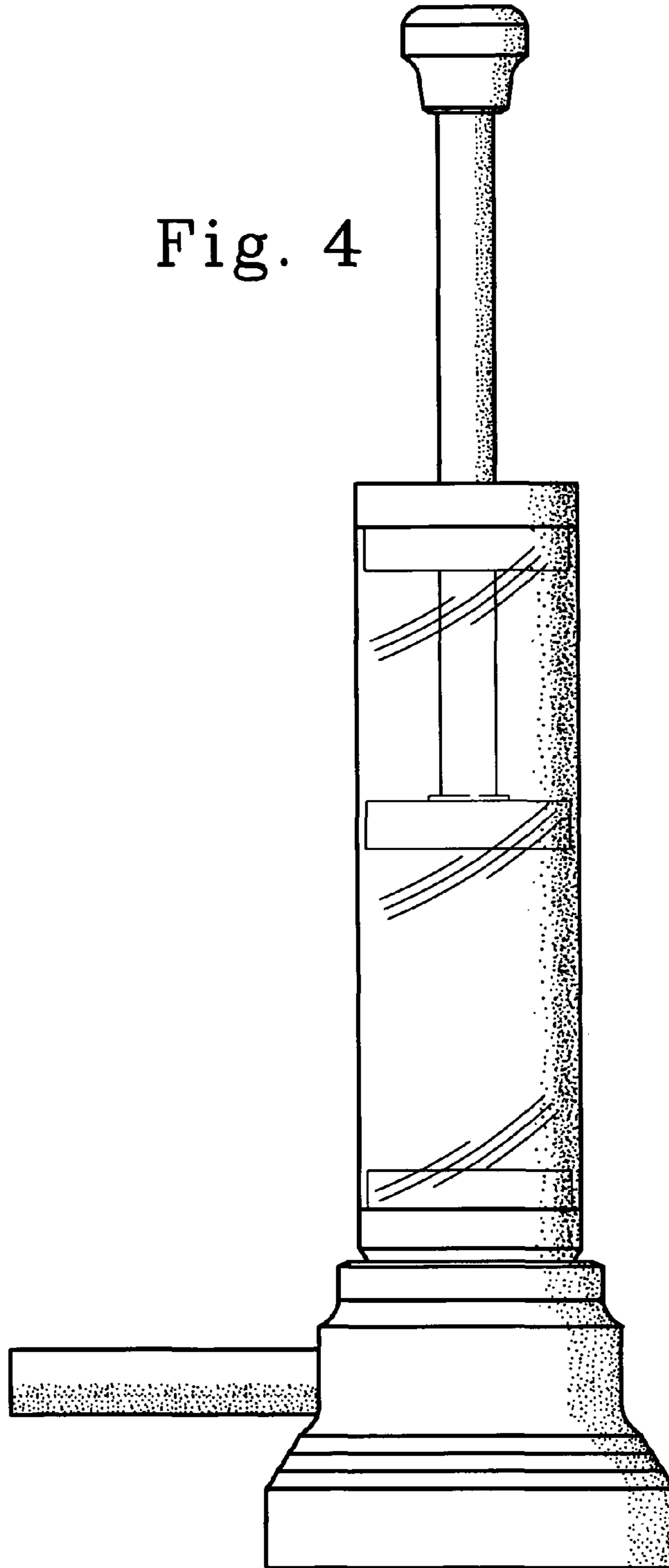

Fig. 5

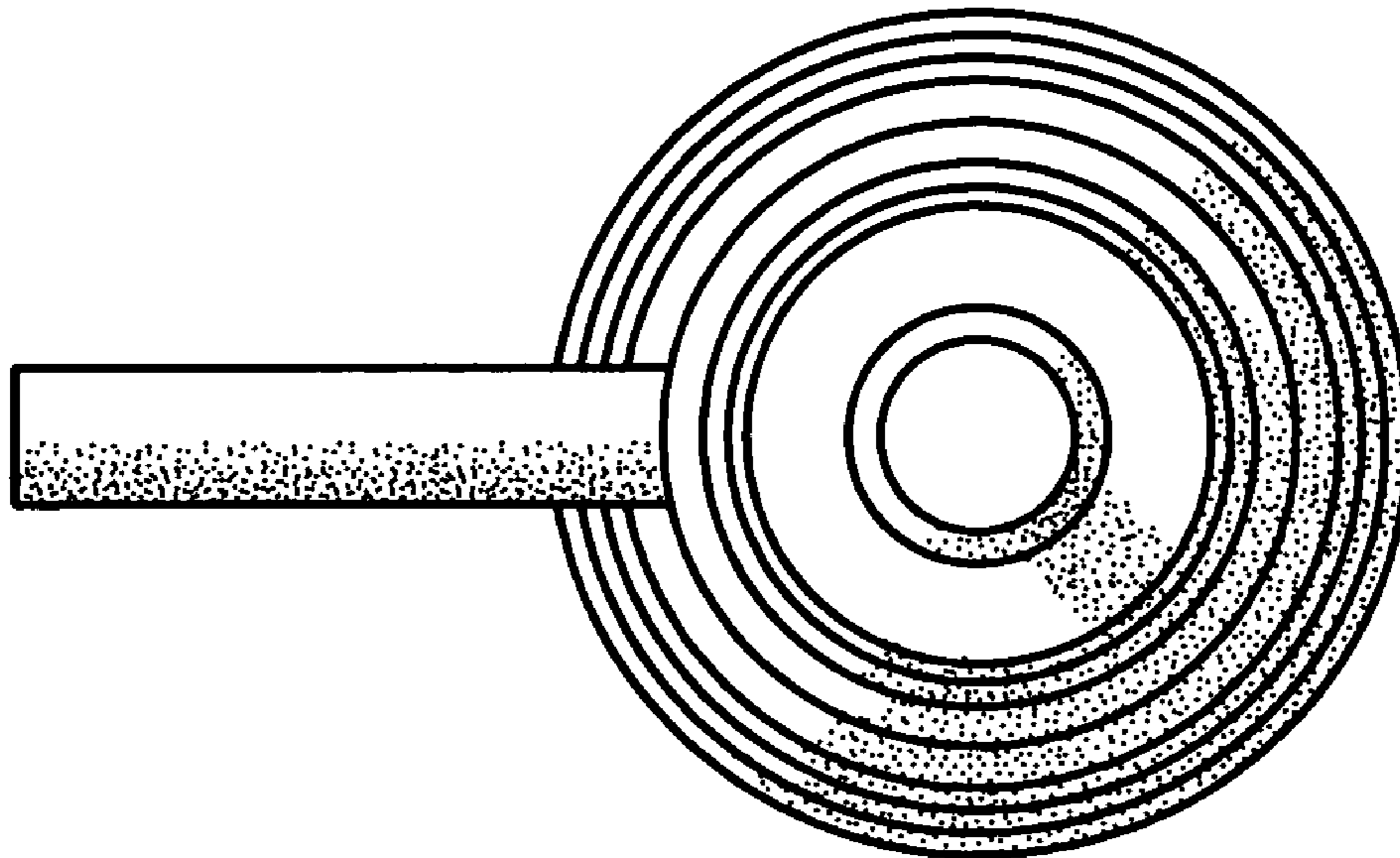

Fig. 6

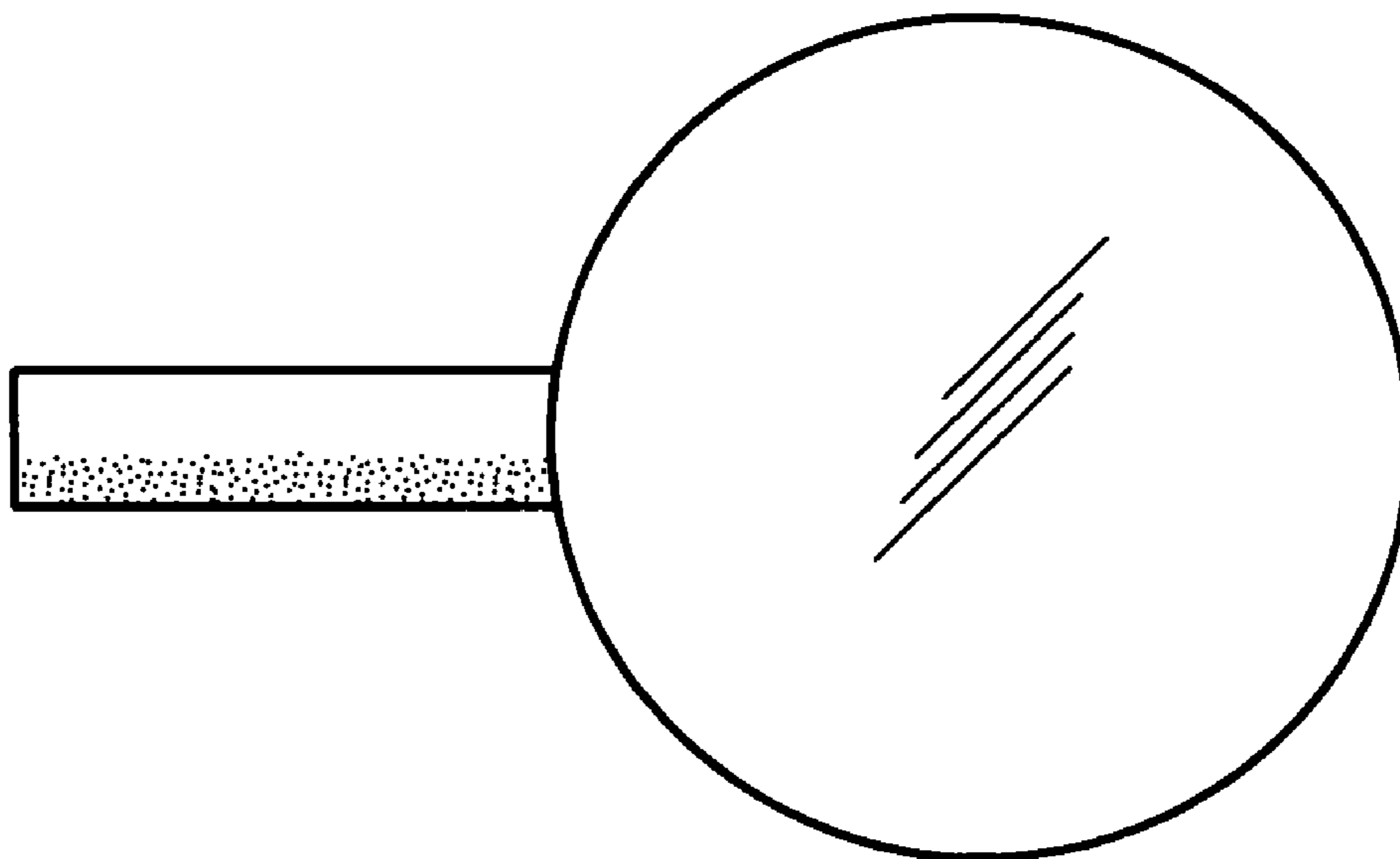

Fig. 7

