



US00D667590S

(12) **United States Design Patent**  
**Williams**

(10) **Patent No.:** **US D667,590 S**

(45) **Date of Patent:** **\*\* Sep. 18, 2012**

(54) **HELMET**

(75) Inventor: **Mark Williams**, Witney (GB)

(73) Assignee: **JSP Limited**, Gloucestershire (GB)

(\*\*) Term: **14 Years**

(21) Appl. No.: **29/399,712**

(22) Filed: **Aug. 17, 2011**

(30) **Foreign Application Priority Data**

Jun. 7, 2011 (EM) ..... 001874207

(51) **LOC (9) Cl.** ..... **07-02**

(52) **U.S. Cl.** ..... **D29/102**

(58) **Field of Classification Search** ..... D29/102-107,  
D29/122; 2/421, 423-425, 6.3, 6.5-6.7,  
2/411, 413, 414, 5, 427, 428, 9, 173, 206,  
2/209.13, 205, 909, 417; 446/27; D2/872,  
D2/873, 869

See application file for complete search history.

(56) **References Cited**

**U.S. PATENT DOCUMENTS**

D198,776 S *	8/1964	Simpson et al.	.....	D29/104
D228,264 S *	9/1973	Potter	.....	D29/104
D277,425 S *	2/1985	Higginson	.....	D29/104
D300,275 S *	3/1989	Sjogren et al.	.....	D29/104
D354,376 S *	1/1995	Kun	.....	D29/104
D370,308 S *	5/1996	Nilsson	.....	D29/102
5,810,467 A *	9/1998	Hurwitz	.....	362/106

D433,776 S *	11/2000	Scanlon	.....	D29/102
D498,880 S *	11/2004	Jones	.....	D29/104
6,964,066 B2 *	11/2005	Tucker	.....	2/414
D524,990 S *	7/2006	Steinhobel	.....	D29/103
D575,905 S *	8/2008	Davis et al.	.....	D29/102
D600,412 S *	9/2009	Ochoa	.....	D29/102
D648,899 S *	11/2011	Westerdal	.....	D29/102

\* cited by examiner

*Primary Examiner* — Ruth McInroy

(74) *Attorney, Agent, or Firm* — Harris Beach PLLC; Neal L. Slikfin

(57) **CLAIM**

I claim the ornamental design for a helmet, as shown and described.

**DESCRIPTION**

FIG. 1 is a front perspective view of a helmet showing my new design;

FIG. 2 is a rear perspective view thereof;

FIG. 3 is a front elevation view thereof;

FIG. 4 is a rear elevation view thereof;

FIG. 5 is a right side elevation view thereof;

FIG. 6 is a left side elevation view thereof;

FIG. 7 is a top plan view thereof;

FIG. 8 is a bottom plan view thereof;

FIG. 9 is a bottom perspective view thereof; and,

FIG. 10 is a bottom perspective view of the opposite side of FIG. 9.

**1 Claim, 10 Drawing Sheets**

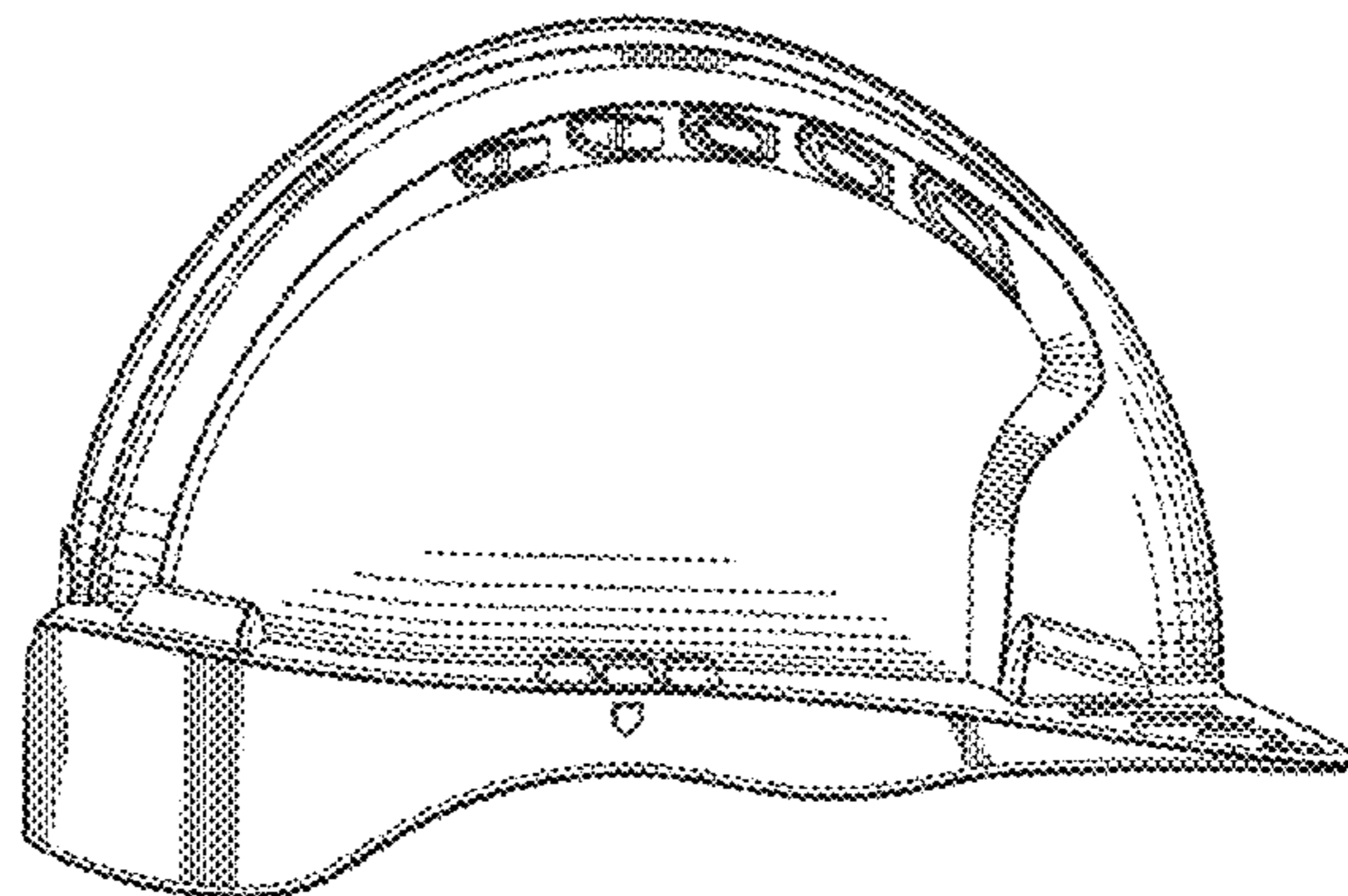
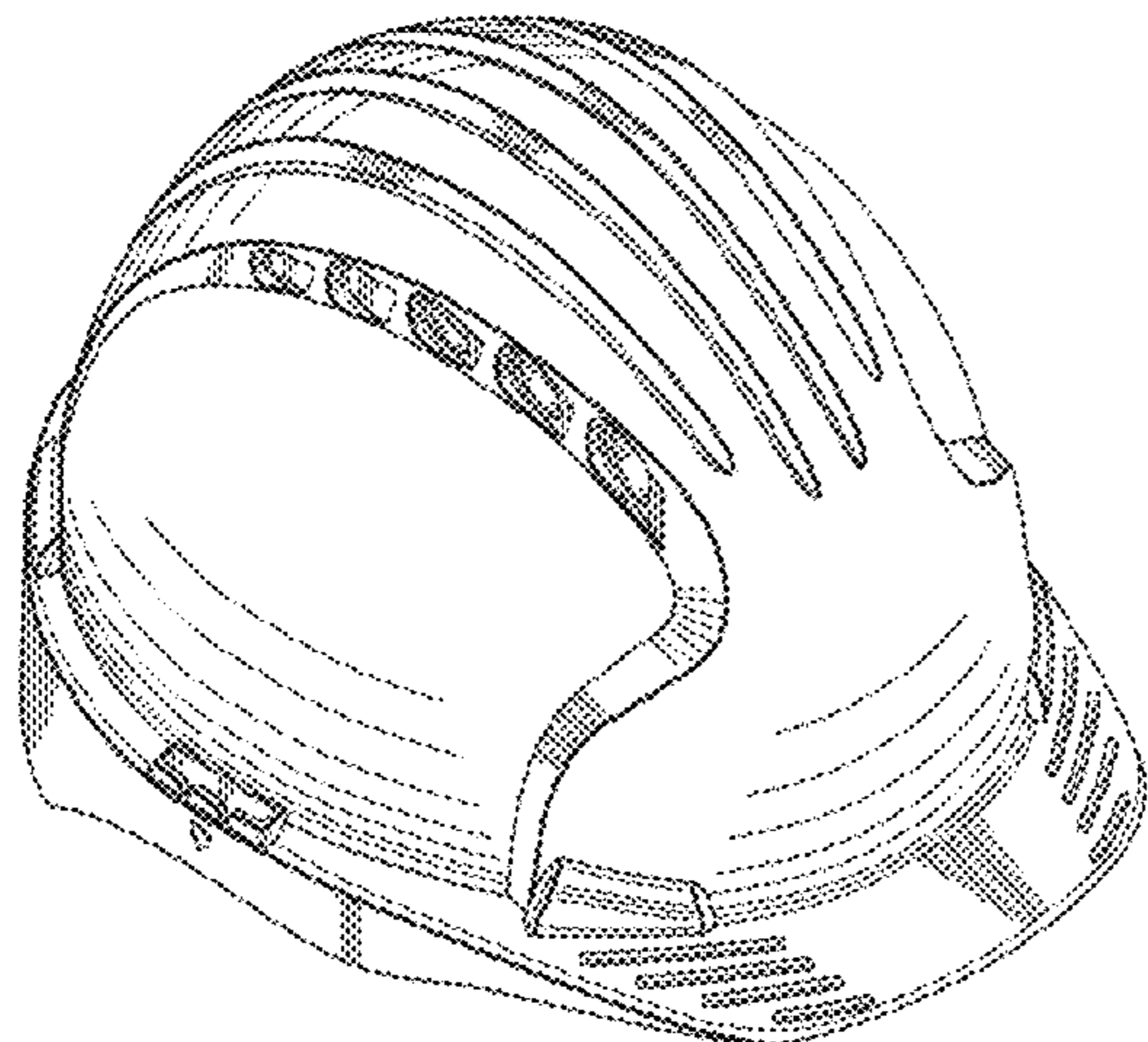

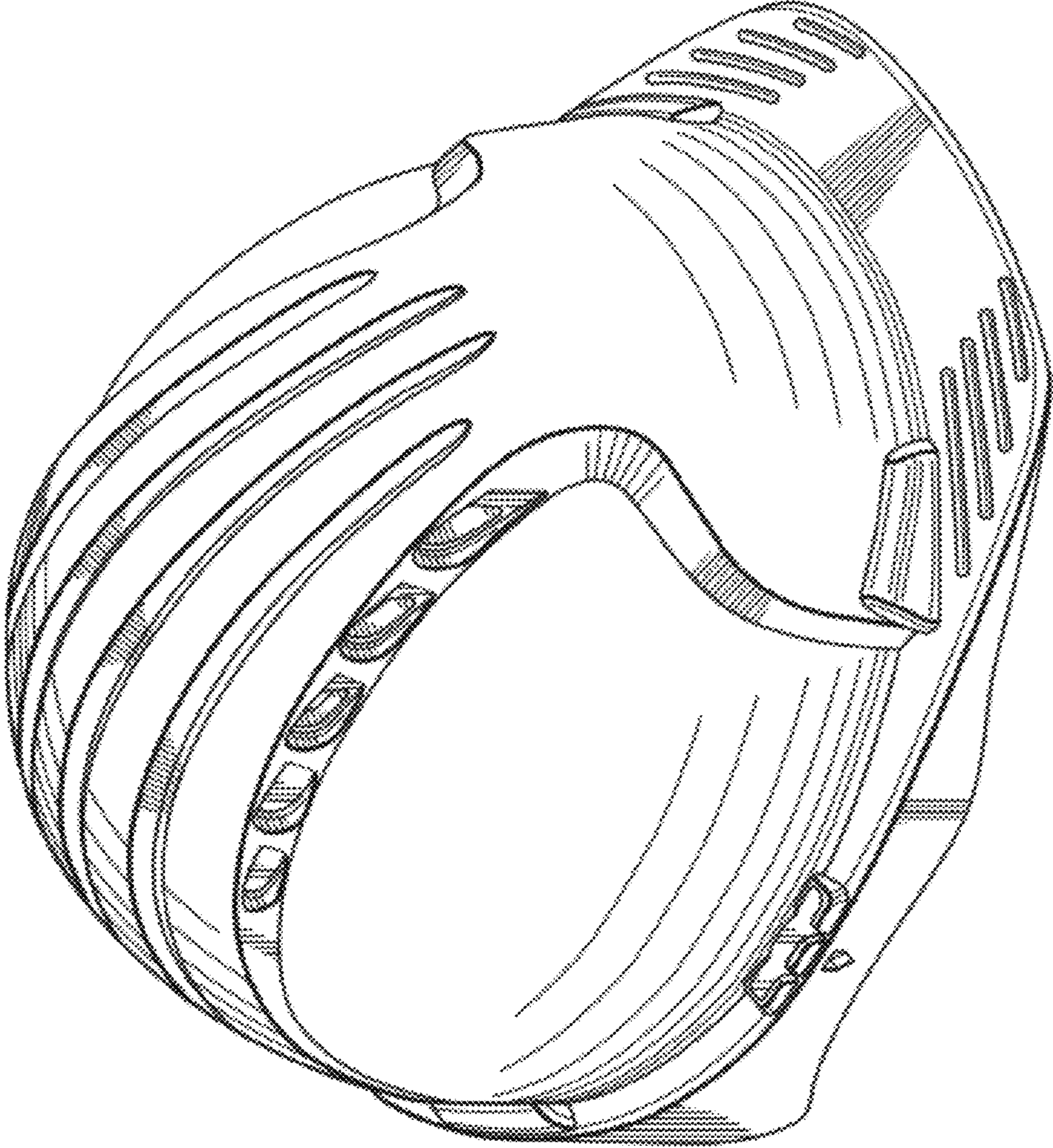

FIG. 1

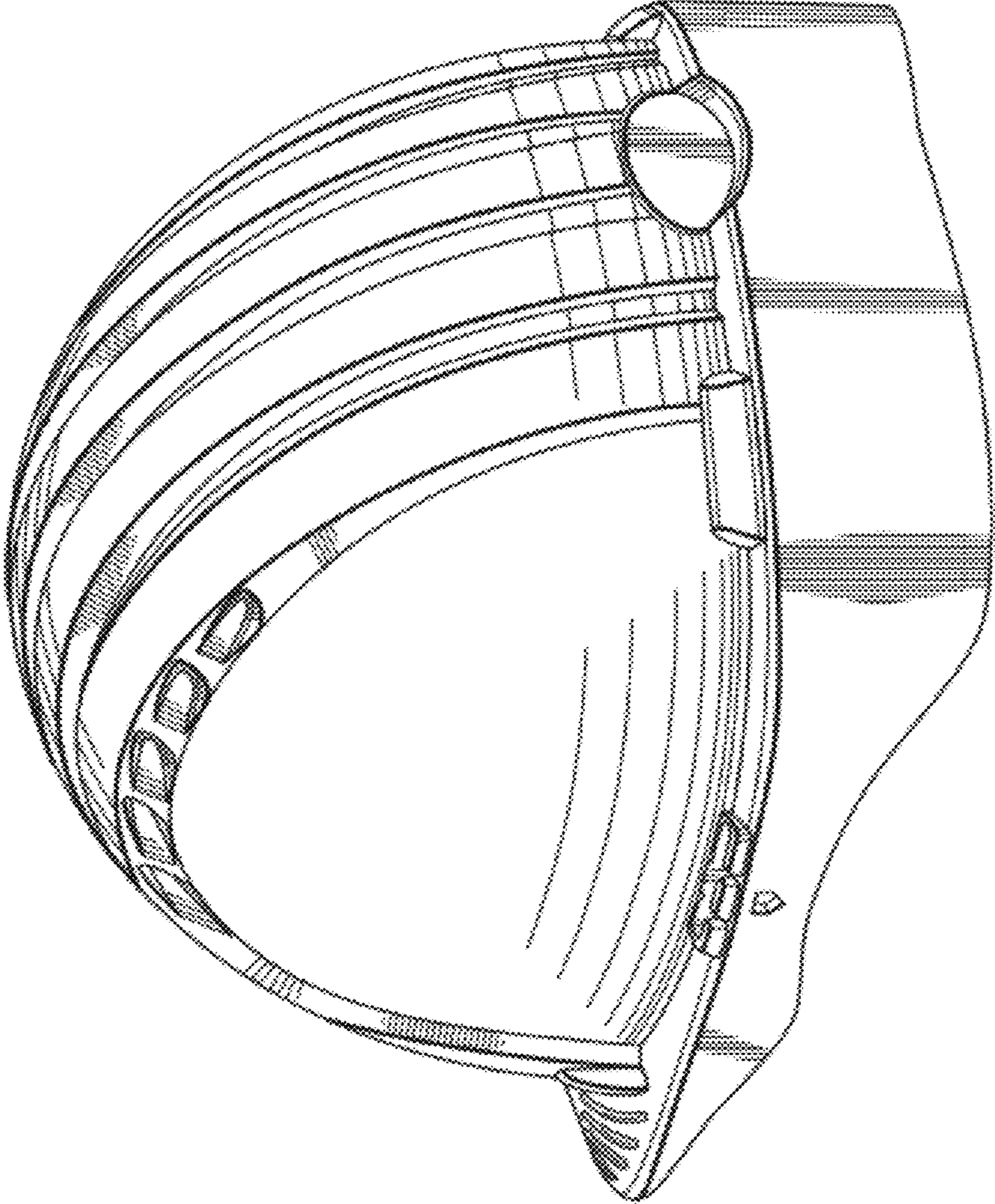

FIG. 2

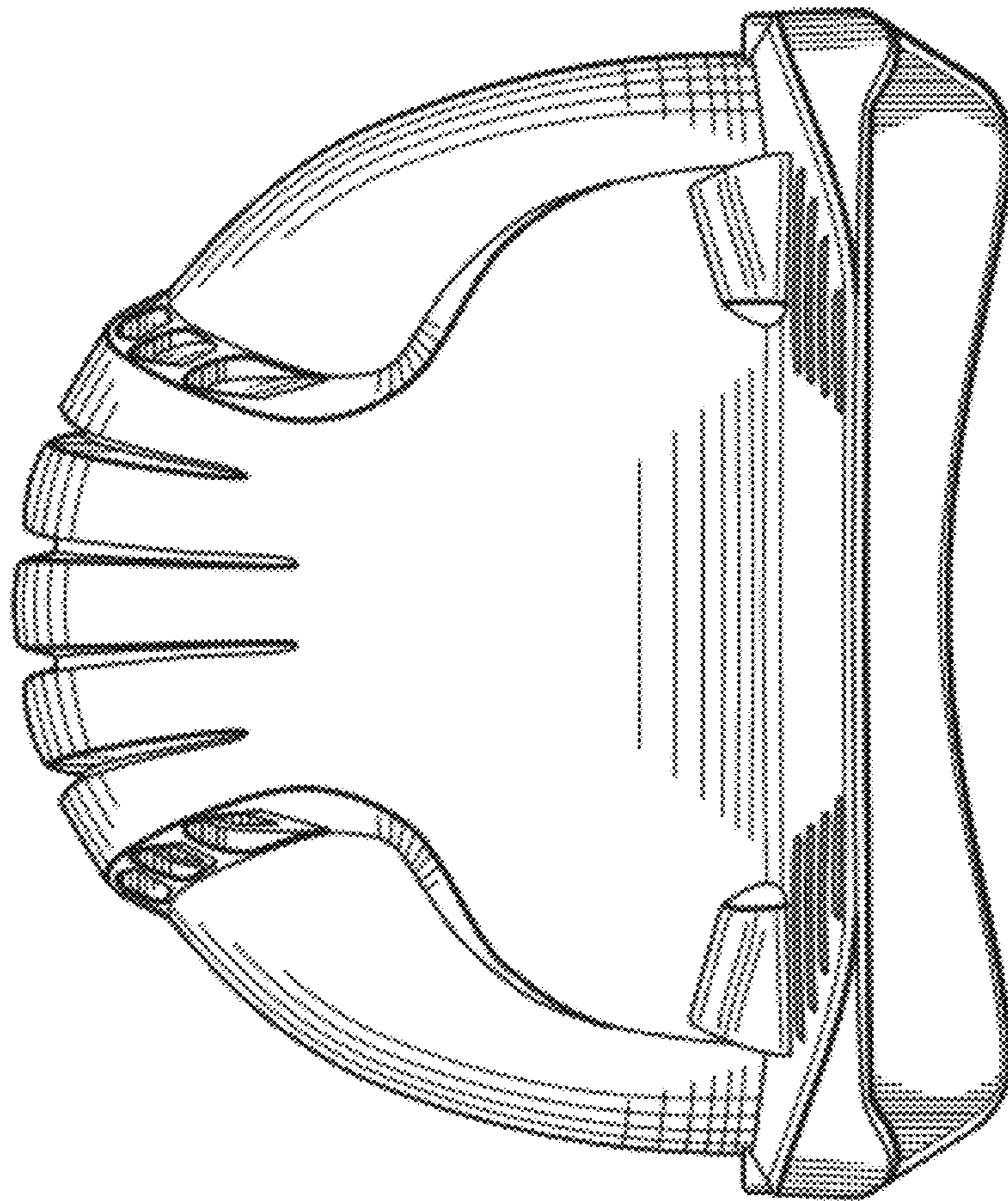

FIG. 3

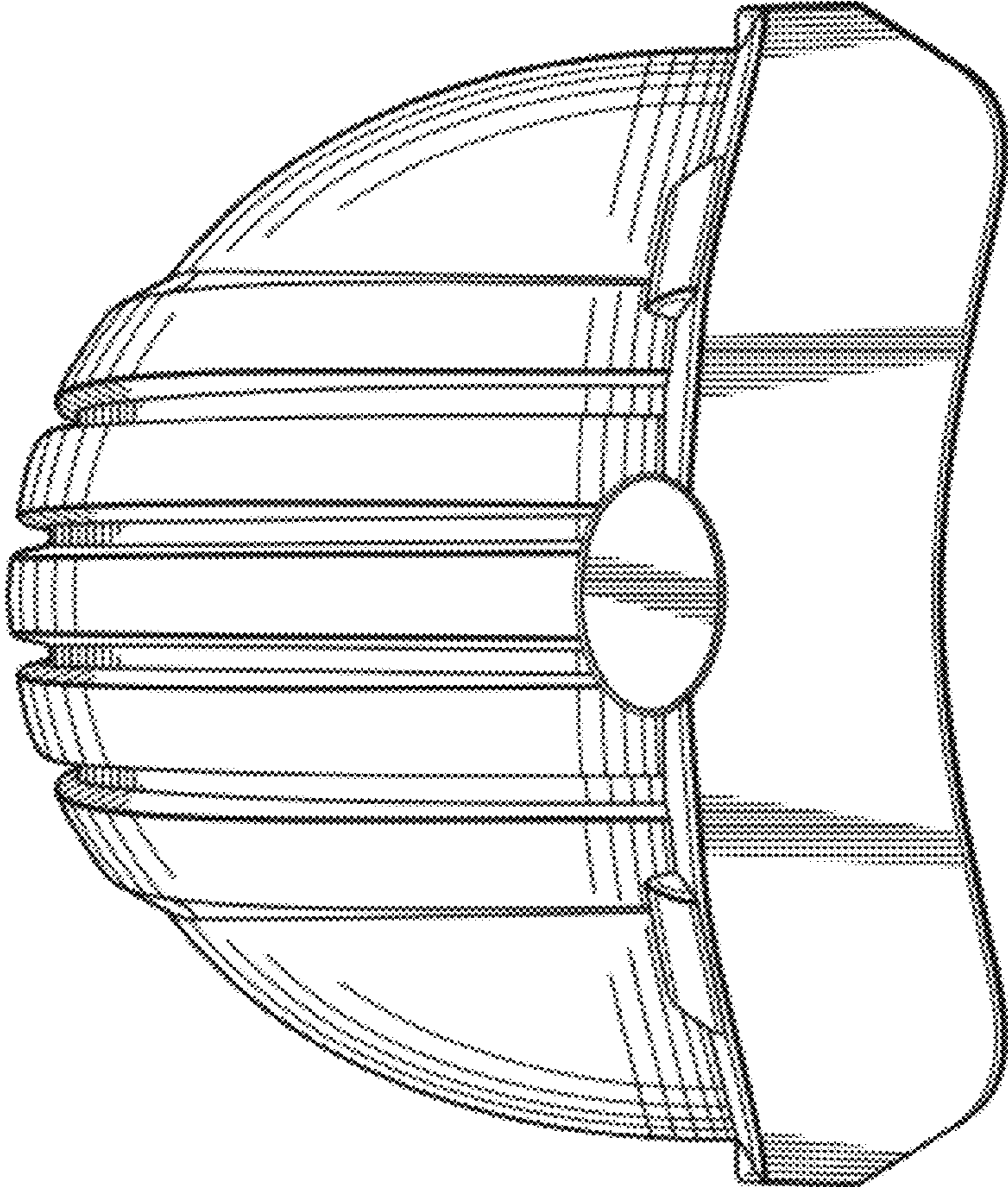

FIG. 4

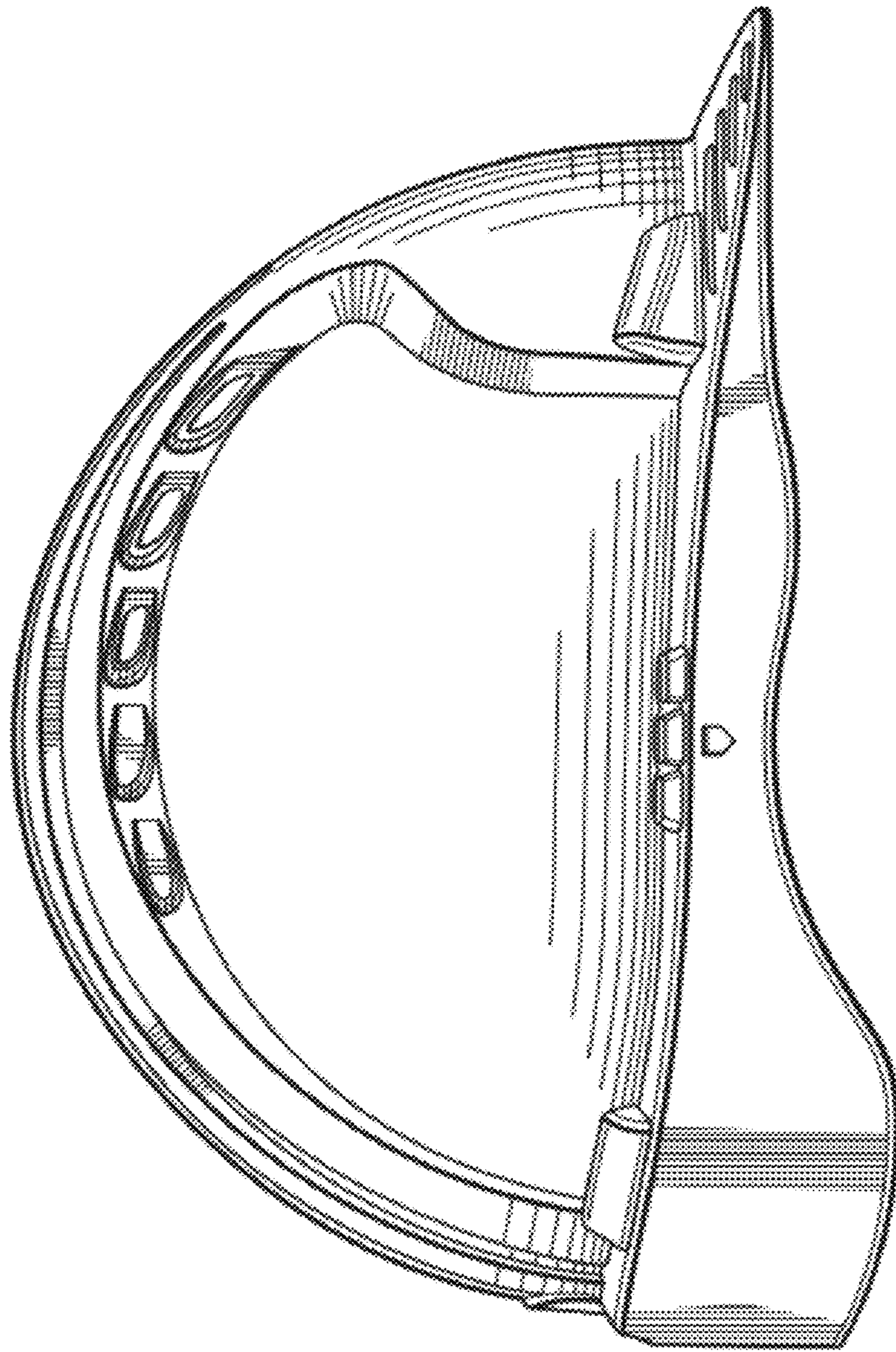

FIG. 5

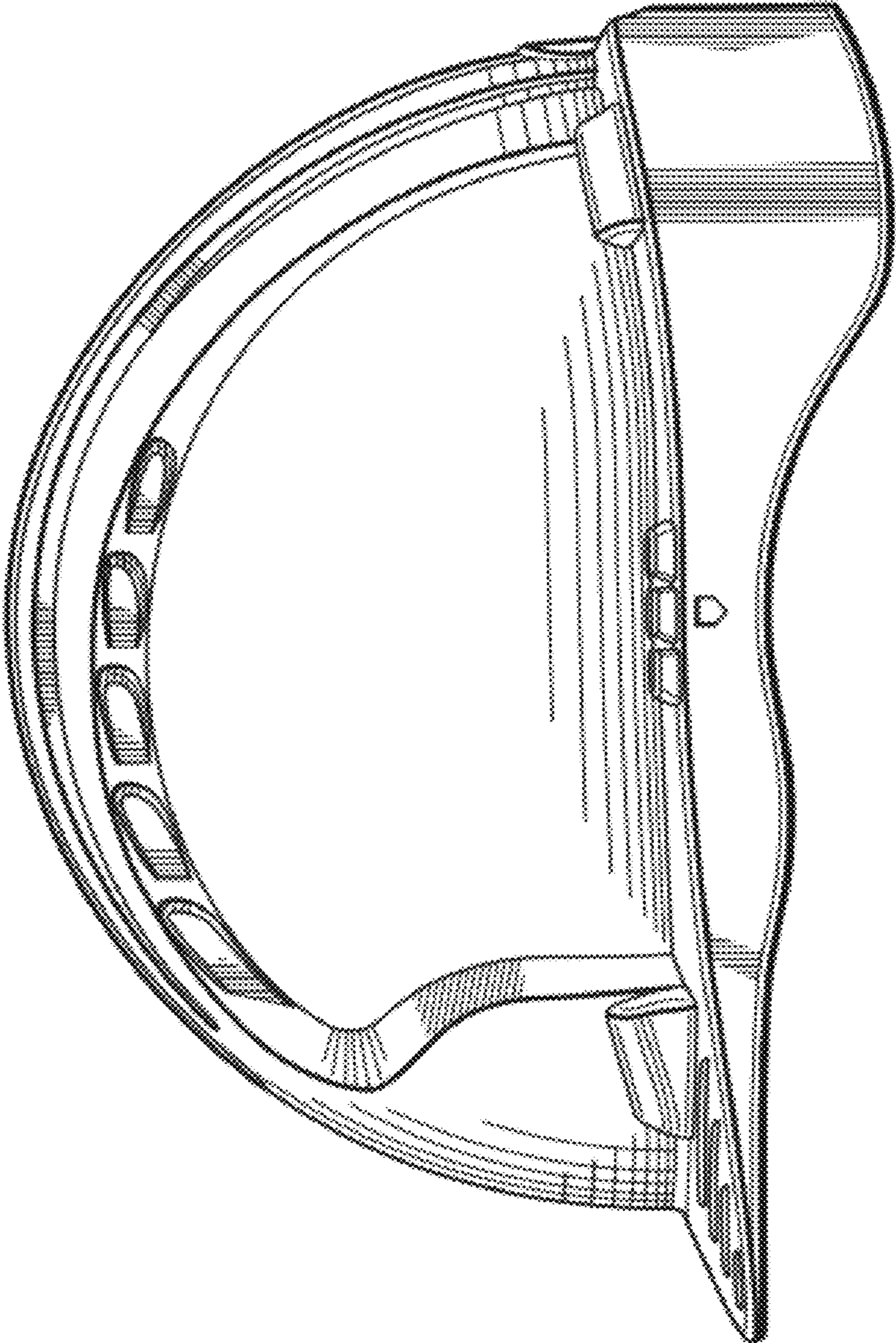

FIG. 6

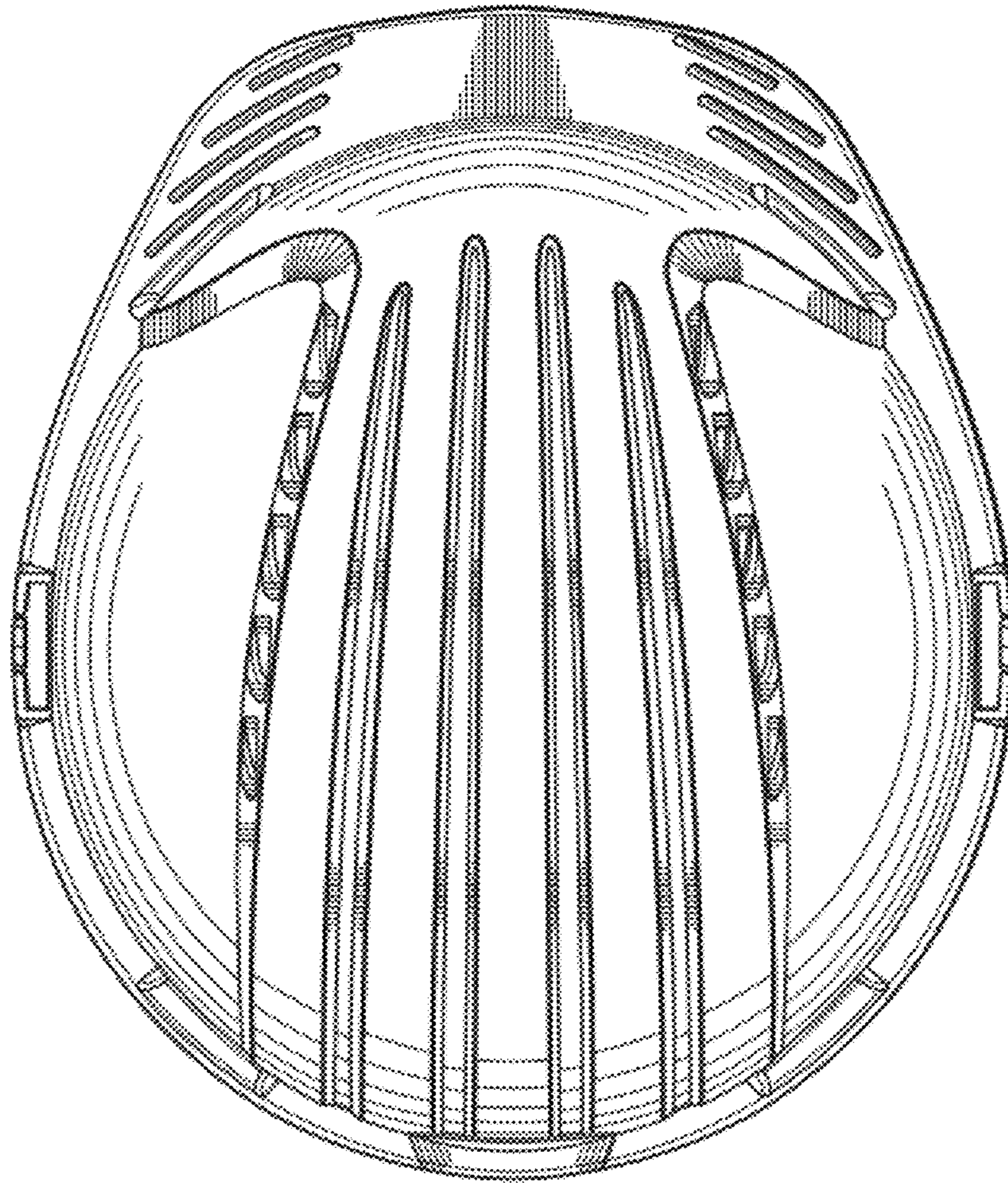

FIG. 7



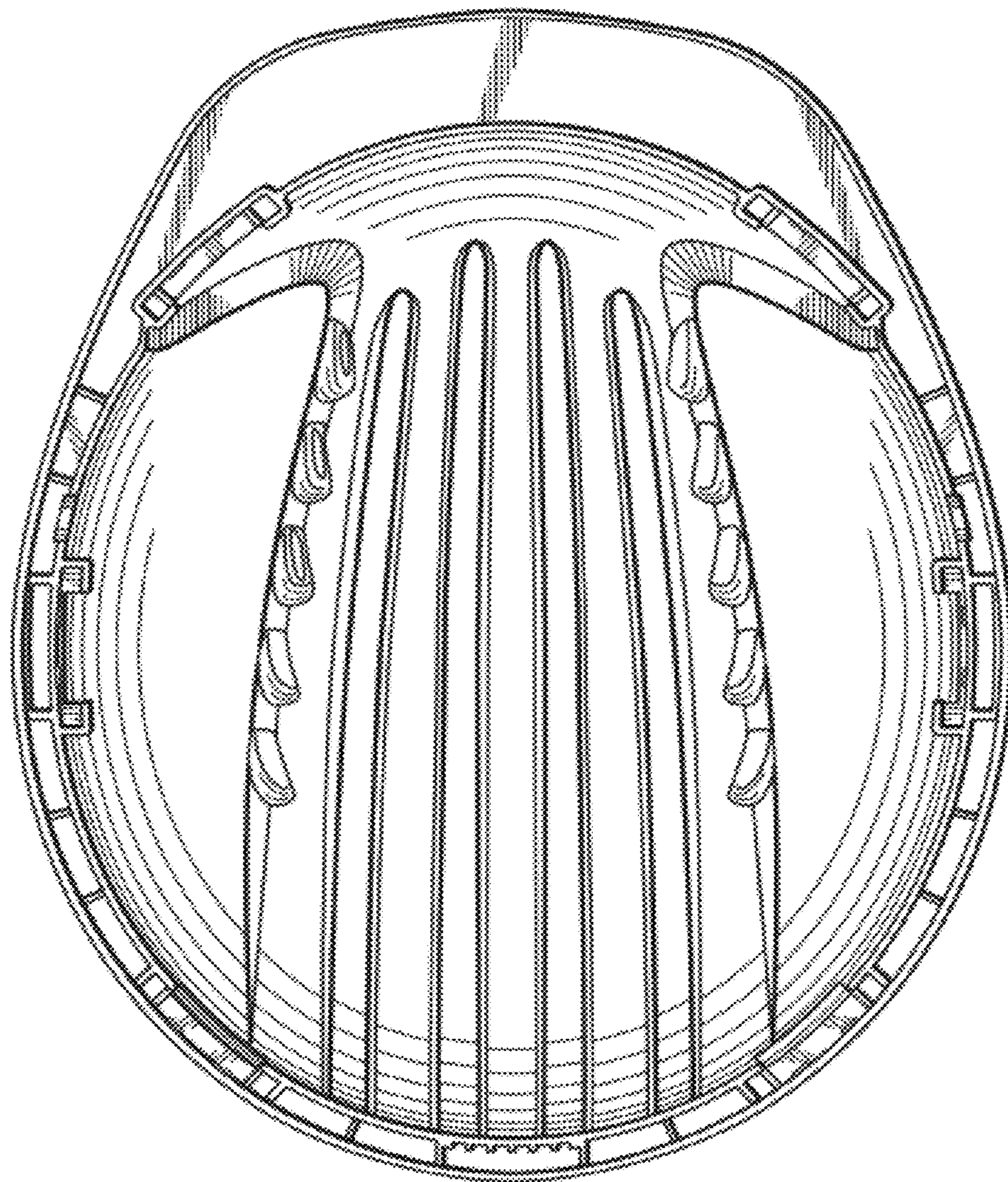

FIG. 8

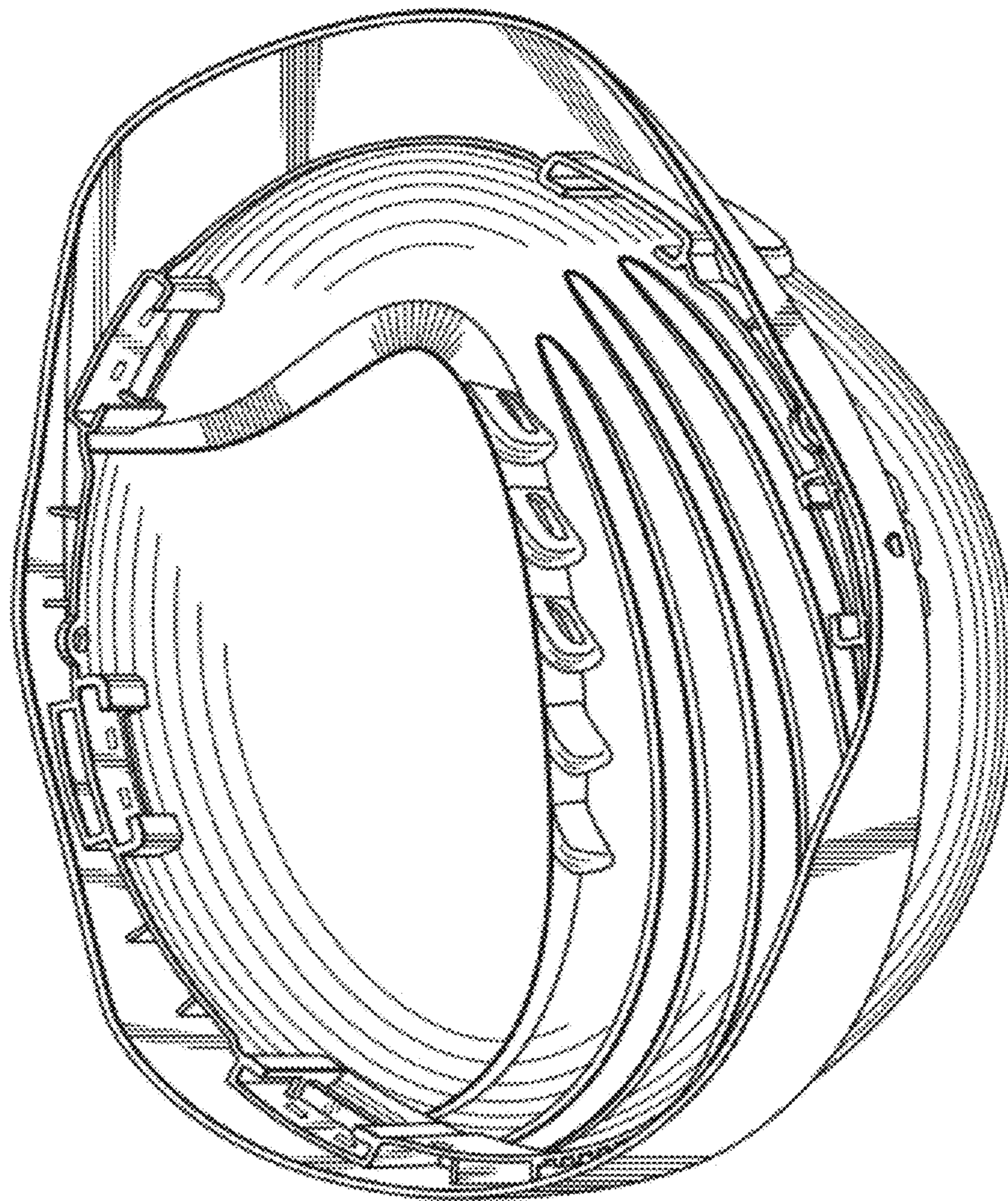

FIG. 9

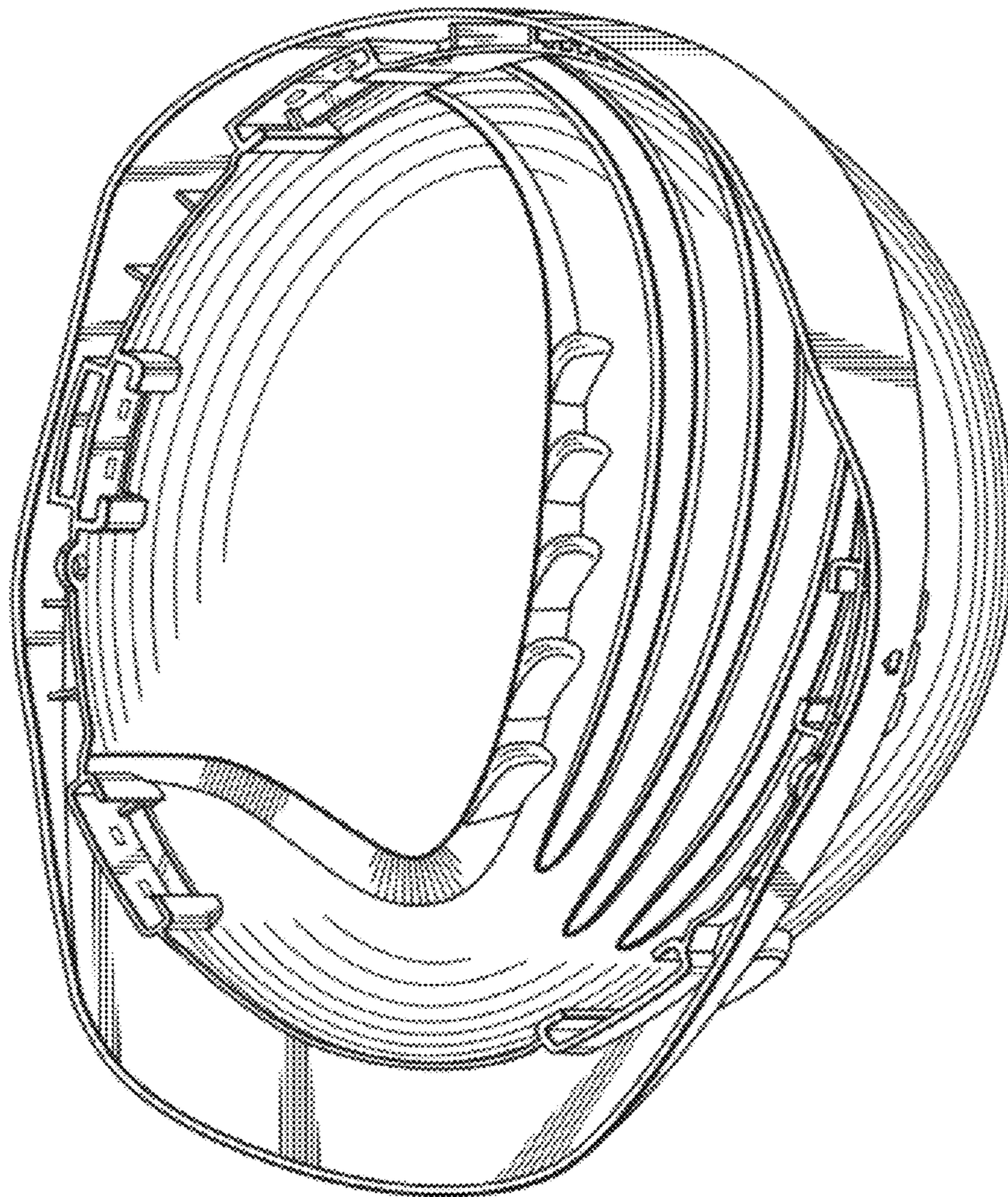

FIG. 10