

US00D667560S

(12) **United States Design Patent**
Caggiano et al.

(10) **Patent No.:** **US D667,560 S**

(45) **Date of Patent:** **** Sep. 18, 2012**

(54) **PERSONAL VIBRATOR IN THE SHAPE OF A MAKEUP BRUSH**

(75) Inventors: **Keith Caggiano**, Playa del Rey, CA (US); **Justin Ross**, Beverly Hills, CA (US)

(73) Assignee: **Momentum Management, LLC**, Torrance, CA (US)

(**) Term: **14 Years**

(21) Appl. No.: **29/374,981**

(22) Filed: **Nov. 2, 2011**

(51) **LOC (9) Cl.** **28-03**

(52) **U.S. Cl.** **D24/215**

(58) **Field of Classification Search** D24/200, D24/211-215, 141; 601/27, 28, 33, 40, 46, 601/47, 48, 63, 80, 99, 104, 112, 113, 114, 601/119, 122, 125, 129, 134, 135, 137, DIG. 12, 601/DIG. 13, DIG. 14, DIG. 15, DIG. 16, 601/DIG. 17; D28/4, 8, 76, 85, 88; D4/128, D4/129, 132, 133

See application file for complete search history.

(56) **References Cited**

U.S. PATENT DOCUMENTS

D510,440 S * 10/2005 Huang D24/211
7,044,938 B2 * 5/2006 La Bianco et al. 604/290
2011/0091265 A1 * 4/2011 Zhang 401/195
* cited by examiner

Primary Examiner — Sandra Snapp
(74) *Attorney, Agent, or Firm* — Thomas I. Rozsa

(57) **CLAIM**

The ornamental design for a personal vibrator in the shape of a makeup brush, as shown and described.

DESCRIPTION

FIG. 1 is a side perspective view of the personal vibrator in the shape of a makeup brush showing the entire design, showing our design;
FIG. 2 is bottom perspective view thereof;
FIG. 3 is a front view thereof;
FIG. 4 is a rear view thereof;
FIG. 5 is a left side view thereof;
FIG. 6 is a right side view thereof;
FIG. 7 is a top view thereof; and,
FIG. 8 is a bottom view thereof.

1 Claim, 5 Drawing Sheets

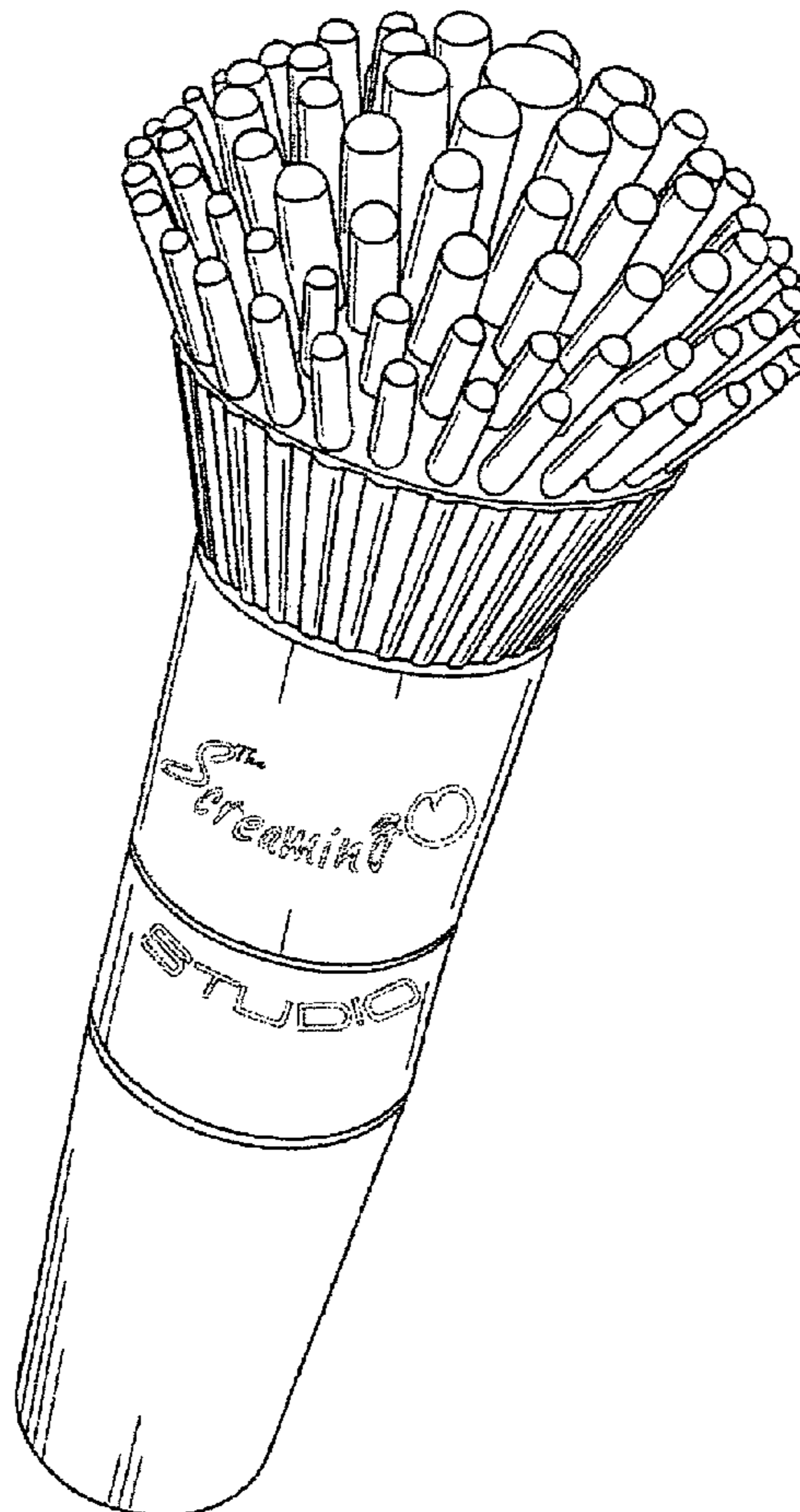

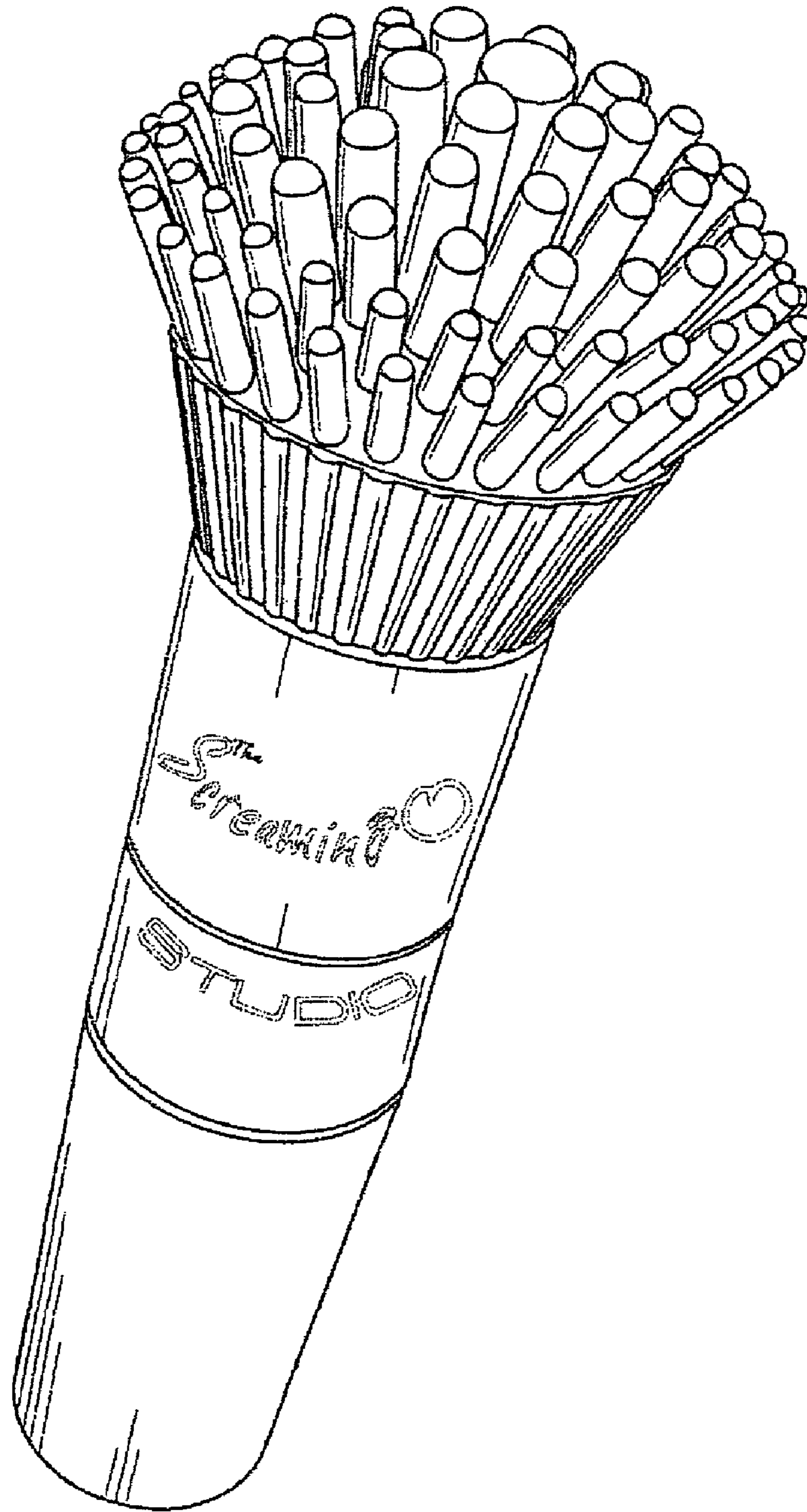

FIG. 1

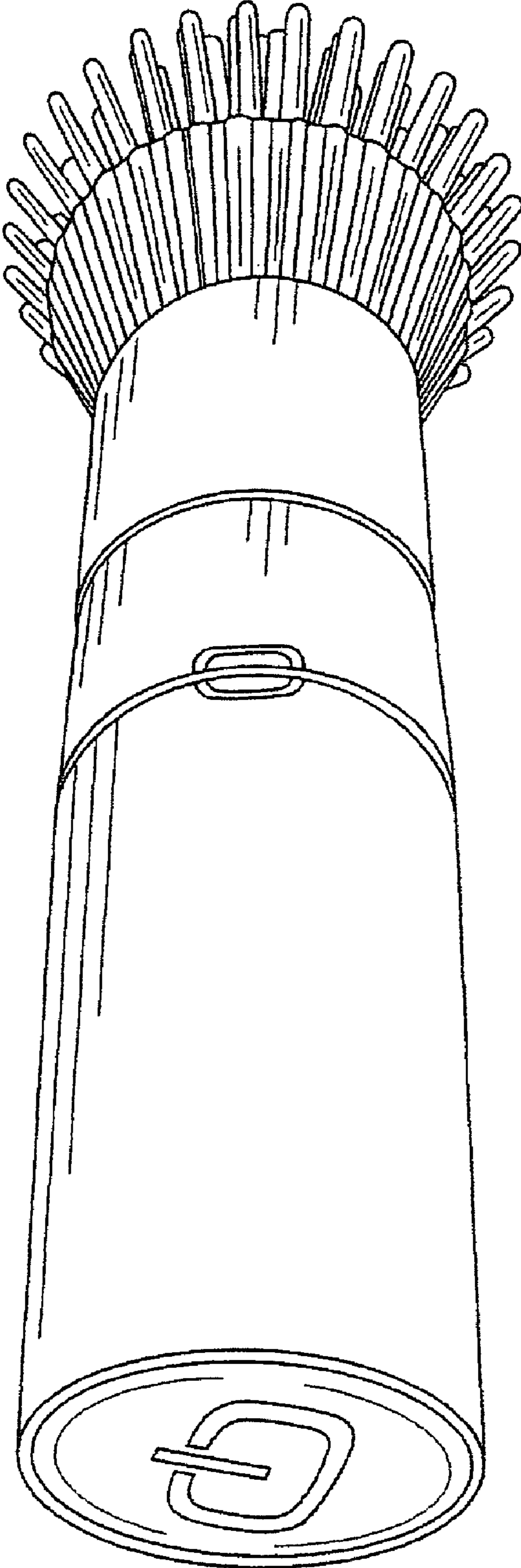

FIG. 2

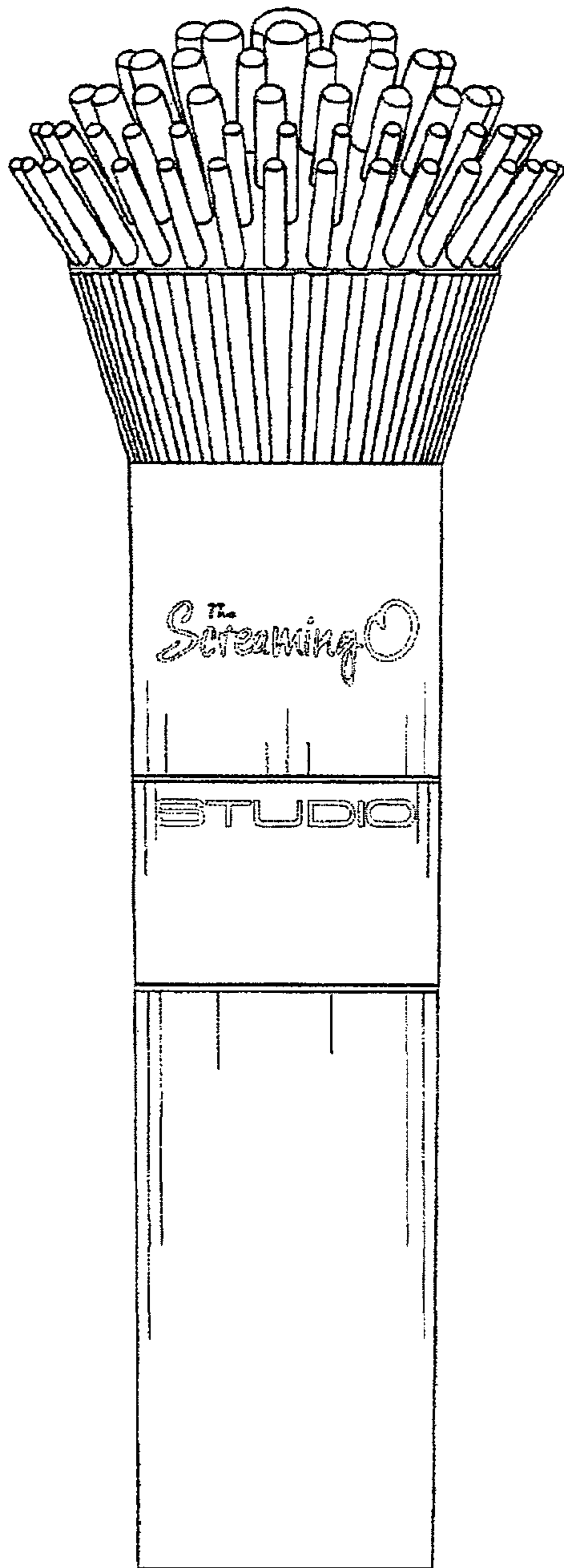

FIG. 3

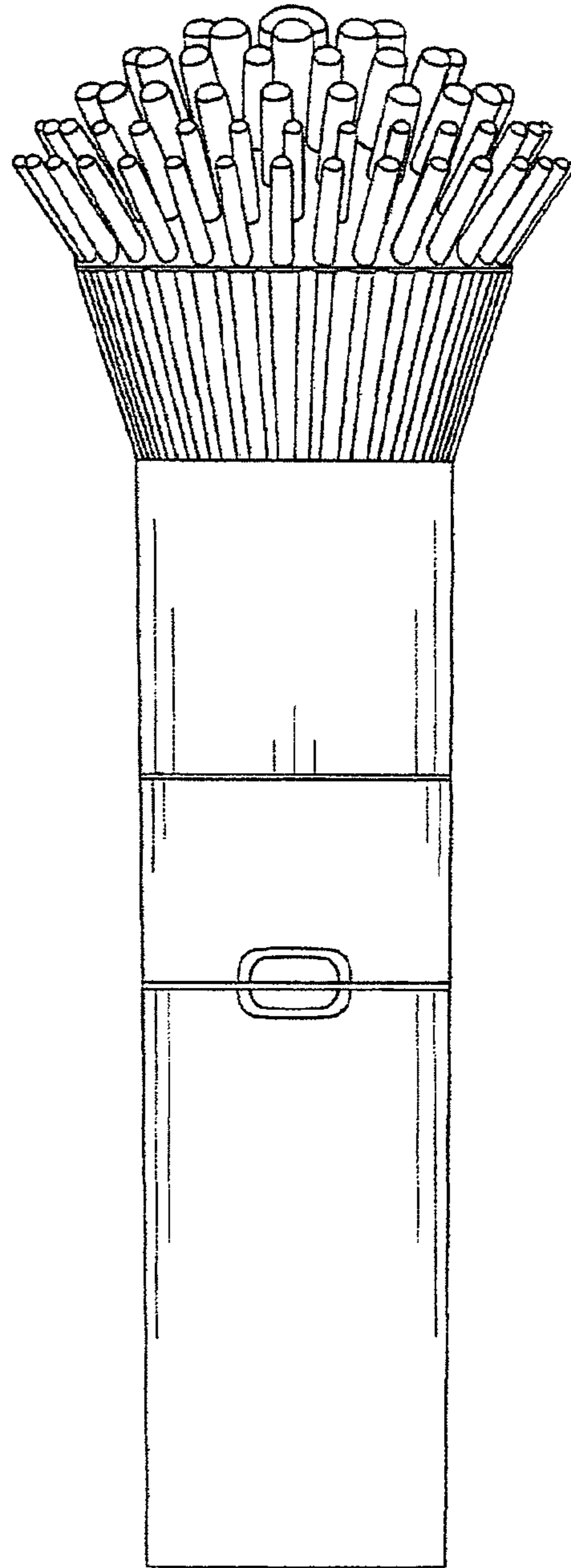

FIG. 4

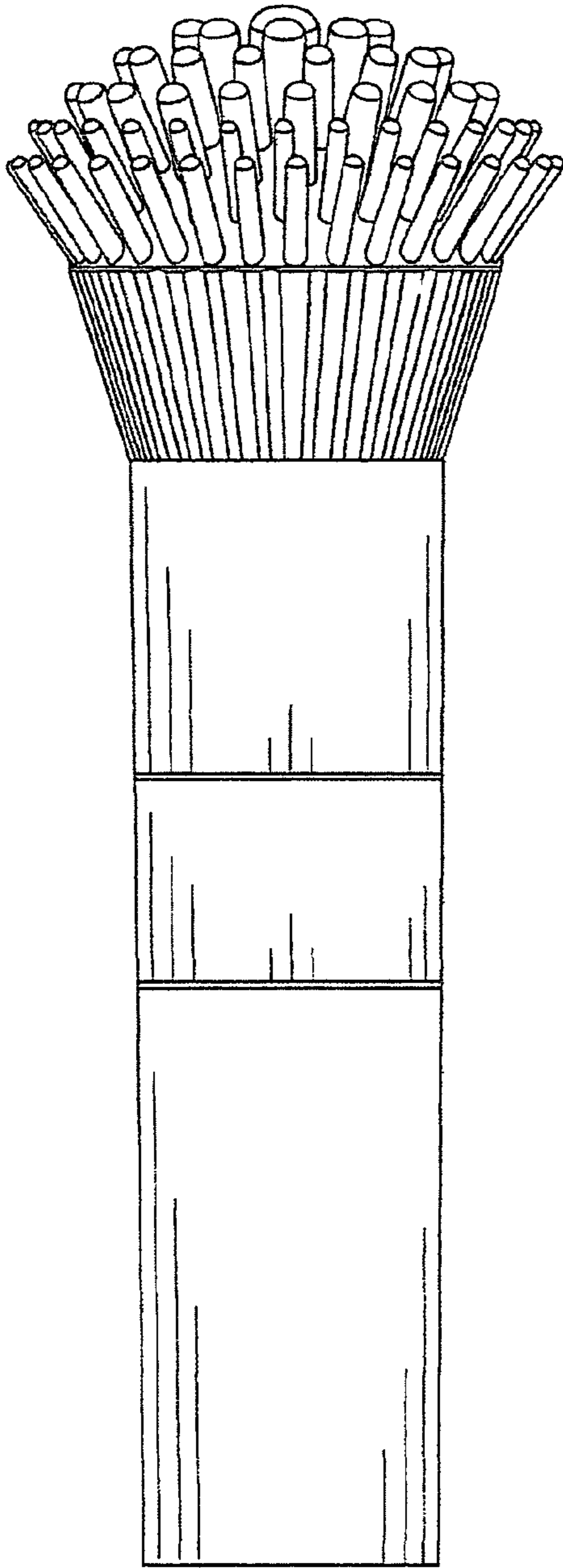

FIG. 5

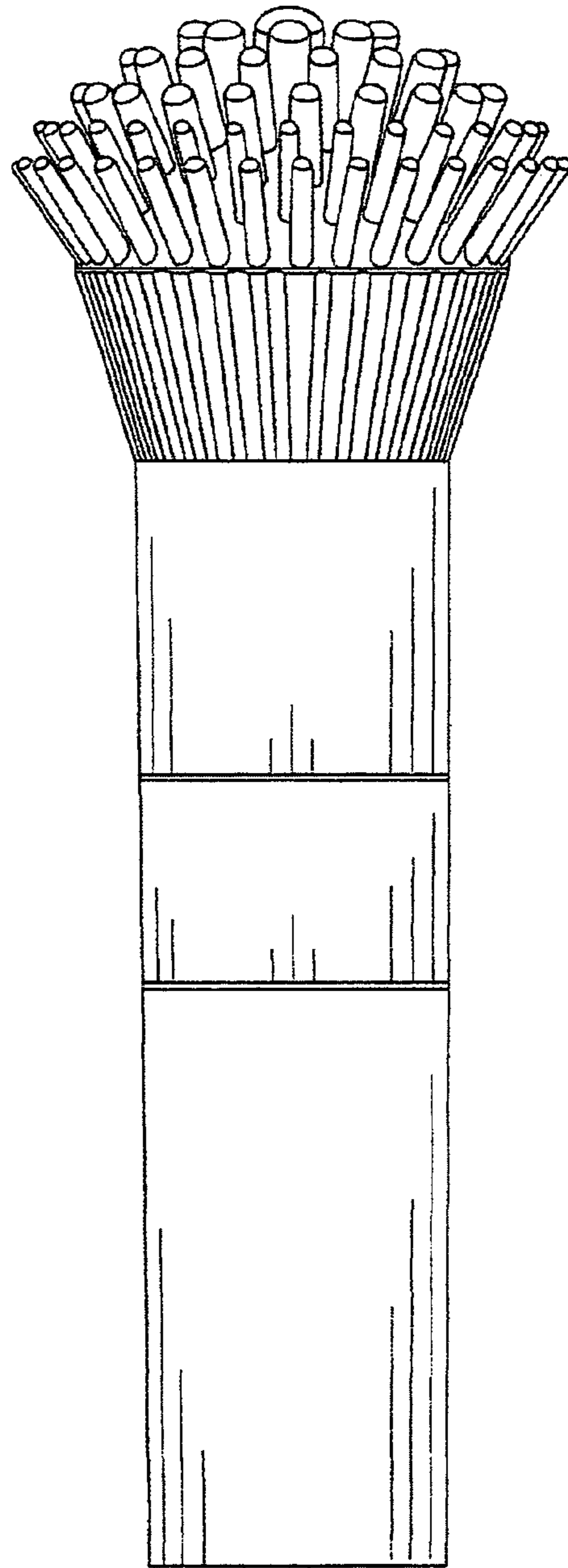

FIG. 6

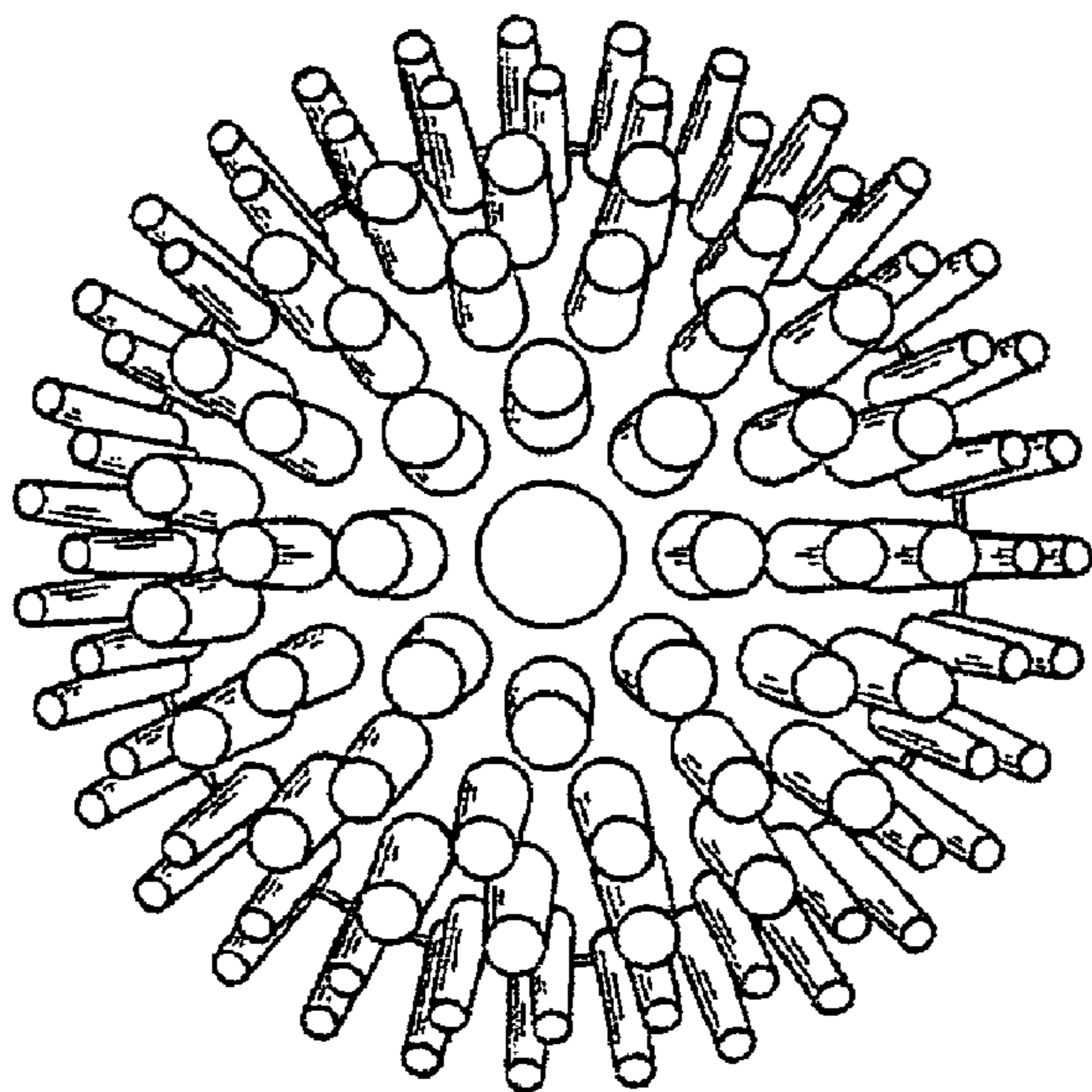

FIG. 7

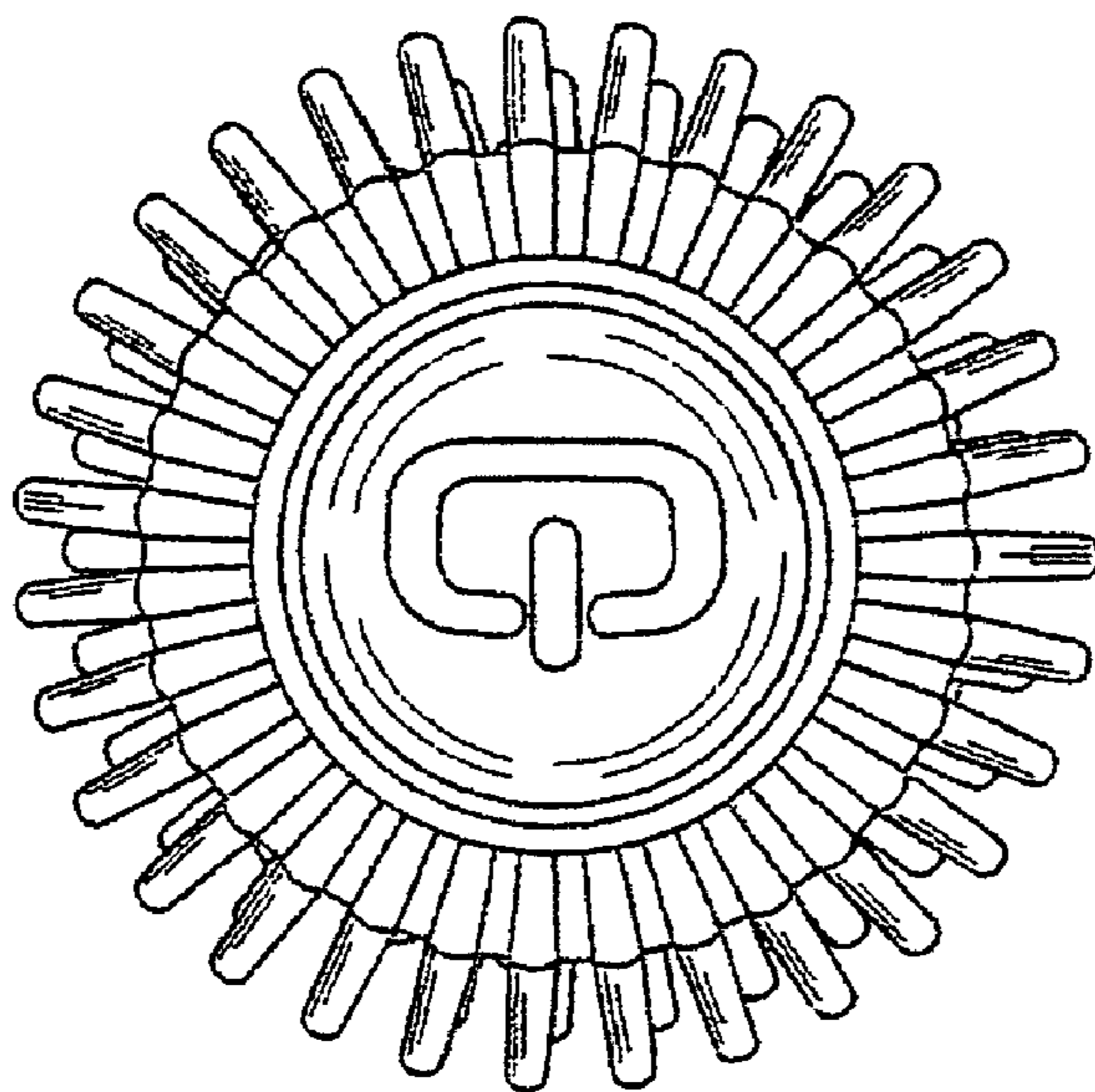

FIG. 8