

US00D667532S

(12) **United States Design Patent**
Asaba

(10) **Patent No.:** **US D667,532 S**

(45) **Date of Patent:** **** Sep. 18, 2012**

(54) **FLUID PRESSURE CYLINDER**

(75) Inventor: **Tsuyoshi Asaba**, Tsukubamirai (JP)

(73) Assignee: **SMC Corporation**, Chiyoda-ku, Tokyo (JP)

(**) Term: **14 Years**

(21) Appl. No.: **29/376,350**

(22) Filed: **Oct. 6, 2010**

(30) **Foreign Application Priority Data**

Jun. 4, 2010 (JP) 2010-013771

(51) **LOC (9) Cl.** **23-01**

(52) **U.S. Cl.** **D23/233; D10/85**

(58) **Field of Classification Search** D10/85,
D10/86; D15/143; D23/200, 207, 209, 210,
D23/233-237, 244-249, 259-269, 310; 73/700;
91/394, 395, 407, 408; 92/28, 51, 52, 88,
92/143, 177; 137/625.4, 625.64, 625.65

See application file for complete search history.

(56) **References Cited**

U.S. PATENT DOCUMENTS

D378,214 S * 2/1997 Ikumi D15/143
D556,861 S * 12/2007 Yokohari D23/233

D556,862 S * 12/2007 Yokohari D23/233
D606,629 S * 12/2009 Tokumoto D23/233
D638,101 S * 5/2011 Kato D23/233
D660,191 S * 5/2012 Asaba D10/85

* cited by examiner

Primary Examiner — Garth Rademaker

(74) *Attorney, Agent, or Firm* — Yokoi & Co., U.S.A., Inc.;
Toshiyuki Yokoi

(57) **CLAIM**

The ornamental design for a fluid pressure cylinder, as shown and described.

DESCRIPTION

FIG. 1 shows a front view of a fluid pressure cylinder showing my new design;

FIG. 2 shows a rear view thereof;

FIG. 3 shows a right side view thereof;

FIG. 4 shows a left side view thereof;

FIG. 5 shows a top view thereof;

FIG. 6 shows a bottom view thereof; and,

FIG. 7 shows a top, front and left side perspective view thereof.

The broken lines in FIGS. 3, 5, 6 and 7 are included for the purpose of illustrating portions of the fluid pressure cylinder that form no part of the claimed design.

1 Claim, 5 Drawing Sheets

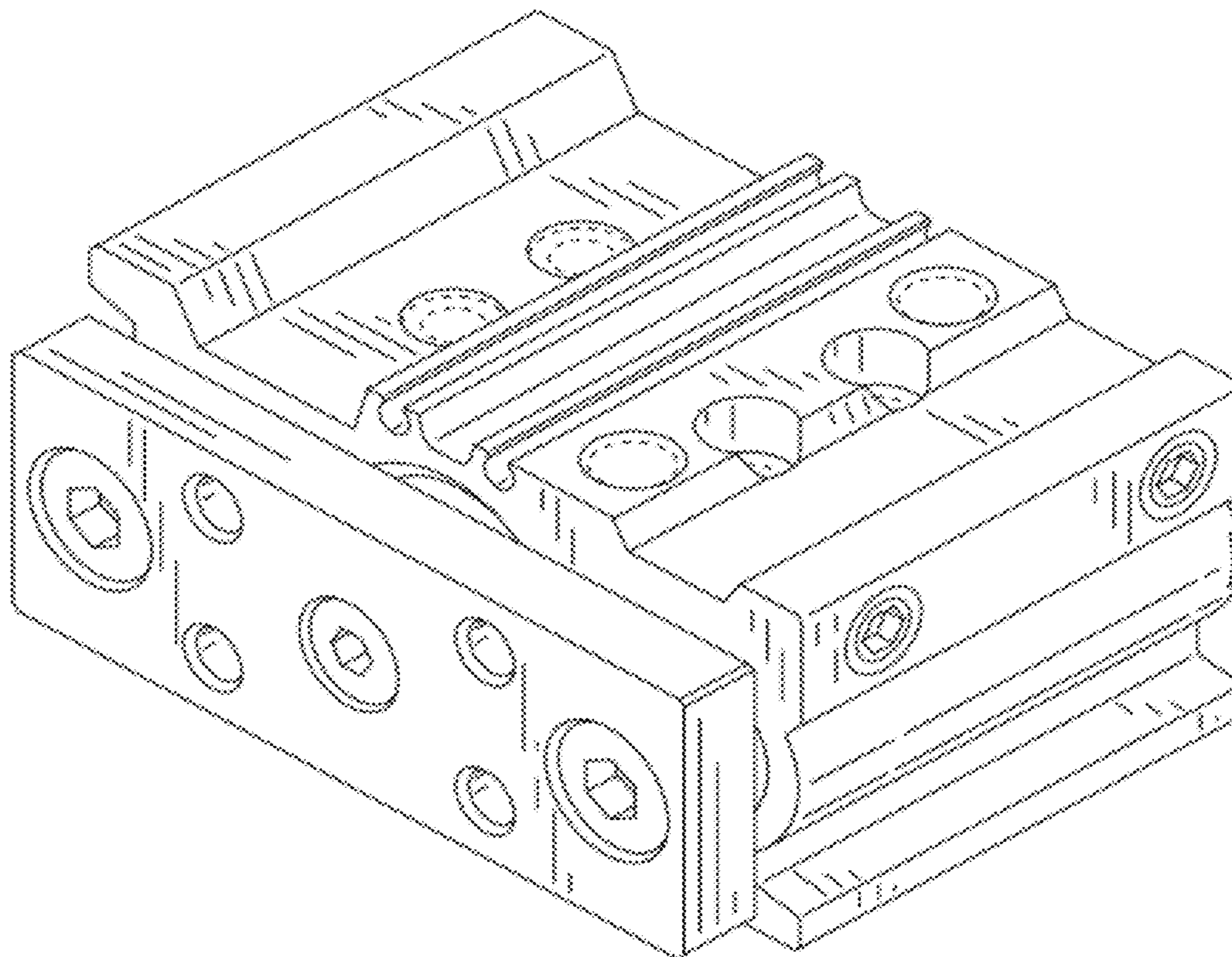

FIG. 1

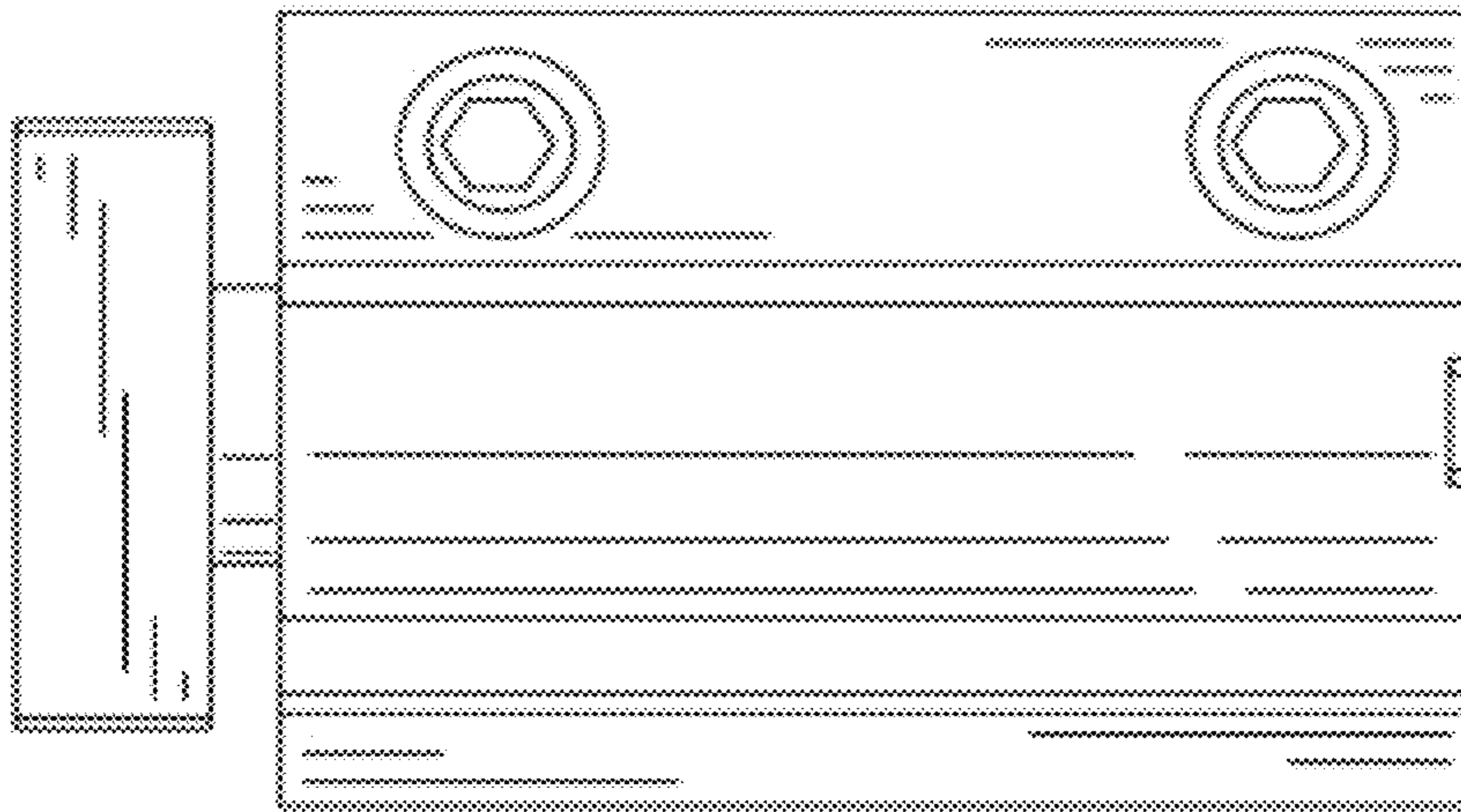

FIG. 2

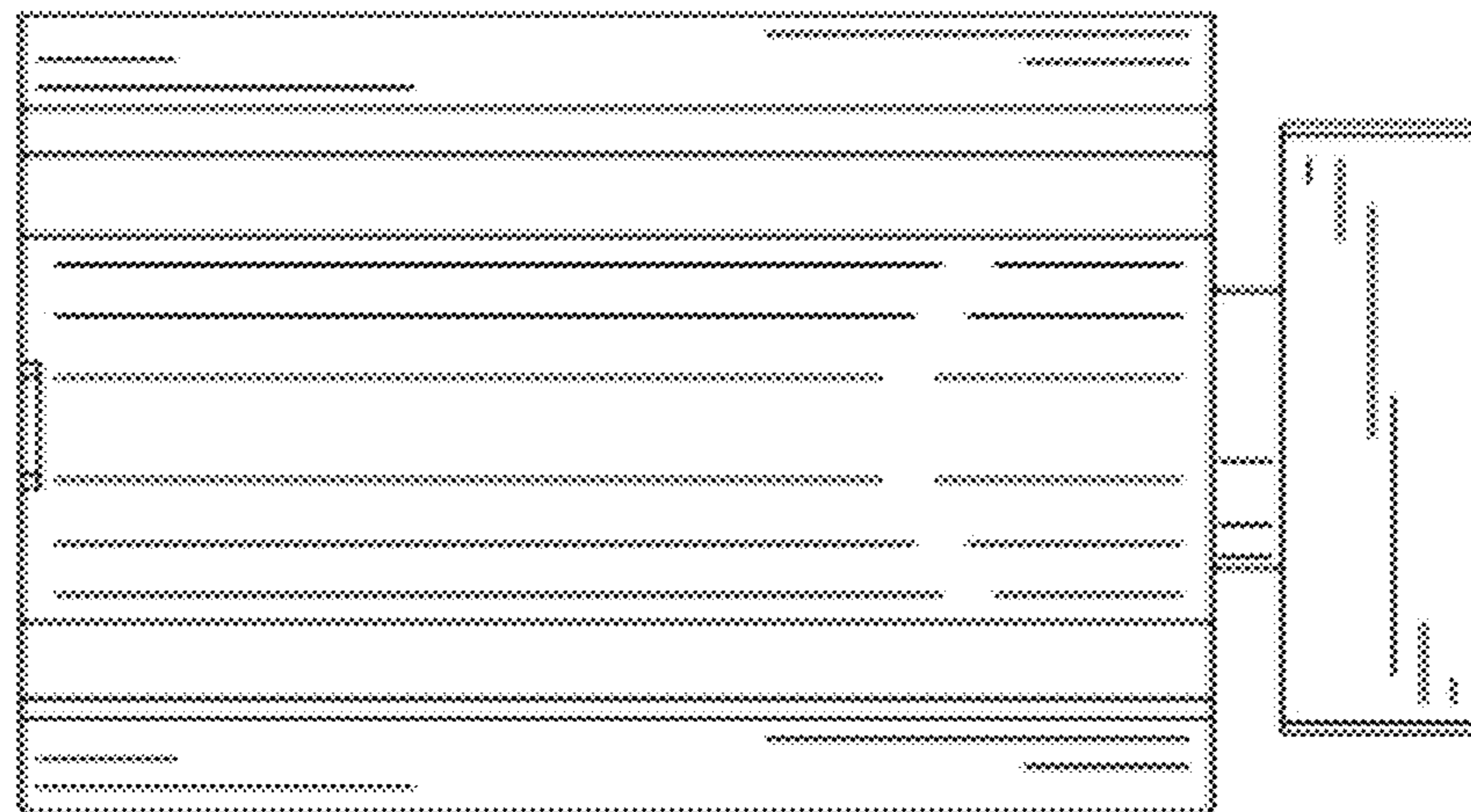

FIG. 3

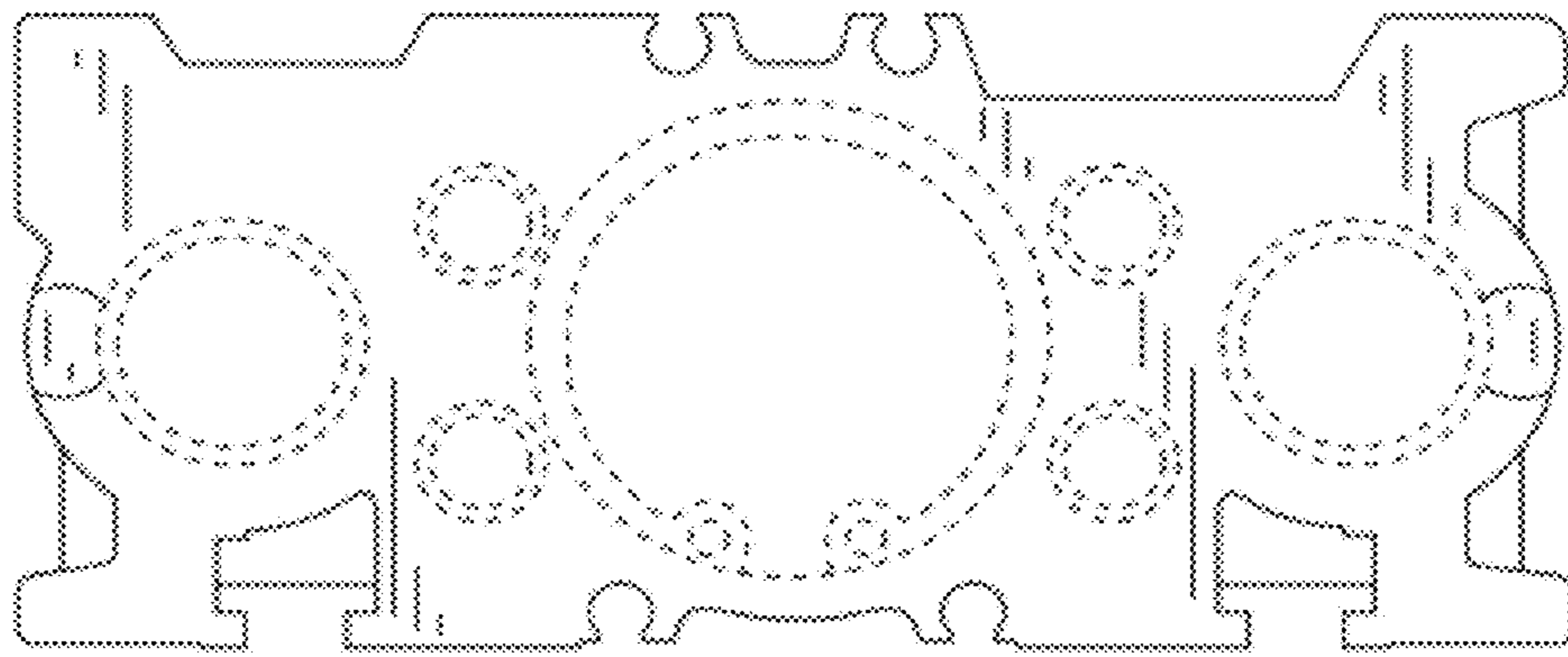

FIG. 4

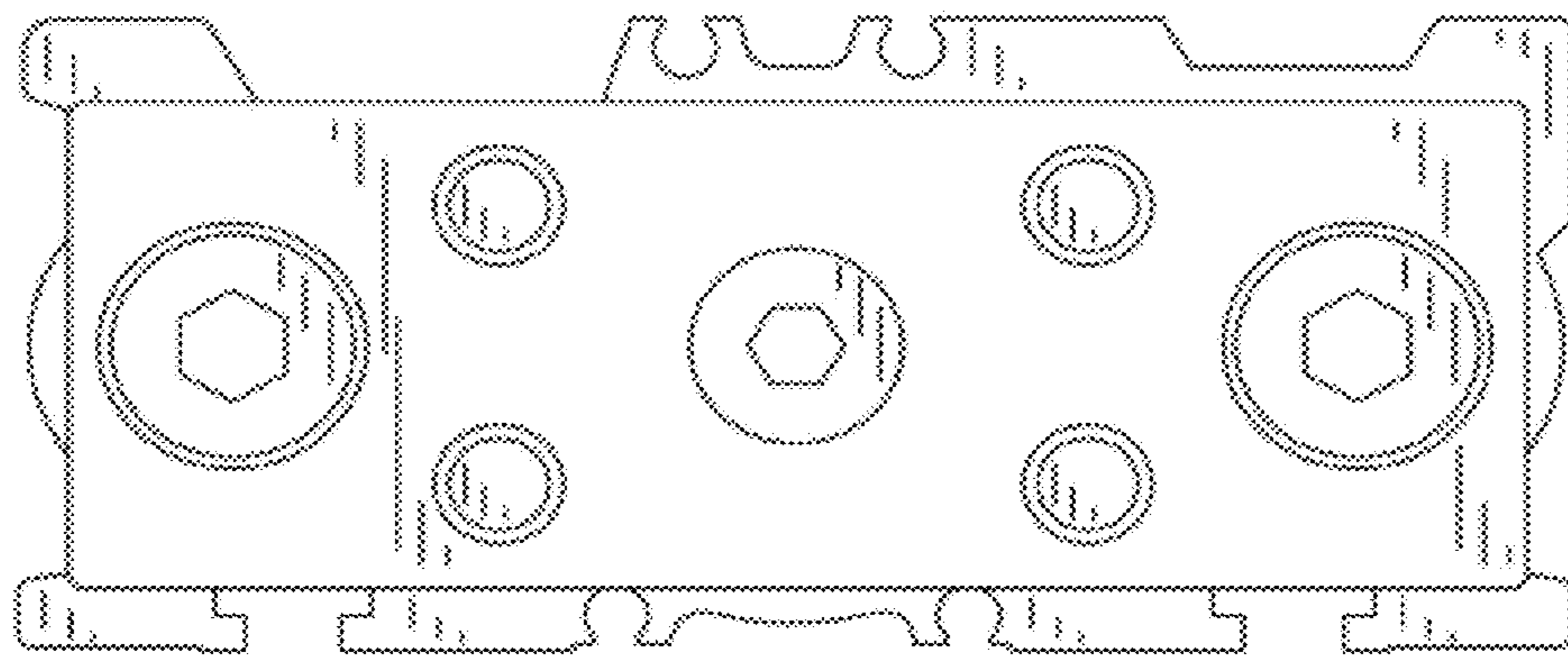

FIG. 5

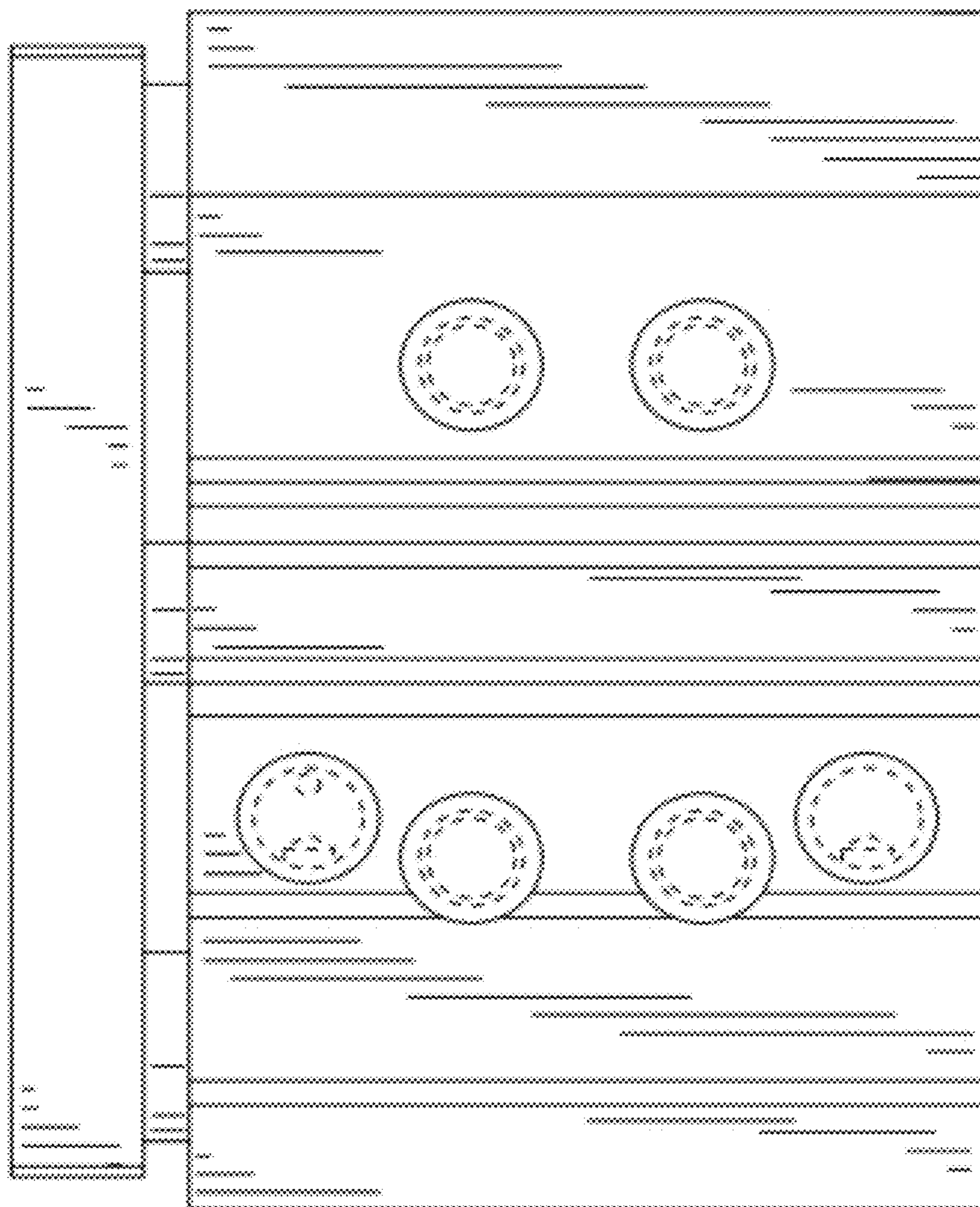

FIG. 6

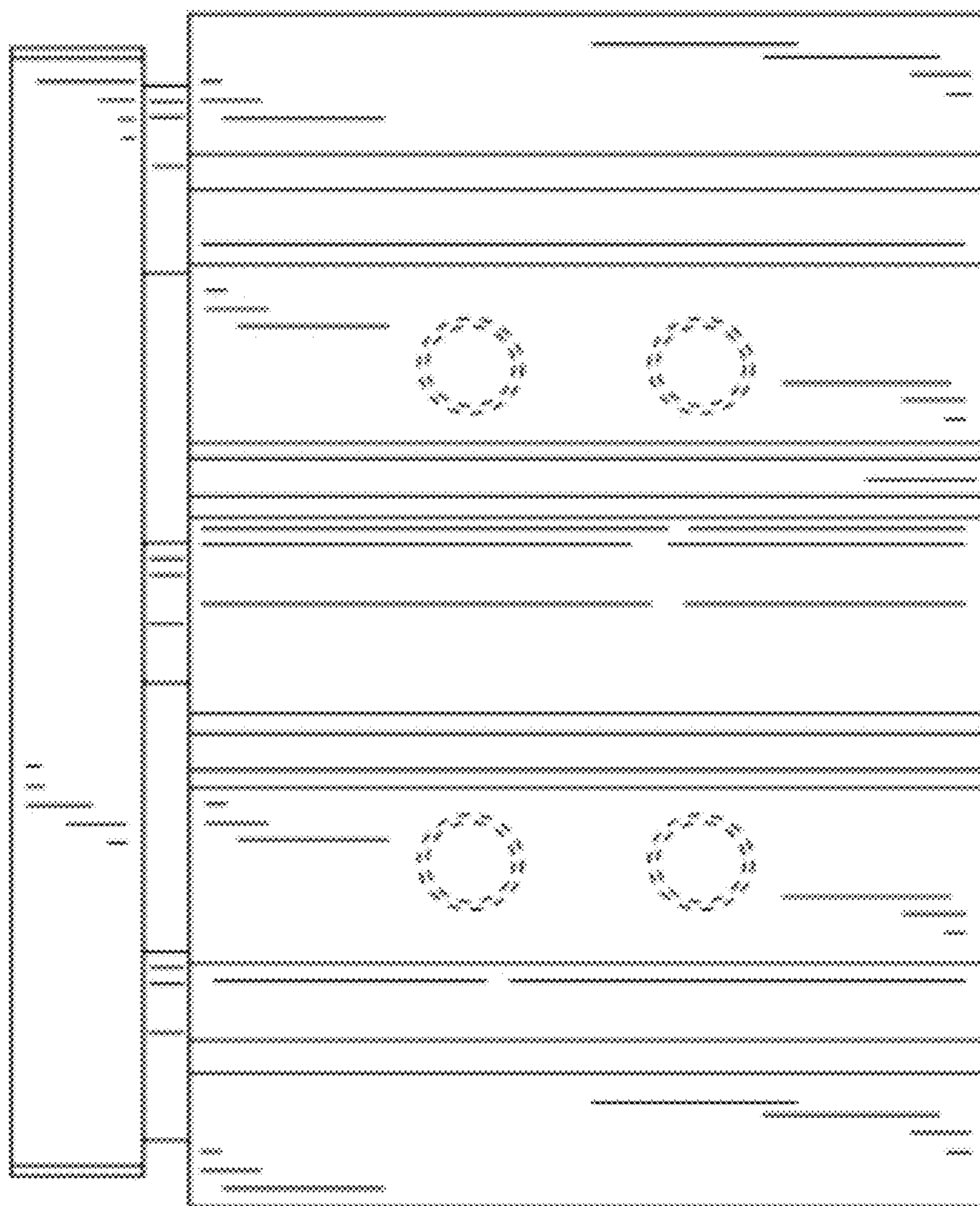

FIG. 7

