



US00D667531S

(12) **United States Design Patent**
Romero et al.

(10) **Patent No.:** **US D667,531 S**

(45) **Date of Patent:** **** Sep. 18, 2012**

(54) **SHOWERHEAD**

D565,702 S * 4/2008 Daunter et al. D23/223
D578,604 S * 10/2008 Wu et al. D23/223
D578,606 S * 10/2008 Wu et al. D23/223

(75) Inventors: **Emilie Williams Romero**, Chicago, IL
(US); **Michael Miller**, Fishers, IN (US)

* cited by examiner

(73) Assignee: **Masco Corporation of Indiana**,
Indianapolis, IN (US)

Primary Examiner — Robin V Webster

(74) *Attorney, Agent, or Firm* — Edgar A. Zarins; Nirav D.
Parikh; Lora J. Graentzdoerffer

(**) Term: **14 Years**

(21) Appl. No.: **29/403,988**

(57) **CLAIM**

The ornamental design for a showerhead, as shown and
described.

(22) Filed: **Oct. 13, 2011**

(51) **LOC (9) Cl.** **23-01**

(52) **U.S. Cl.** **D23/223**

(58) **Field of Classification Search** D23/213,
D23/223, 229, 230; 239/282, 283, 462, 394;
4/615

See application file for complete search history.

DESCRIPTION

FIG. 1 is a perspective view of a showerhead showing our new
design;

FIG. 2 is a top end view thereof;

FIG. 3 is a bottom end view thereof;

FIG. 4 is a rear view thereof;

FIG. 5 is a front elevational view thereof;

FIG. 6 is a right side view thereof; and,

FIG. 7 is a left side view thereof.

(56) **References Cited**

U.S. PATENT DOCUMENTS

D451,169 S * 11/2001 Lindholm et al. D23/223

D451,980 S * 12/2001 Lindholm et al. D23/223

1 Claim, 3 Drawing Sheets

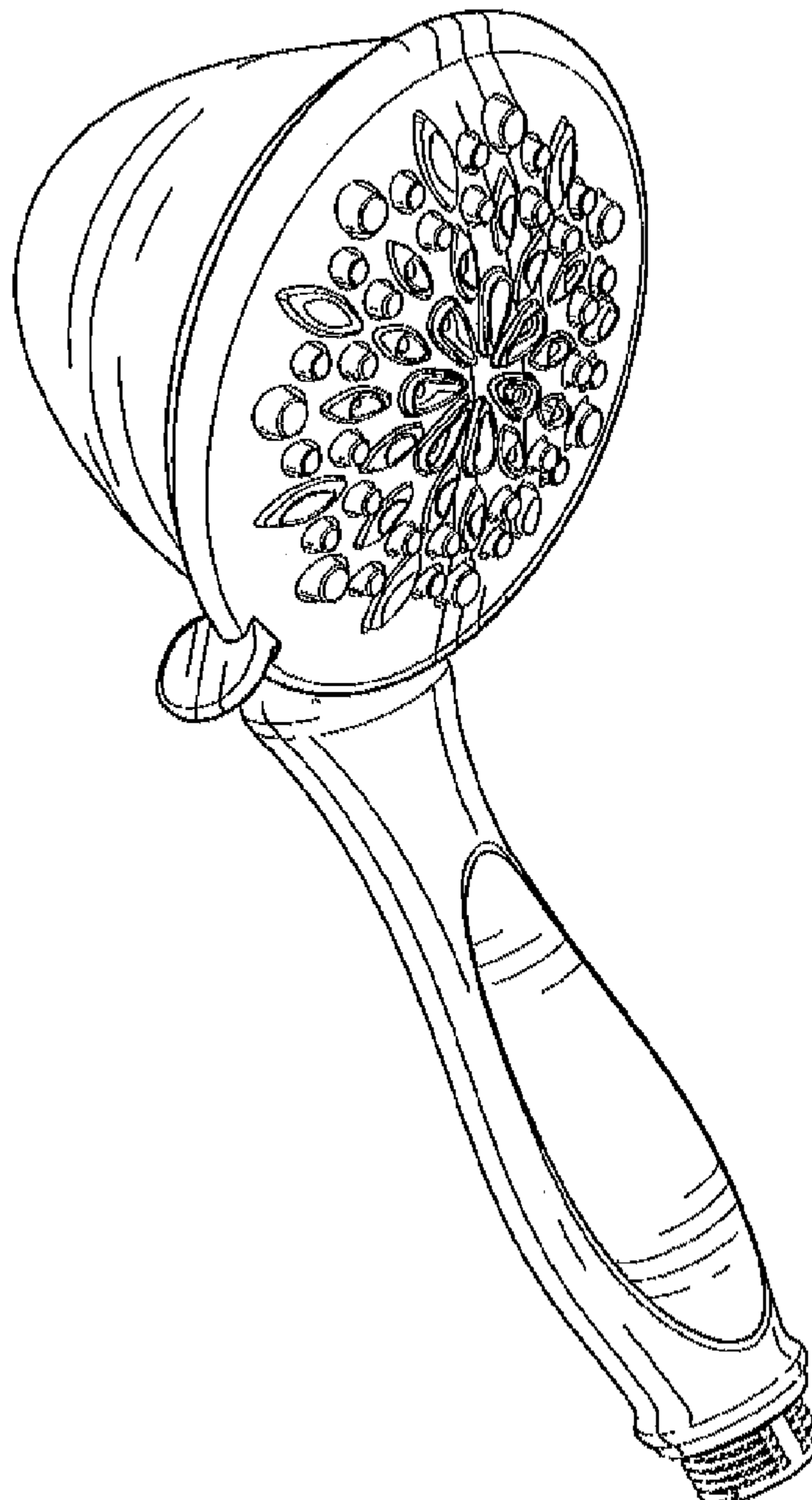

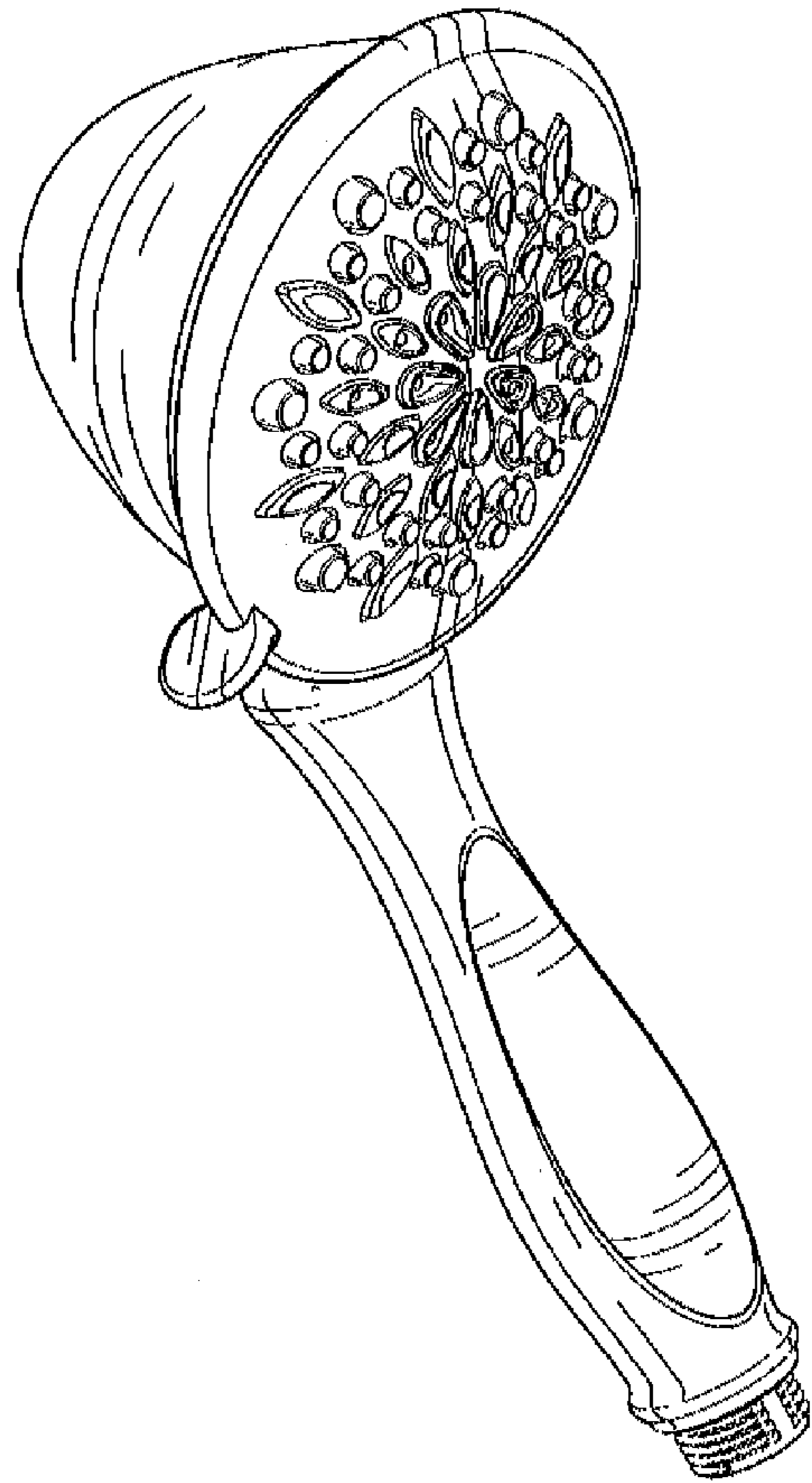

Fig-1

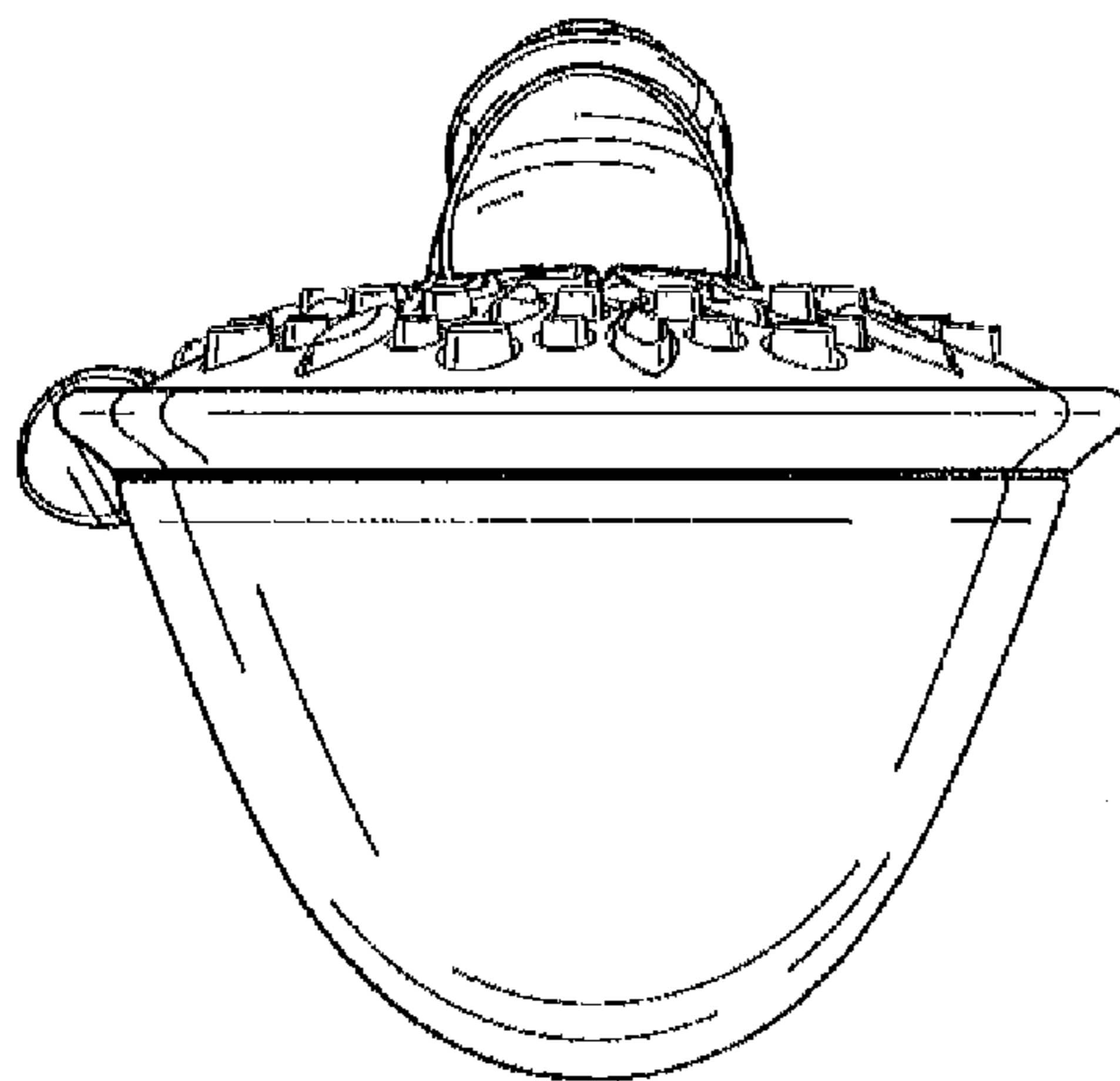

Fig-2

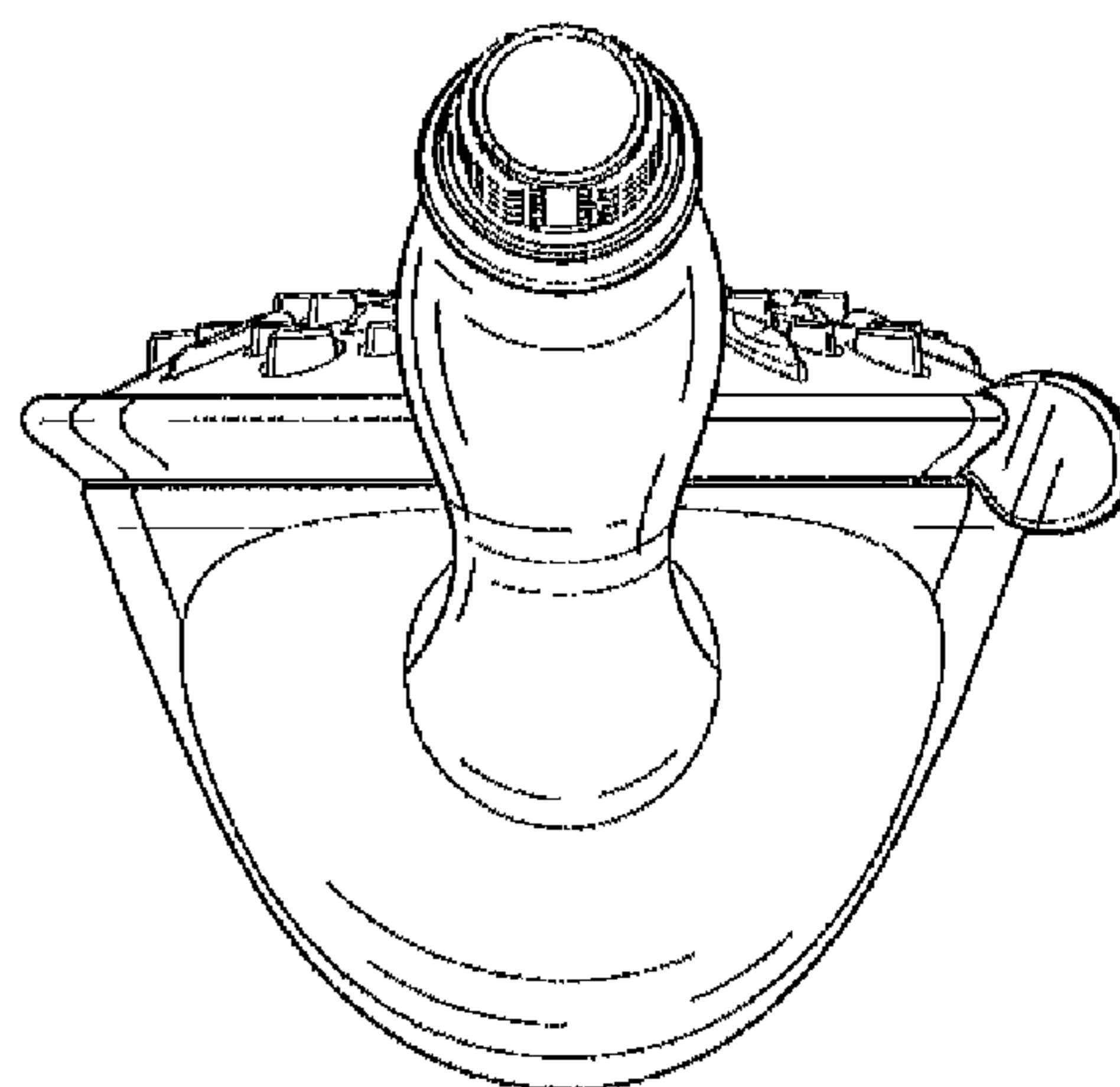

Fig-3

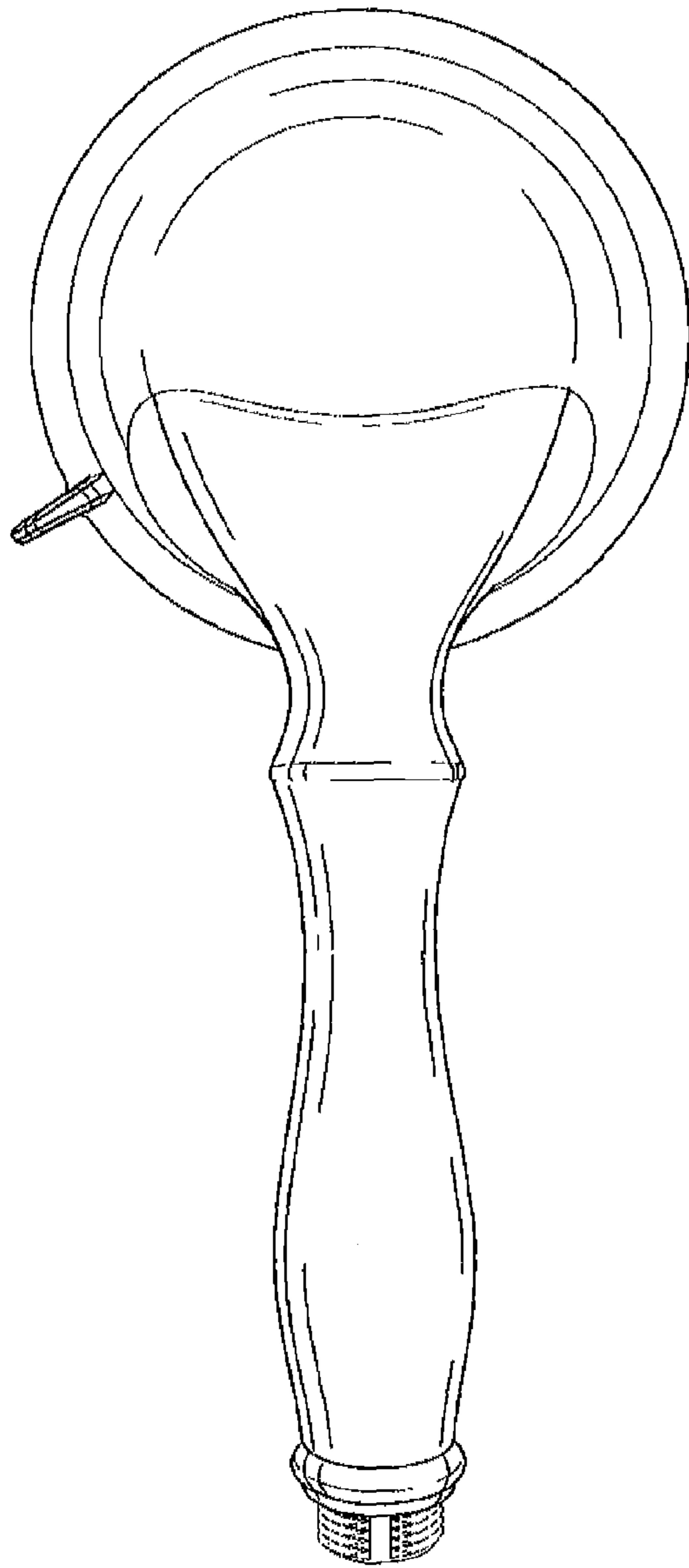

Fig-4

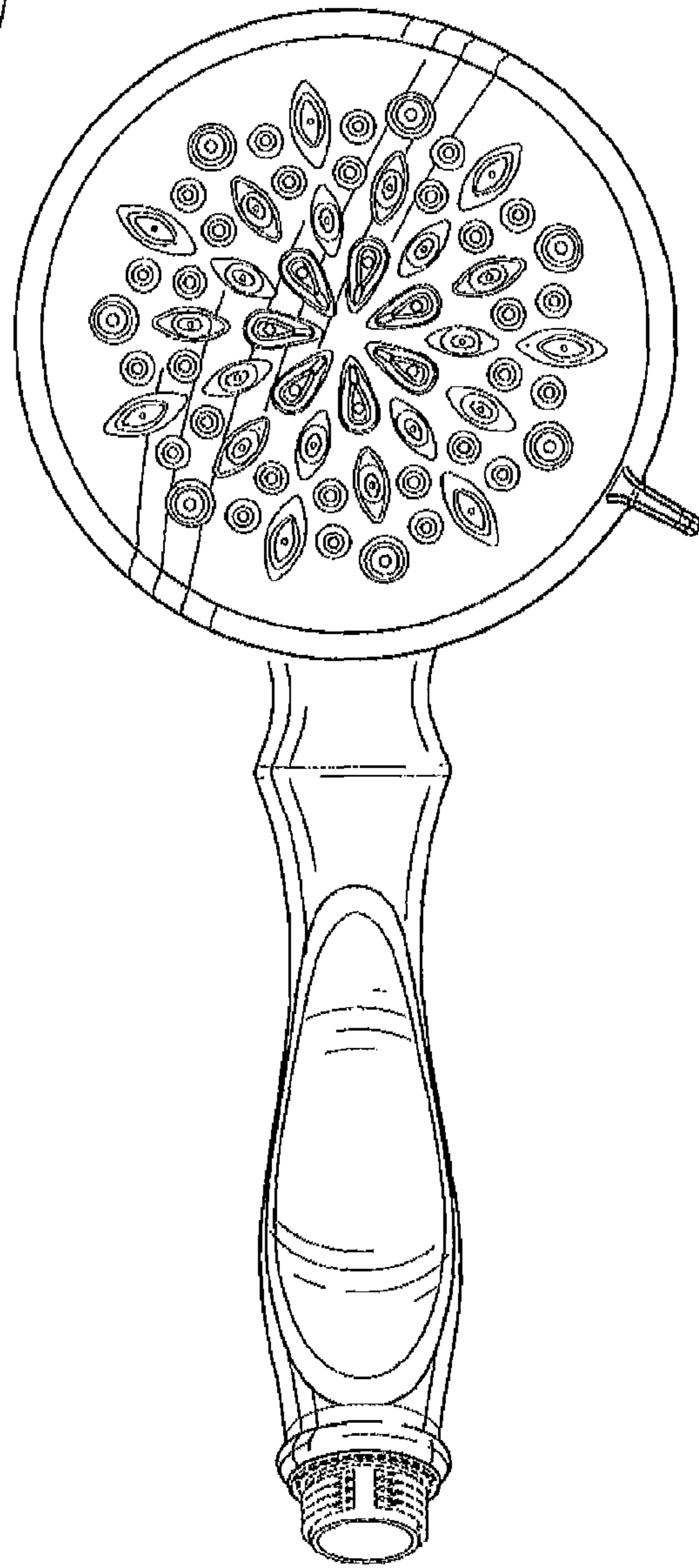

Fig-5

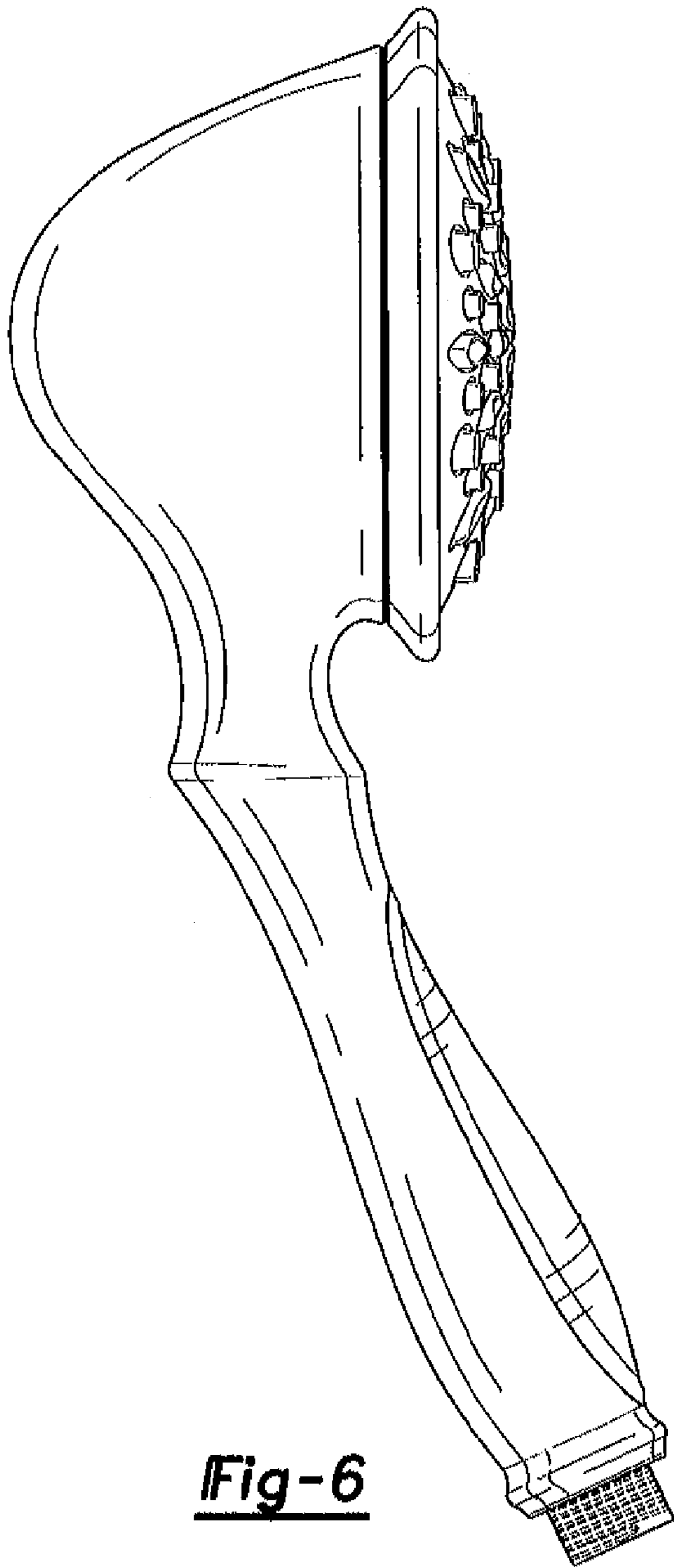

Fig-6

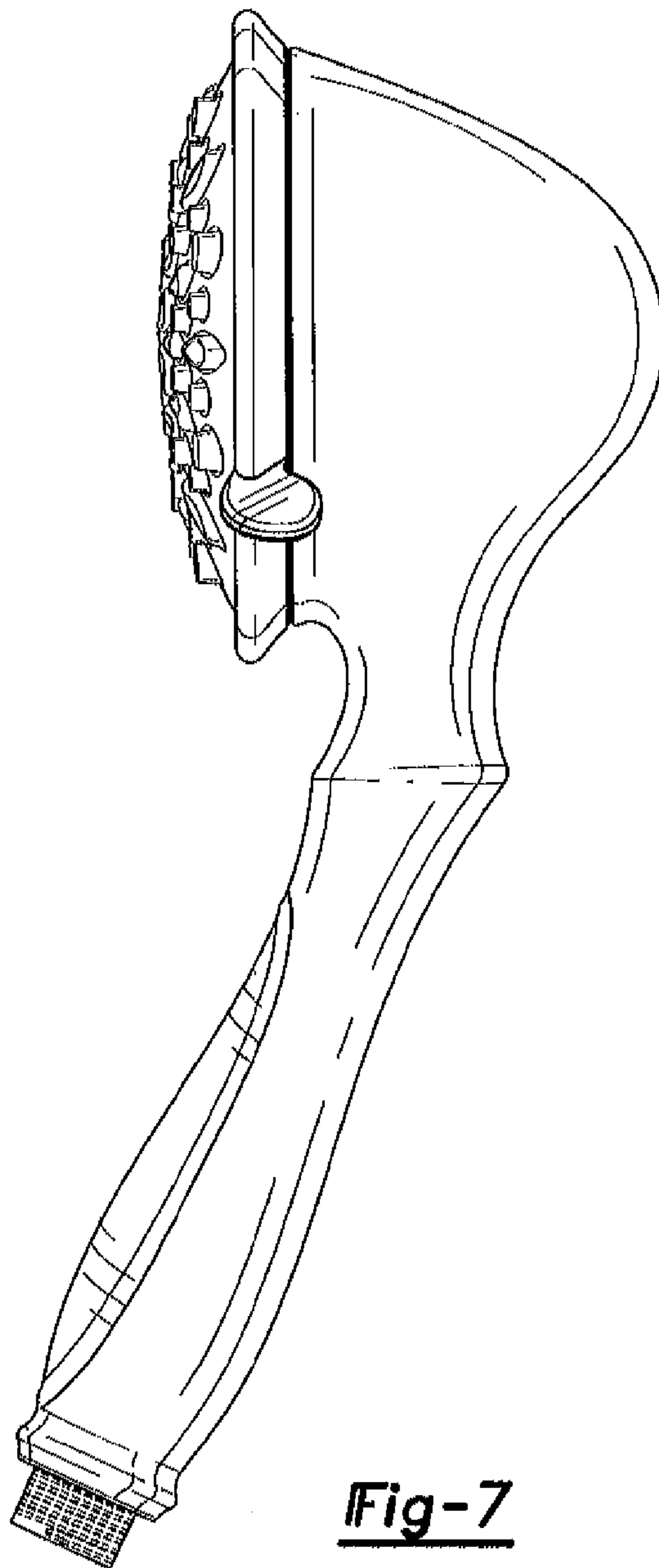

Fig-7