



US00D667507S

(12) **United States Design Patent**
Reyero

(10) **Patent No.:** **US D667,507 S**
(45) **Date of Patent:** **** Sep. 18, 2012**

(54) **SET OF BUILDING BLOCKS**

(75) Inventor: **Pilar Moran Reyero**, Madrid (ES)

(73) Assignee: **Taranto Estudios e Inversiones, S.L.**,
Madrid (ES)

(**) Term: **14 Years**

(21) Appl. No.: **29/359,571**

(22) Filed: **Apr. 13, 2010**

(30) **Foreign Application Priority Data**

Mar. 15, 2010 (EM) 001681438

(51) **LOC (9) Cl.** **21-01**

(52) **U.S. Cl.** **D21/484; D21/500**

(58) **Field of Classification Search** D21/484,
D21/845, 856, 489, 491, 493, 494, 500–502,
D21/504, 506, 507, 811, 826; D25/113;
D30/108; 482/35; 446/69, 85, 100–128,
446/487, 488

See application file for complete search history.

(56) **References Cited**

U.S. PATENT DOCUMENTS

2,131,349	A *	9/1938	Kreider, Jr.	446/69
3,485,494	A *	12/1969	Lieberman	482/35
3,561,757	A *	2/1971	Schillig	482/35
3,596,396	A *	8/1971	Thomson	446/487
3,773,329	A *	11/1973	Secter	273/153 R
3,822,569	A *	7/1974	Lautrup-Larsen	446/85
4,875,681	A *	10/1989	Ofir	273/155
D429,037	S *	8/2000	Calhoun	D30/108
2002/0115374	A1 *	8/2002	Lavender	446/85

* cited by examiner

Primary Examiner — Cynthia M Chin

(74) *Attorney, Agent, or Firm* — Greenblum & Bernstein,
P.L.C.

(57) **CLAIM**

I claim the ornamental design for a set of building blocks, as shown and described.

DESCRIPTION

FIG. 1 shows a perspective view of a single block of a set of blocks;

FIG. 2 shows a perspective view of another single block of the set of blocks;

FIG. 3 shows a perspective view of another single block of the set of blocks having an opening on the right-hand side and a cover;

FIG. 4 shows a perspective view of another single block of the set of blocks having an opening on the front side and a cover;

FIG. 5 shows a perspective view of a single block of a set of blocks having an opening on the front side;

FIG. 6 shows a perspective view of another single block of the set of blocks having an opening on the front side;

FIG. 7 shows a perspective view of another single block of the set of blocks having an opening on the front side and a cover;

FIG. 8 shows a perspective view of another single block of the set of blocks;

FIG. 9 shows a front side view of the block shown in FIG. 1;

FIG. 10 shows a front side view of the block shown in FIG. 2;

FIG. 11 shows a front side view of block shown in FIG. 3 with the cover in place;

FIG. 12 shows a front side view of block shown in FIG. 4 without the cover in place;

FIG. 13 shows a front side view of the block shown in FIG. 4 with the cover in place;

FIG. 14 shows a front side view of the block shown in FIG. 5;

FIG. 15 shows a front side view of the block shown in FIG. 6;

FIG. 16 shows a front side view of the block shown in FIG. 7 without the cover in place;

FIG. 17 shows a front side view of the block shown in FIG. 7 with the cover in place;

FIG. 18 shows a front side view of the block shown in FIG. 8;

FIG. 19 shows a bottom side view of the block shown in FIG. 9;

FIG. 20 shows a bottom side view of the block shown in FIG. 10;

FIG. 21 shows a bottom side view of the block shown in FIG. 11;

FIG. 22 shows a bottom side view of the block shown in FIG. 12;

FIG. 23 shows a bottom side view of the block shown in FIG. 13;

FIG. 24 shows a bottom side view of the block shown in FIG. 14;

FIG. 25 shows a bottom side view of the block shown in FIG. 15;

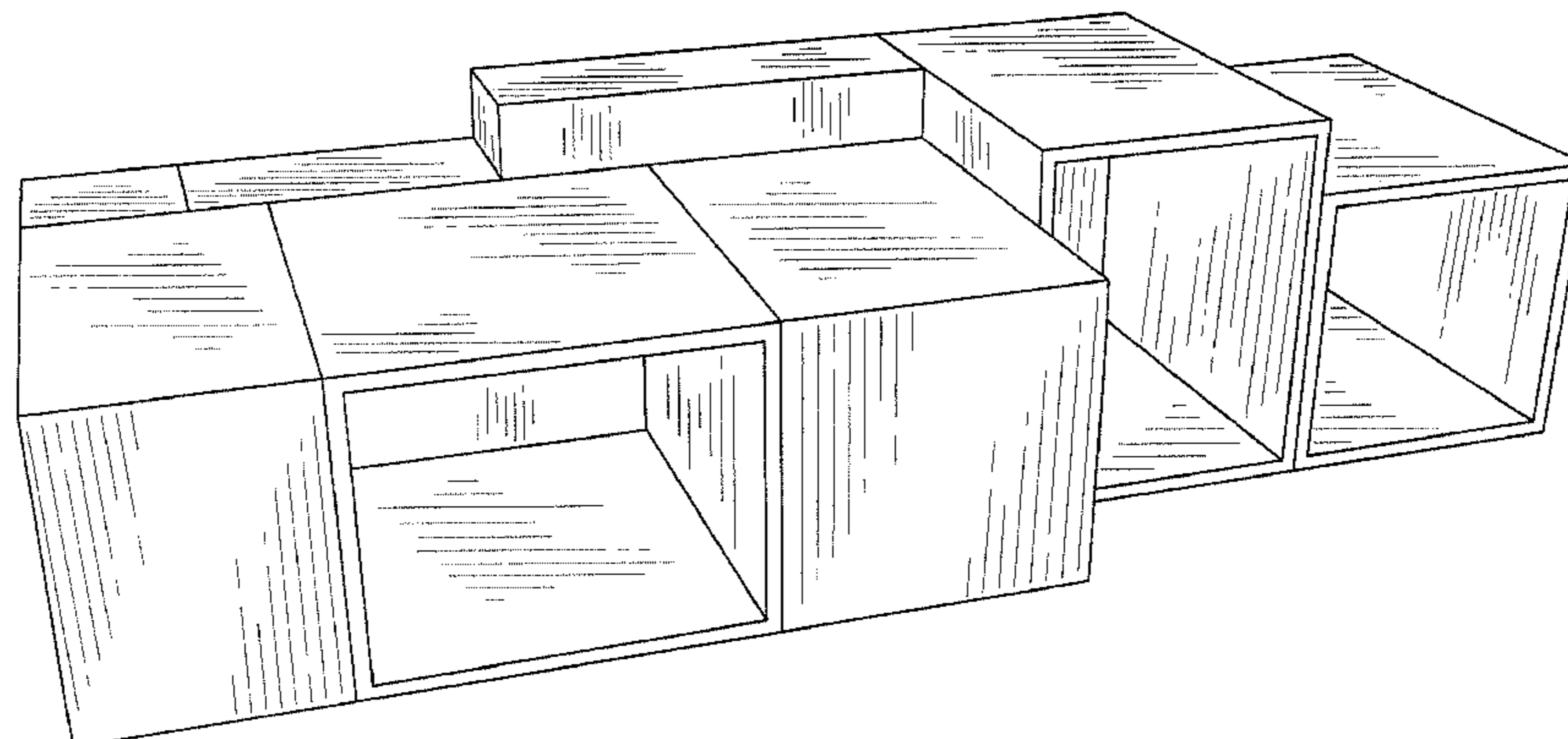

FIG. **26** shows a bottom side view of the block shown in FIG. **16**;

FIG. **27** shows a bottom side view of the block shown in FIG. **17**;

FIG. **28** shows a bottom side view of the block shown in FIG. **18**;

FIG. **29** shows an example of a structure using the blocks of the set shown in FIGS. **1-8**;

FIG. **30** shows another example of a structure using the blocks of the set shown in FIGS. **1-8**;

FIG. **31** shows another example of a structure using the blocks of the set shown in FIGS. **1-8**;

FIG. **32** shows another example of a structure using some of the blocks of the set shown in FIGS. **1-8**;

FIG. **33** shows another example of a structure using the blocks of the set shown in FIGS. **1-8**;

FIG. **34** shows another example of a structure using some of the blocks of the set shown in FIGS. **1-8**;

FIG. **35** shows another example of a structure using some of the blocks of the set shown in FIGS. **1-8**;

FIG. **36** shows another example of a structure using some of the blocks of the set shown in FIGS. **1-8**;

FIG. **37** shows another example of a structure using the blocks of the set shown in FIGS. **1-8**;

FIG. **38** shows another example of a structure using the blocks of the set shown in FIGS. **1-8**; and,

FIG. **39** shows another example of a structure using the blocks of the set shown in FIGS. **1-8**.

Individual blocks of the set of building blocks are shown separately in FIGS. **1-28** for the ease and clarity of illustration.

1 Claim, 15 Drawing Sheets

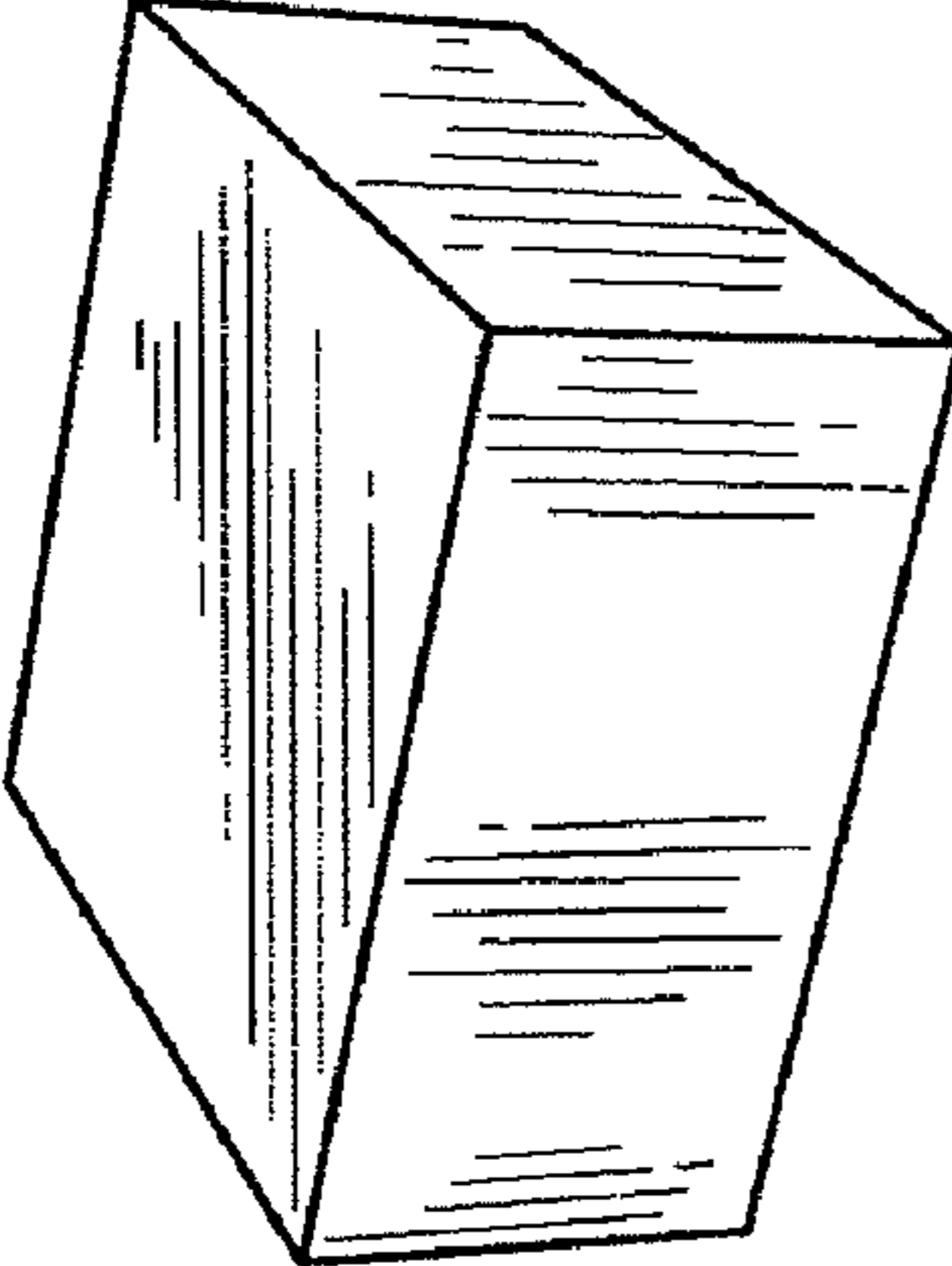

FIG. 1

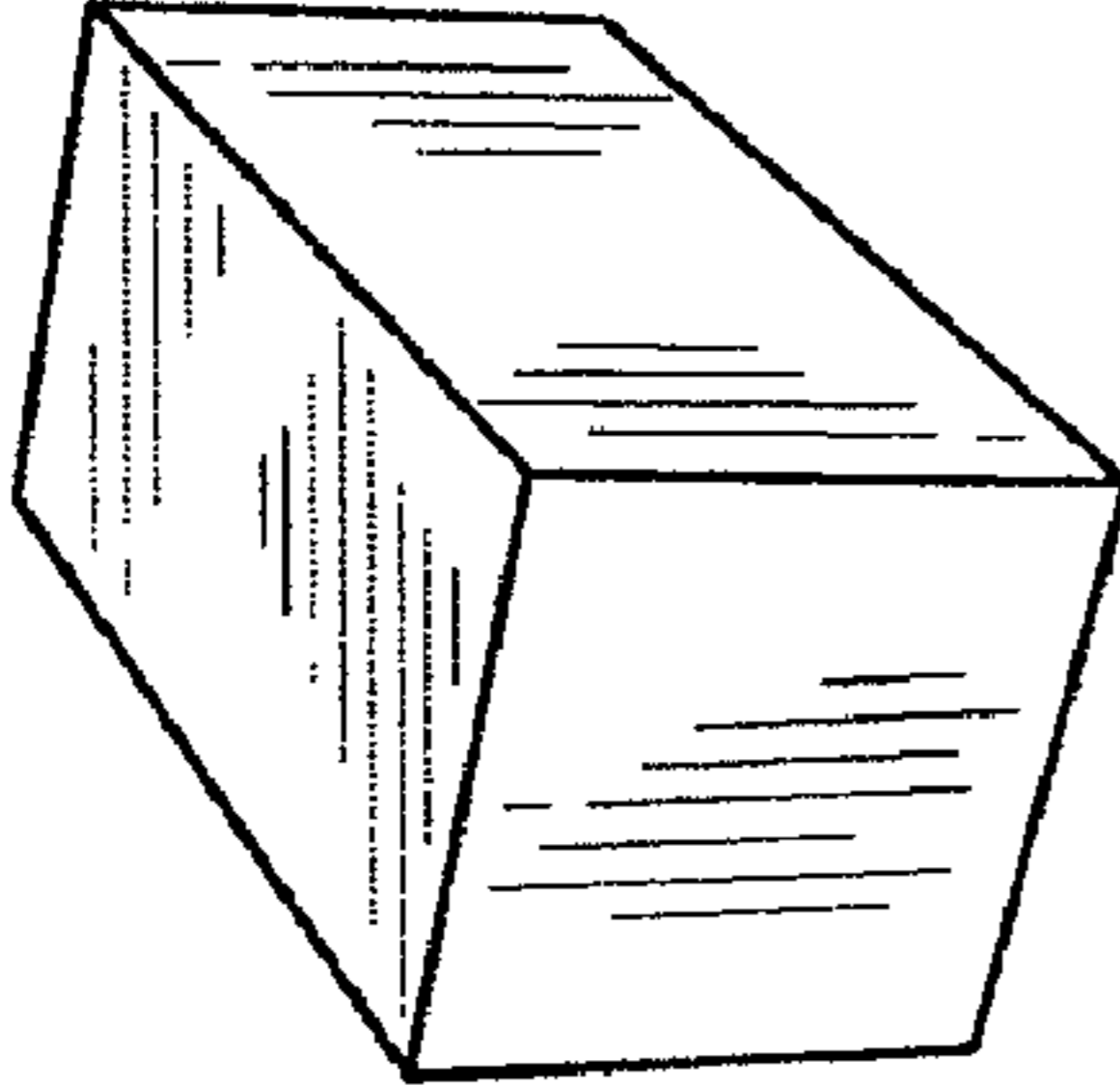

FIG. 2

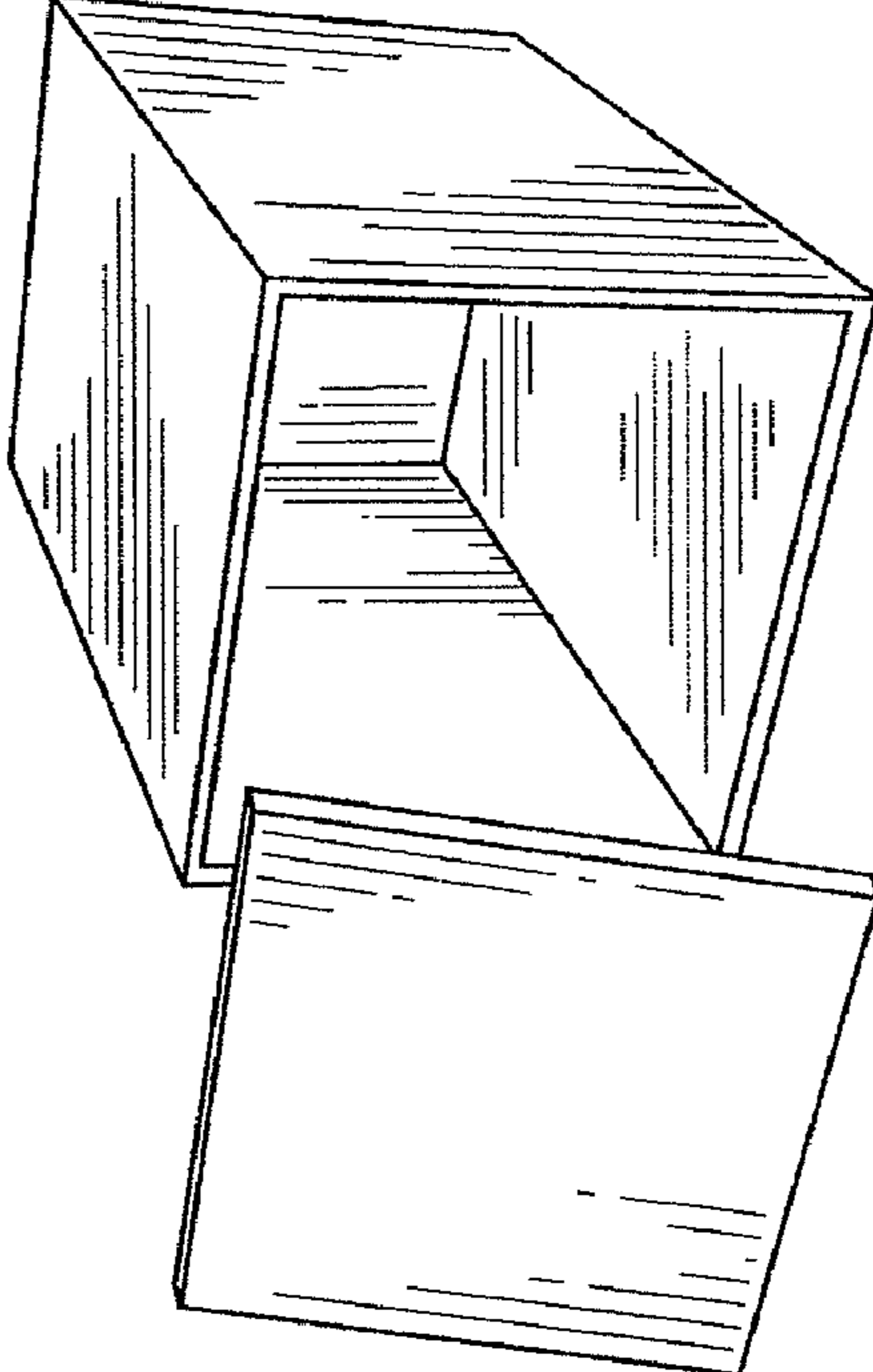

FIG. 3

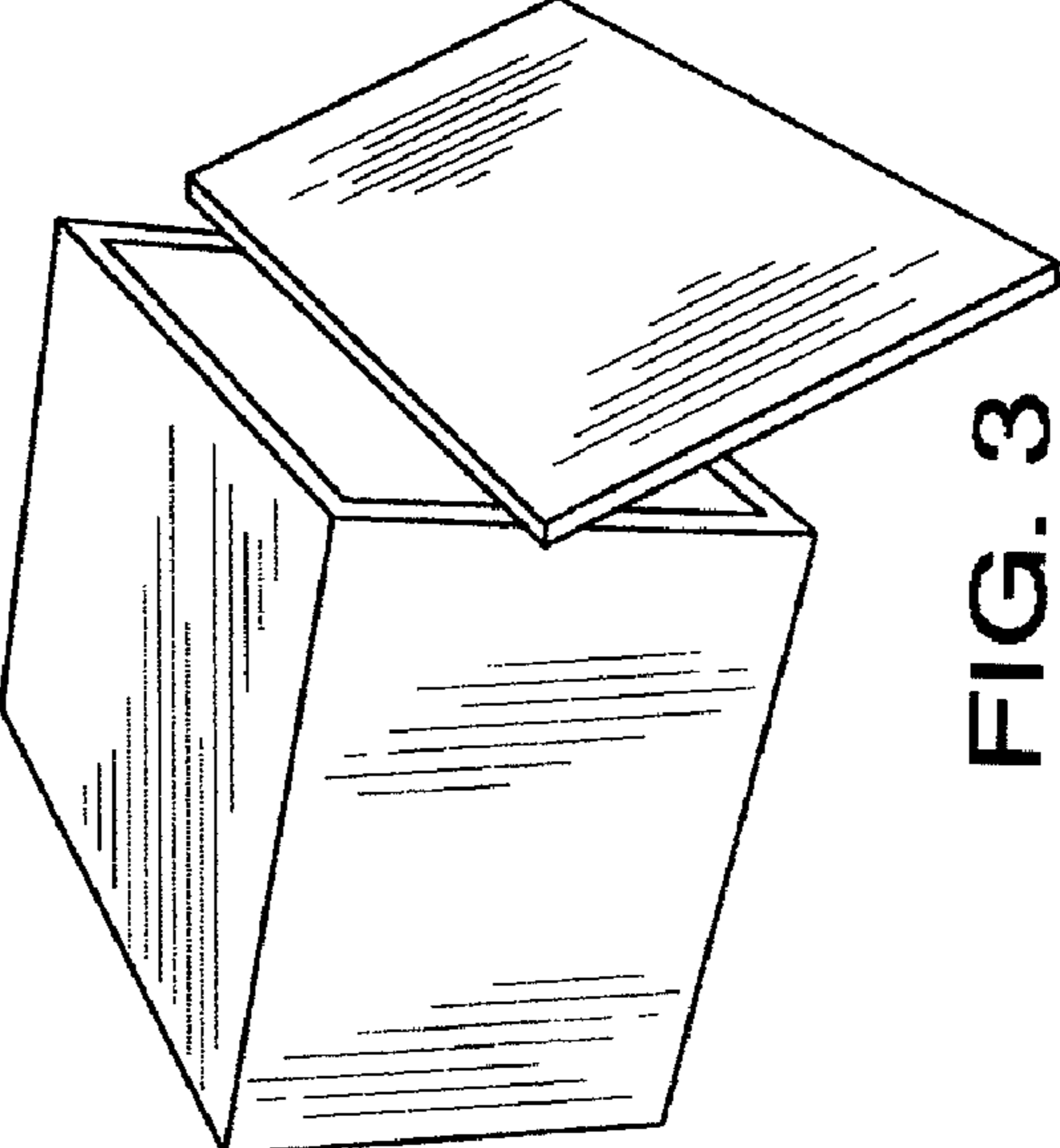

FIG. 4

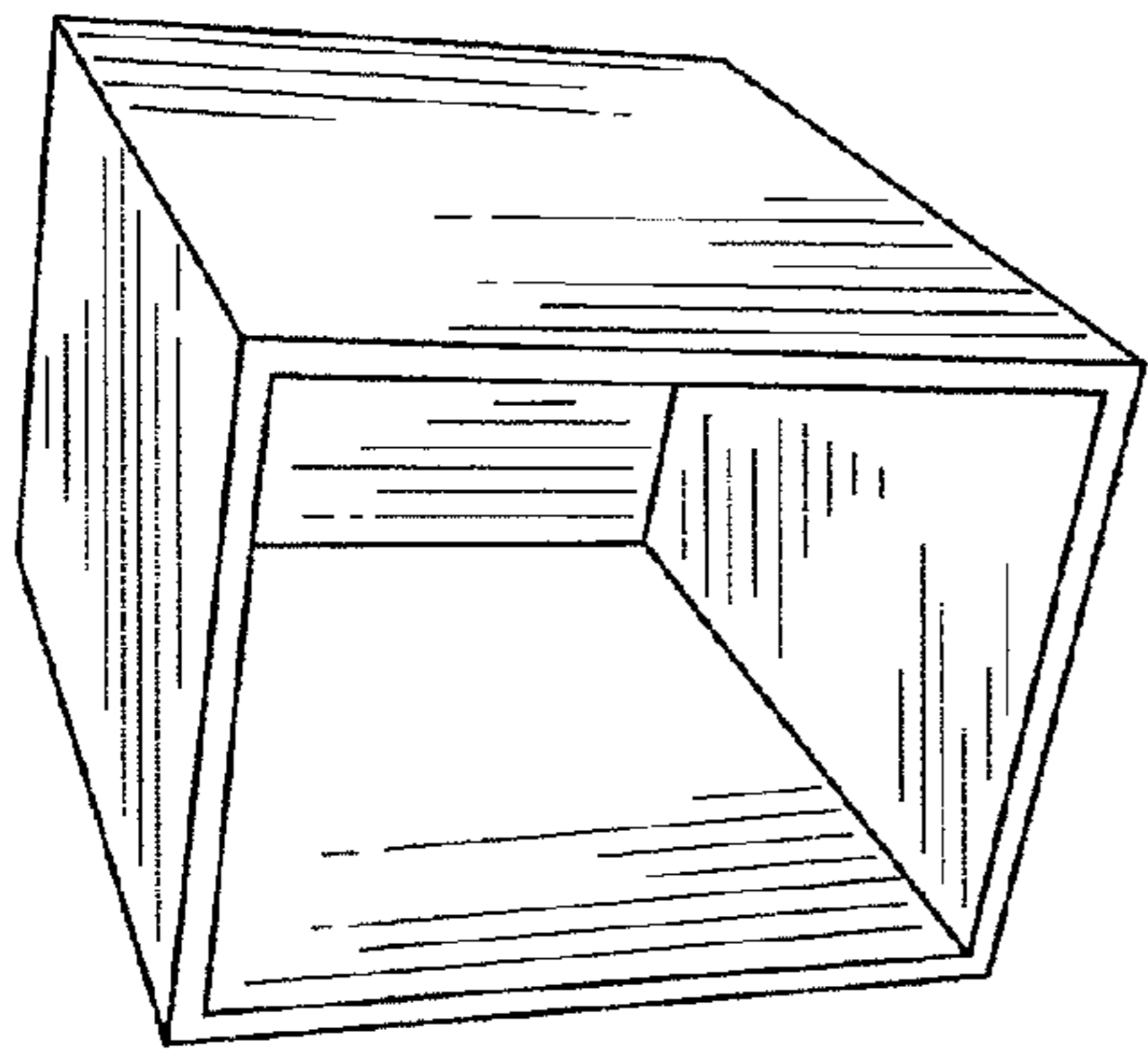

FIG. 6

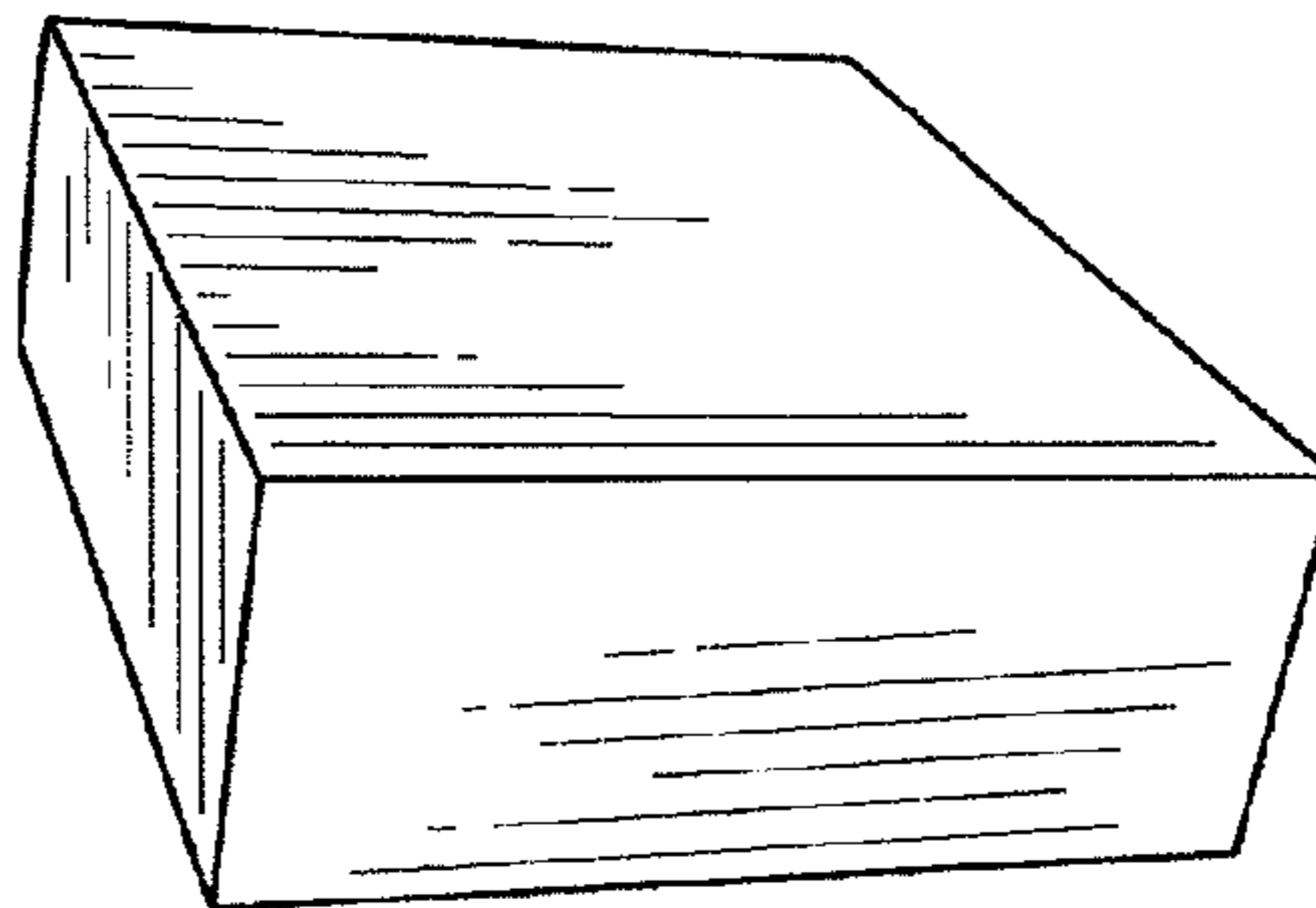

FIG. 8

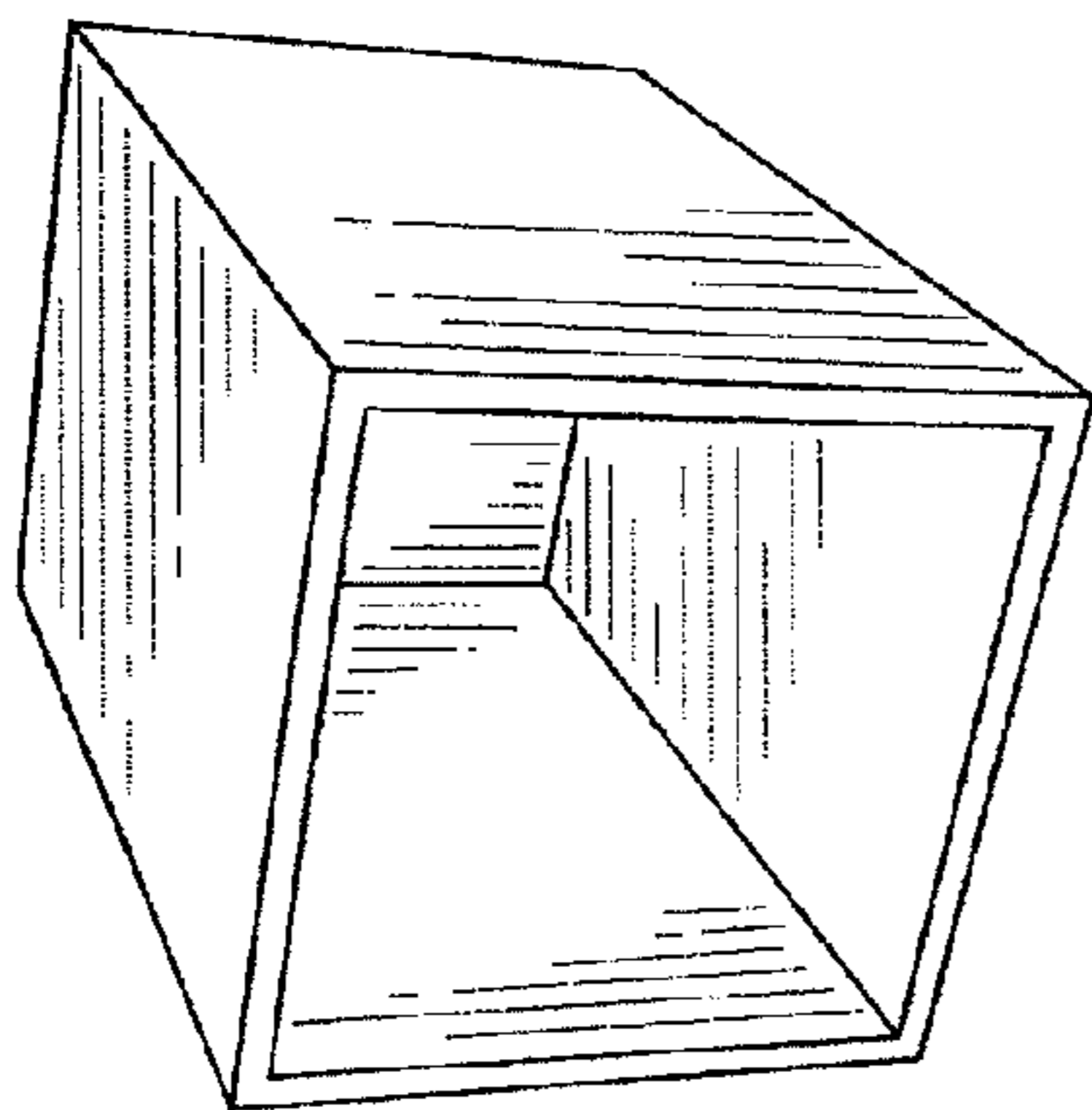

FIG. 5

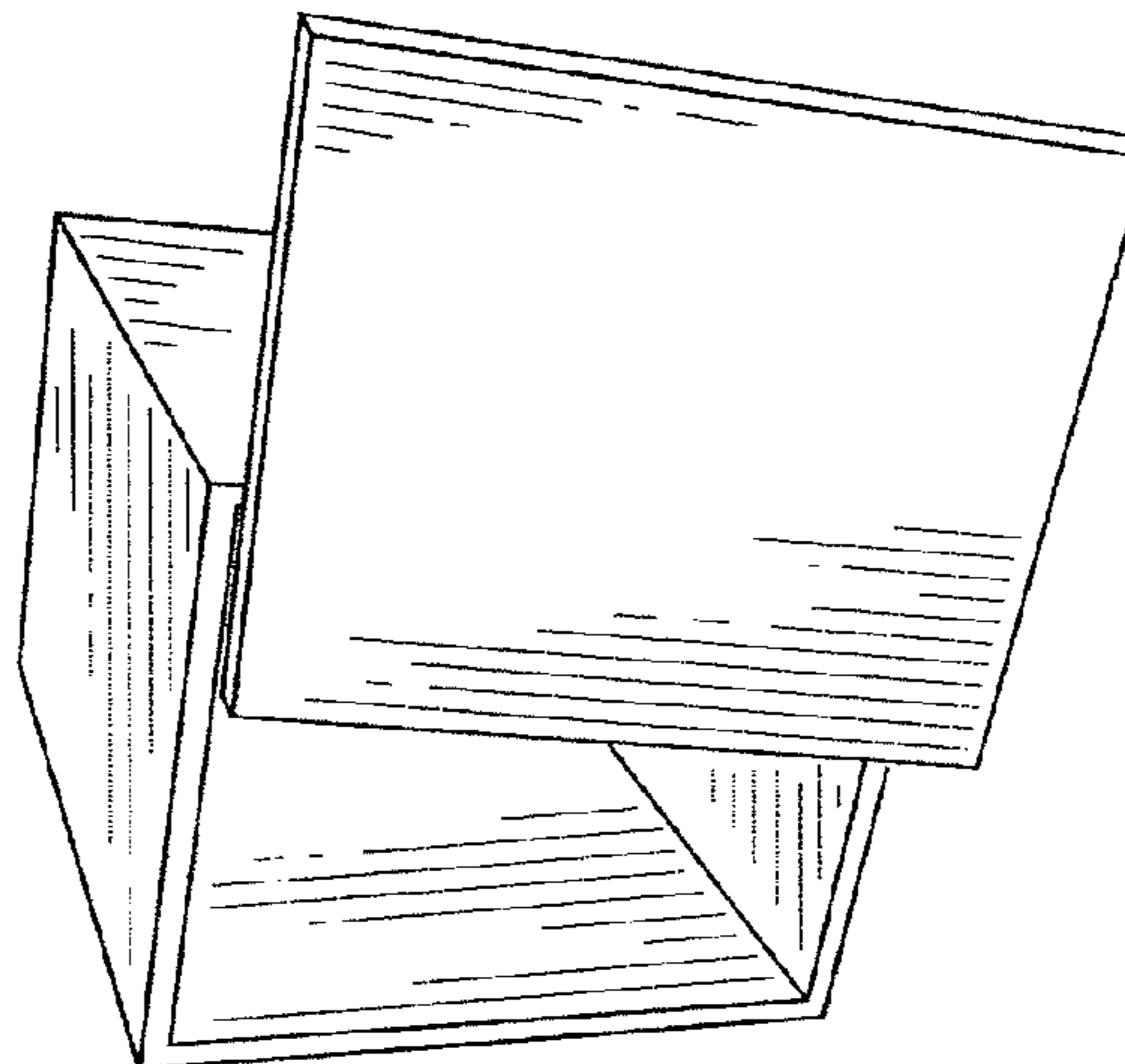

FIG. 7

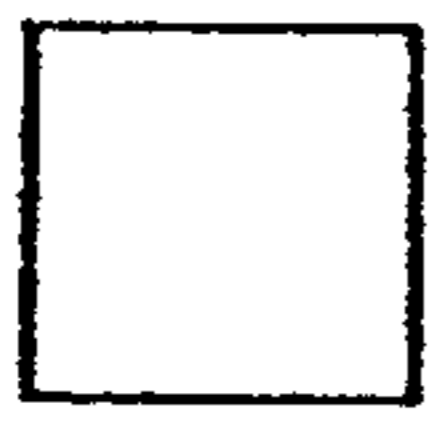

FIG. 9

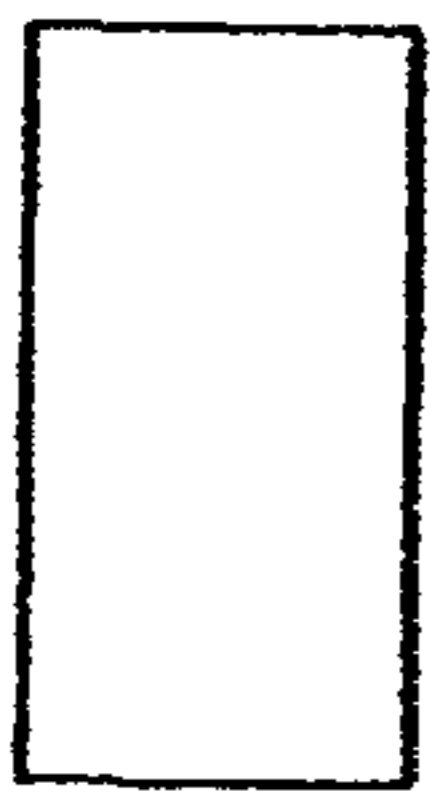

FIG. 10

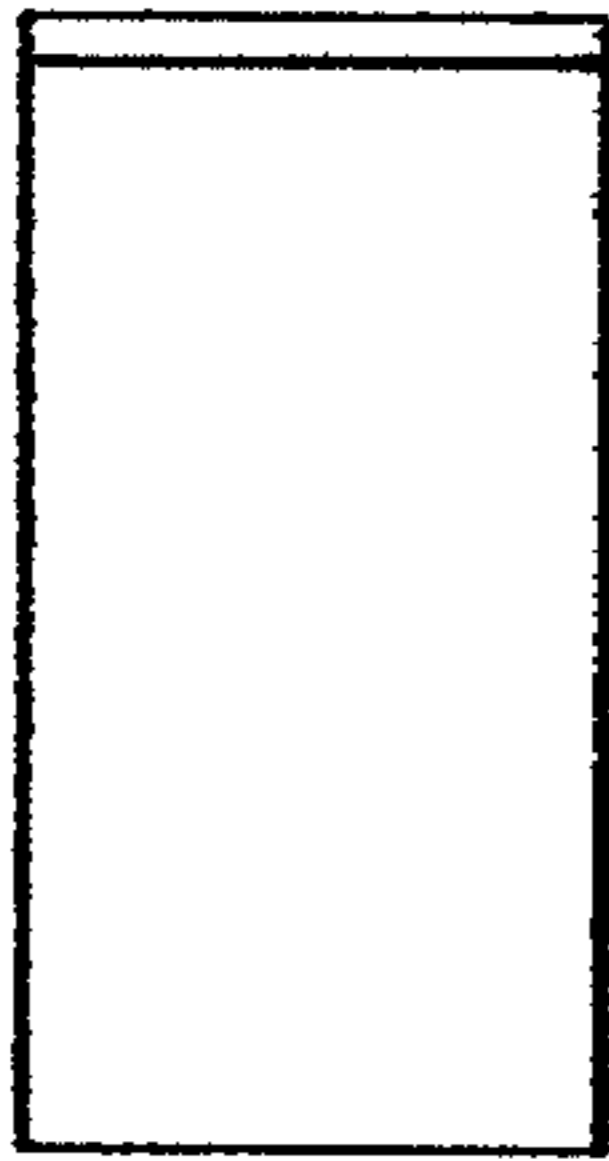

FIG. 11

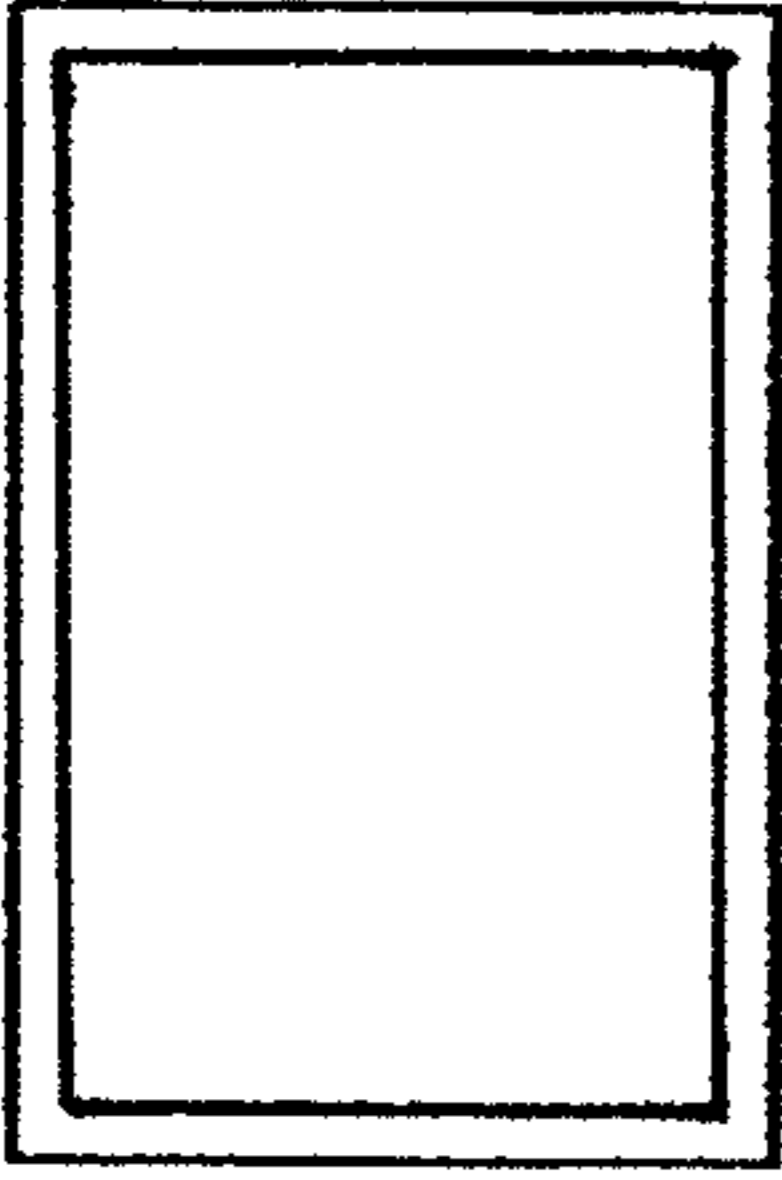

FIG. 12

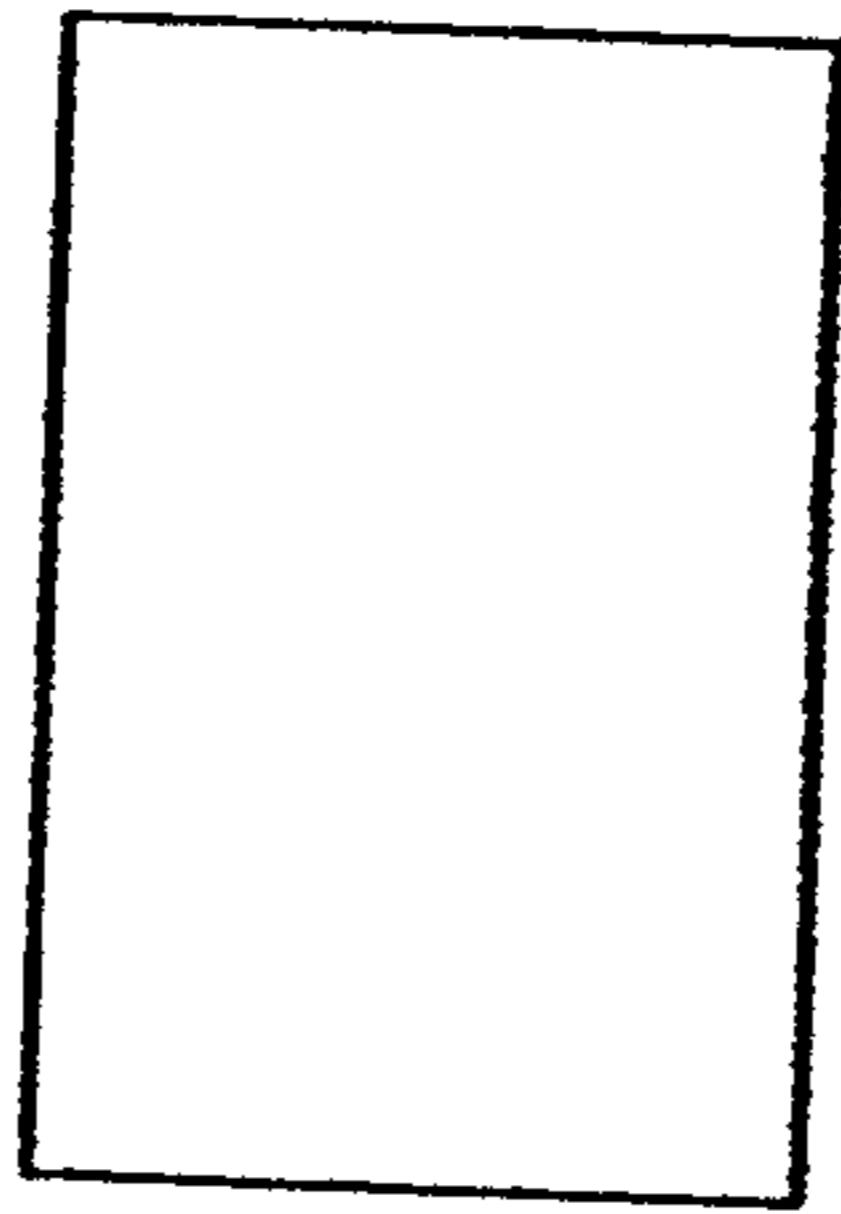

FIG. 13

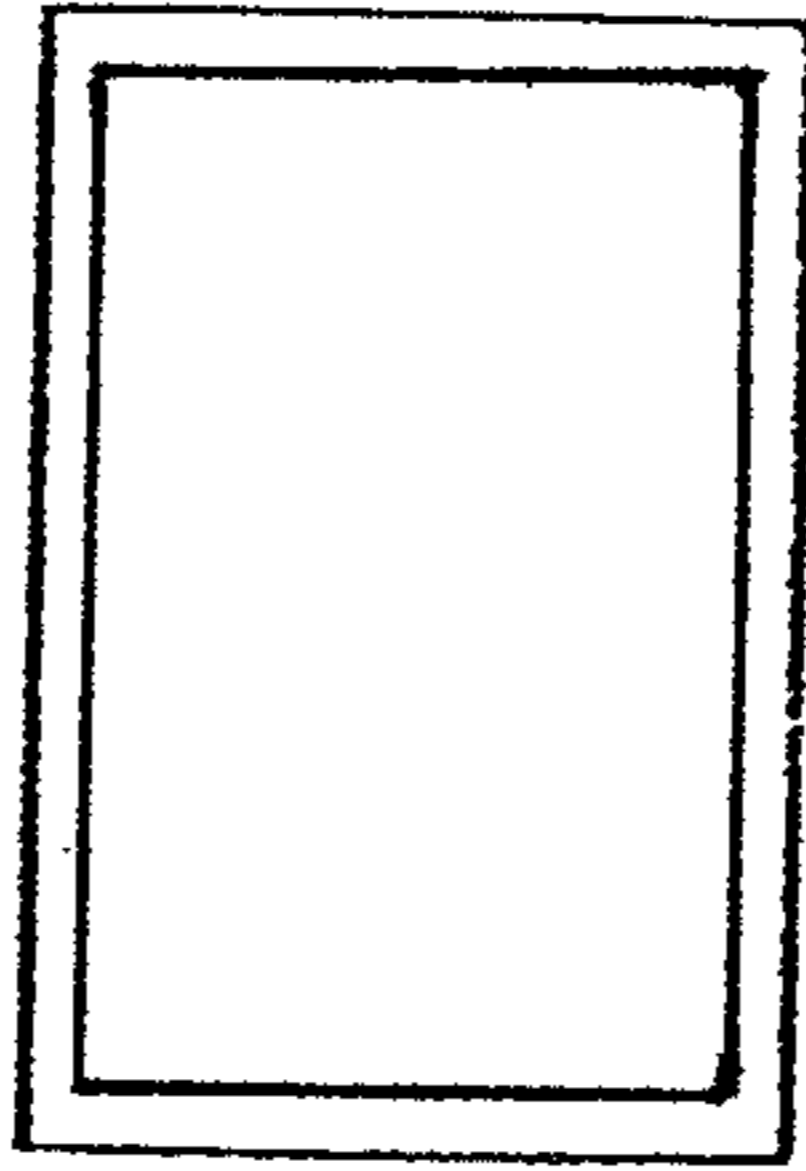

FIG. 14

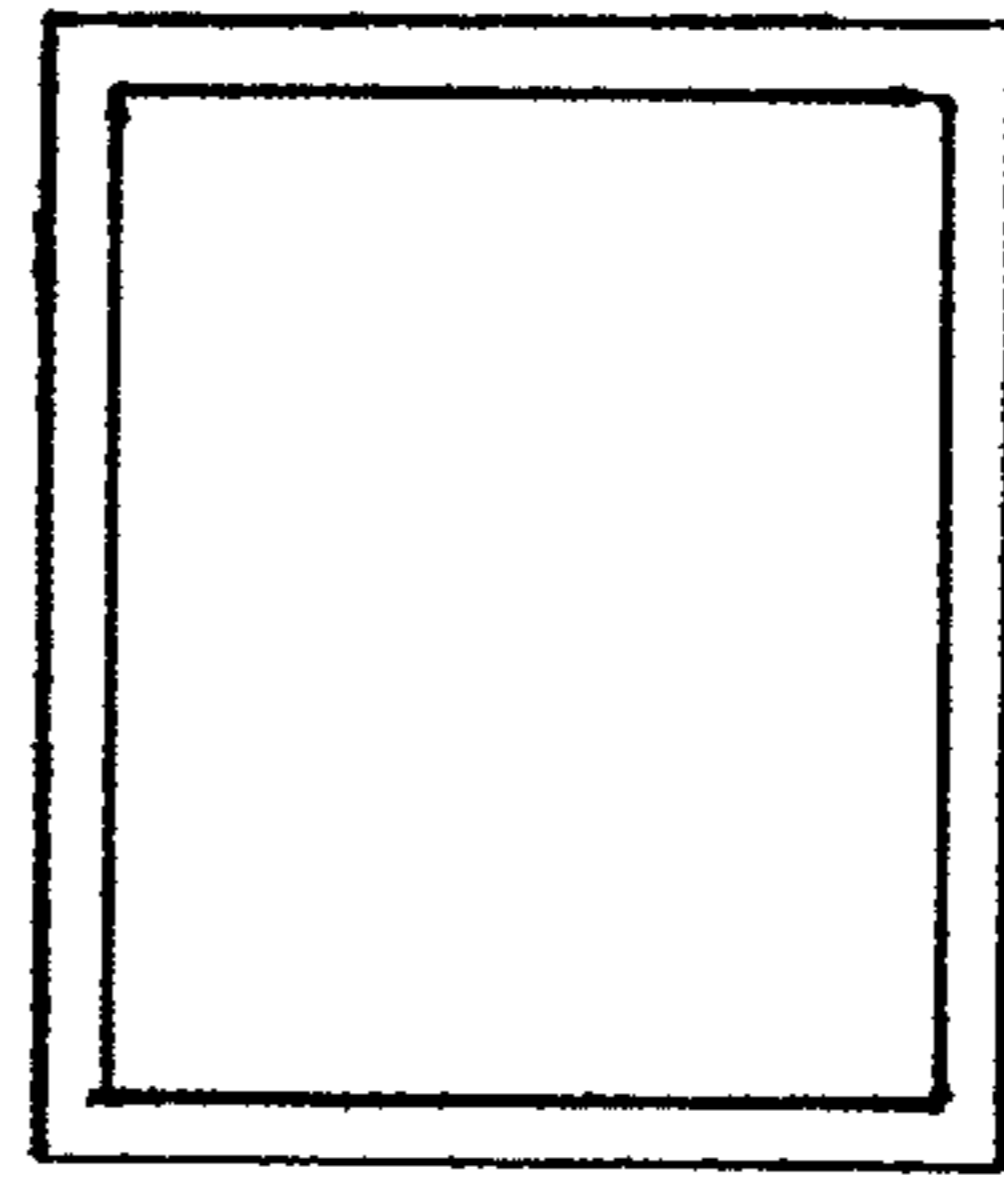

FIG. 15

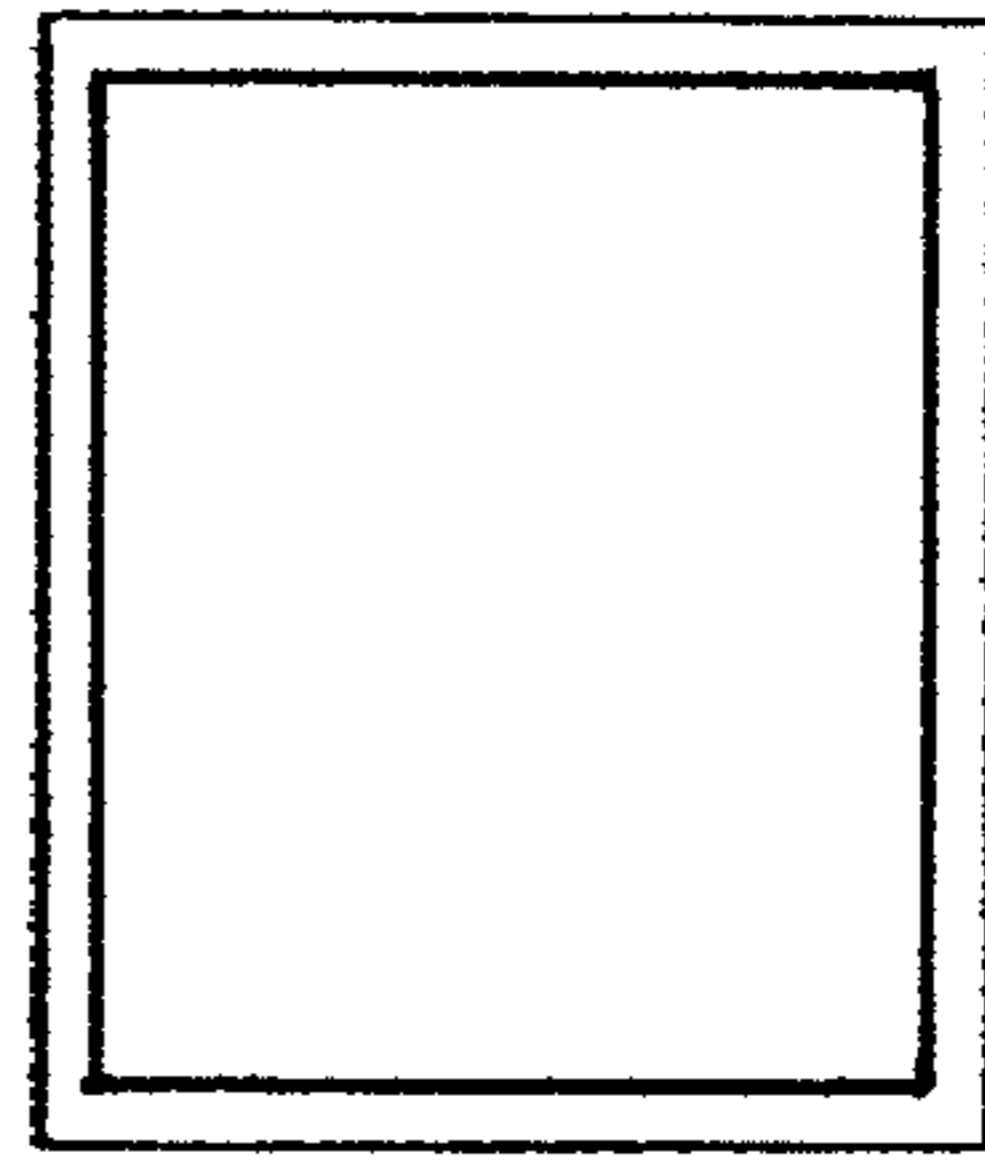

FIG. 16

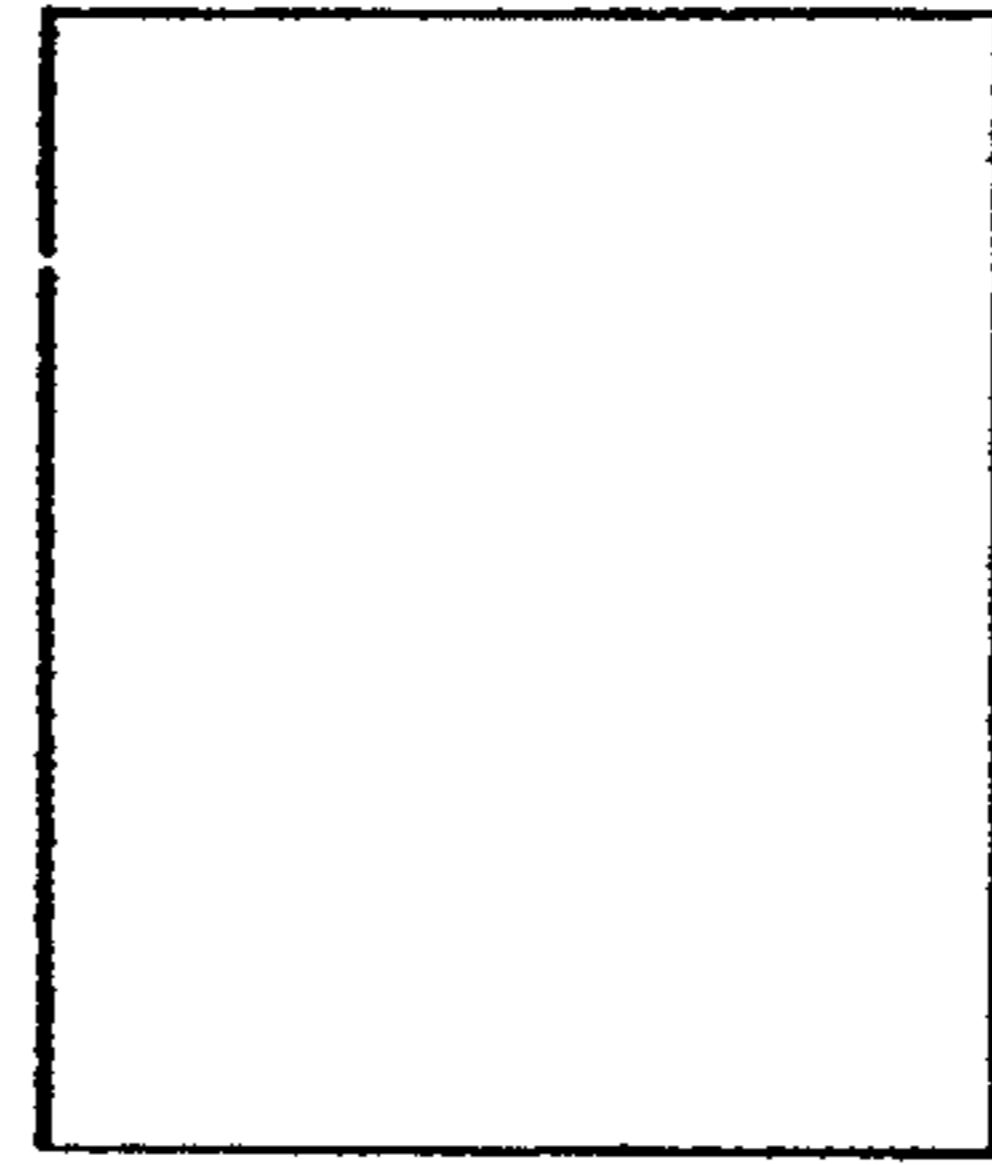

FIG. 17



FIG. 18

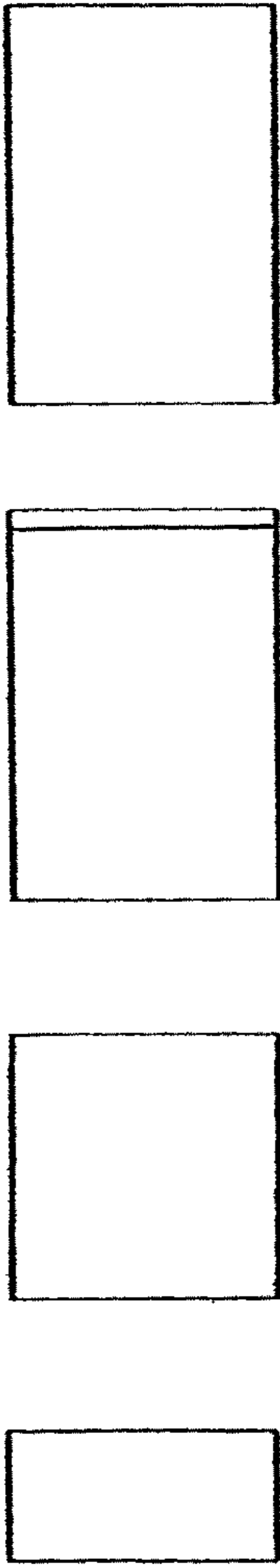

FIG. 19 FIG. 20 FIG. 21 FIG. 22

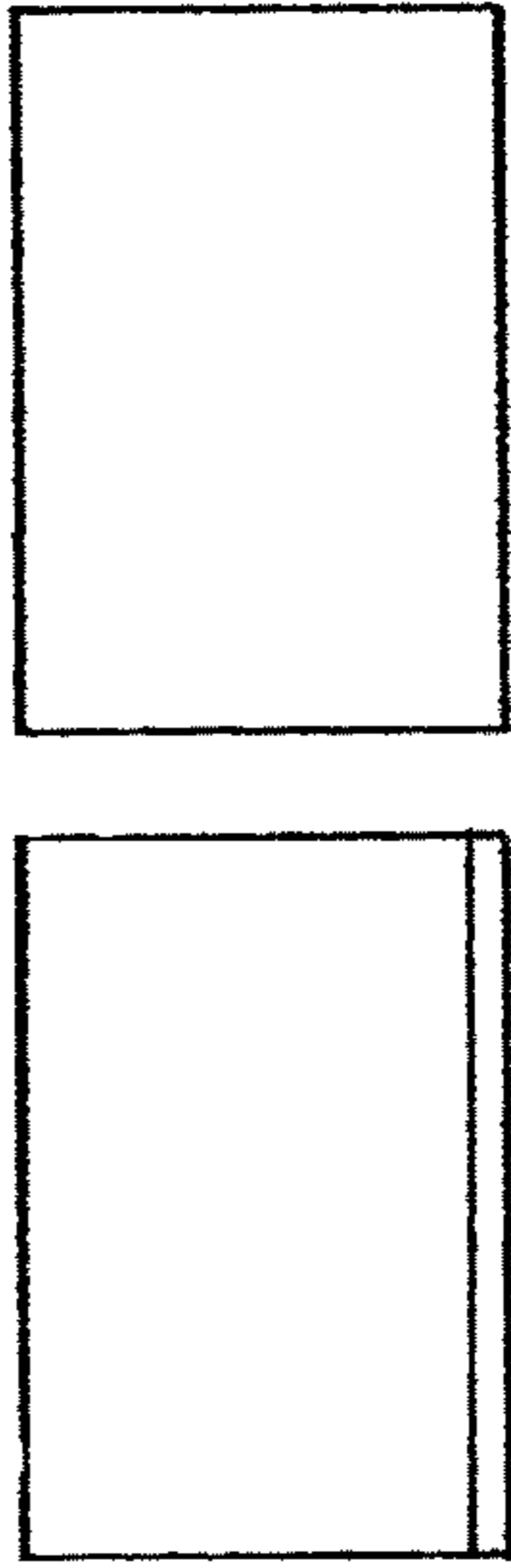

FIG. 23 FIG. 24

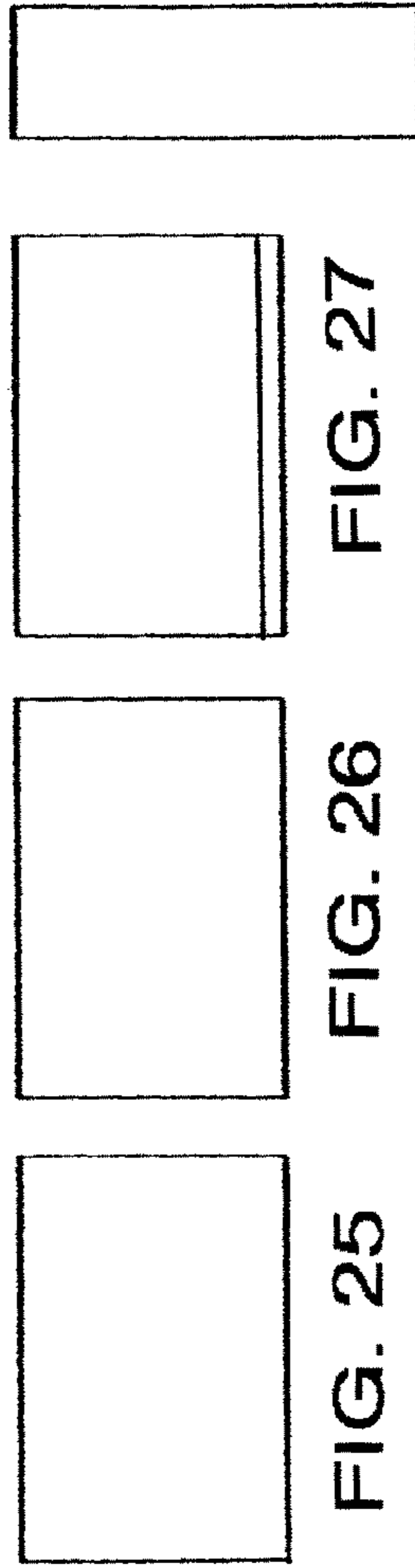

FIG. 25 FIG. 26 FIG. 27 FIG. 28

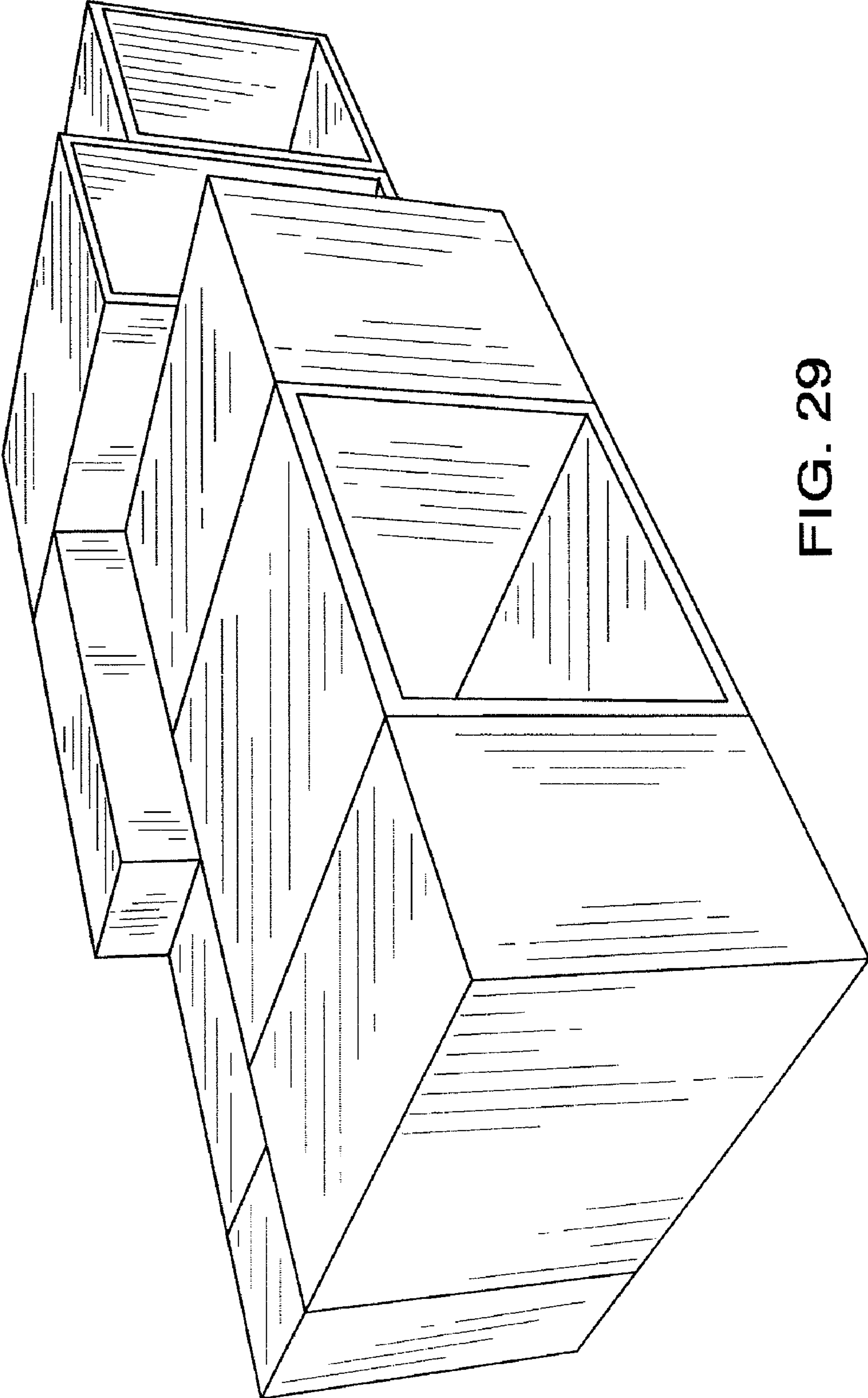

FIG. 29

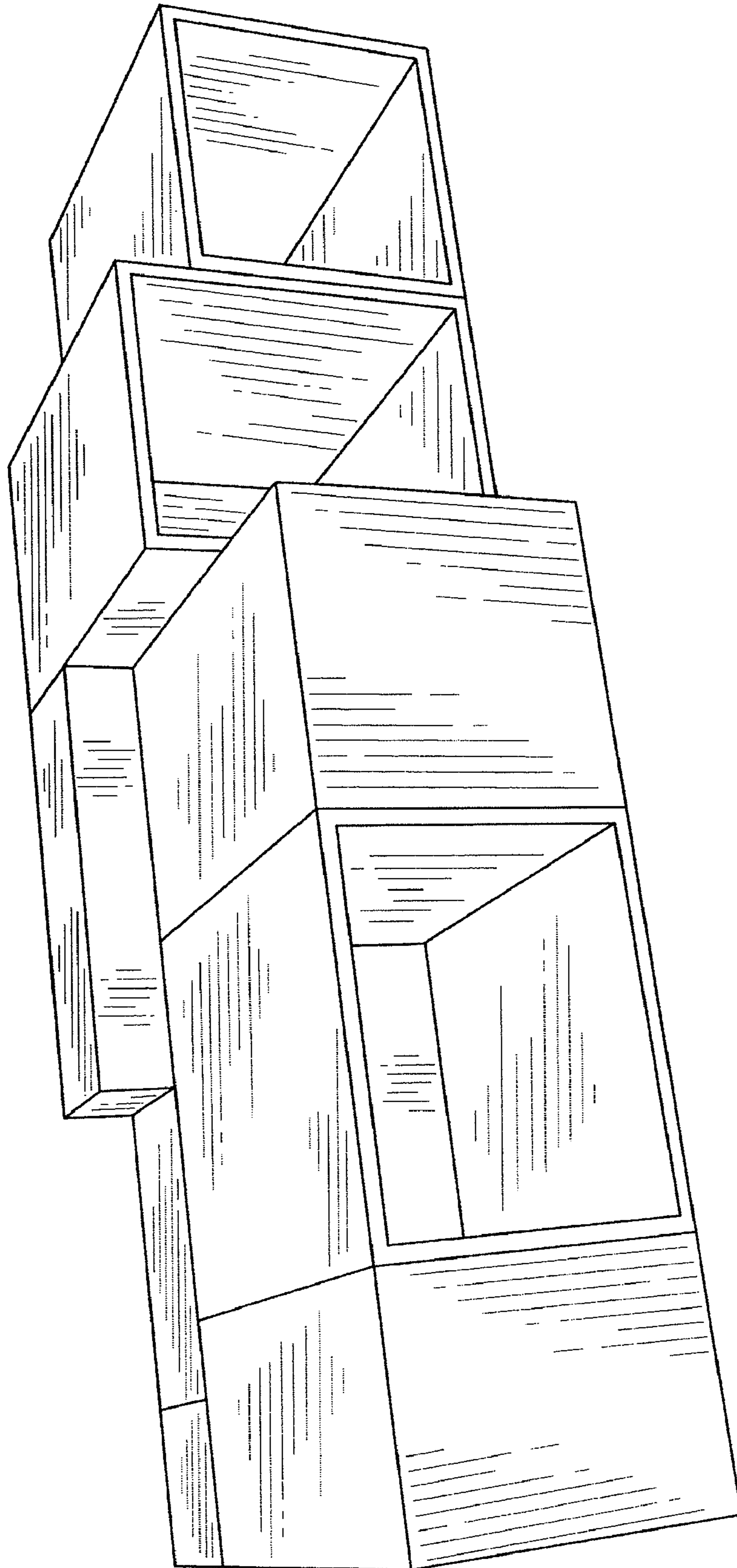

FIG. 30

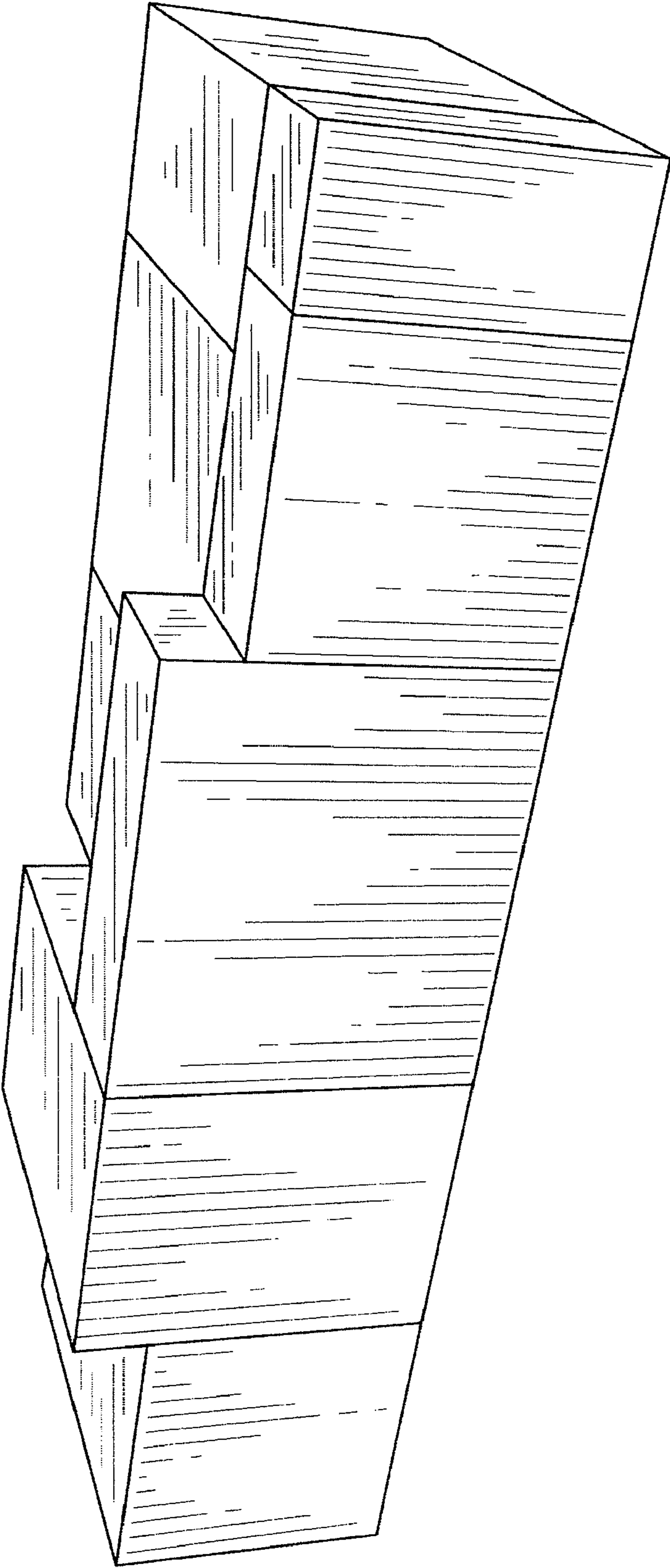

FIG. 31

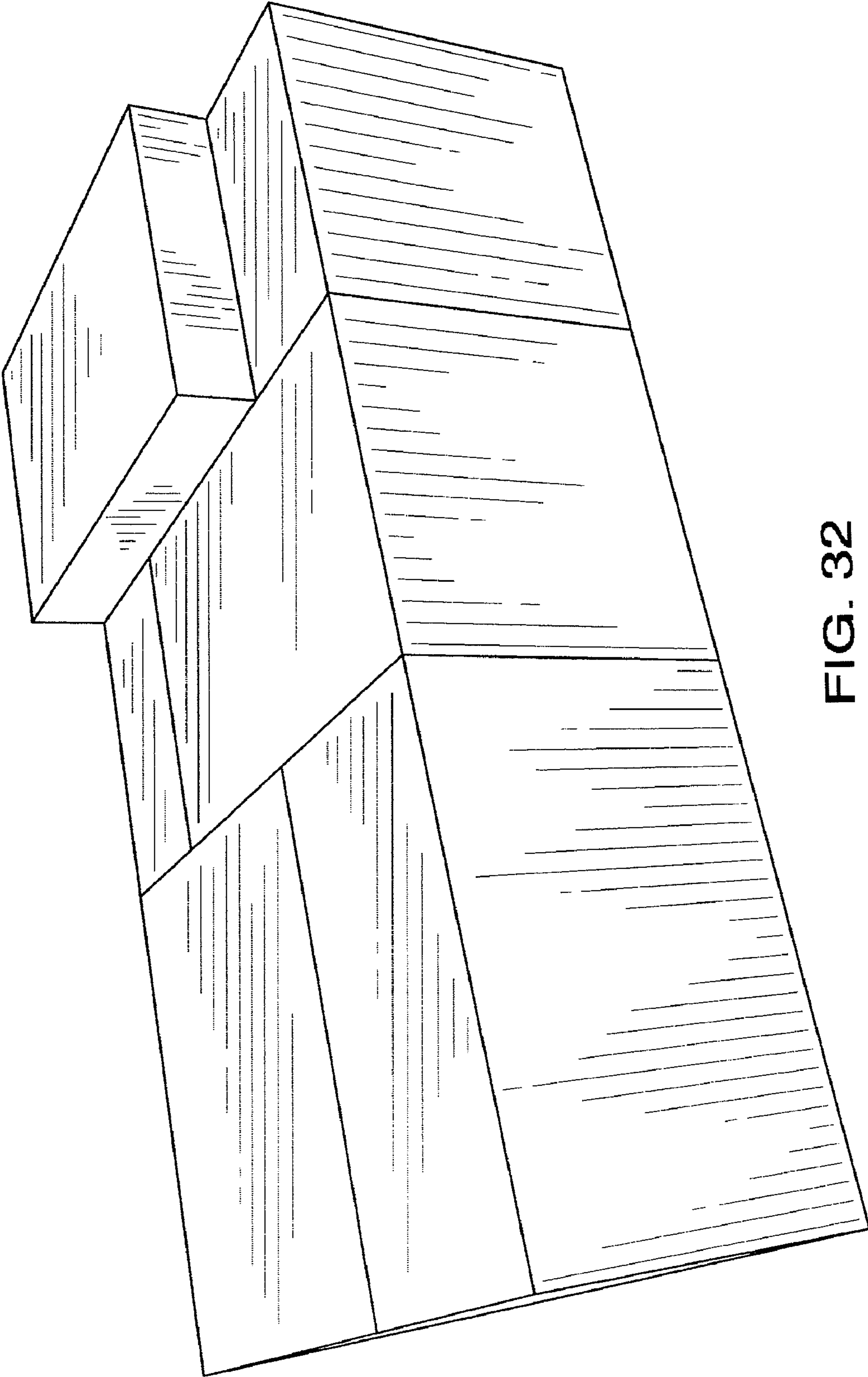

FIG. 32

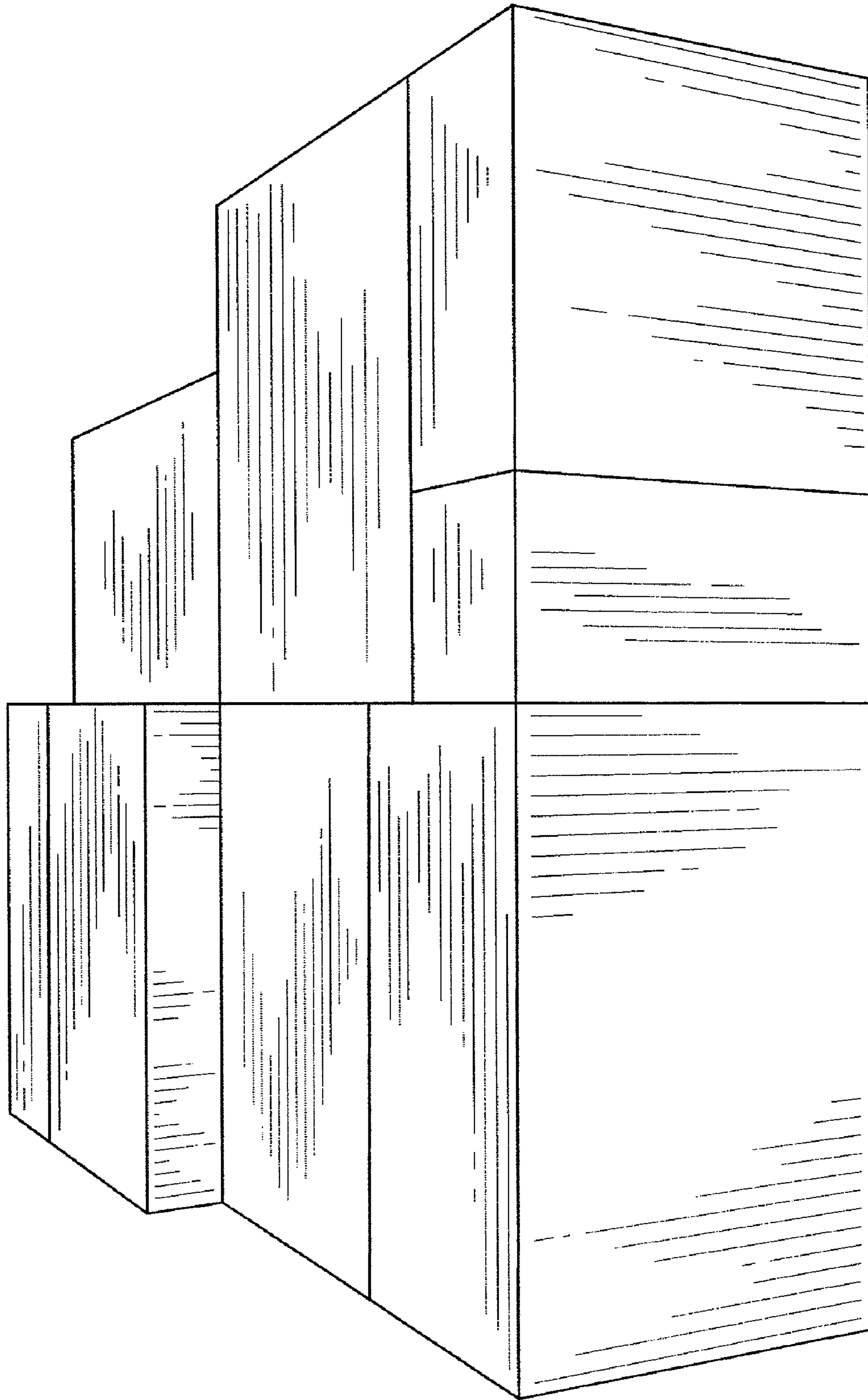

FIG. 33

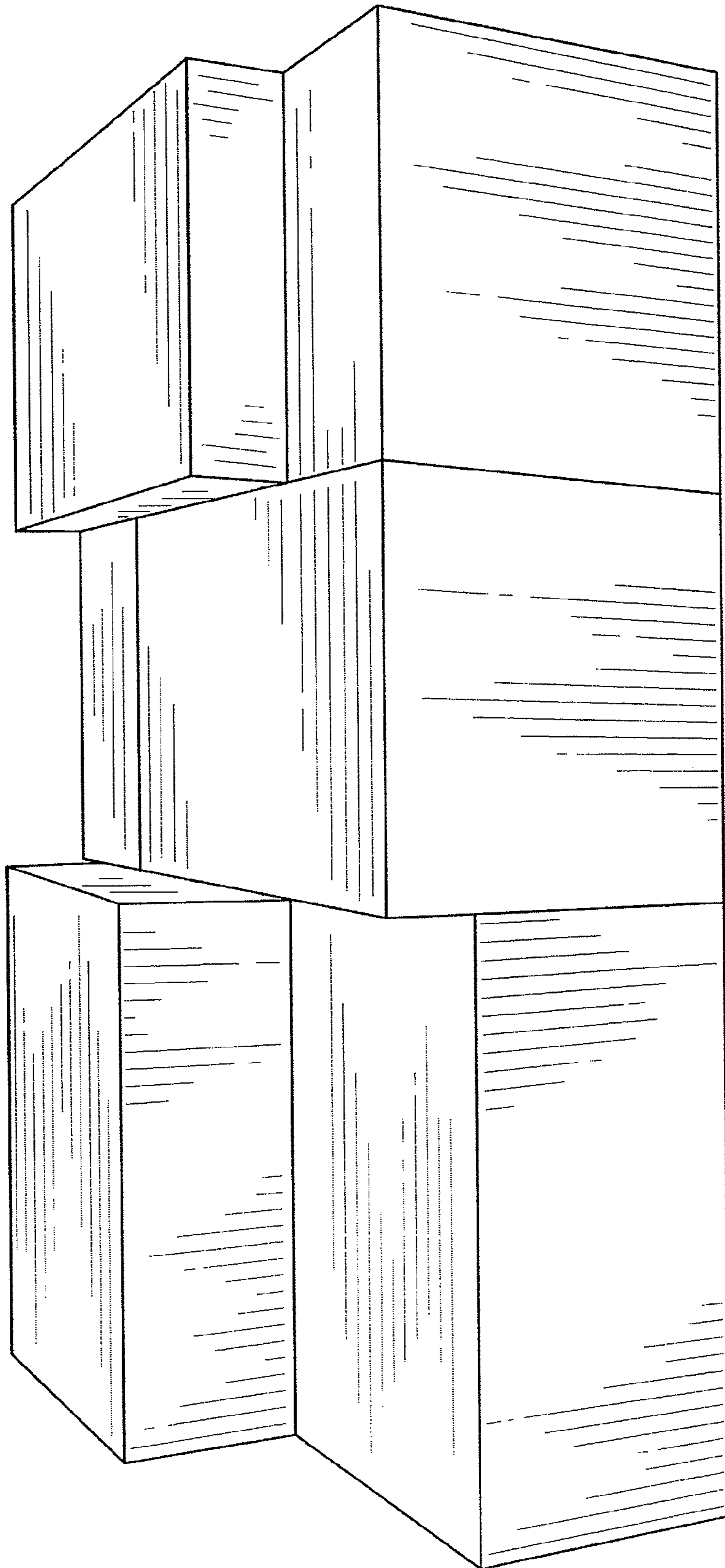

FIG. 34

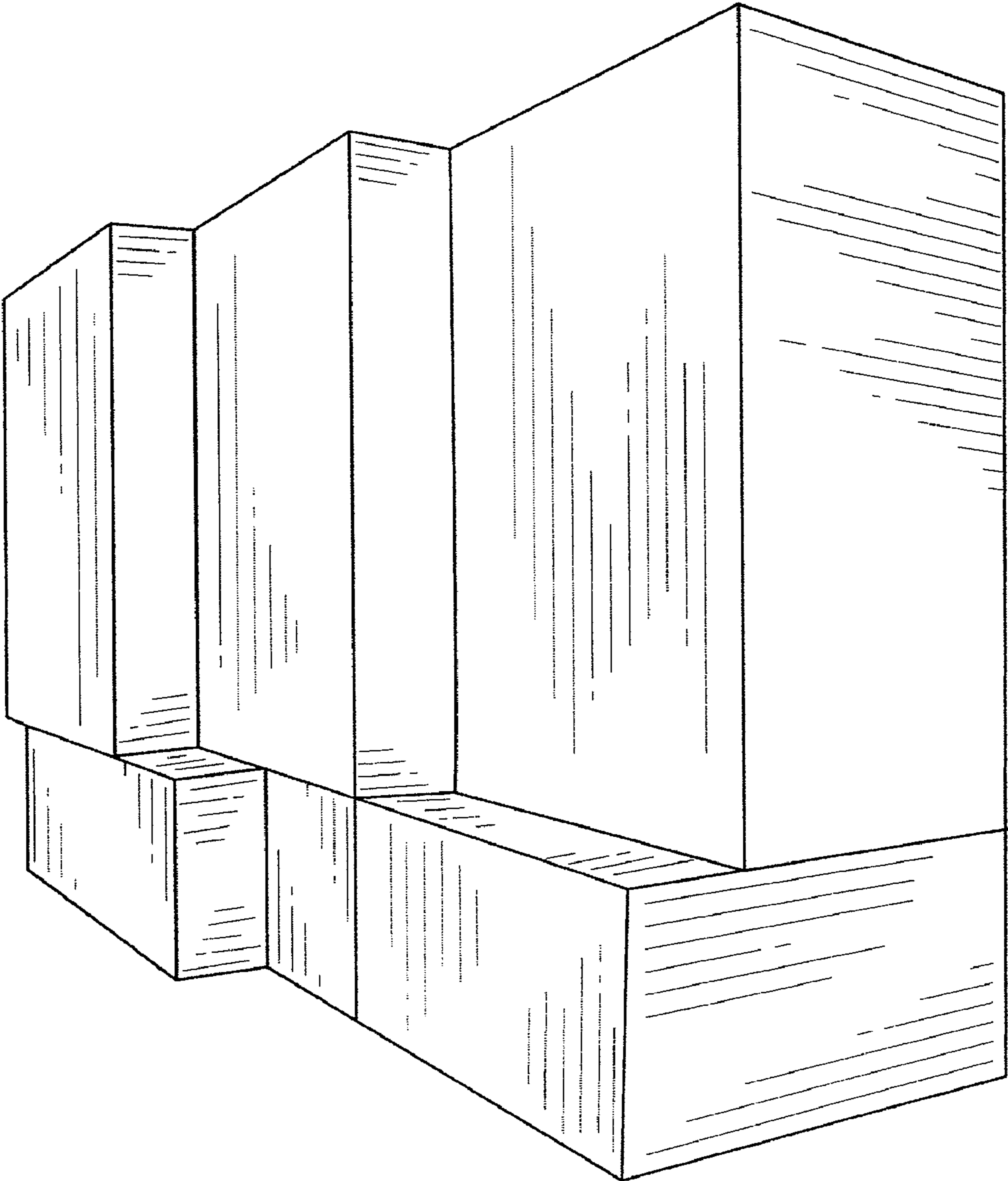

FIG. 35

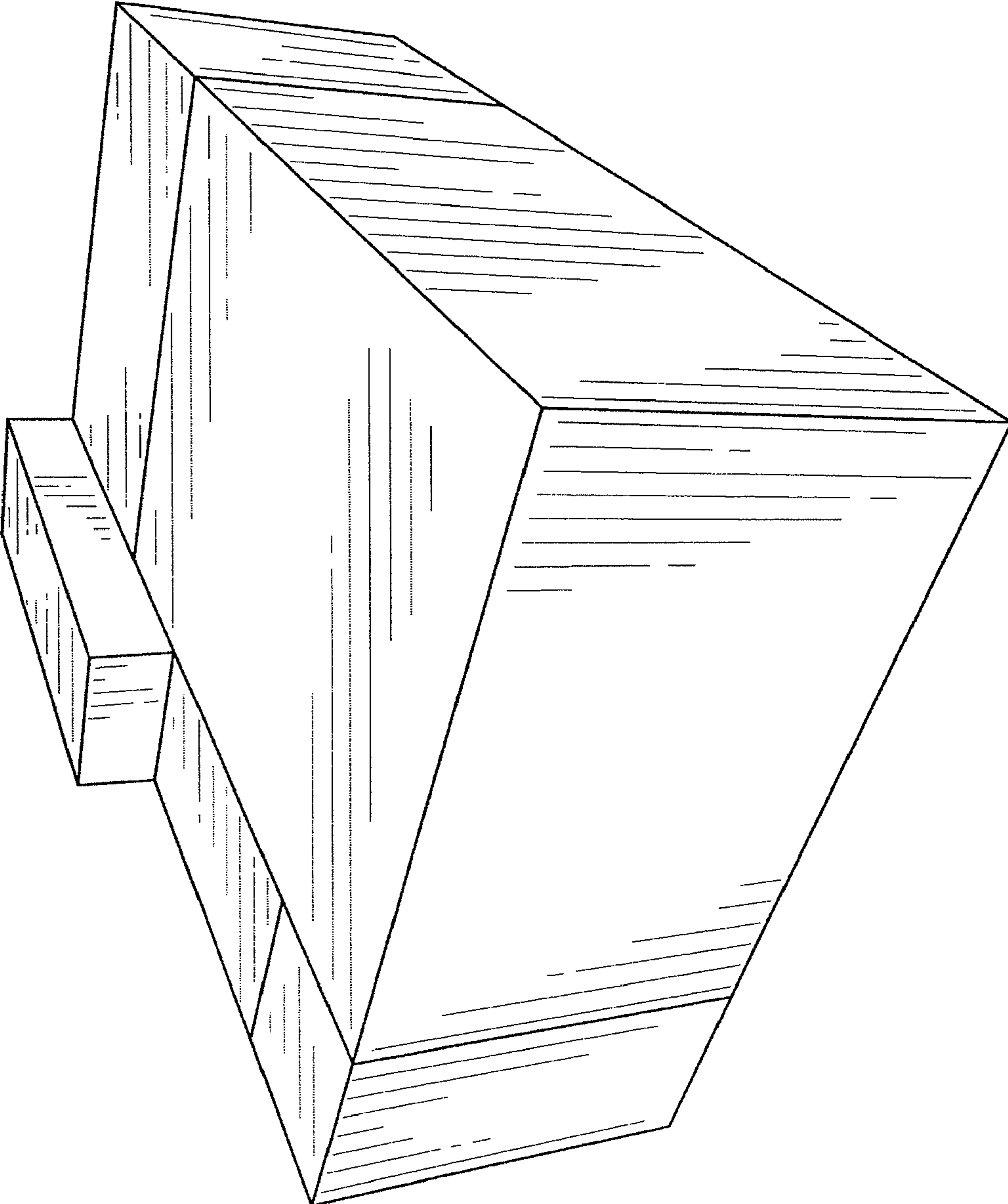

FIG. 36

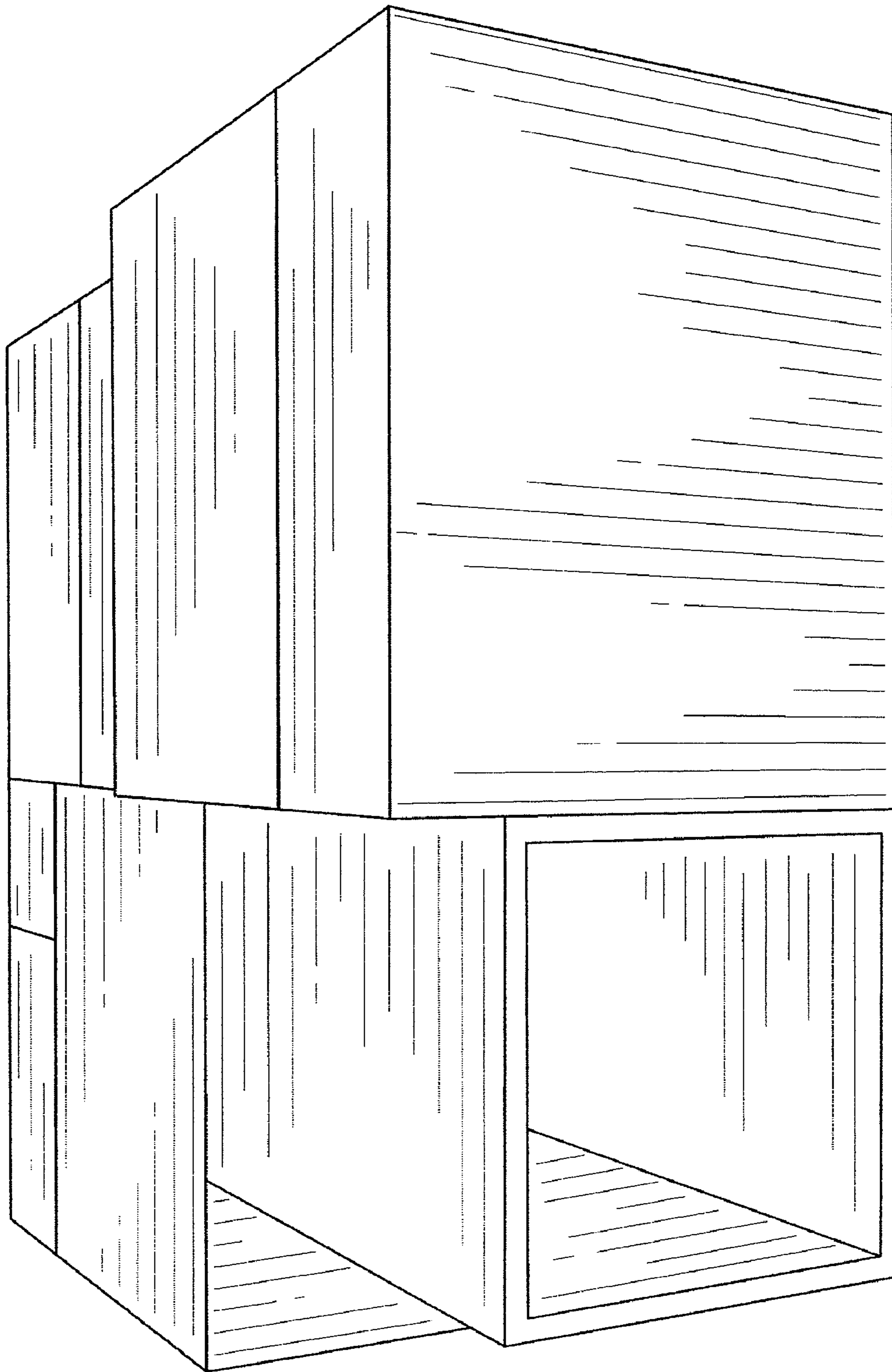

FIG. 37

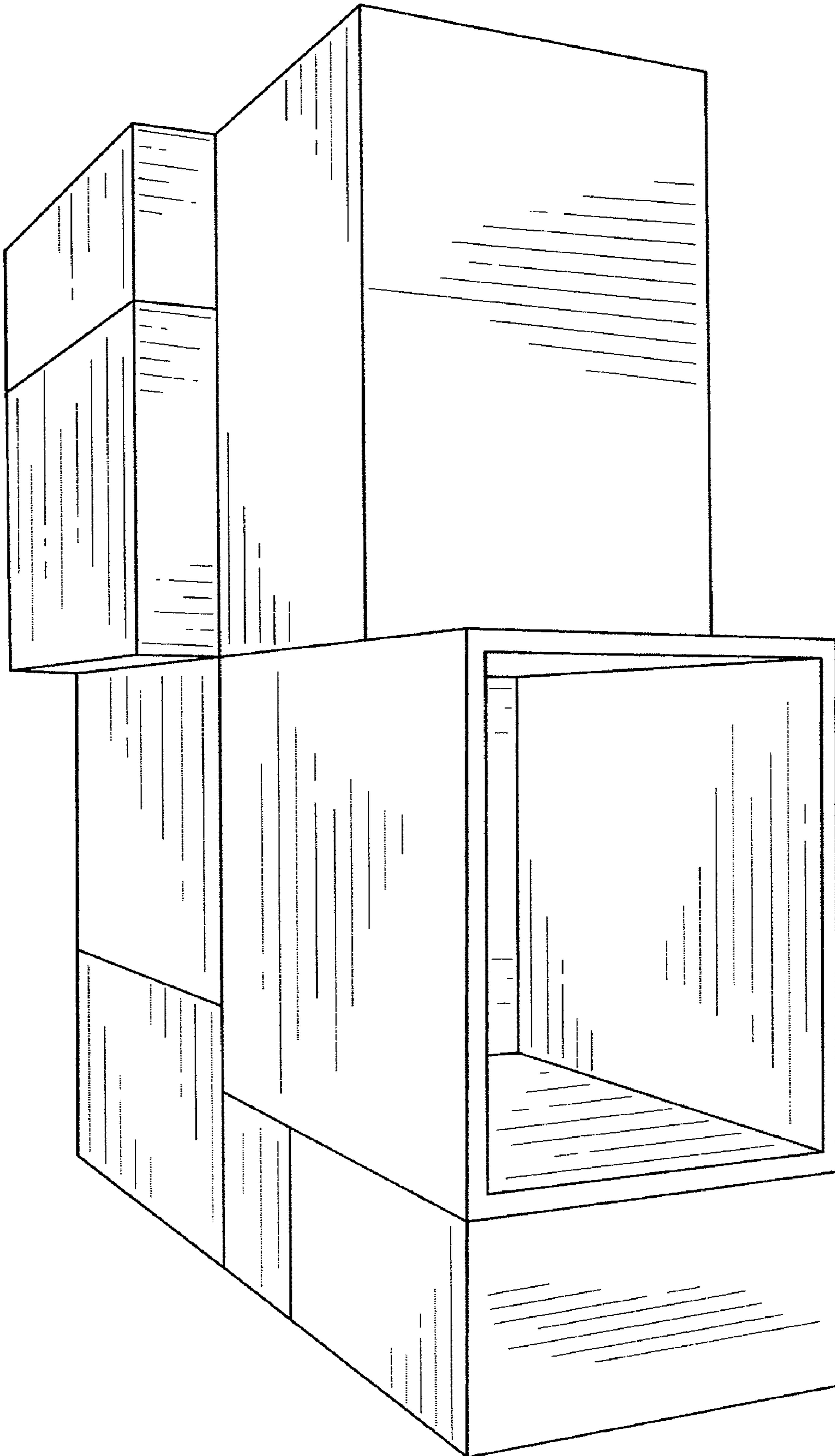

FIG. 38

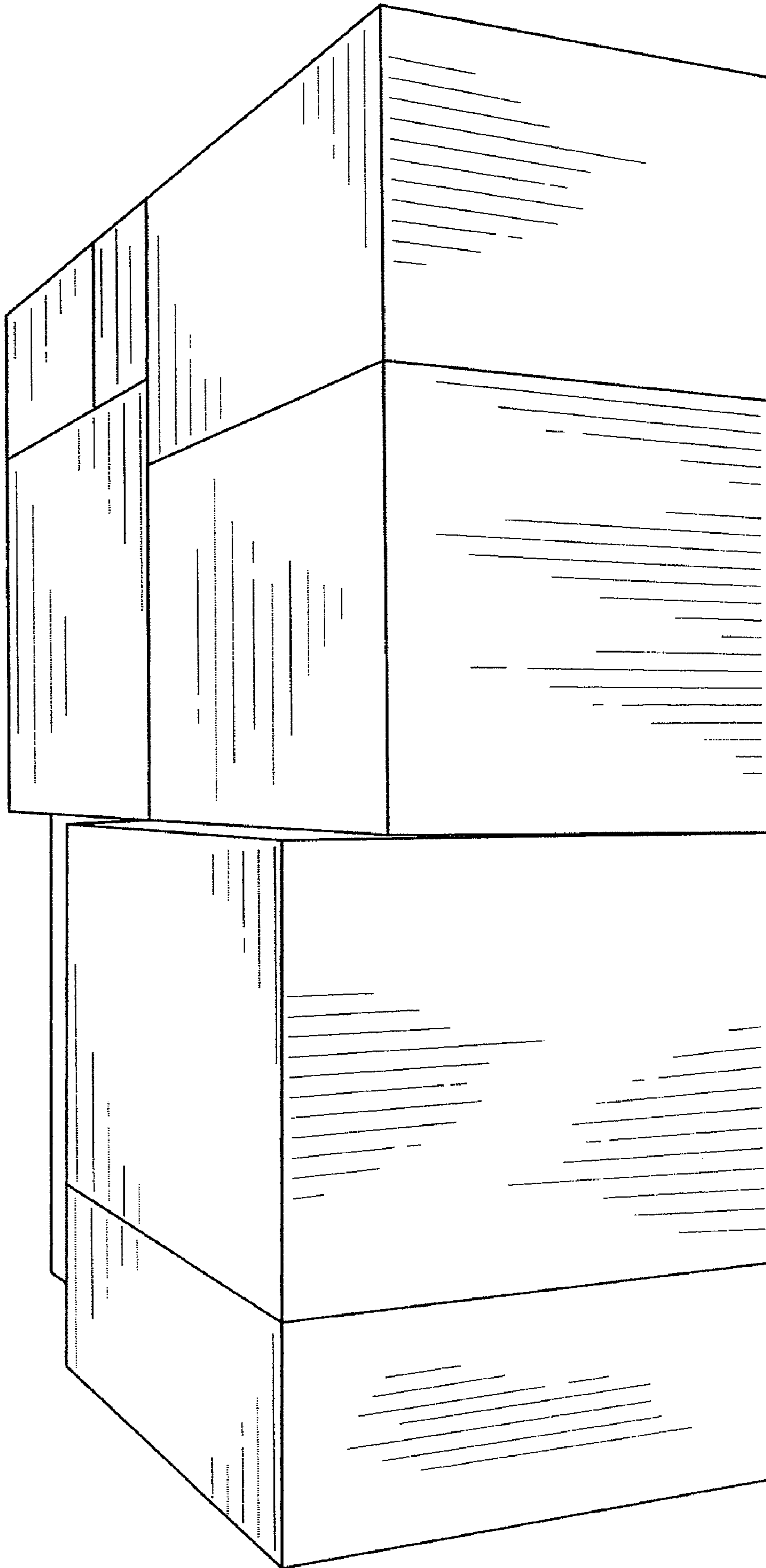

FIG. 39