



US00D667397S

(12) **United States Design Patent**
Koh

(10) **Patent No.:** **US D667,397 S**
(45) **Date of Patent:** **** Sep. 18, 2012**

(54) **TERMINAL FOR PORTABLE MOBILE COMMUNICATION**

(75) Inventor: **Min-Ah Koh**, Seoul (KR)

(73) Assignee: **Samsung Electronics Co., Ltd.**,
Suwon-Si (KR)

(**) Term: **14 Years**

(21) Appl. No.: **29/386,464**

(22) Filed: **Mar. 1, 2011**

(30) **Foreign Application Priority Data**

Dec. 16, 2010 (KR) 30-2010-0054566

(51) **LOC (9) Cl.** **14-02**

(52) **U.S. Cl.** **D14/341**

(58) **Field of Classification Search** D14/341-347,
D14/137, 138, 138.1, 138 A, 138 AA, 138 R,
D14/138 AB, 138 AC, 138 AD, 138 C, 138 G,
D14/496, 203.1, 203.3, 203.4, 203.5, 203.7,
D14/426, 427, 432, 429, 129, 130, 420, 439-441,
D14/448, 125, 147, 156, 218, 247-248, 250,
D14/389, 388, 315-318; D10/65, 104; D18/6-7;
D21/324, 329, 330; D19/26, 59, 60; 455/556.1,
455/556.2, 566, 575.1, 90.3; 379/433.04,
379/433.01, 433.06, 916; 345/169, 173,
345/901, 905; 361/679.26, 679.27, 679.3,
361/679.55, 679.56

See application file for complete search history.

(56) **References Cited**

U.S. PATENT DOCUMENTS

D333,574 S * 3/1993 Ackeret D6/300
D337,569 S * 7/1993 Kando D14/341
D490,420 S * 5/2004 Solomon et al. D14/341
D504,889 S * 5/2005 Andre et al. D14/341
D580,431 S * 11/2008 Morita D14/341
D598,016 S * 8/2009 Han et al. D14/341

D600,690 S * 9/2009 Miyaji D14/341
D602,487 S * 10/2009 Maskatia D14/341
D617,793 S * 6/2010 Chiang et al. D14/341
D622,240 S * 8/2010 Liu et al. D14/126
D622,270 S * 8/2010 Andre et al. D14/341
D622,514 S * 8/2010 Park et al. D6/308
D626,437 S * 11/2010 Lee et al. D10/65
D627,777 S * 11/2010 Akana et al. D14/341
D633,090 S * 2/2011 Andre et al. D14/341
D636,391 S * 4/2011 Shen et al. D14/341
D636,770 S * 4/2011 Li D14/341
D639,266 S * 6/2011 Delorenzo et al. D14/142
D641,018 S * 7/2011 Lee et al. D14/341
D646,902 S * 10/2011 Woo et al. D6/308
D652,418 S * 1/2012 Rashid et al. D14/341
D654,074 S * 2/2012 Wood et al. D14/341
D657,764 S * 4/2012 Hong D14/138 G
2005/0168925 A1* 8/2005 Fang et al. 361/683

* cited by examiner

Primary Examiner — Barbara Fox

(74) *Attorney, Agent, or Firm* — Staas & Halsey LLP

(57) **CLAIM**

The ornamental design for a terminal for portable mobile communication, as shown and described.

DESCRIPTION

FIG. 1 is a front perspective view of a terminal for portable mobile communication;
FIG. 2 is a front view of the terminal for portable mobile communication of FIG. 1;
FIG. 3 is a rear view of the terminal for portable mobile communication of FIG. 1;
FIG. 4 is a left-side view of the terminal for portable mobile communication of FIG. 1;
FIG. 5 is a right-side view of the terminal for portable mobile communication of FIG. 1;
FIG. 6 is a top plan view of the terminal for portable mobile communication of FIG. 1; and,
FIG. 7 is a bottom plan view of the terminal for portable mobile communication of FIG. 1.

1 Claim, 7 Drawing Sheets

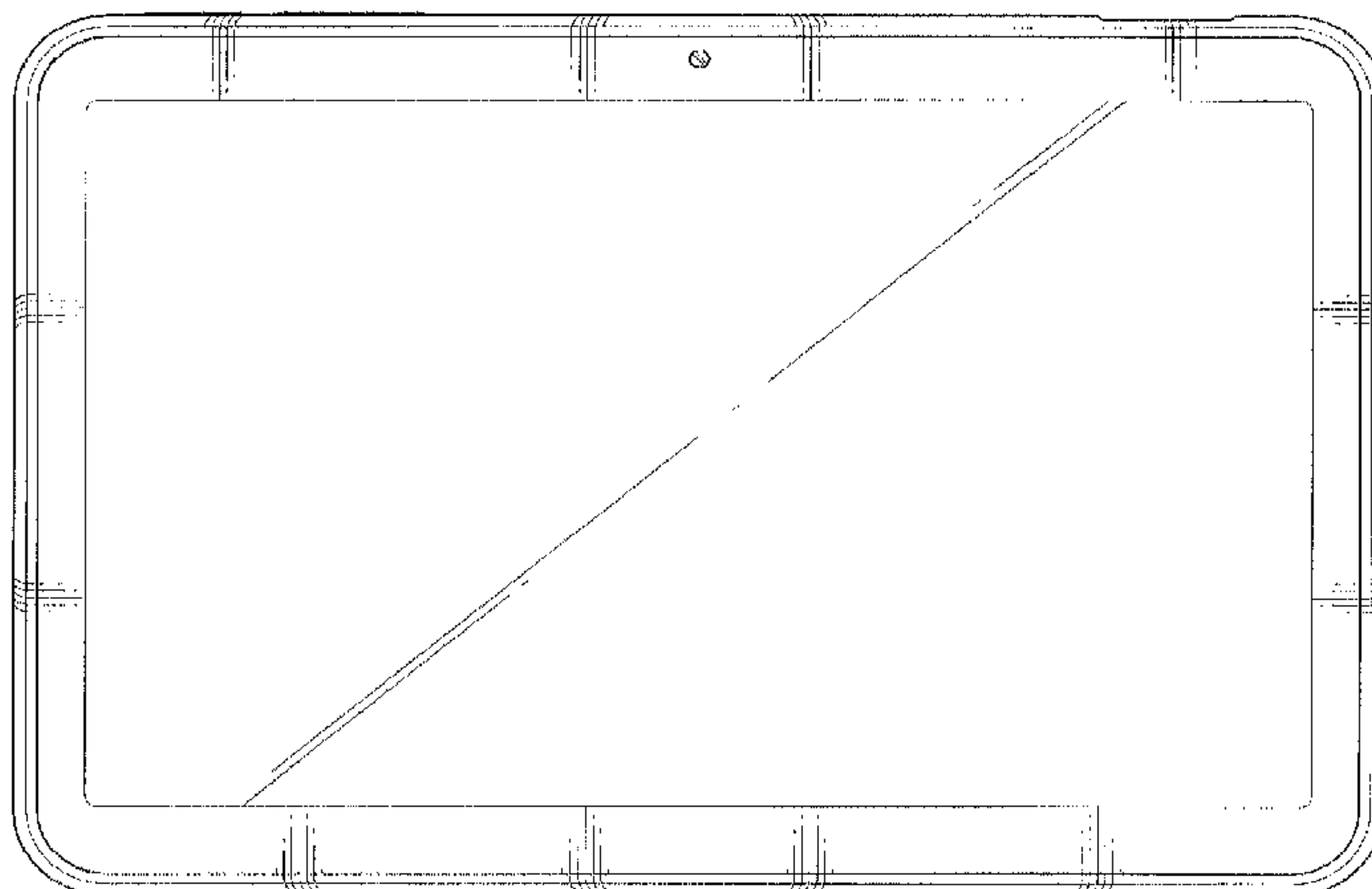

FIG. 1

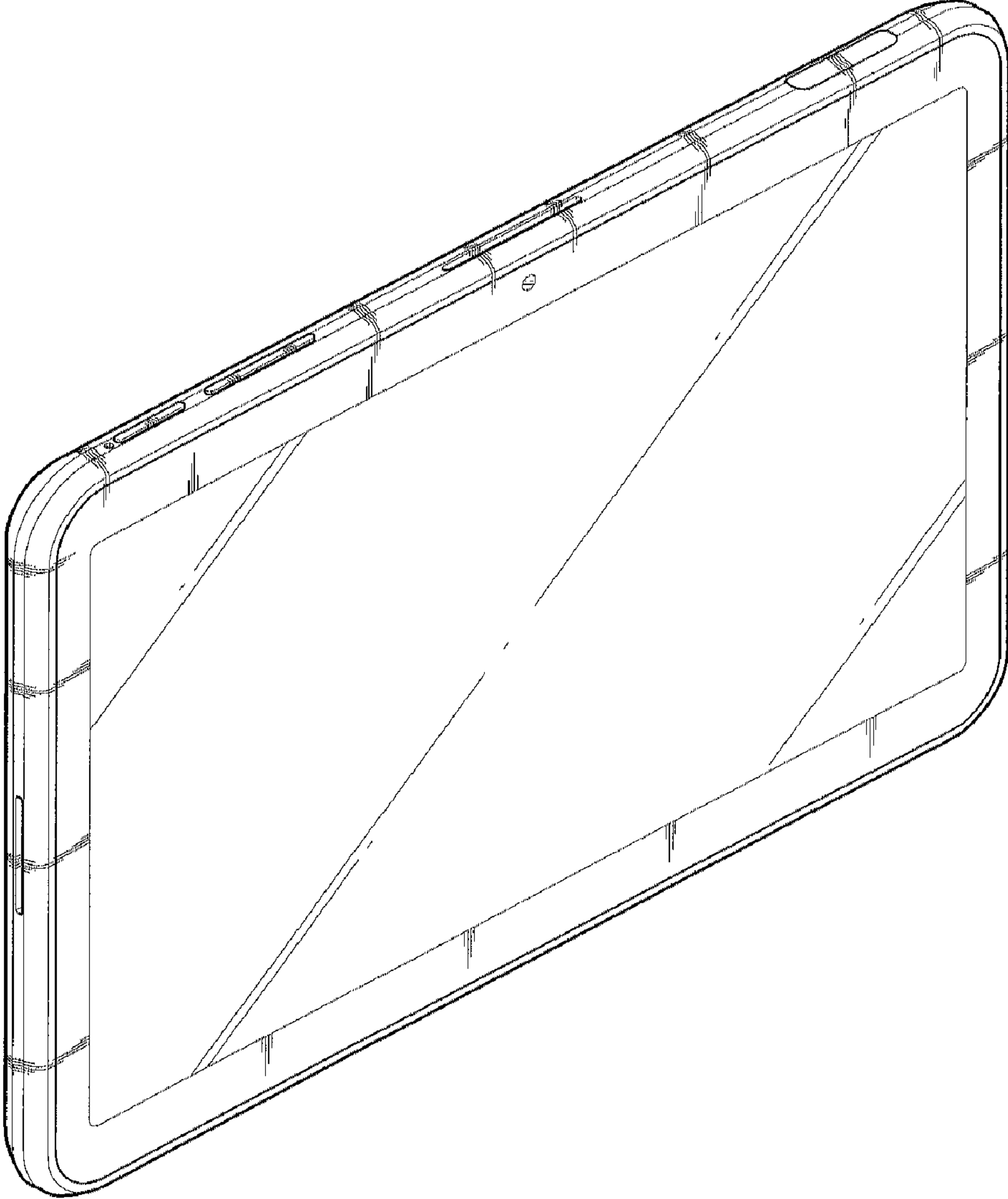

FIG. 2

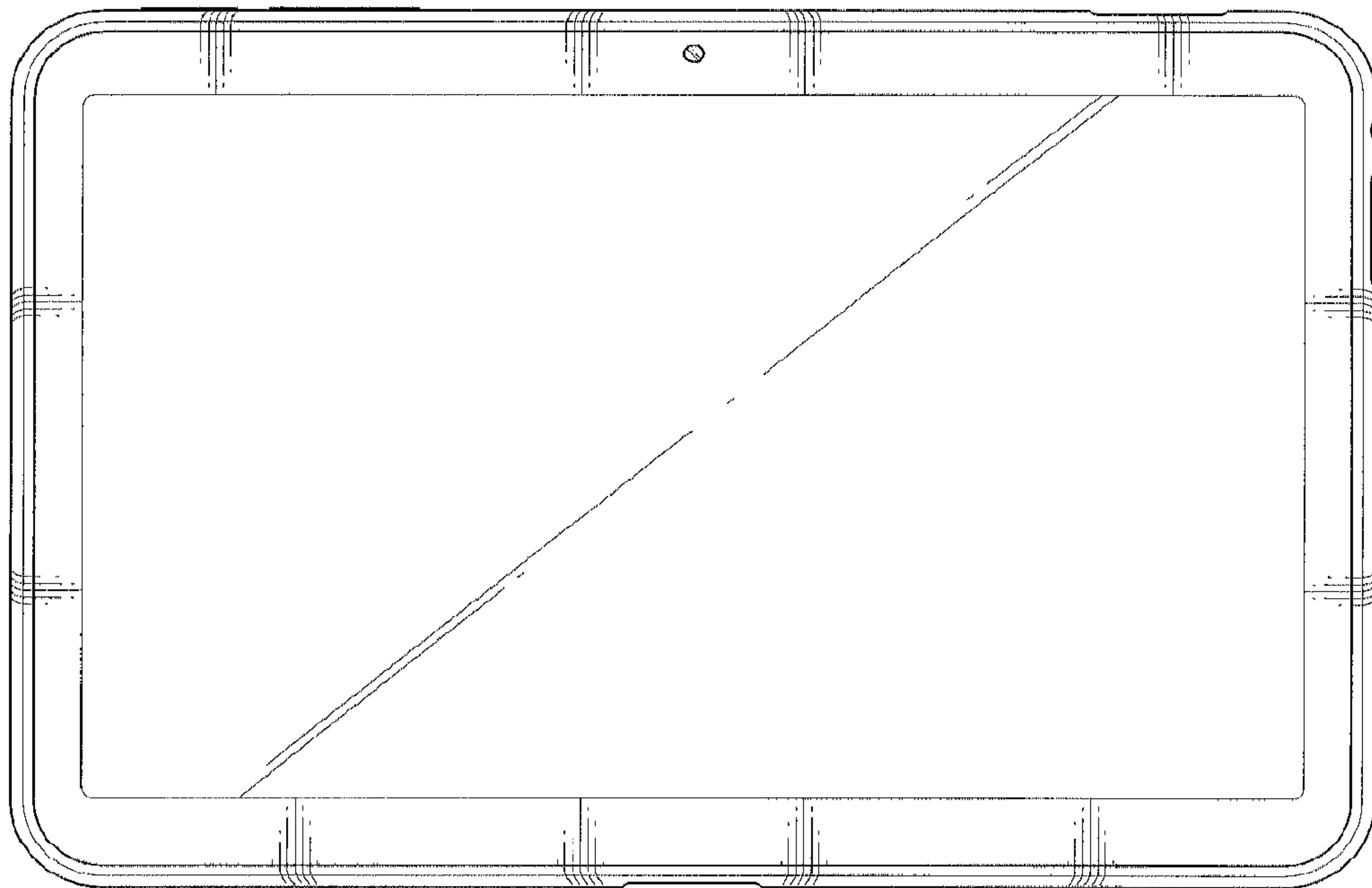

FIG. 3

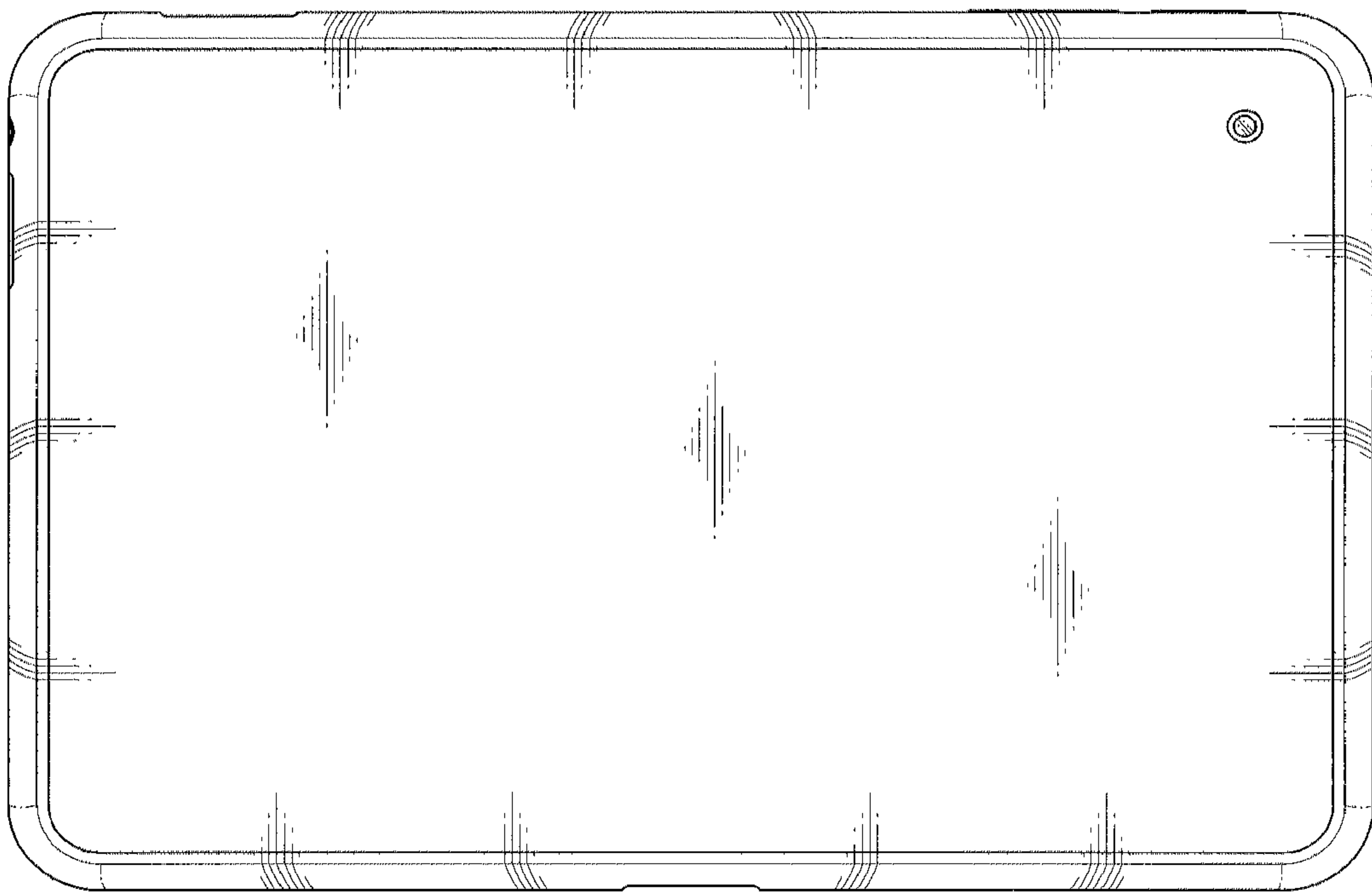

FIG. 4

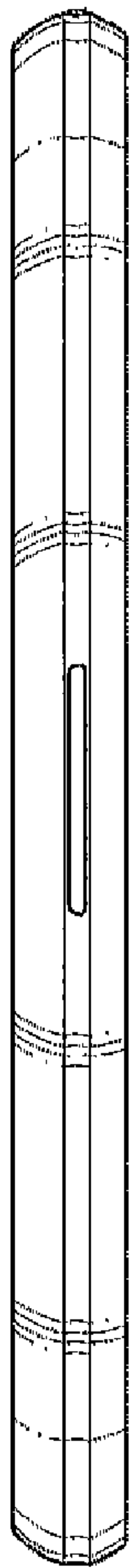

FIG. 5

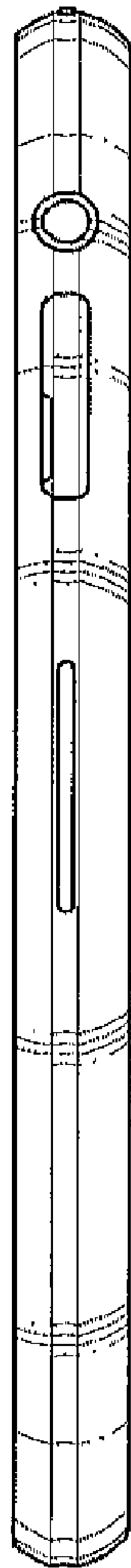

FIG. 6

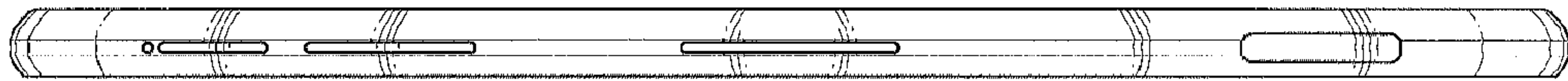

FIG. 7

