



US00D667390S

(12) **United States Design Patent**
Matera

(10) **Patent No.:** **US D667,390 S**
(45) **Date of Patent:** **** Sep. 18, 2012**

- (54) **ADHESIVE CORD RETAINER FOR A PERSONAL MEDIA PLAYER**
 - (76) Inventor: **Kenneth J. Matera**, Massapequa, NY (US)
 - (**) Term: **14 Years**
 - (21) Appl. No.: **29/400,211**
 - (22) Filed: **Aug. 24, 2011**
 - (51) **LOC (9) Cl.** **14-01**
 - (52) **U.S. Cl.** **D14/223; D14/224**
 - (58) **Field of Classification Search** D14/205, D14/206, 223, 224; 181/129, 130, 135; 379/430, 379/431; 381/380, 381; 242/378.1; D10/72; 455/90.3, 575.1
- See application file for complete search history.

(56) **References Cited**

U.S. PATENT DOCUMENTS

2,533,341	A *	12/1950	Alfano	242/388
3,450,369	A *	6/1969	Olzak et al.	242/385.1
3,984,645	A *	10/1976	Kresch	379/430
4,150,798	A *	4/1979	Aragon	242/388.1
4,200,249	A *	4/1980	Synstelien et al.	242/396.5
4,497,457	A *	2/1985	Harvey	242/405.1
4,802,638	A *	2/1989	Burger et al.	242/388.1
4,851,498	A *	7/1989	Hawkins	528/190
4,910,362	A	3/1990	Kinner		
D316,030	S *	4/1991	Adielsson	D8/358
5,074,074	A *	12/1991	Yeadon	42/95
5,422,957	A *	6/1995	Cummins	381/384
D372,188	S *	7/1996	Van Dyke	D8/358
5,984,224	A *	11/1999	Yang	242/400.1
5,992,787	A *	11/1999	Burke	242/388.1
6,059,081	A *	5/2000	Patterson et al.	191/12.2 R
D451,075	S *	11/2001	Hwang	D13/154
D456,692	S *	5/2002	Epstein	D8/356
D458,534	S *	6/2002	Morris et al.	D8/358
D461,168	S *	8/2002	Liao	D13/155
6,480,611	B2 *	11/2002	Hashimoto et al.	381/371
6,616,080	B1 *	9/2003	Edwards et al.	242/378.1

6,658,130	B2 *	12/2003	Huang	381/384
6,698,560	B2	3/2004	Reardon et al.		
6,728,388	B1 *	4/2004	Nageno et al.	381/381
6,866,219	B2 *	3/2005	Wei	242/378.4
D505,859	S *	6/2005	Suzuki	D8/358
6,942,173	B1	9/2005	Abramov		
7,108,544	B2	9/2006	Zoller		
D542,123	S *	5/2007	Symons	D8/356
D566,107	S *	4/2008	Bowling	D14/223
7,372,974	B2 *	5/2008	Yanagishita et al.	381/384
D575,143	S	8/2008	Kuo et al.		
D583,362	S *	12/2008	Hsu et al.	D14/205
D600,673	S	9/2009	Kim et al.		
D643,419	S *	8/2011	Huang	D14/223
8,167,102	B2 *	5/2012	Skillman	191/12.2 R
2009/0238395	A1	9/2009	Jubelirer et al.		

* cited by examiner

Primary Examiner — Paula Greene

(57) **CLAIM**

The ornamental design for an adhesive cord retainer for a personal media player, as shown and described.

DESCRIPTION

FIG. 1 is a perspective view of an adhesive cord retainer for a personal media player showing my new design;
 FIG. 2 is a front view thereof;
 FIG. 3 is a back view thereof;
 FIG. 4 is a side view (opposite side view is mirror image) thereof;
 FIG. 5 is a top view thereof;
 FIG. 6 is a bottom view thereof; and,
 FIG. 7 is another perspective view of an in-use adhesive cord retainer for a personal media player thereof.
 In FIG. 7, the broken lines showing of environment structure for purpose of illustrating the adhesive cord retainer for a personal media player in a condition of use. The broken lines and the structure they depict form no part of the claimed design.

1 Claim, 5 Drawing Sheets

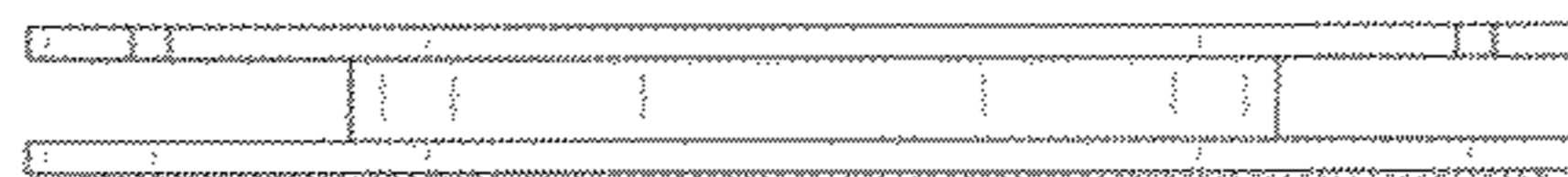
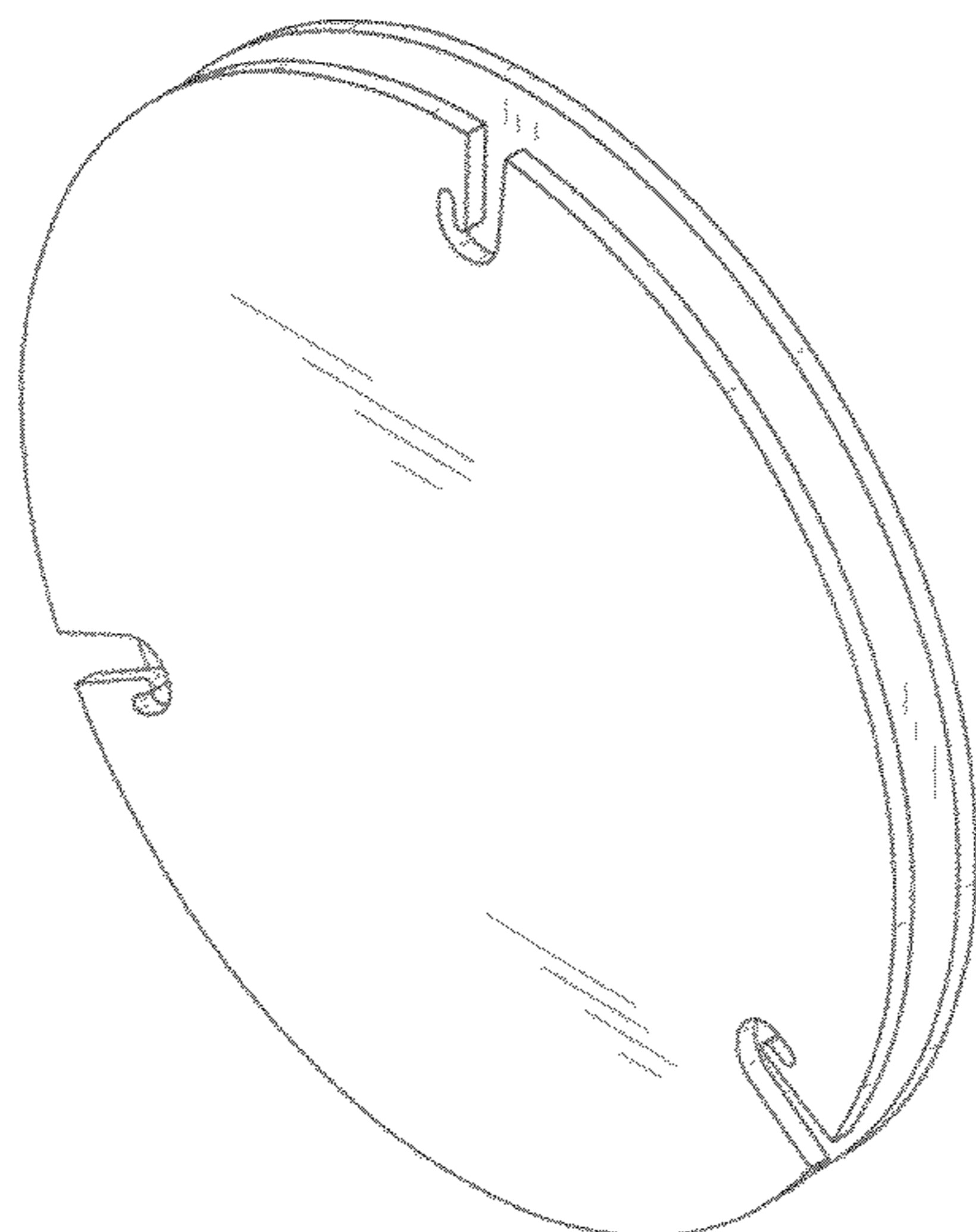

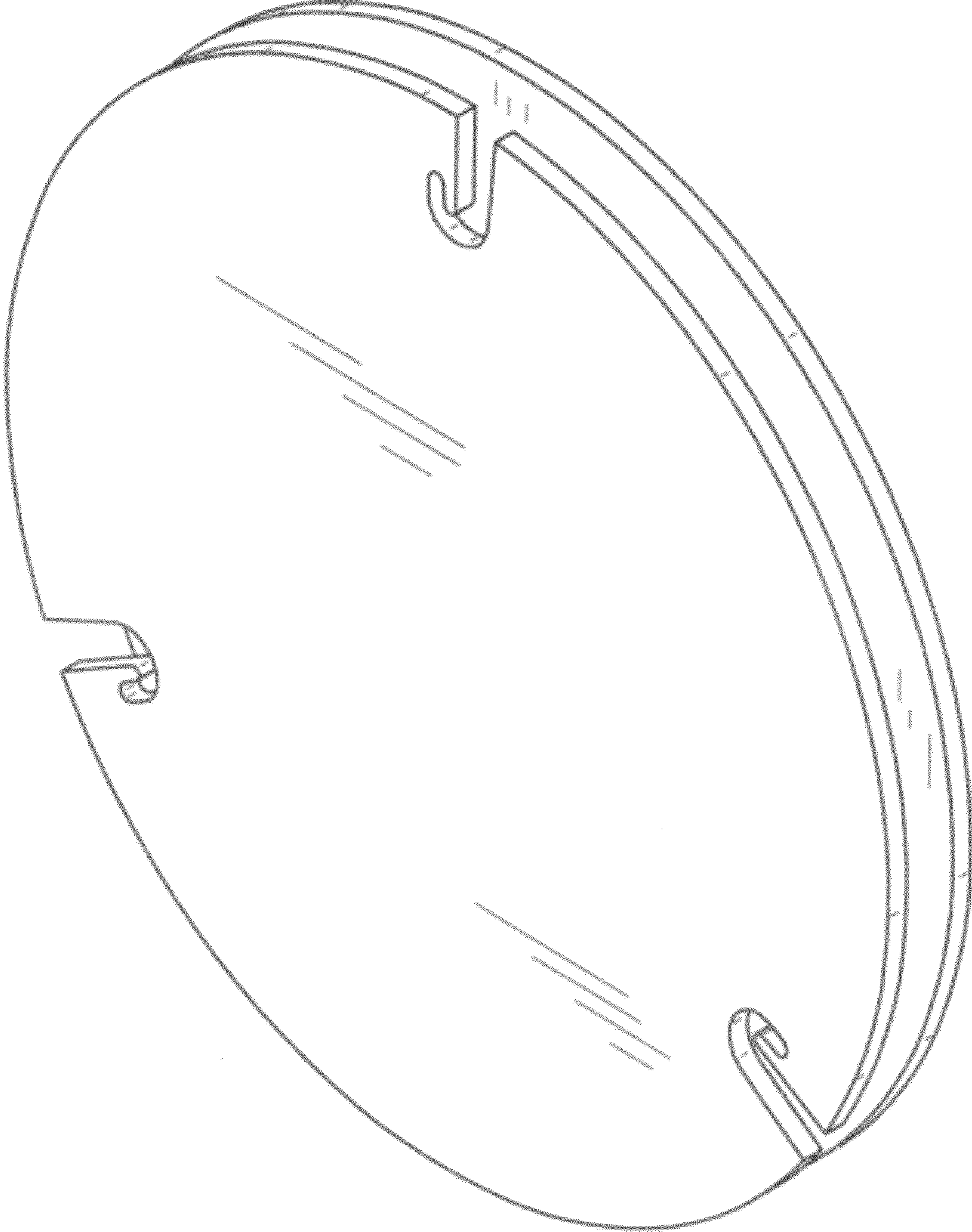

FIG. 1

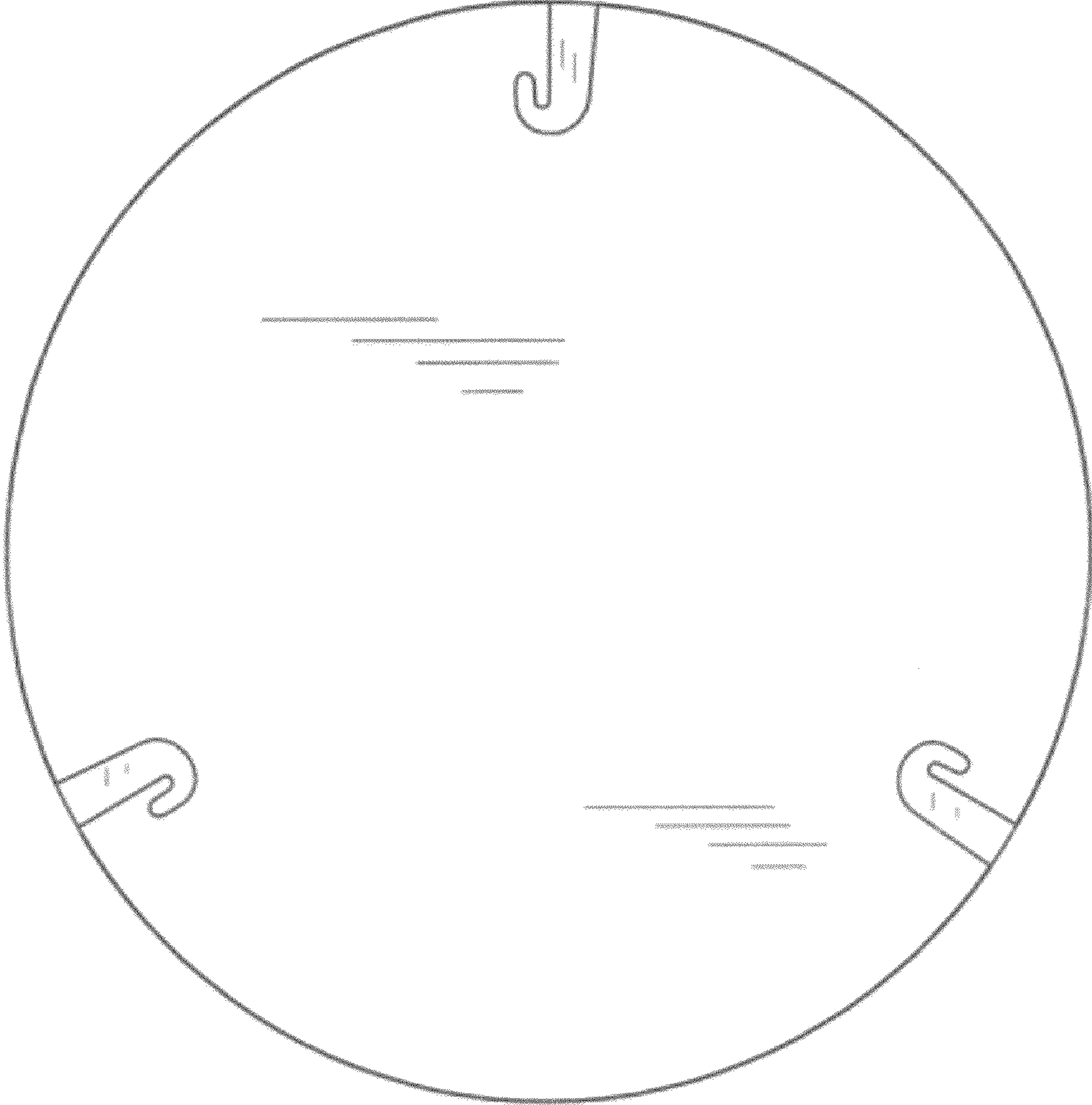

FIG. 2

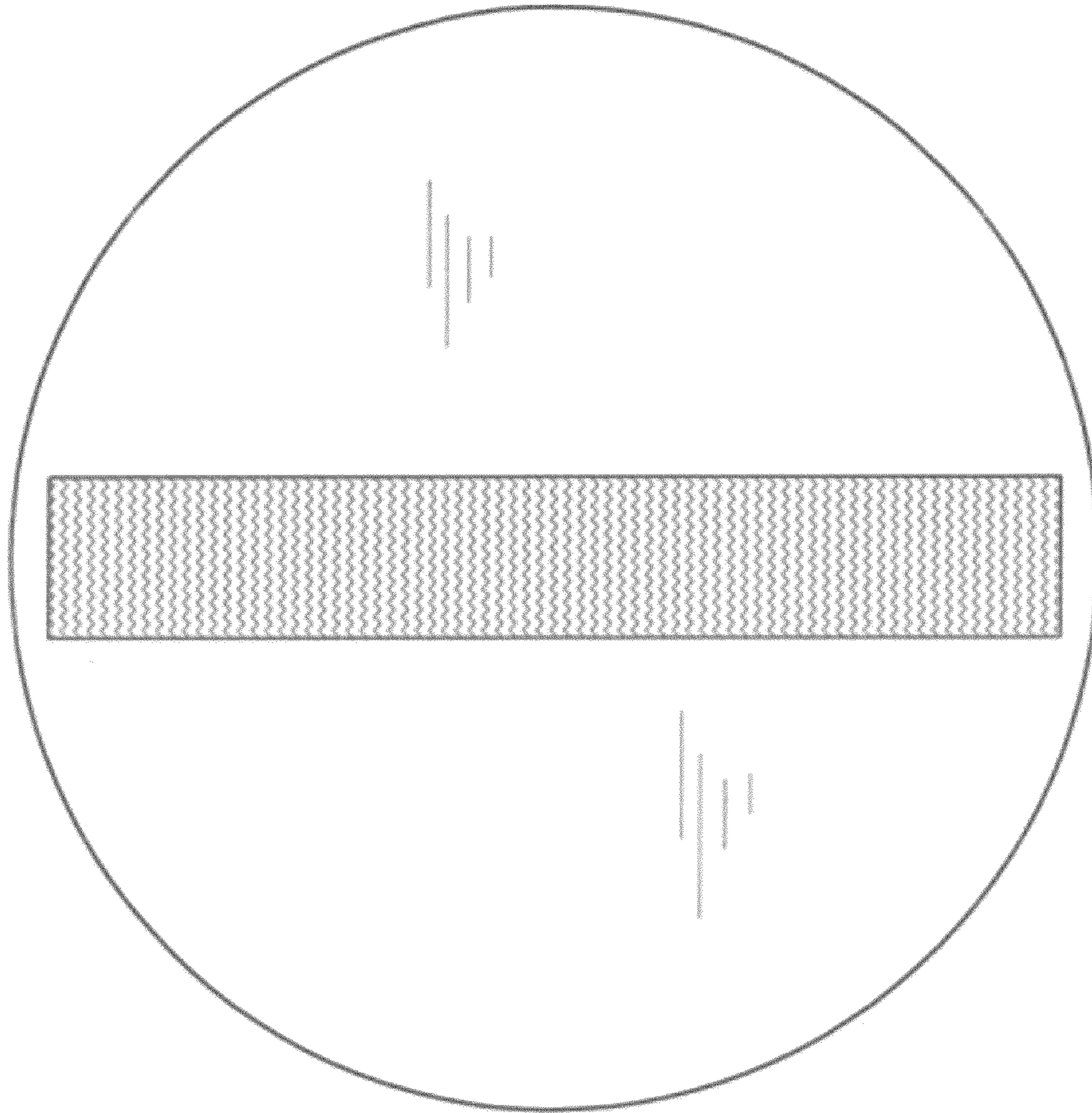

FIG. 3

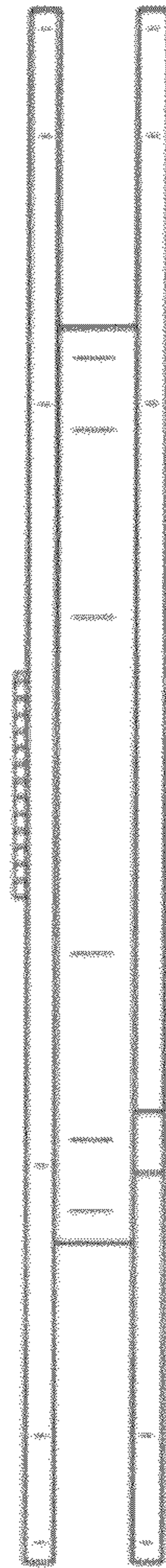

FIG. 4



FIG. 5

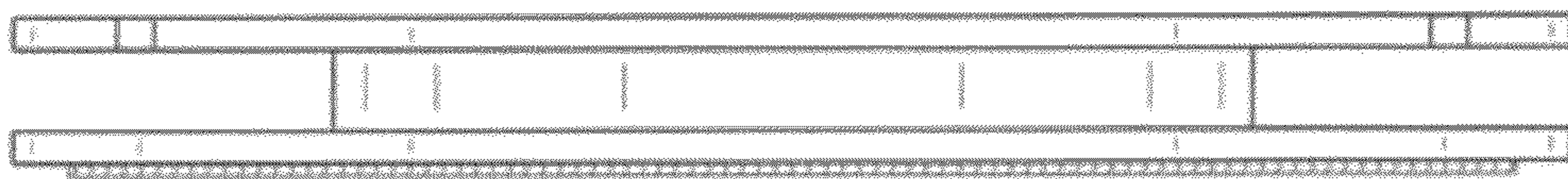

FIG. 6

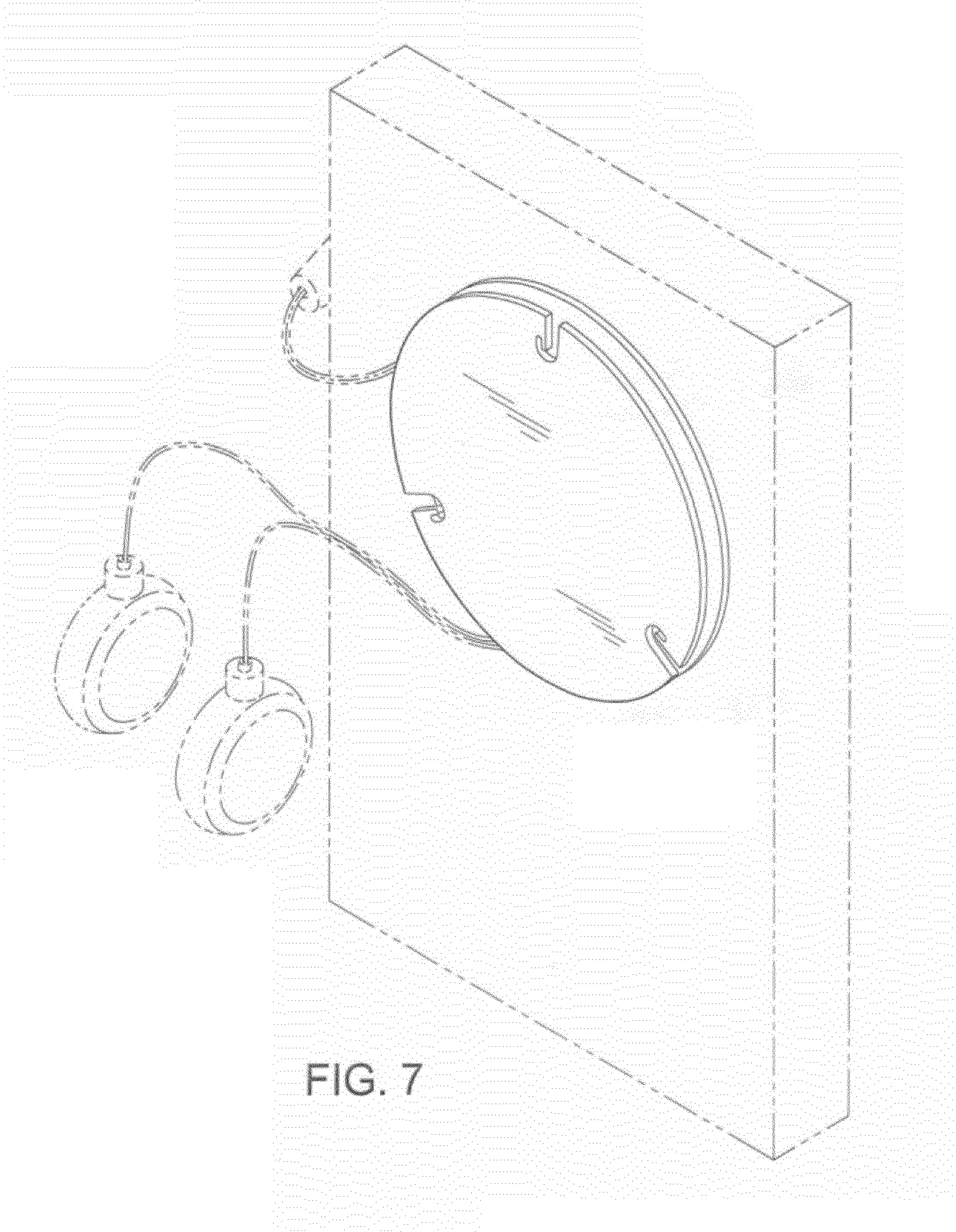

FIG. 7