

US00D667320S

(12) **United States Design Patent**
Conwell

(10) **Patent No.:** **US D667,320 S**

(45) **Date of Patent:** **** Sep. 18, 2012**

(54) **WATCH**

(75) **Inventor:** **Brian Conwell**, Middletown, RI (US)

(73) **Assignee:** **Albedeaux Watch Co.**, Newport, RI (US)

(**) **Term:** **14 Years**

(21) **Appl. No.:** **29/416,329**

(22) **Filed:** **Mar. 21, 2012**

(51) **LOC (9) Cl.** **10-02**

(52) **U.S. Cl.** **D10/39**

(58) **Field of Classification Search** D10/30-39,
D10/123-126; 368/276, 281, 282, 223, 80
See application file for complete search history.

(56) **References Cited**

U.S. PATENT DOCUMENTS

2,385,234	A *	9/1945	Schmitz	368/288
D178,770	S *	9/1956	Doerwald	D10/39
D186,180	S *	9/1959	Diamond	D10/39
2,968,910	A *	1/1961	Taubert	368/289
D362,395	S *	9/1995	Chodat	D10/30
D365,526	S *	12/1995	Gardner	D10/39
5,508,979	A *	4/1996	Eisenegger	368/15
D444,716	S *	7/2001	Bodino	D10/32

D452,174	S *	12/2001	Giardiello	D10/32
D508,416	S *	8/2005	Tang	D10/30
D551,095	S *	9/2007	Monachon	D10/32
D589,373	S *	3/2009	Chen	D10/32
D592,977	S *	5/2009	Furetta	D10/32
D608,223	S *	1/2010	Salanitra	D10/38
D632,592	S *	2/2011	Actis-Datta	D10/32

* cited by examiner

Primary Examiner — Lucy Lieberman

(74) *Attorney, Agent, or Firm* — Salter & Michaelson

(57) **CLAIM**

The ornamental design for a watch, as shown and described.

DESCRIPTION

FIG. 1 is a perspective view of a watch;
FIG. 2 is a front elevational view thereof;
FIG. 3 is a rear elevational view thereof;
FIG. 4 is a right side elevational view thereof;
FIG. 5 is a left side elevational view thereof;
FIG. 6 is a top plan view thereof; and,
FIG. 7 is a bottom plan view thereof.
The portions shown in broken lines are included for illustrative purposes only and form no part of the claimed design.

1 Claim, 3 Drawing Sheets

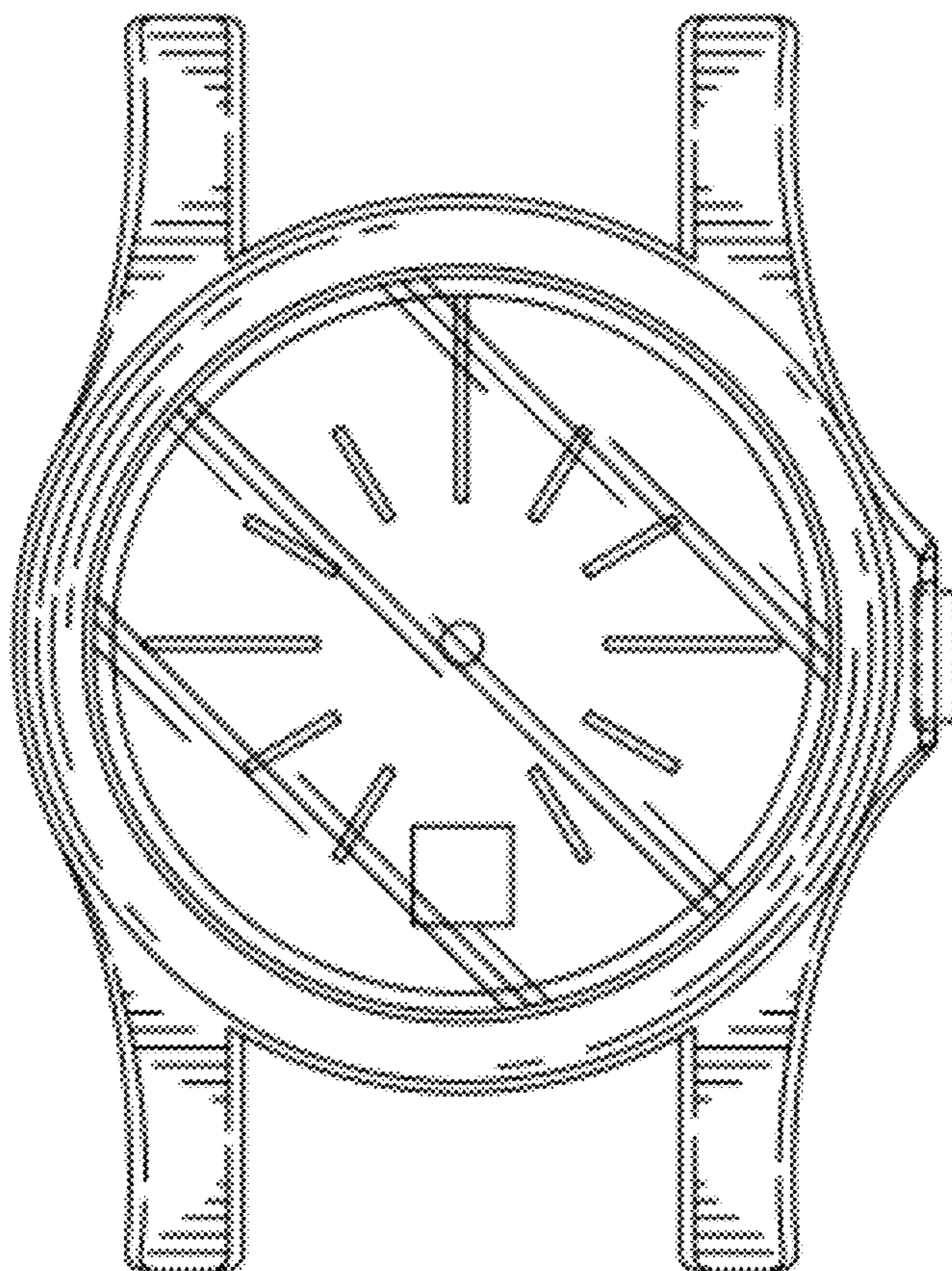

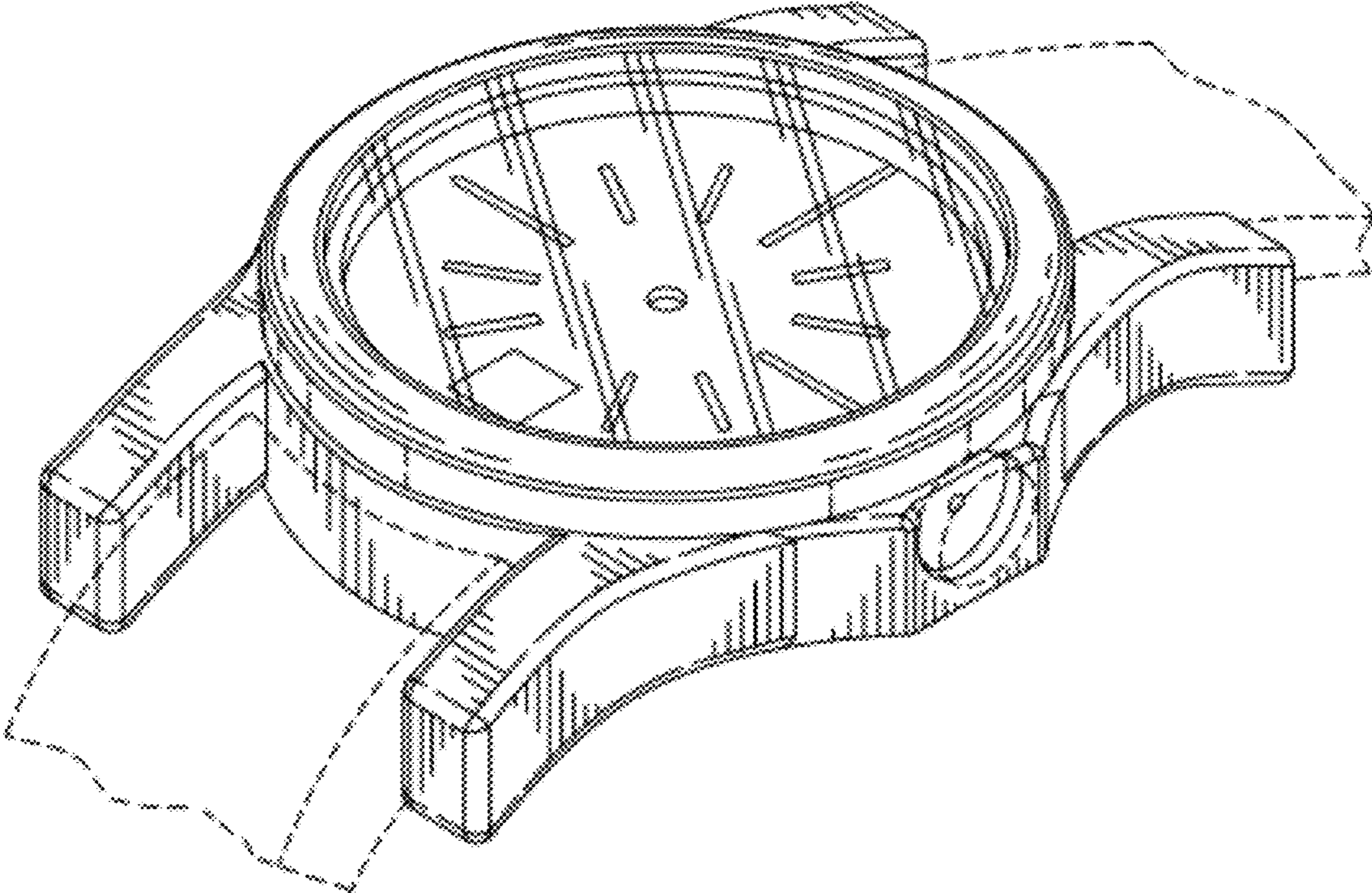

FIG. 1

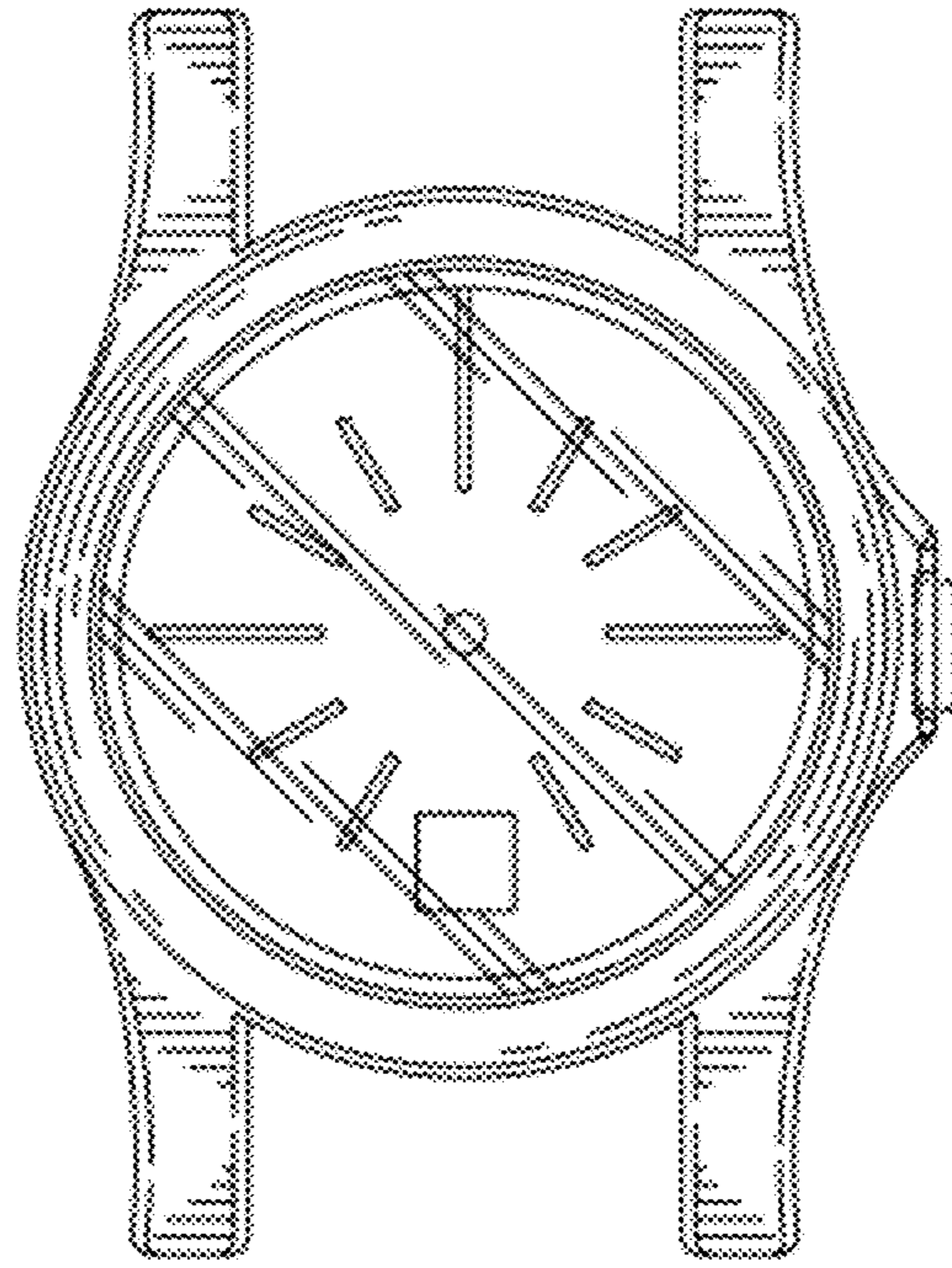

FIG. 2

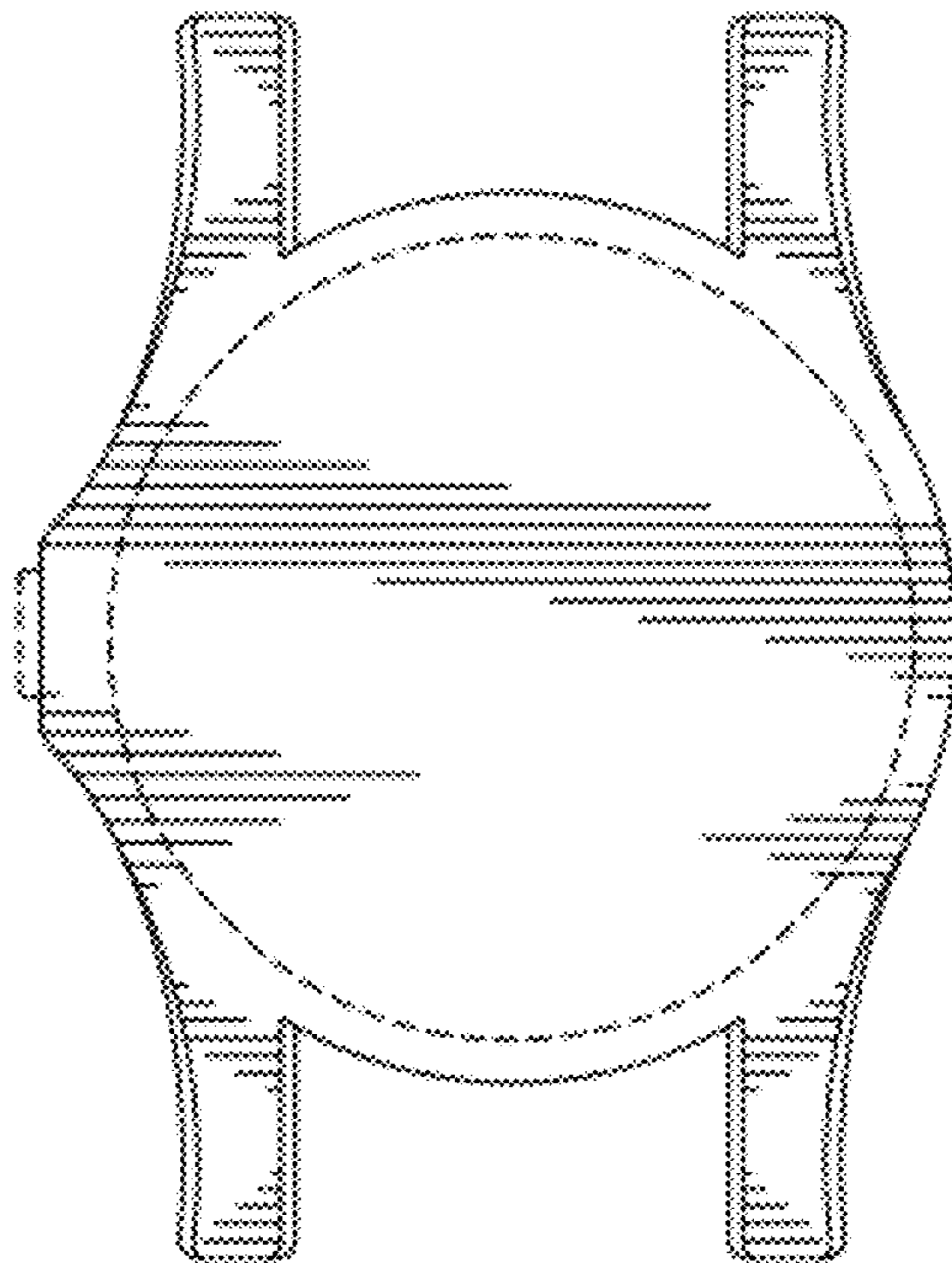

FIG. 3

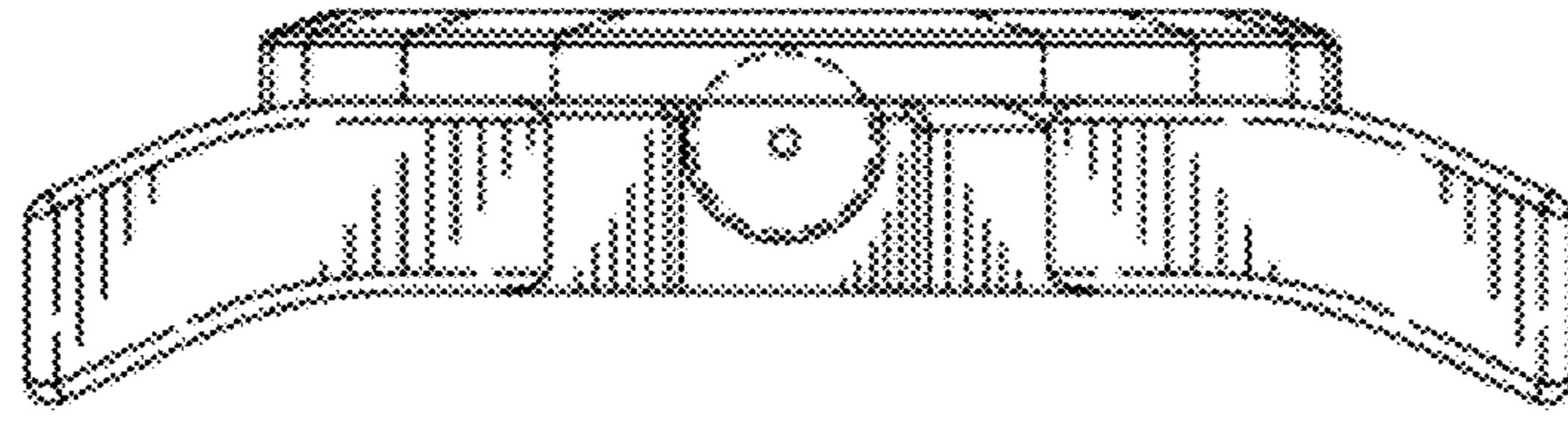

FIG. 4

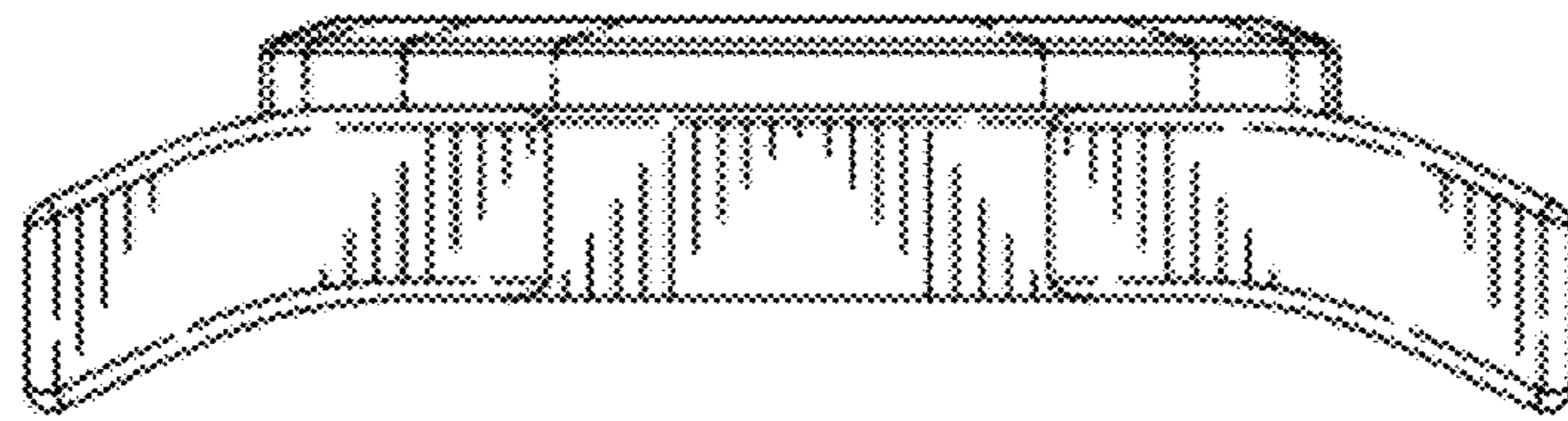

FIG. 5

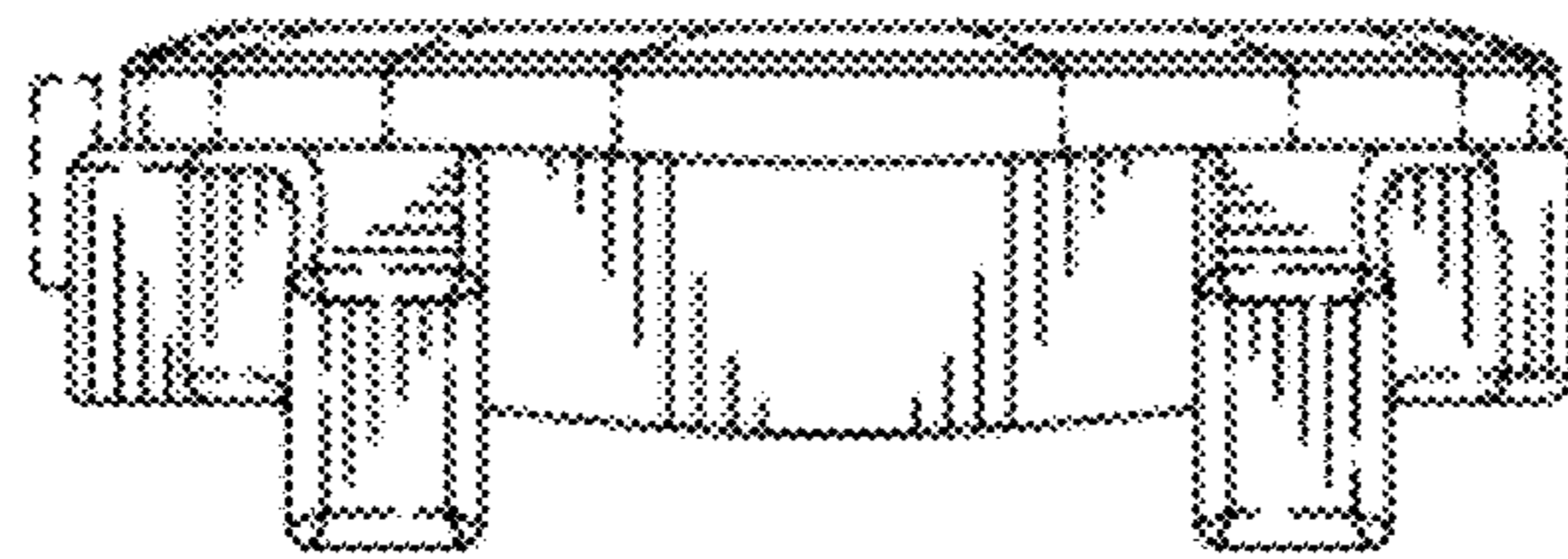

FIG. 6

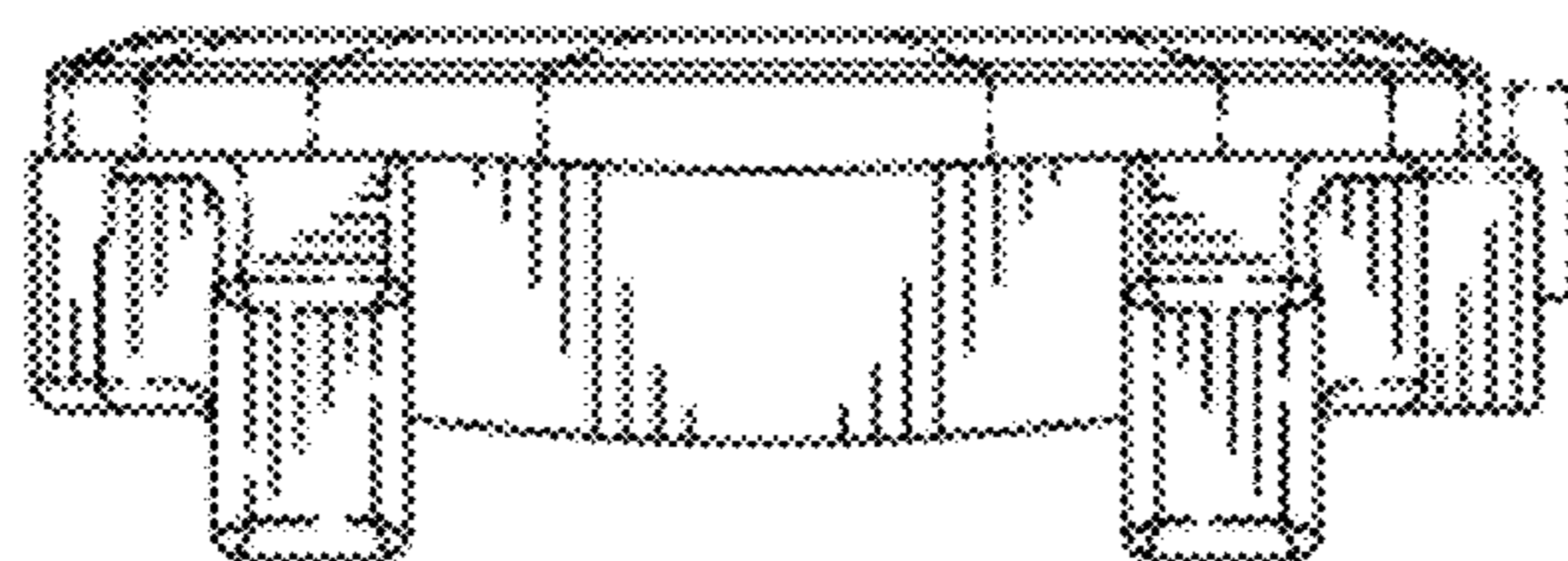

FIG. 7