

US00D667294S

(12) **United States Design Patent**  
**Wang**

(10) **Patent No.:** **US D667,294 S**

(45) **Date of Patent:** **\*\* Sep. 18, 2012**

(54) **HANGING HOOK**

(76) Inventor: **Wen-Tsan Wang**, Taipei (TW)

(\*\*) Term: **14 Years**

(21) Appl. No.: **29/415,152**

(22) Filed: **Mar. 8, 2012**

(51) **LOC (9) Cl.** ..... **08-05**

(52) **U.S. Cl.** ..... **D8/367**

(58) **Field of Classification Search** ..... D8/367,  
D8/354, 349, 373; 248/301, 304, 215

See application file for complete search history.

(56) **References Cited**

**U.S. PATENT DOCUMENTS**

D323,587 S *	2/1992	Primeau	.....	D6/327
D328,240 S *	7/1992	Polski	.....	D8/367
D360,305 S *	7/1995	Moore	.....	D6/328
D427,506 S *	7/2000	Smith	.....	D8/367
D516,900 S *	3/2006	Hoernig	.....	D8/367
D557,124 S *	12/2007	Martinez et al.	.....	D8/380

D618,537 S *	6/2010	Panzer et al.	.....	D8/367
D632,549 S *	2/2011	Williams	.....	D8/367
D635,844 S *	4/2011	Boothby	.....	D8/367

\* cited by examiner

*Primary Examiner* — Cynthia Underwood

(74) *Attorney, Agent, or Firm* — Leong C. Lei

(57) **CLAIM**

The ornamental design for a hanging hook, as shown and described.

**DESCRIPTION**

FIG. 1 is a perspective view of a hanging hook showing my new design;

FIG. 2 is a front elevational view thereof;

FIG. 3 is a rear elevational view thereof;

FIG. 4 is a left side elevational view thereof;

FIG. 5 is a right side elevational view thereof;

FIG. 6 is a top plan view thereof; and,

FIG. 7 is a bottom plan view thereof.

**1 Claim, 4 Drawing Sheets**

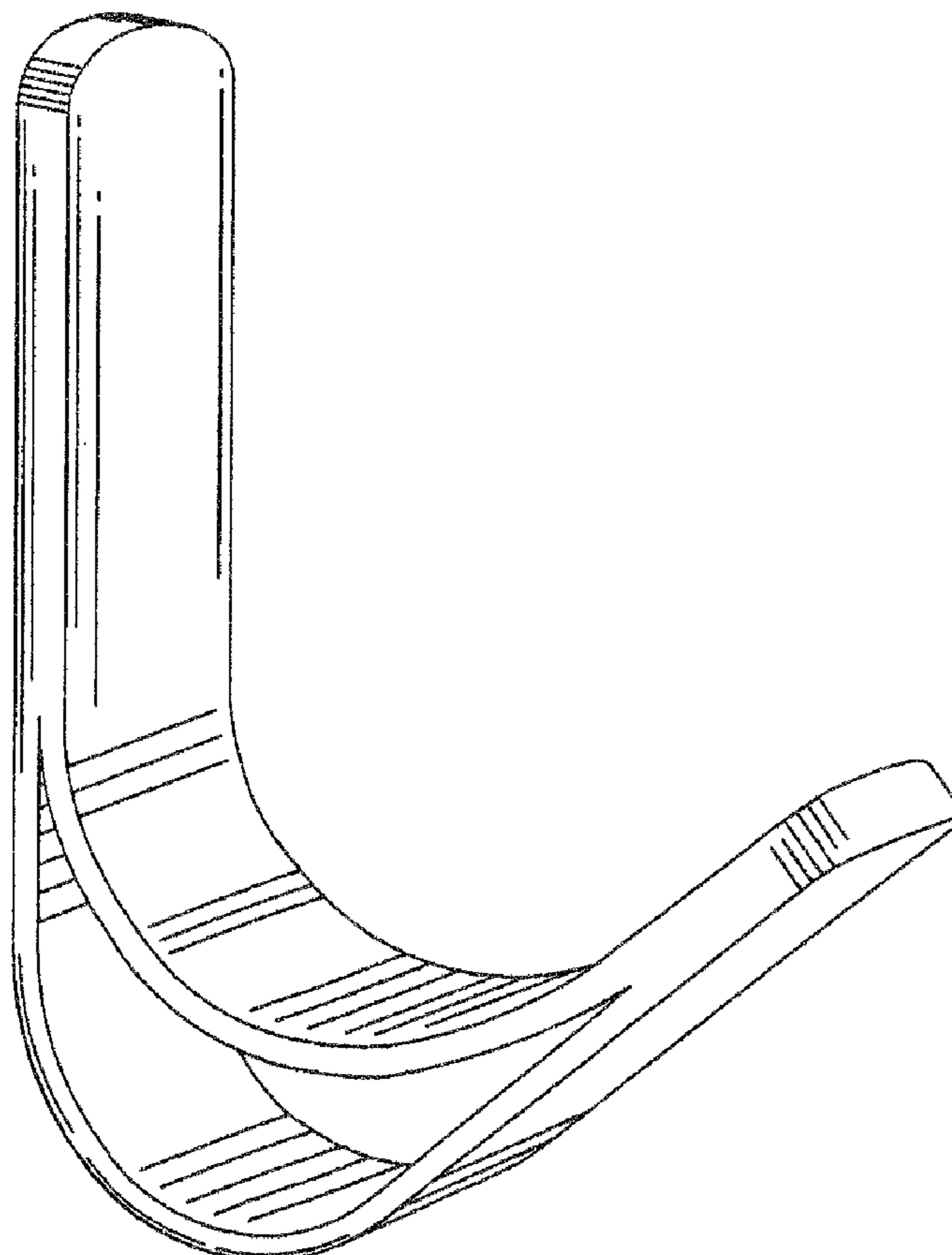

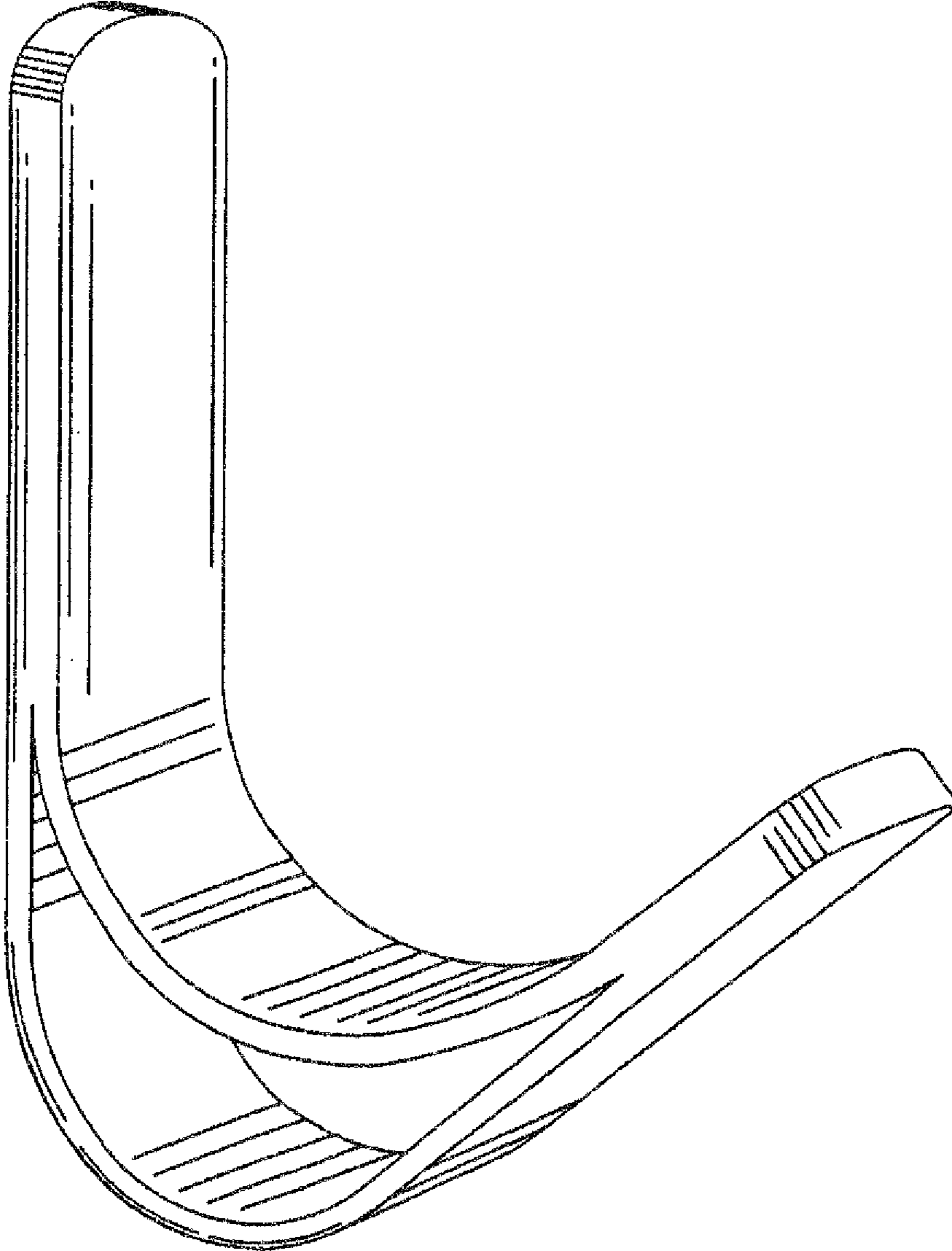

FIG. 1

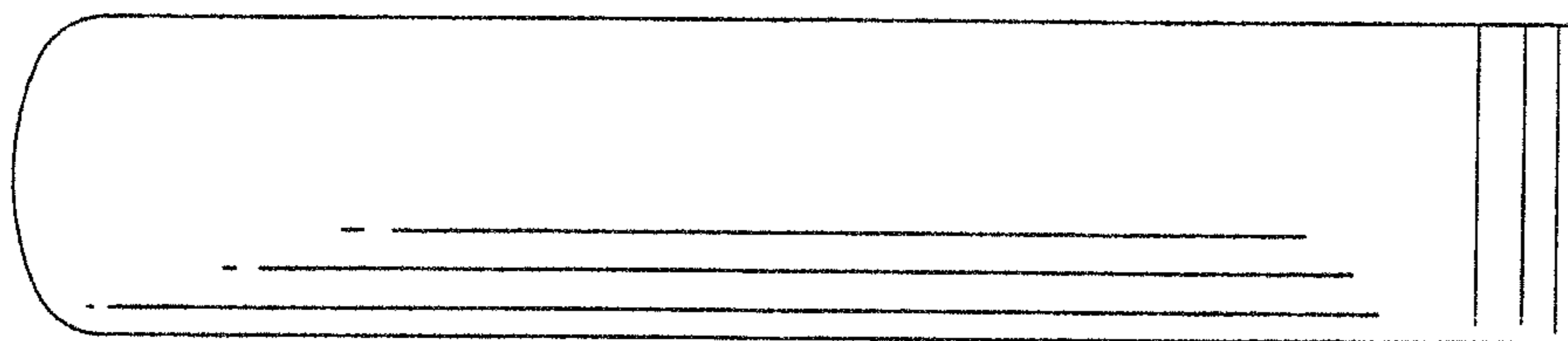

FIG.3

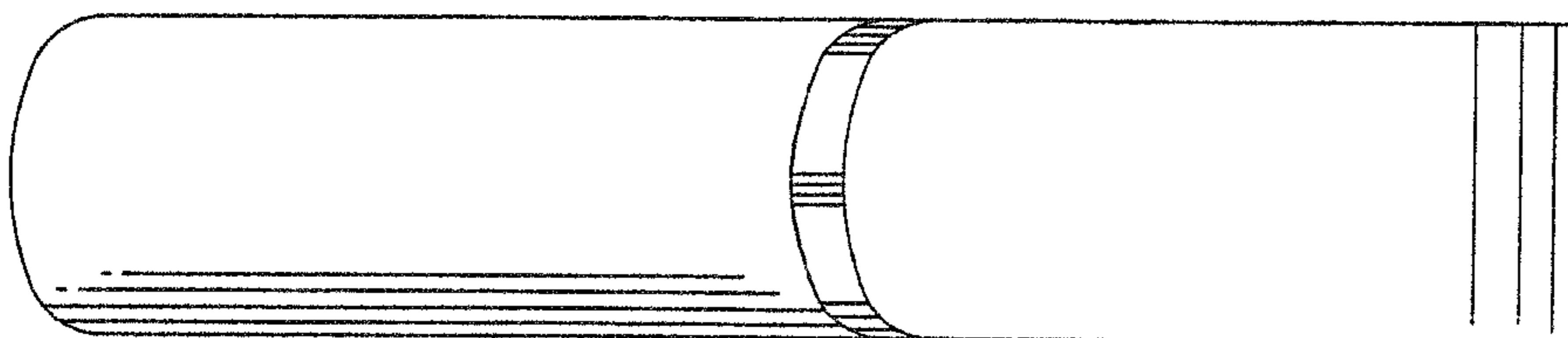

FIG.2

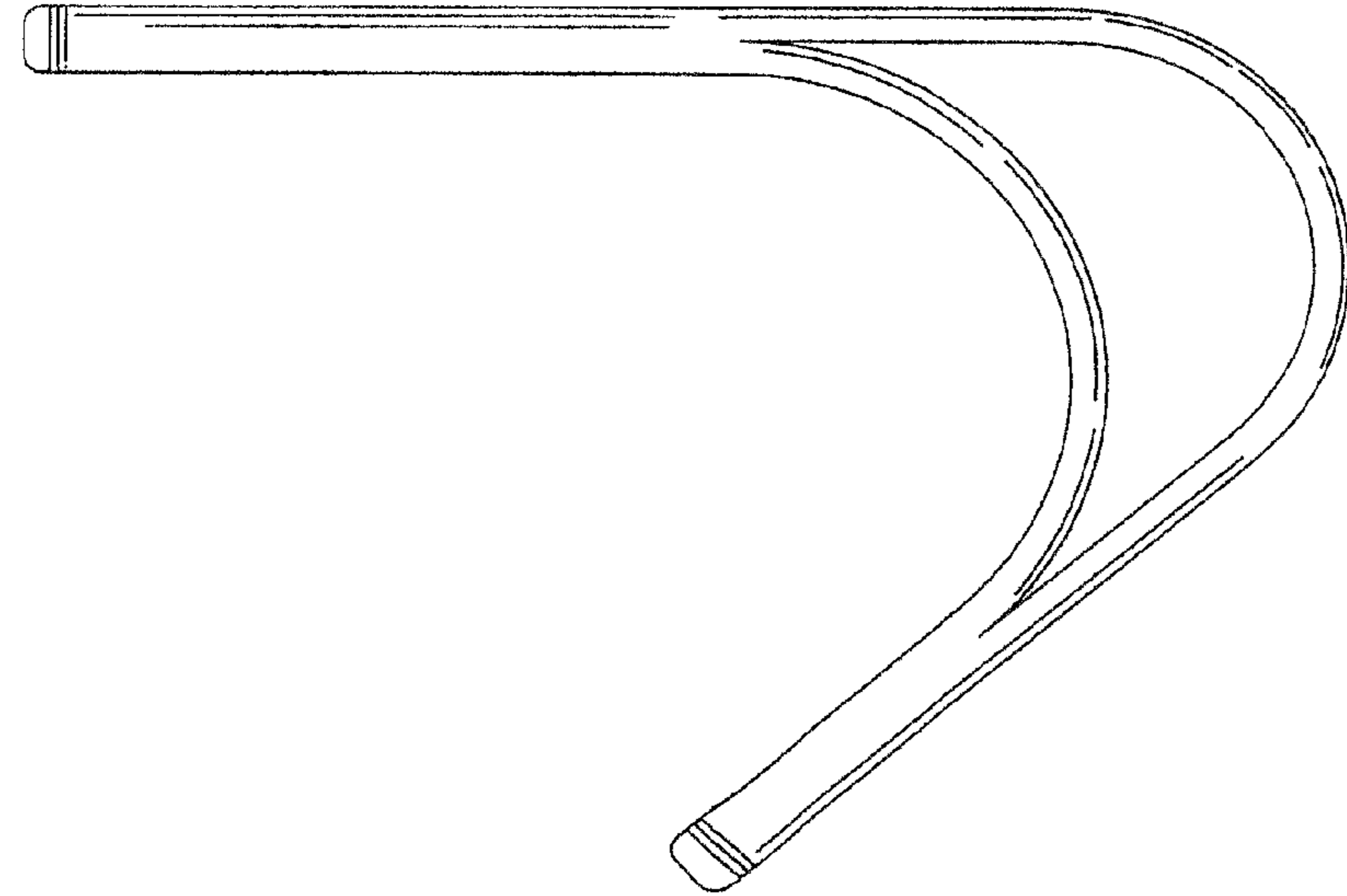

FIG.5

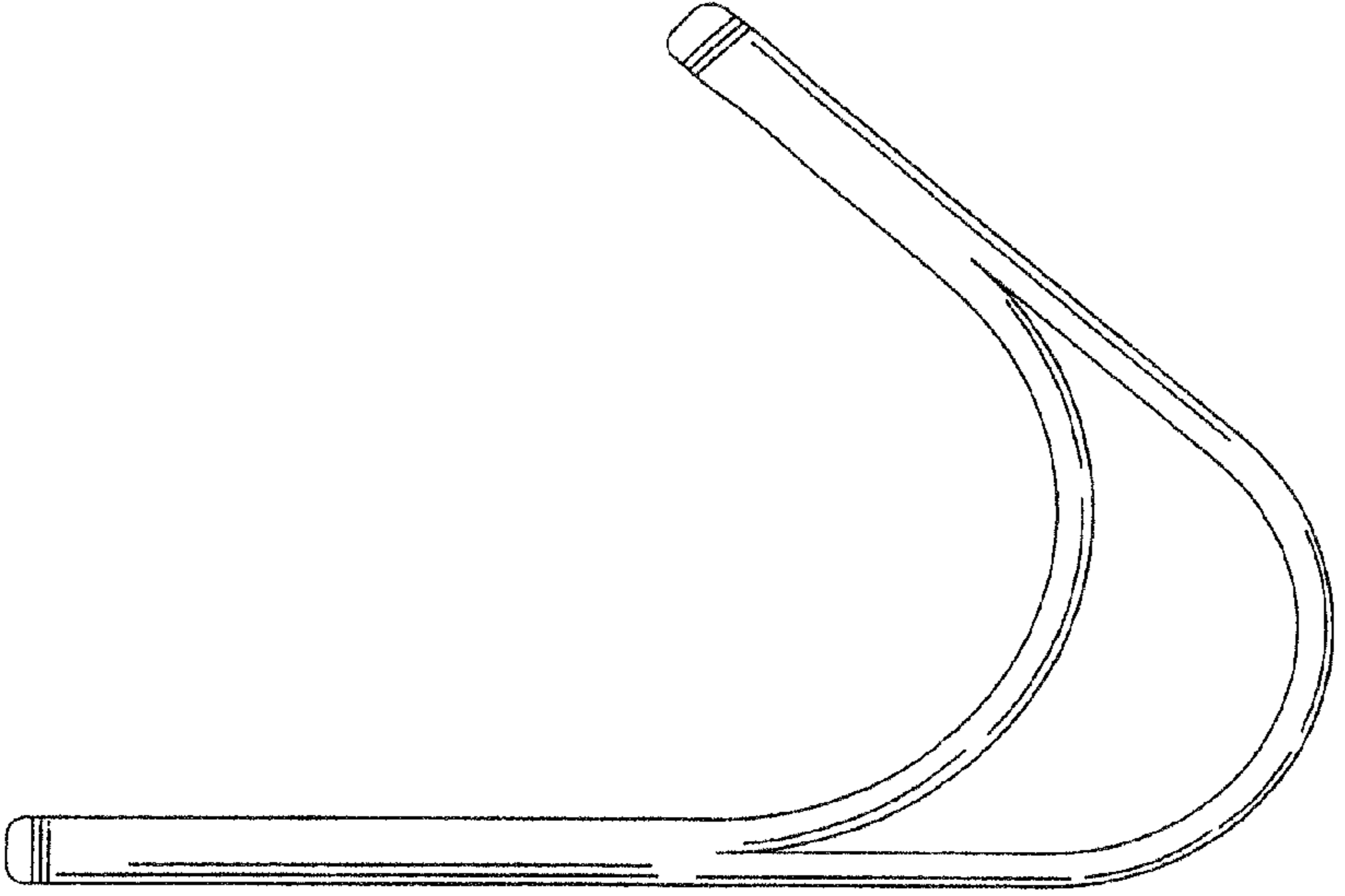

FIG.4

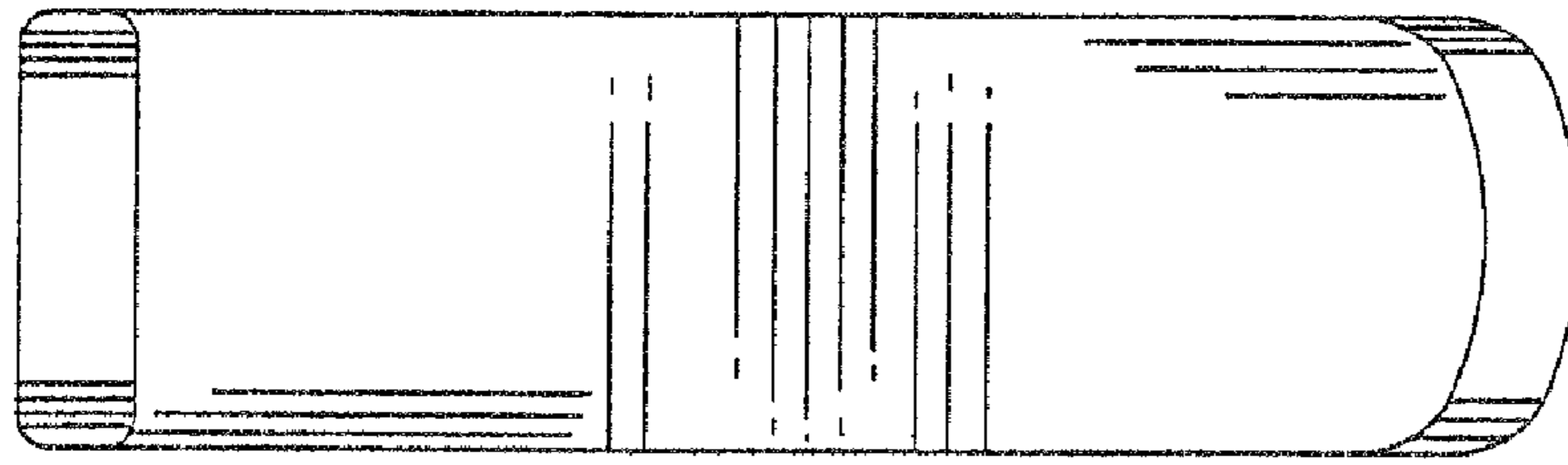

FIG. 6

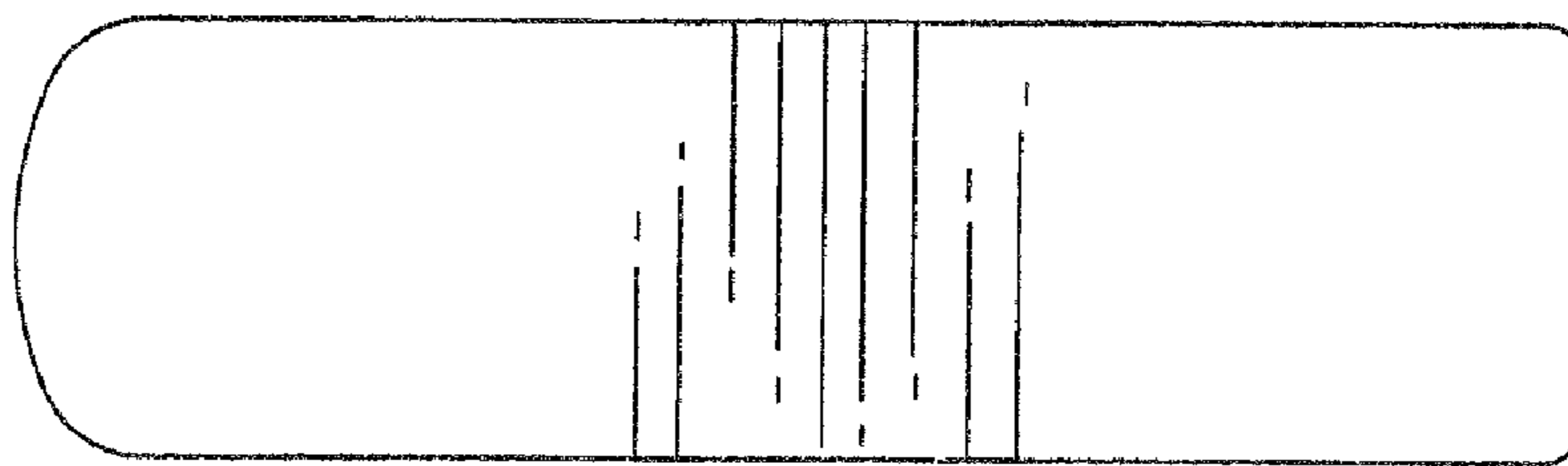

FIG. 7