

US00D667124S

(12) **United States Design Patent**
Takemoto

(10) **Patent No.:** **US D667,124 S**

(45) **Date of Patent:** **** Sep. 11, 2012**

(54) **EARPHONE FOR HEARING AID**
(75) Inventor: **Masaki Takemoto**, Ehime (JP)
(73) Assignee: **Panasonic Corporation**, Osaka (JP)
(**) Term: **14 Years**
(21) Appl. No.: **29/404,543**
(22) Filed: **Oct. 21, 2011**

D635,678 S * 4/2011 Laperle et al. D24/174
D639,283 S * 6/2011 Ozawa et al. D14/223
D641,011 S * 7/2011 Gondo D14/206
D644,213 S * 8/2011 Quek D14/223
D656,491 S * 3/2012 Nomura D14/223

FOREIGN PATENT DOCUMENTS

JP D1357231 4/2009
JP D1357232 4/2009
JP D1371612 10/2009
JP D1371613 10/2009

* cited by examiner

(30) **Foreign Application Priority Data**

May 12, 2011 (JP) 2011-010570

(51) **LOC (9) Cl.** **24-99**
(52) **U.S. Cl.** **D24/174**
(58) **Field of Classification Search** D24/173-175,
D24/151; D14/205, 223, 224, 249, 206,
D14/225, 226; 381/23.1, 312, 322-324,
381/328, 330, 380, 381; 181/135

See application file for complete search history.

Primary Examiner — Anhdao Doan

(74) *Attorney, Agent, or Firm* — Brinks Hofer Gilson & Lione

(57) **CLAIM**

I claim the ornamental design for an earphone for hearing aid, as shown and described.

DESCRIPTION

FIG. 1 is a front perspective view of an earphone for hearing aid of the present invention;
FIG. 2 is a rear perspective view thereof;
FIG. 3 is a front view thereof;
FIG. 4 is a rear view thereof;
FIG. 5 is a first side view thereof;
FIG. 6 is a second side view thereof;
FIG. 7 is a top view thereof; and,
FIG. 8 is a bottom view thereof.

(56) **References Cited**

U.S. PATENT DOCUMENTS

D377,796 S * 2/1997 Hayashi D14/206
D497,001 S * 10/2004 Narisawa et al. D24/174
D554,756 S * 11/2007 Sjursen et al. D24/174
D575,768 S * 8/2008 Wang D14/206
D603,516 S 11/2009 Mori et al.
D604,419 S 11/2009 Mori et al.
D634,306 S * 3/2011 Pedersen D14/223

1 Claim, 8 Drawing Sheets

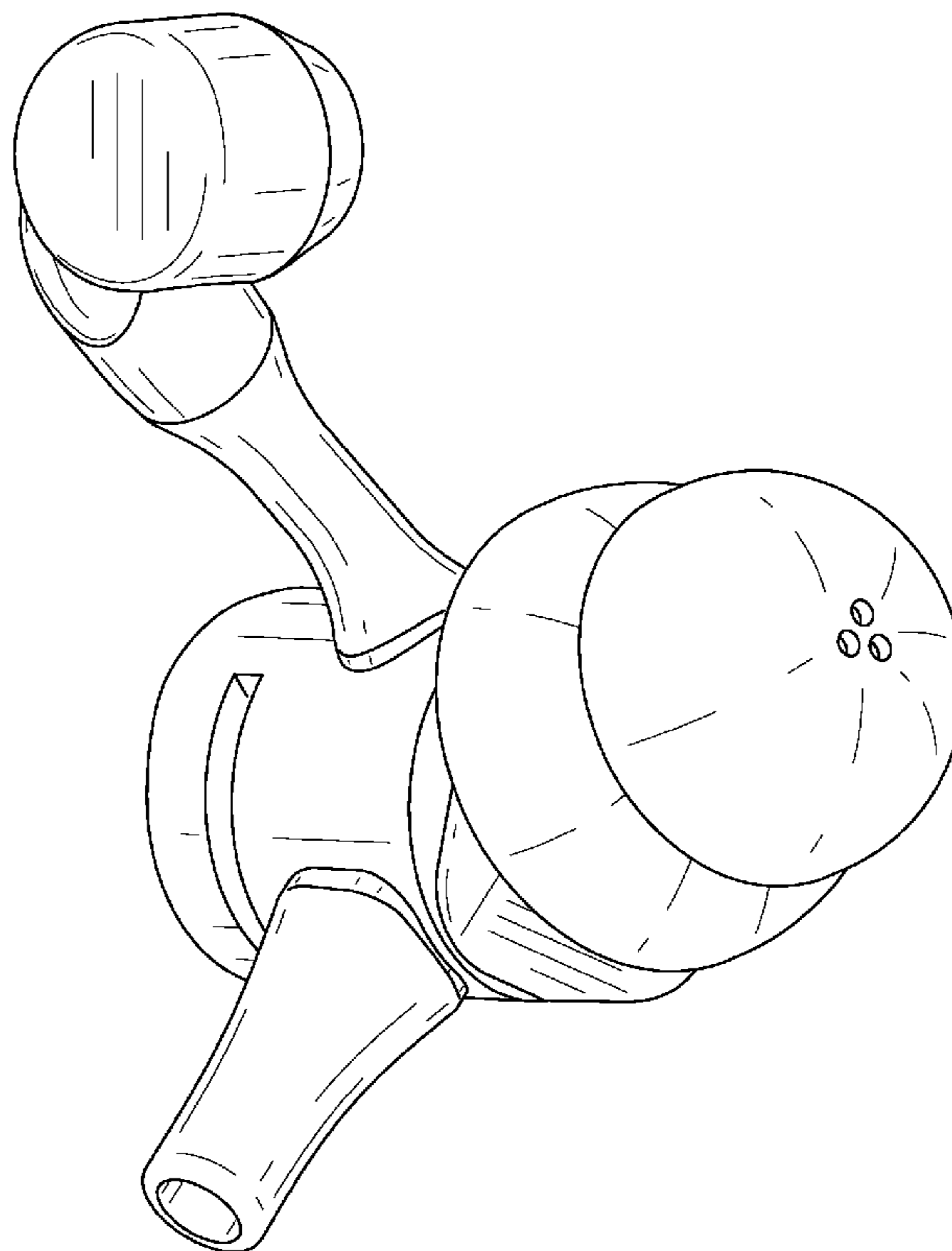

FIG.1

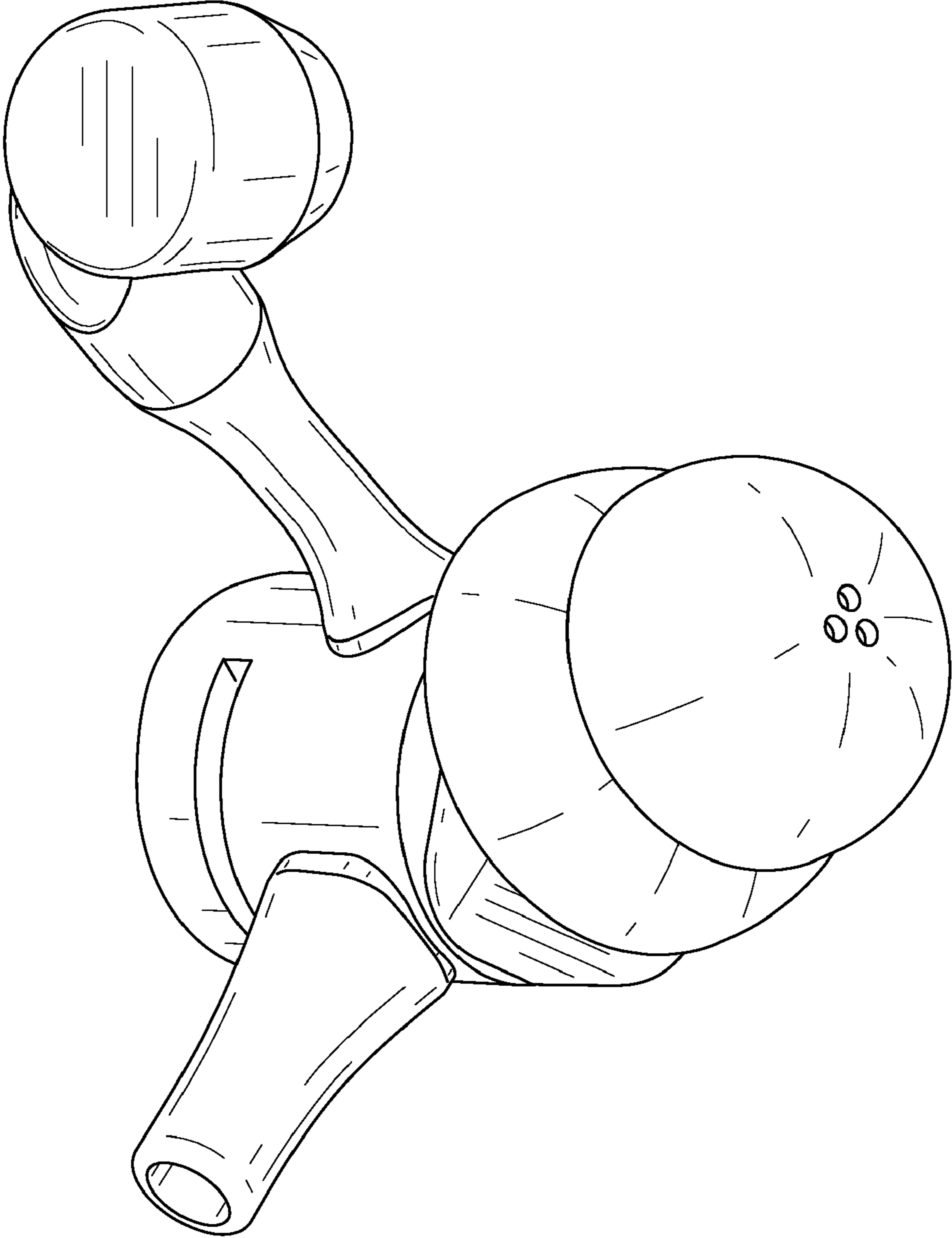

FIG.2

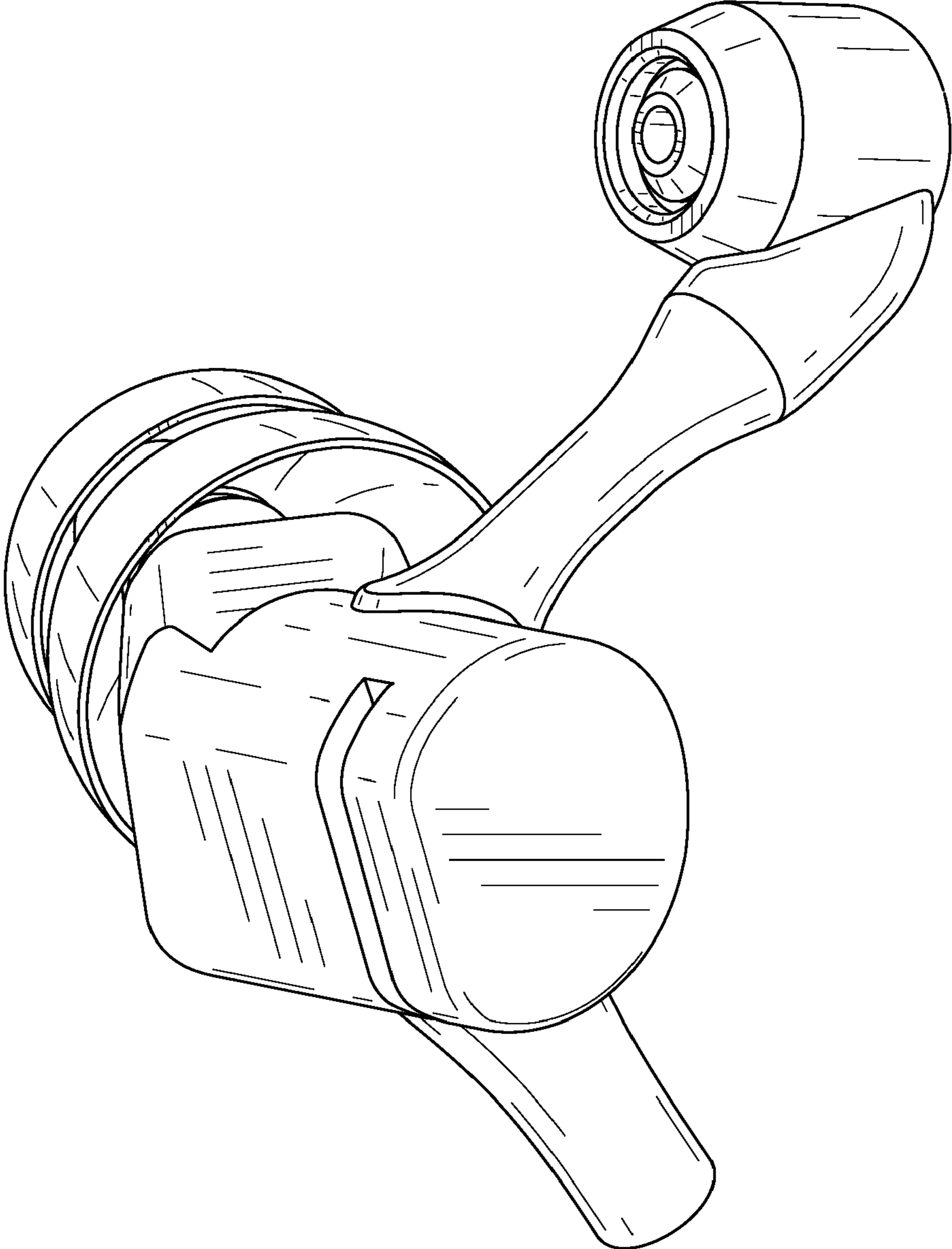

FIG.3

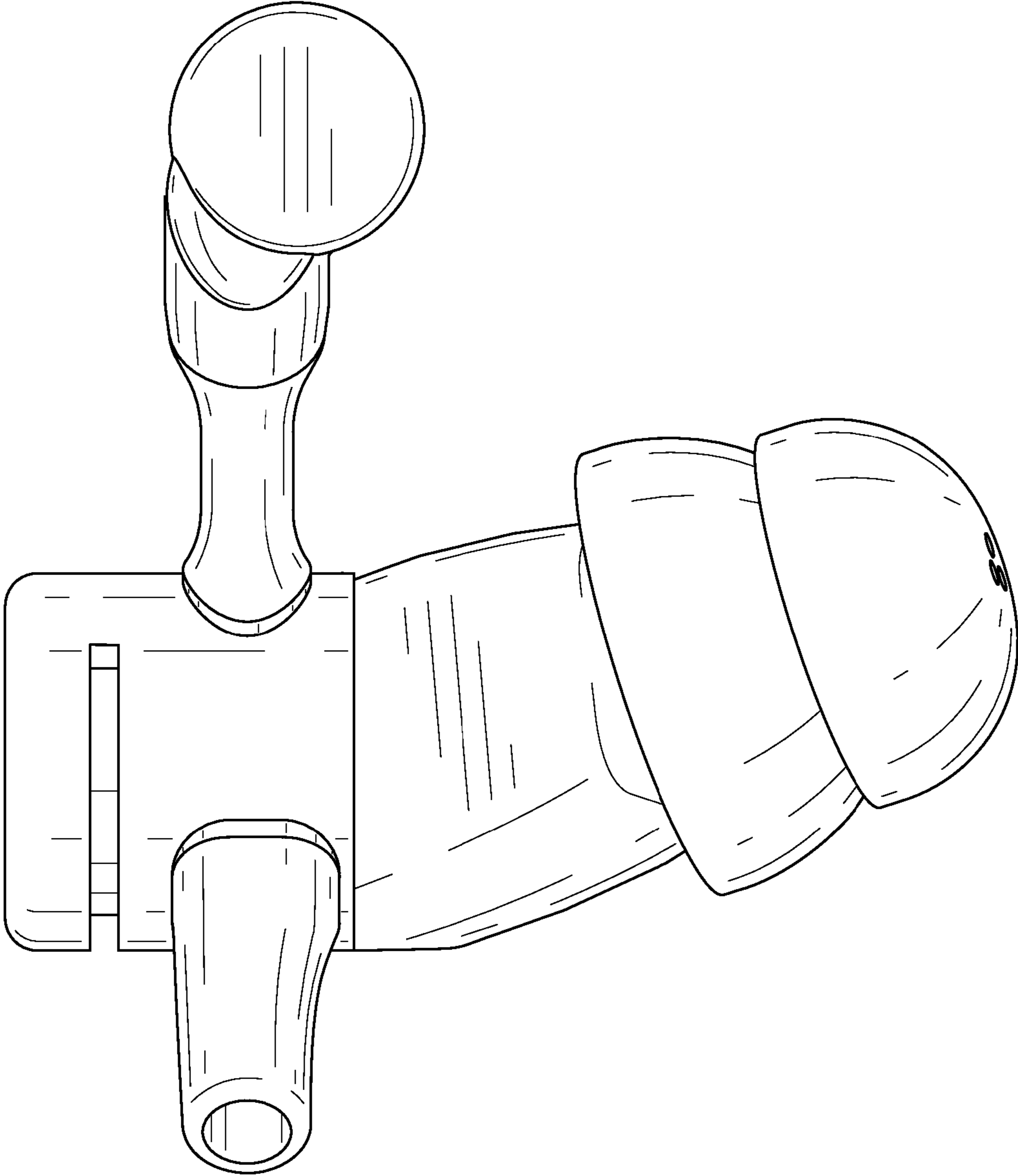

FIG.4

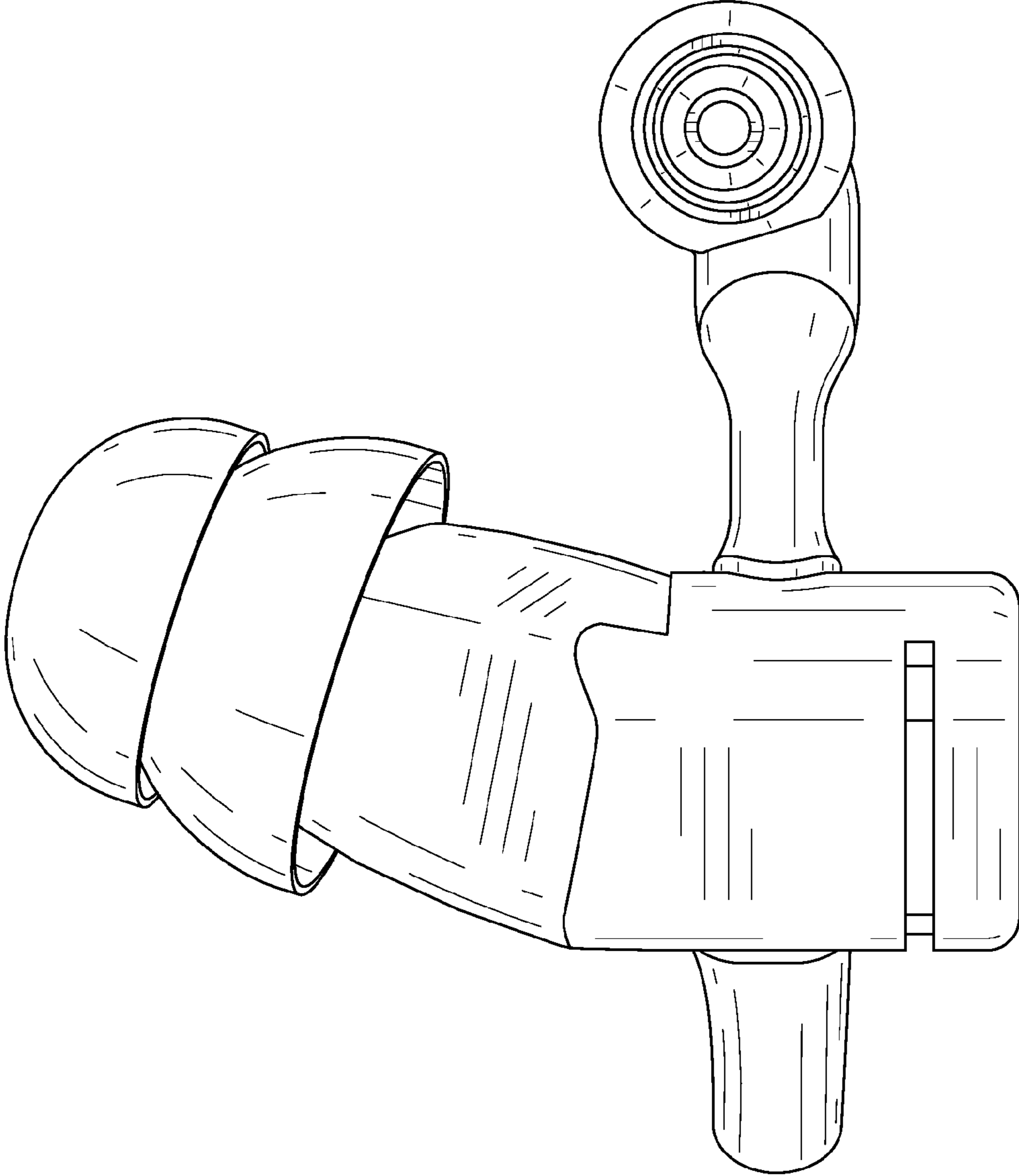

FIG.5

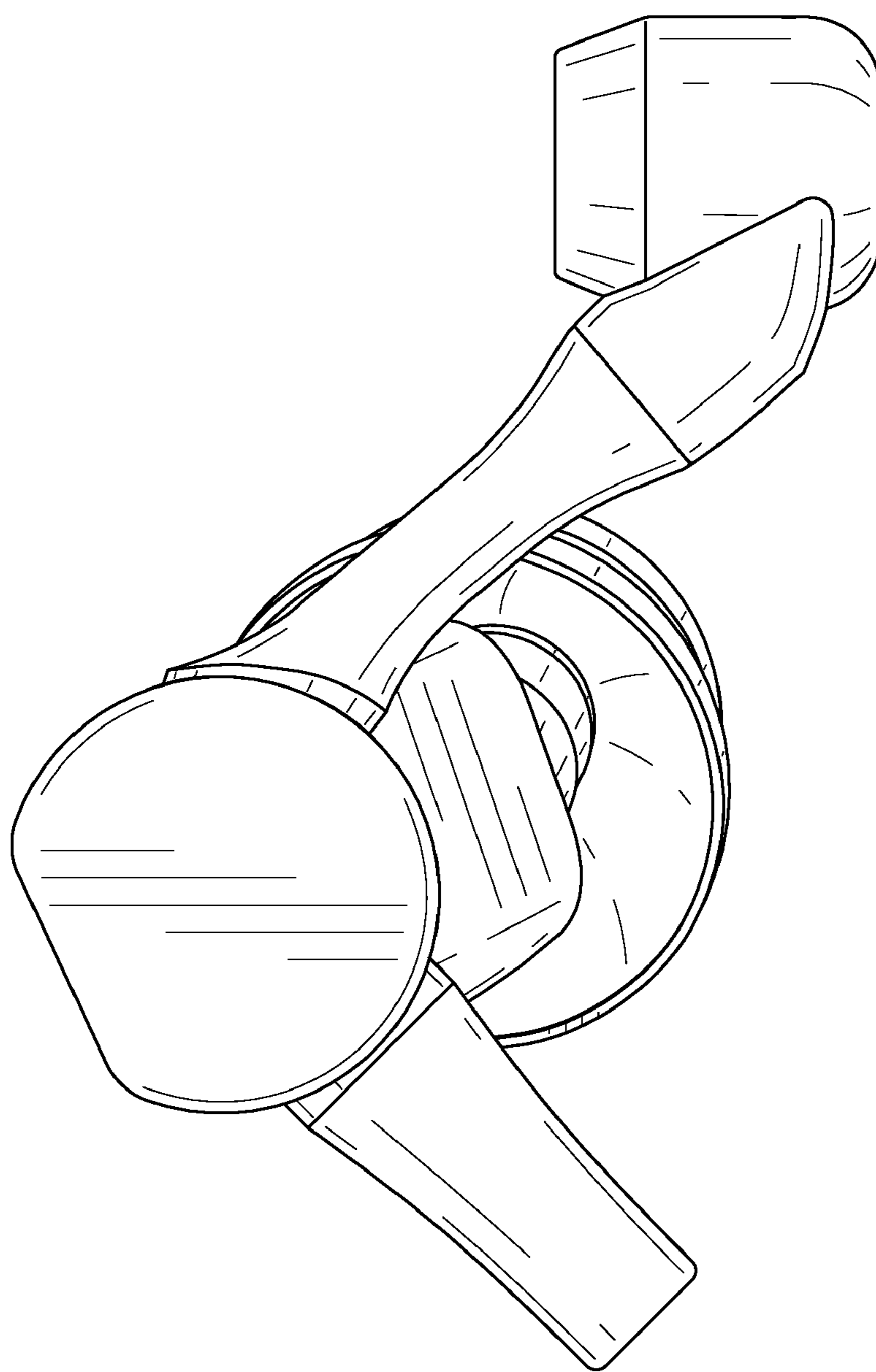

FIG.6

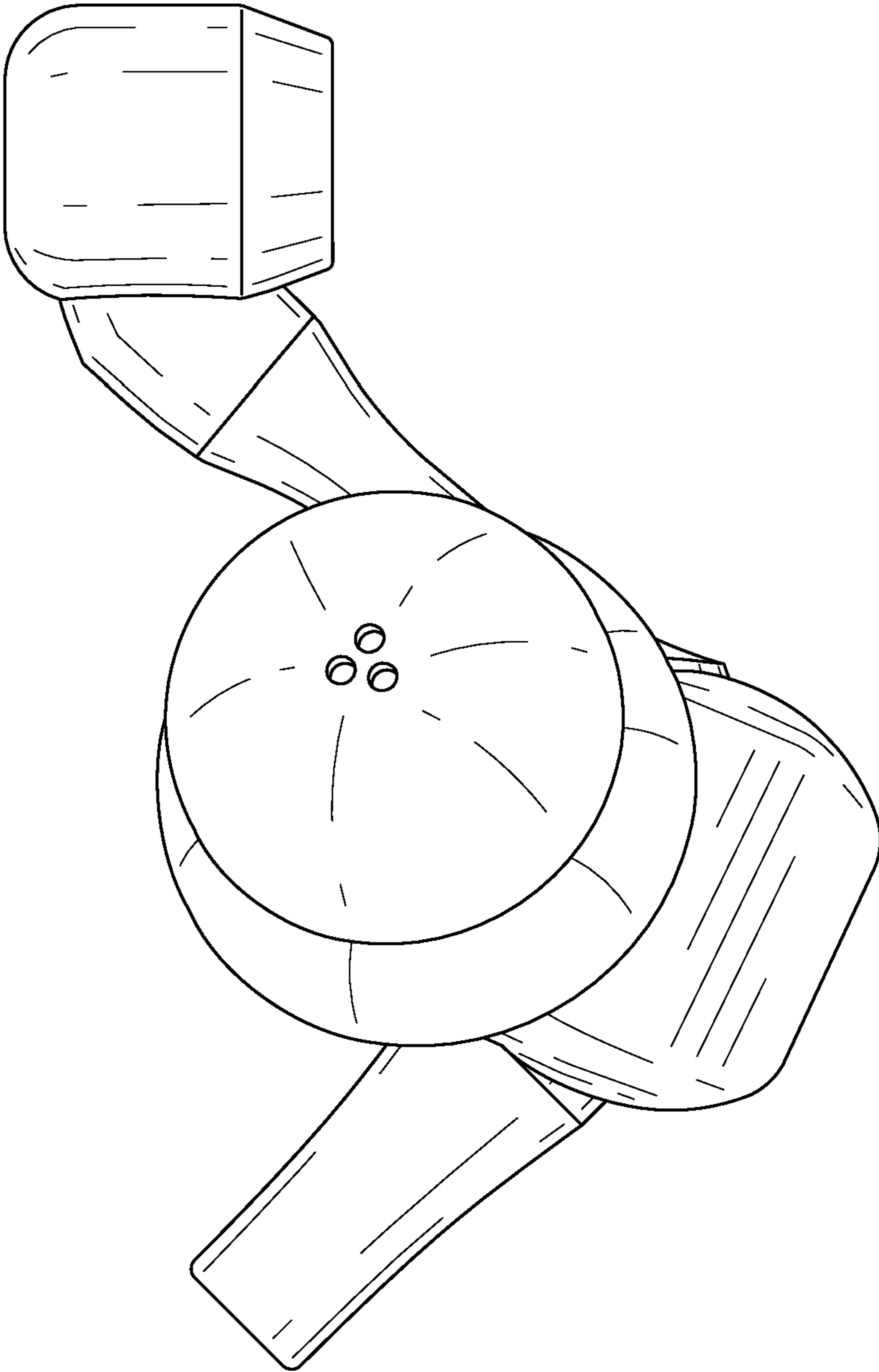

FIG. 7

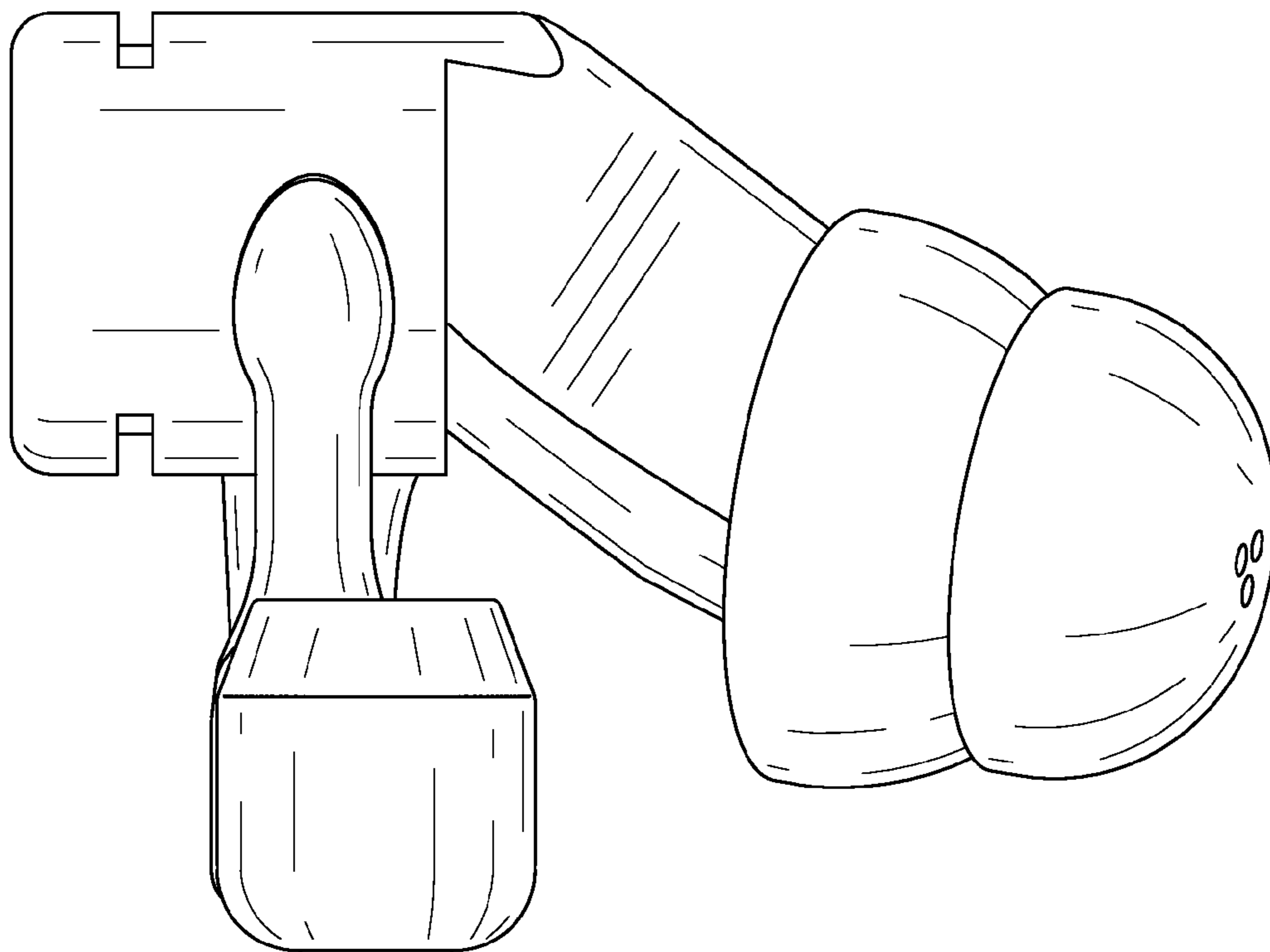

FIG.8

