



US00D667050S

(12) **United States Design Patent**
Takeuchi

(10) **Patent No.:** **US D667,050 S**

(45) **Date of Patent:** **** Sep. 11, 2012**

(54) **PRINTER**

(75) Inventor: **Nobuhiro Takeuchi**, Yokohama (JP)

(73) Assignee: **Canon Kabushiki Kaisha**, Tokyo (JP)

(**) Term: **14 Years**

(21) Appl. No.: **29/394,015**

(22) Filed: **Jun. 13, 2011**

(30) **Foreign Application Priority Data**

Dec. 22, 2010 (JP) 2010-030575

(51) **LOC (9) Cl.** **14-02**

(52) **U.S. Cl.** **D18/50**

(58) **Field of Classification Search** D18/19,
D18/36-37, 50, 54, 54.1, 55; D14/420-425,
D14/463, 470; 400/613, 613.1-613.4, 690,
400/690.1-690.4, 691-694
See application file for complete search history.

(56) **References Cited**

U.S. PATENT DOCUMENTS

D501,503 S * 2/2005 Leong et al. D18/55

D536,373 S * 2/2007 Inoue et al. D18/55

D548,777 S 8/2007 Matsumoto et al. D18/55
D553,184 S * 10/2007 Lee et al. D18/50
D579,489 S * 10/2008 Kanno et al. D18/50
D607,925 S * 1/2010 Morrison et al. D18/50
D614,234 S * 4/2010 Ishikawa et al. D18/55
D641,395 S * 7/2011 Park et al. D18/55
D643,462 S * 8/2011 Yamashita et al. D18/50
D648,379 S * 11/2011 Ishikawa et al. D18/50

* cited by examiner

Primary Examiner — Cathy A MacCormac

(74) *Attorney, Agent, or Firm* — Fitzpatrick, Cella, Harper & Scinto

(57) **CLAIM**

The ornamental design for a printer, as shown and described.

DESCRIPTION

FIG. 1 is a front view of a printer showing my new design;
FIG. 2 is a rear view thereof;
FIG. 3 is a top plan view thereof;
FIG. 4 is a bottom plan view thereof;
FIG. 5 is a left side view thereof;
FIG. 6 is a right side view thereof; and,
FIG. 7 is a perspective view thereof.
The broken lines are for illustration only and form no part of the claimed design.

1 Claim, 7 Drawing Sheets

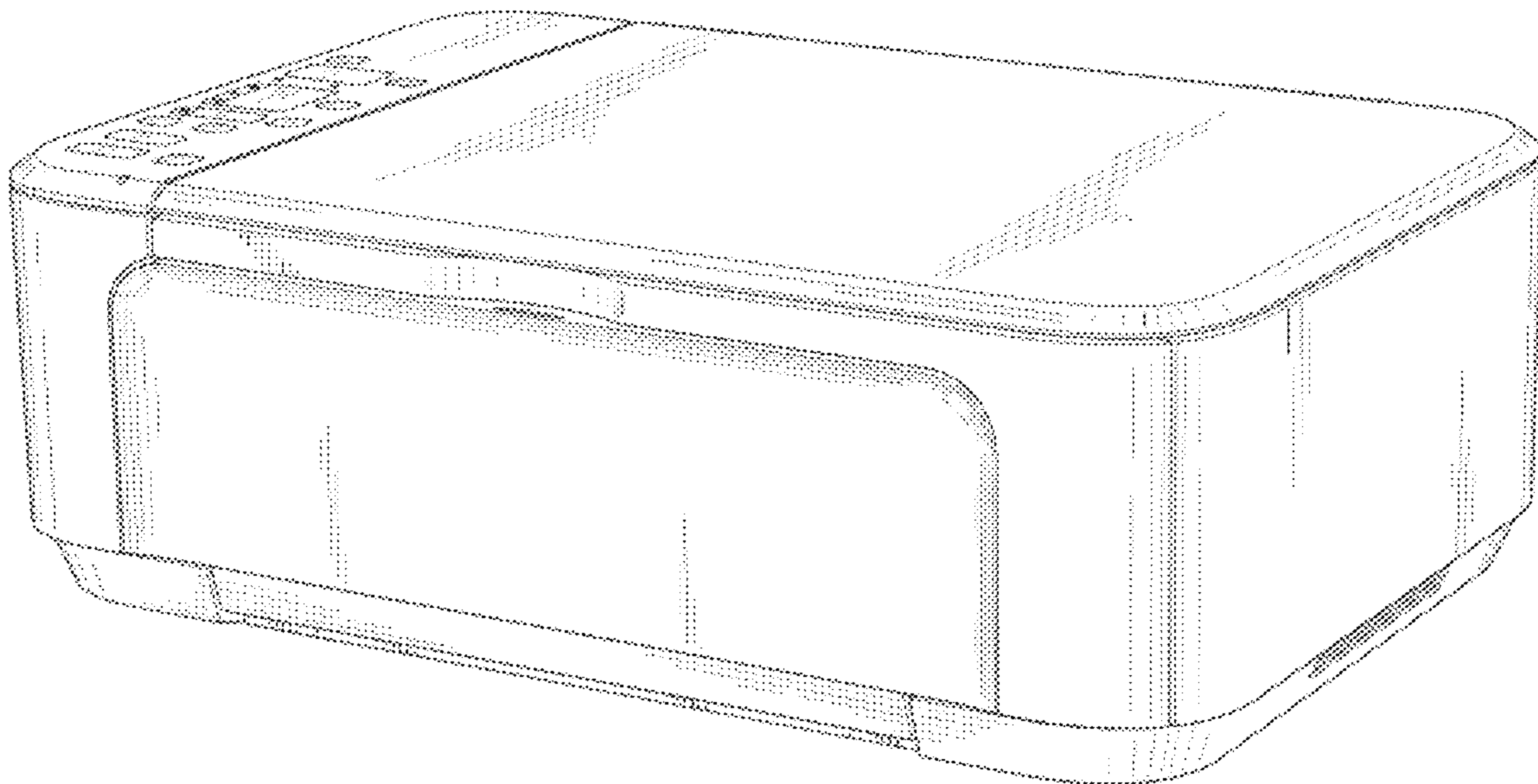

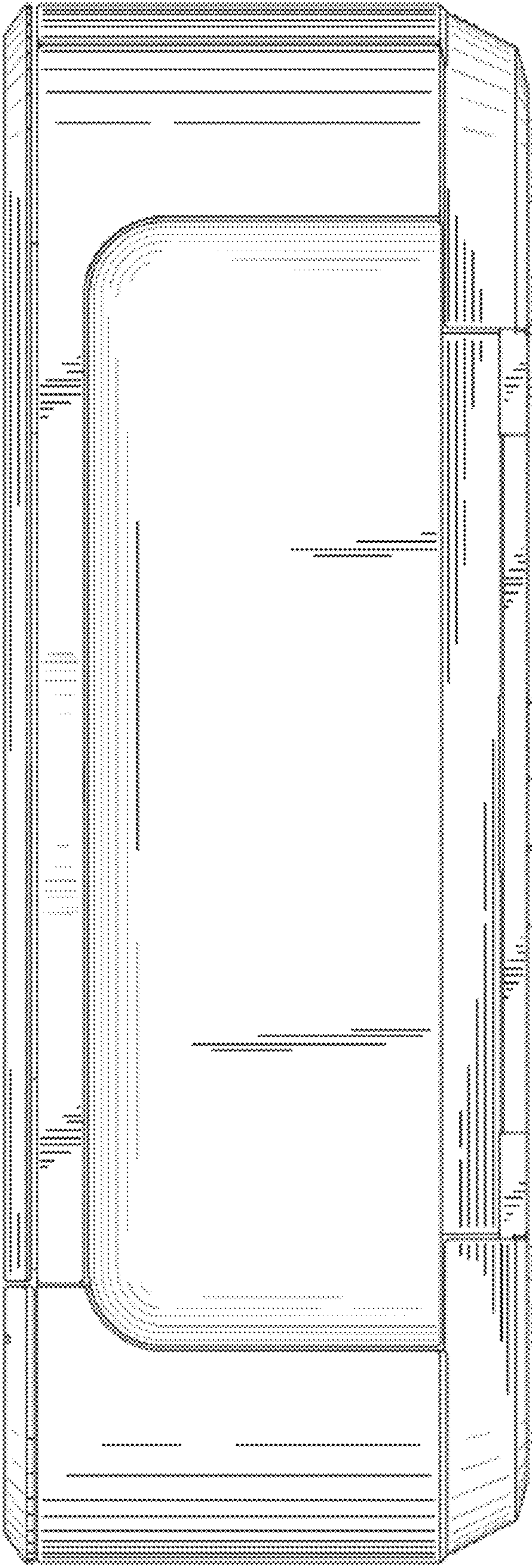

FIG. 1

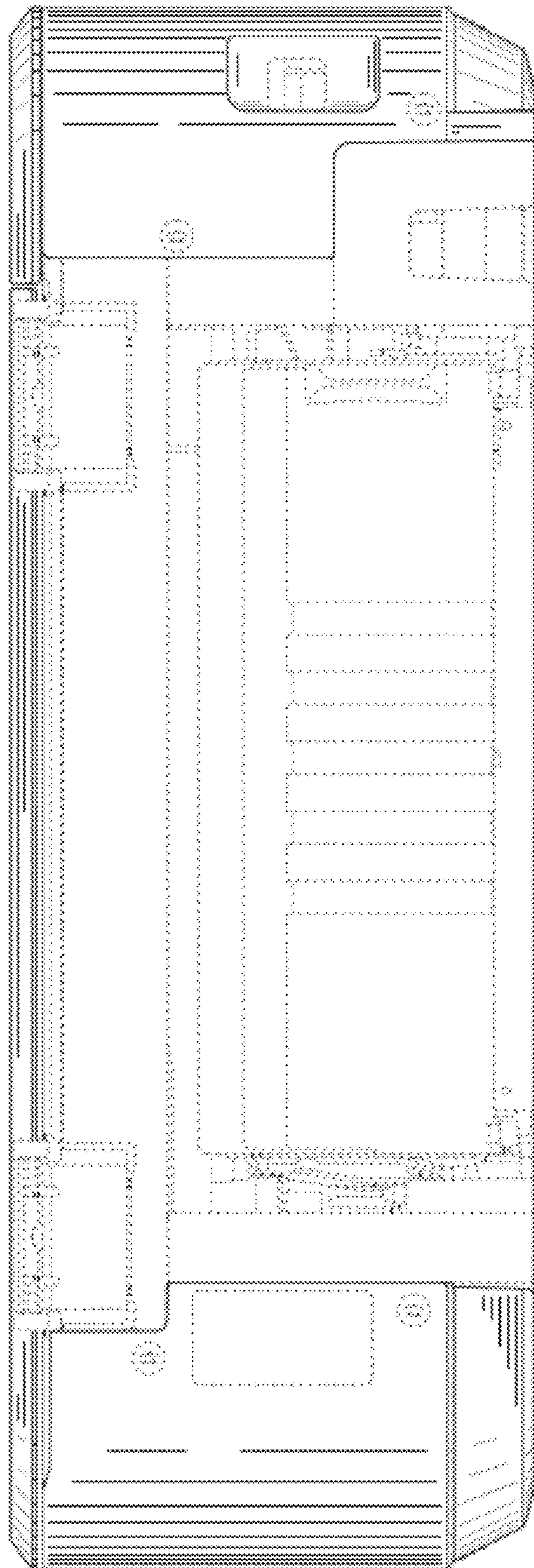

FIG. 2

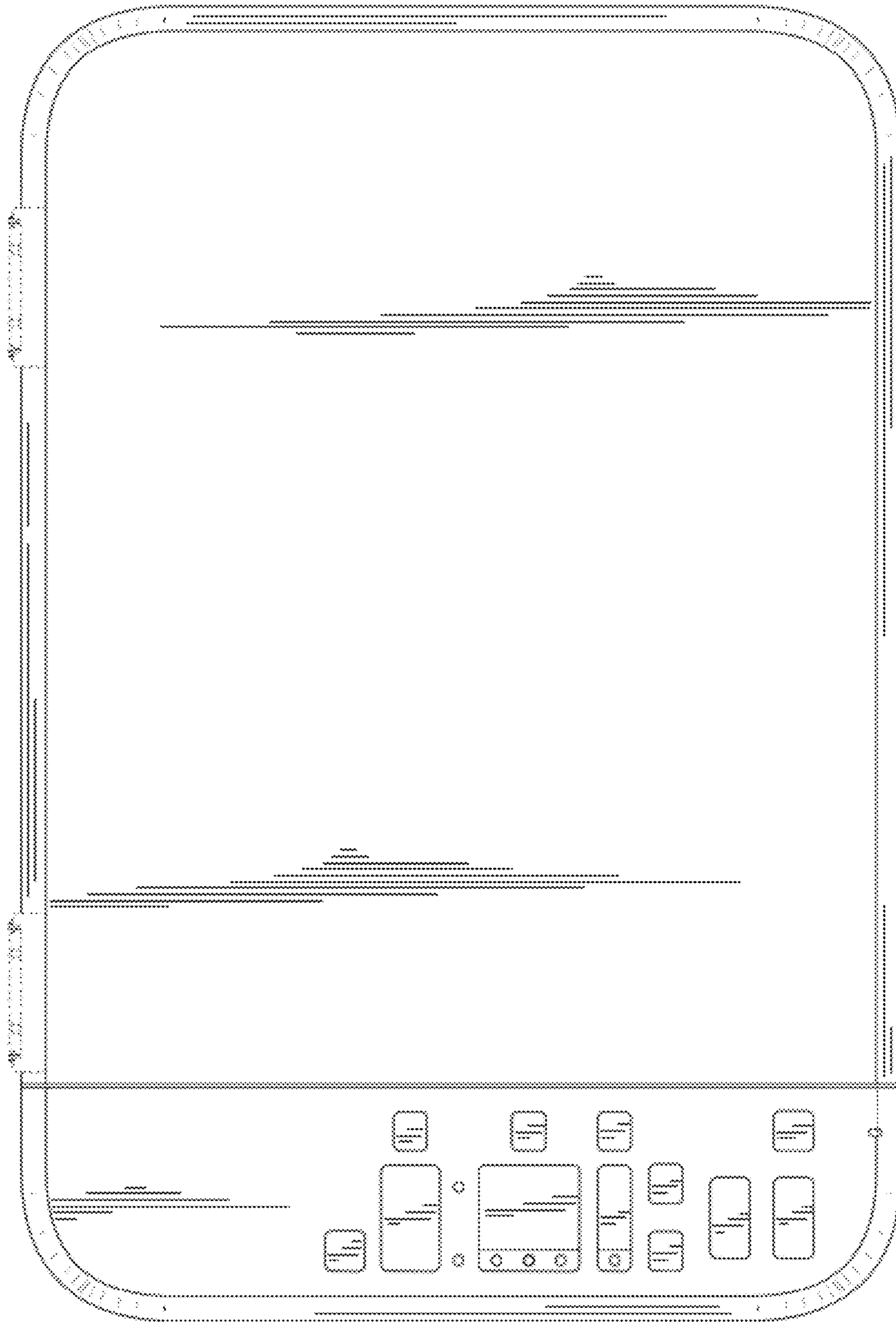

FIG. 3

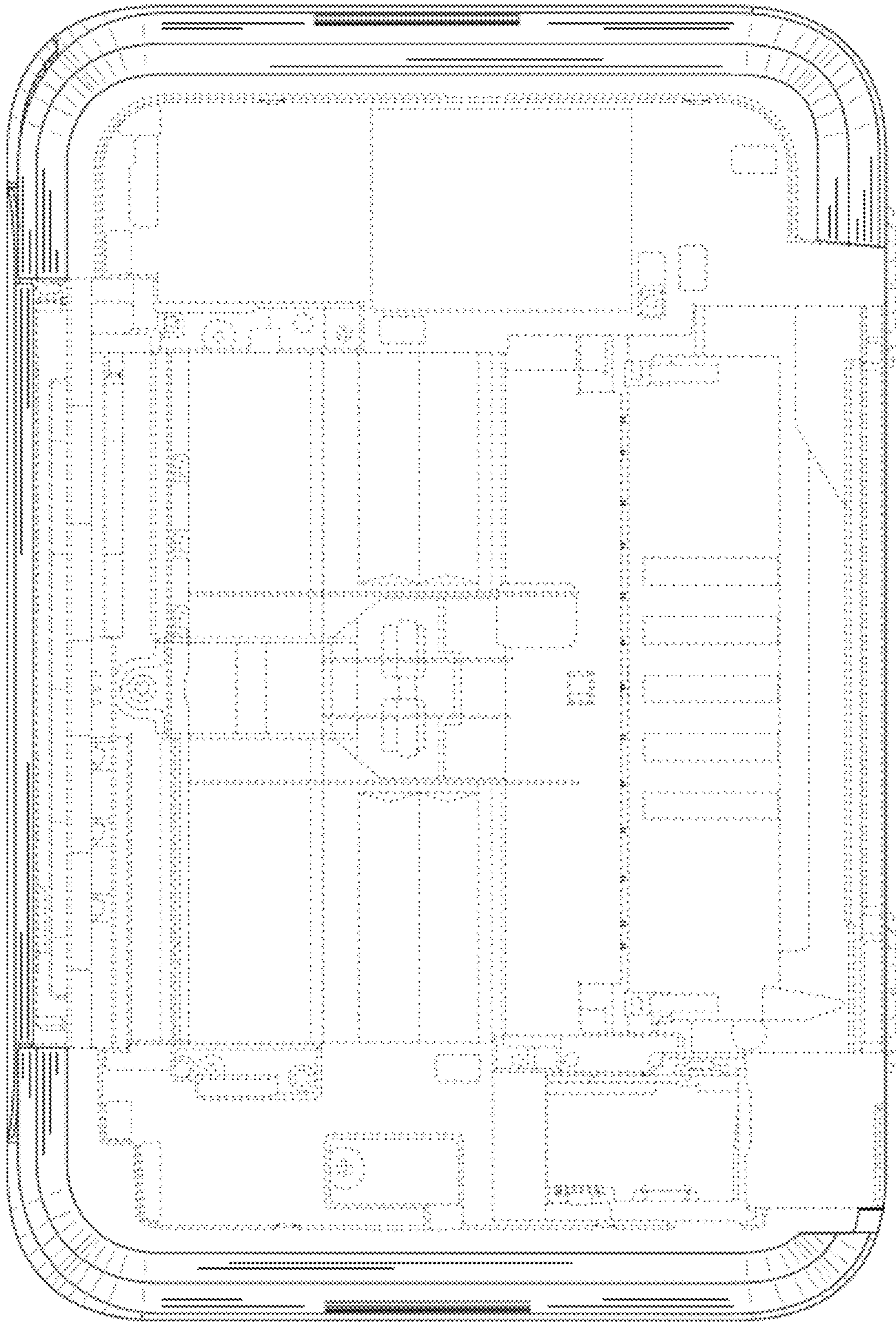

FIG. 4

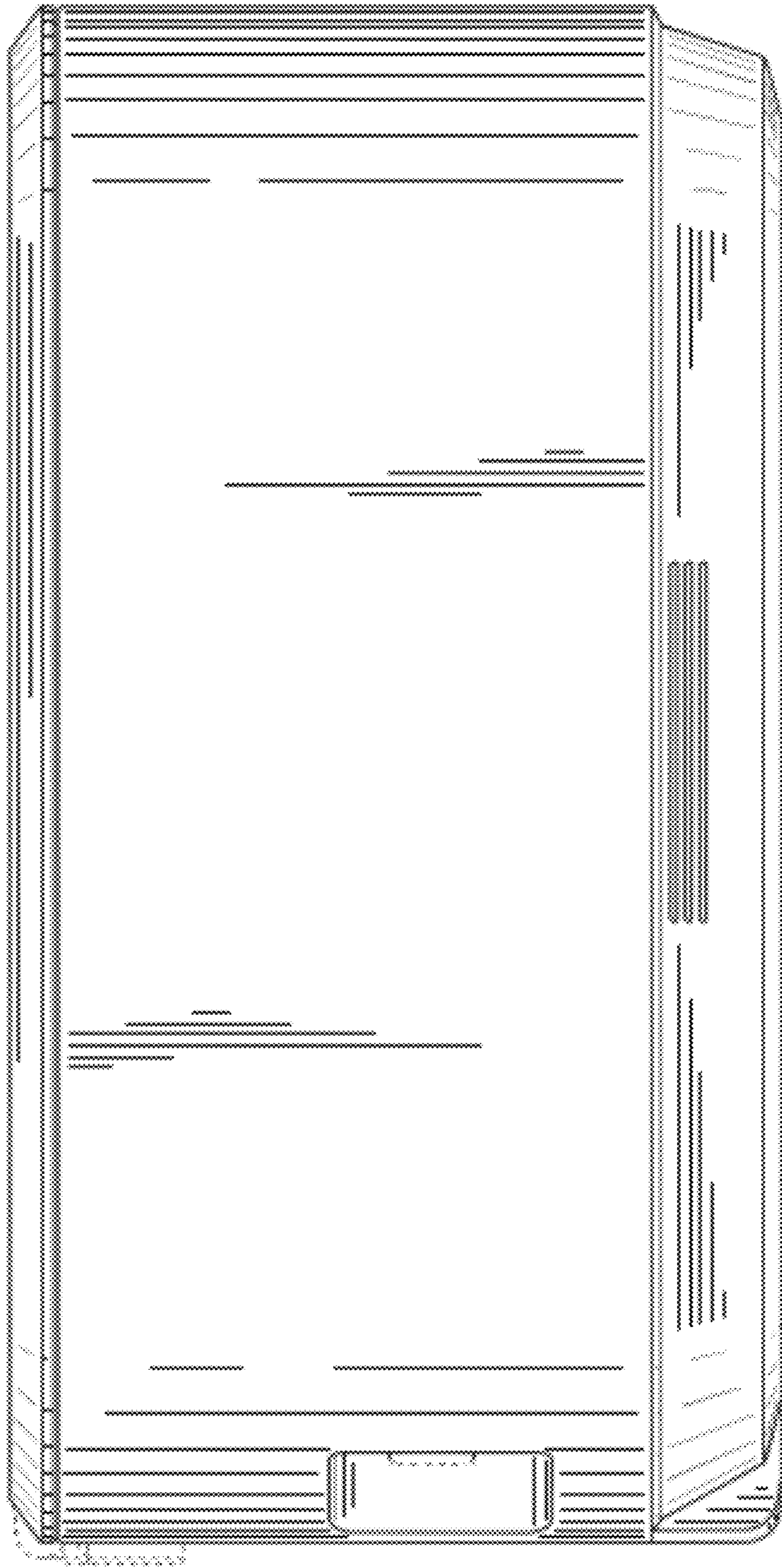

FIG. 5

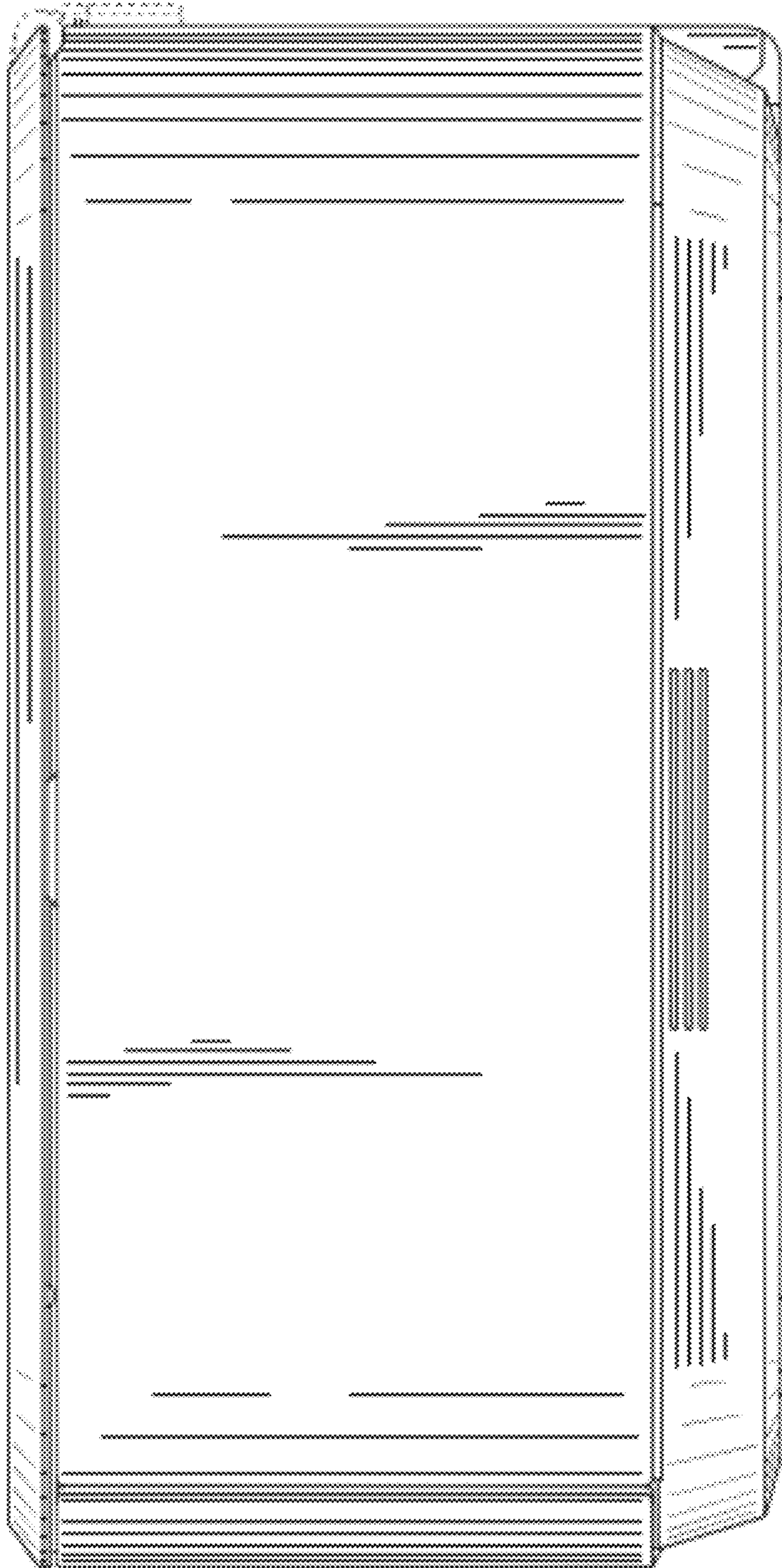

FIG. 6

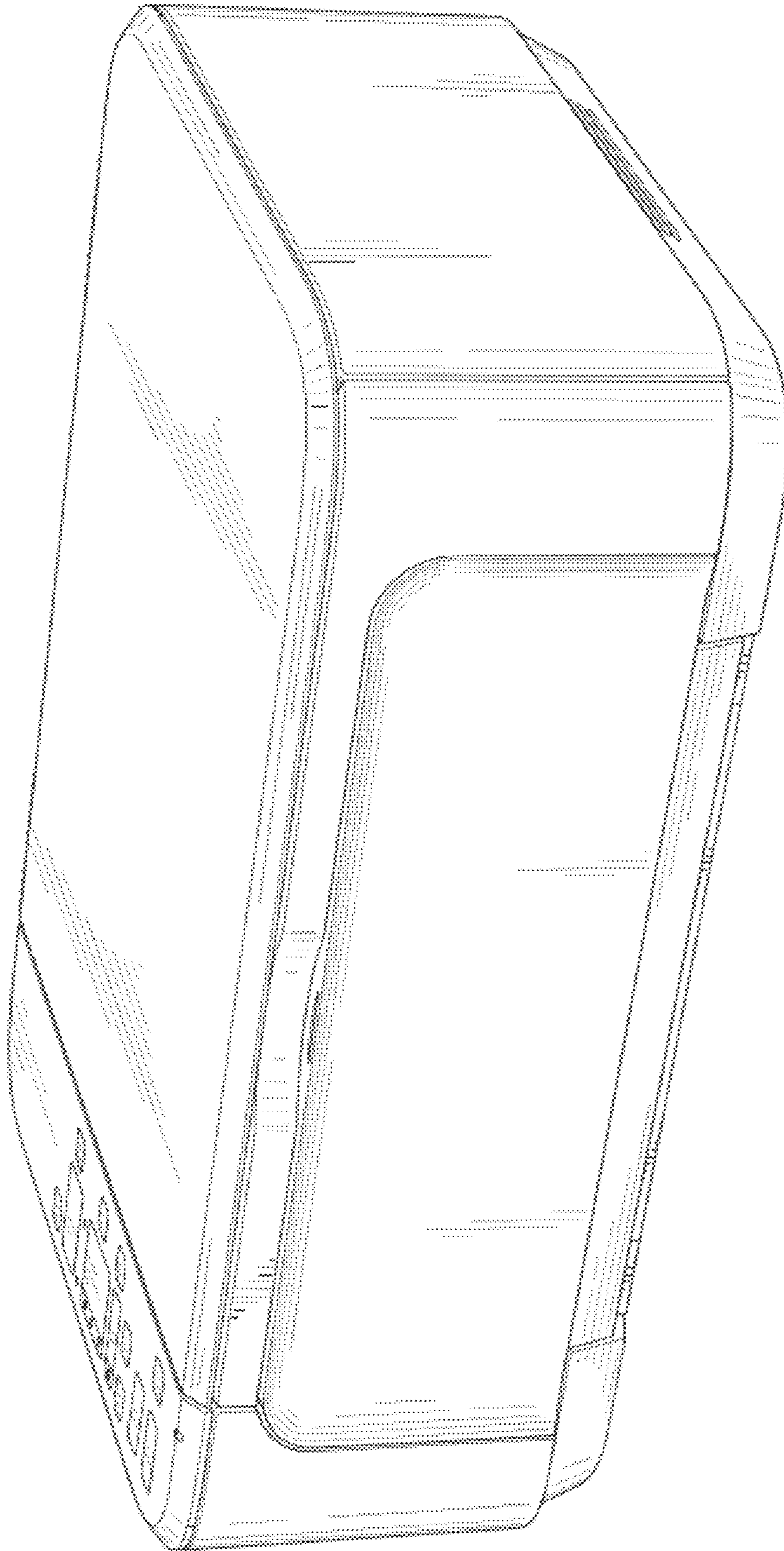

FIG. 7