



US00D667011S

(12) **United States Design Patent**
Wu et al.

(10) **Patent No.:** **US D667,011 S**
(45) **Date of Patent:** **** Sep. 11, 2012**

(54) **ADAPTOR FOR TABLET PERSONAL COMPUTER**
(75) Inventors: **Chien-Ming Wu**, Taipei (TW);
Jung-Wen Chang, Taoyuan County (TW); **Shih-Yun Lee**, New Taipei (TW)
(73) Assignee: **Quanta Computer Inc.**, Taoyuan Shien (TW)
(**) Term: **14 Years**

(21) Appl. No.: **29/407,053**
(22) Filed: **Nov. 22, 2011**

(30) **Foreign Application Priority Data**
Sep. 2, 2011 (TW) 100304572

(51) **LOC (9) Cl.** **08-07**

(52) **U.S. Cl.** **D14/447**

(58) **Field of Classification Search** D14/447,
D14/432, 433, 434, 439, 448, 451, 452, 217,
D14/239, 250, 251, 253, 238.1; D13/107,
D13/108; D21/333; D6/300, 310, 311, 312,
D6/406.1, 406.2, 406.3, 406.4, 406.5, 406.6,
D6/419; D8/363, 373, 380

See application file for complete search history.

(56) **References Cited**

U.S. PATENT DOCUMENTS

D457,162 S * 5/2002 Hawkins et al. D14/434

D494,182 S * 8/2004 Singer et al. D14/451
D520,013 S * 5/2006 Yang D14/434
D557,693 S * 12/2007 Kim et al. D14/251
D584,731 S * 1/2009 Montgomery et al. D14/434
D599,801 S * 9/2009 Skaf et al. D14/434
D603,840 S * 11/2009 Lee et al. D14/217
D635,918 S * 4/2011 Le et al. D13/108
D642,519 S * 8/2011 Woo et al. D13/108
D648,325 S * 11/2011 Akana et al. D14/217
D652,834 S * 1/2012 Jones et al. D14/434
8,162,283 B1 * 4/2012 Royz et al. 248/455
2012/0074286 A1 * 3/2012 Chou 248/346.03

* cited by examiner

Primary Examiner — Angela J Lee

(74) *Attorney, Agent, or Firm* — Rabin & Berdo, P.C.

(57) **CLAIM**

The ornamental design for an adaptor for tablet personal computer, as shown.

DESCRIPTION

FIG. 1 is a perspective view of an adaptor for tablet personal computer showing our new design;
FIG. 2 is a front view thereof;
FIG. 3 is a rear view thereof;
FIG. 4 is a left side view thereof;
FIG. 5 is a right side view thereof;
FIG. 6 is a top view thereof; and,
FIG. 7 is a bottom view thereof.

1 Claim, 4 Drawing Sheets

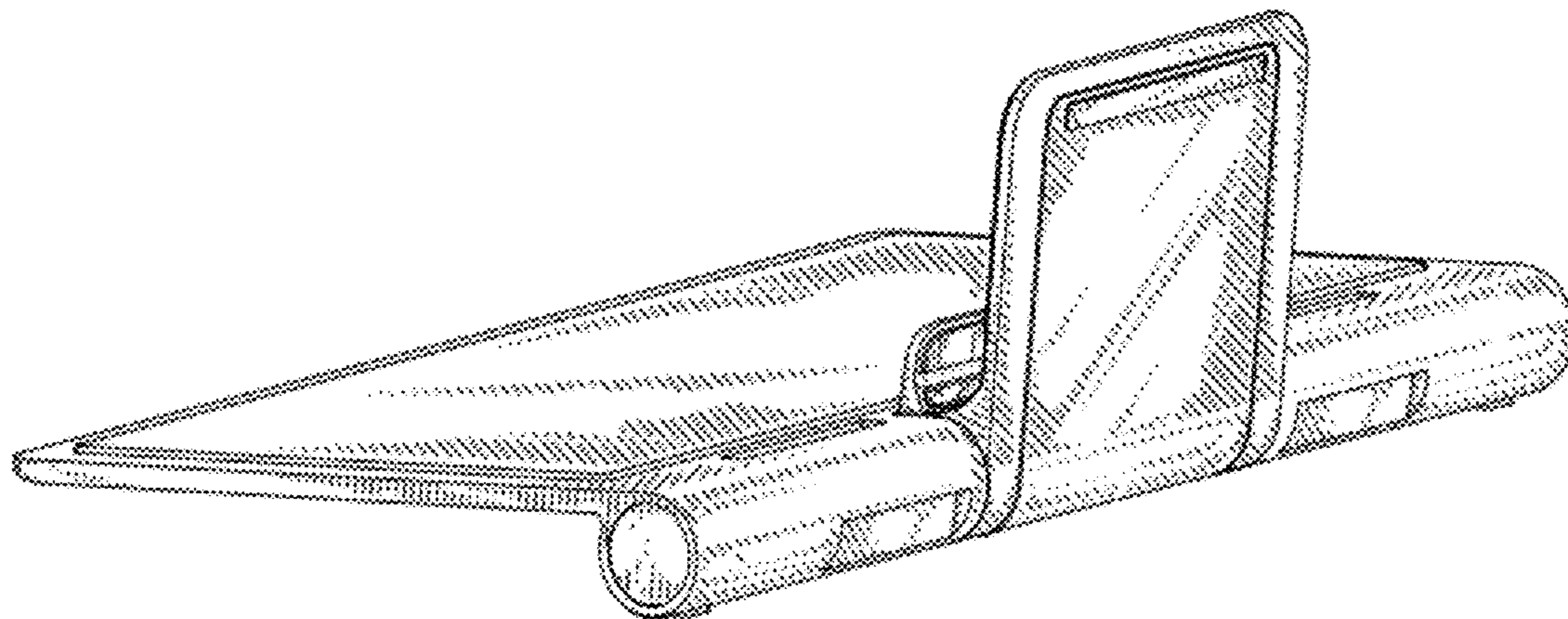

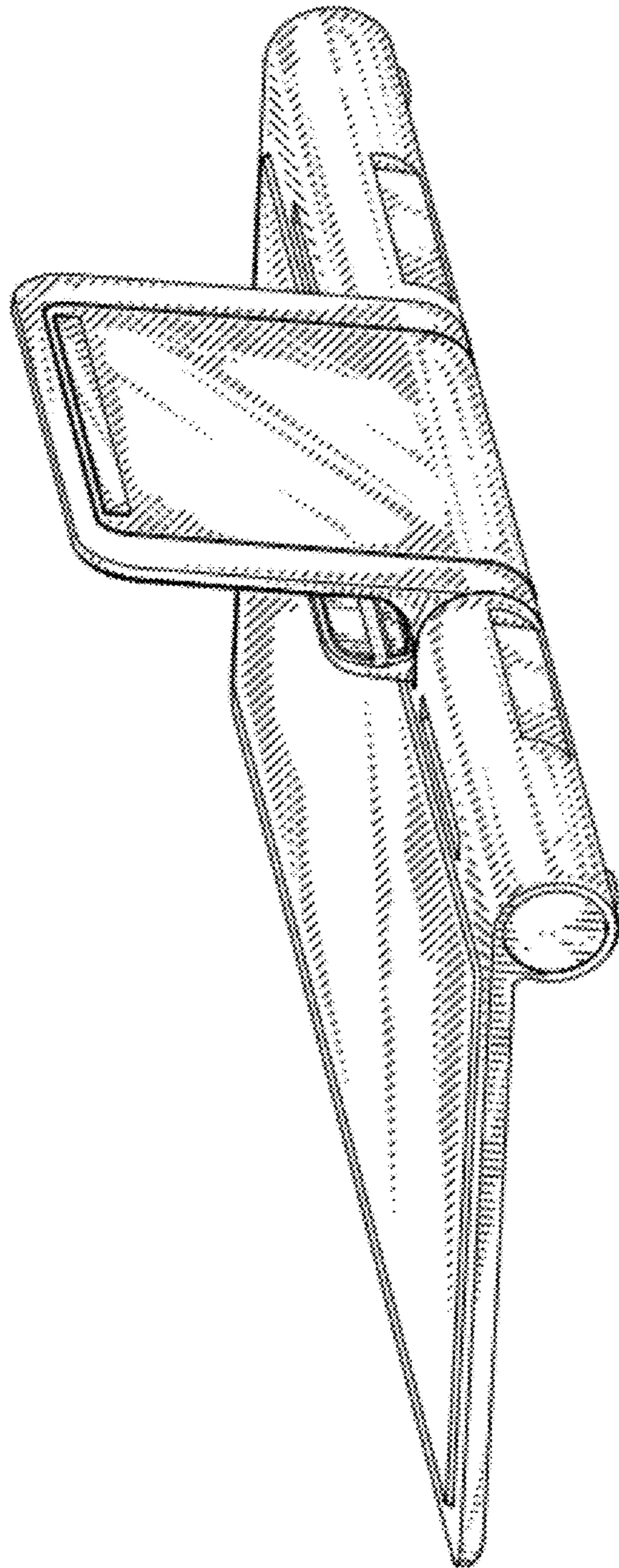

FIG. 1

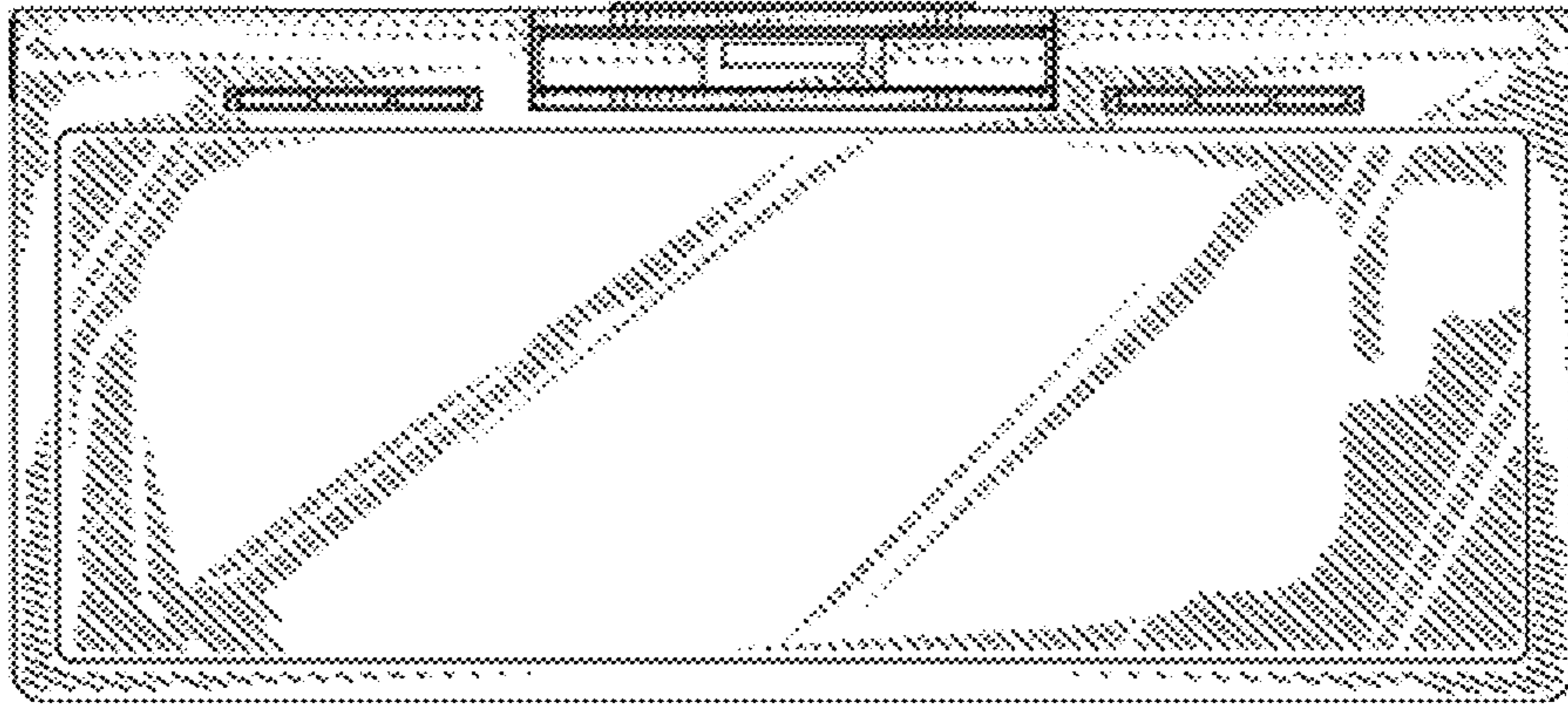

FIG. 2

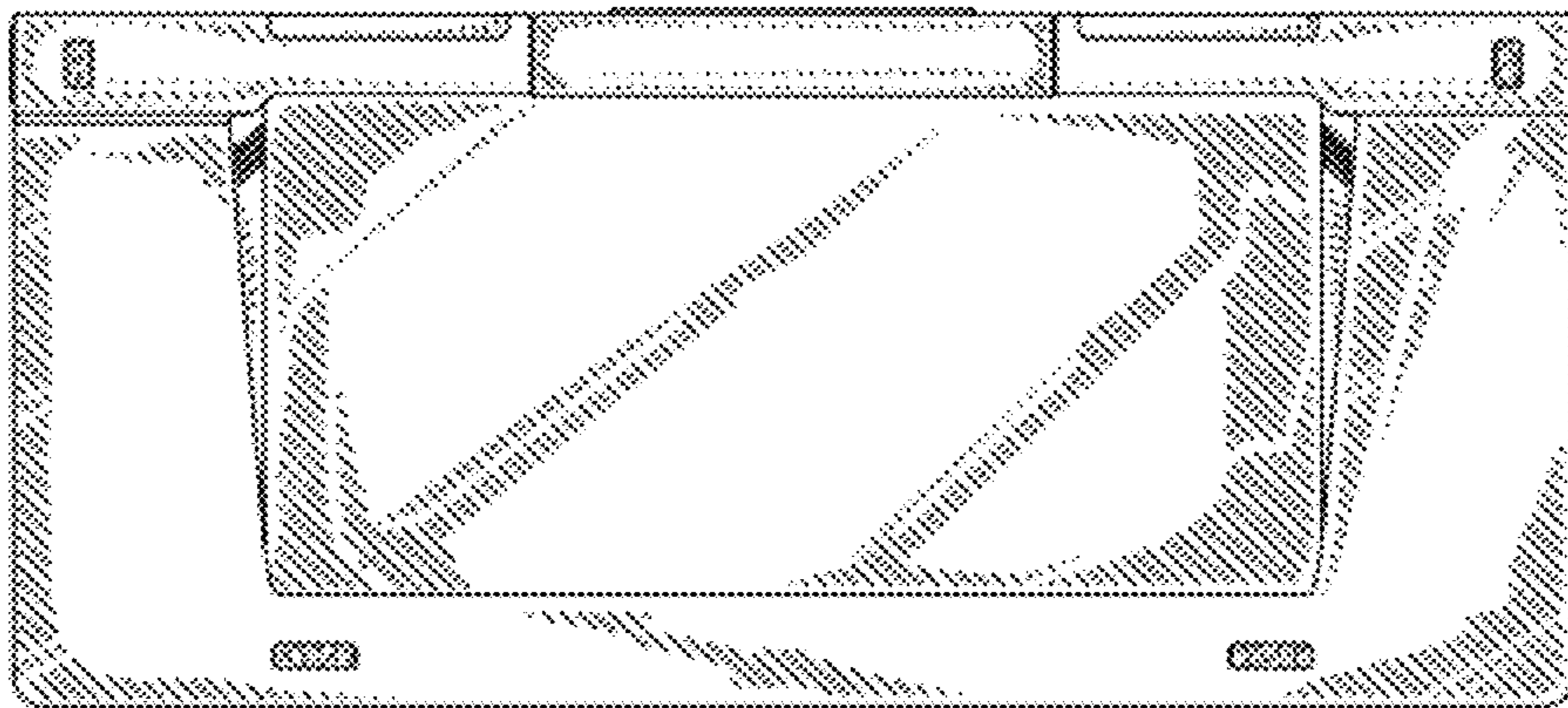

FIG. 3

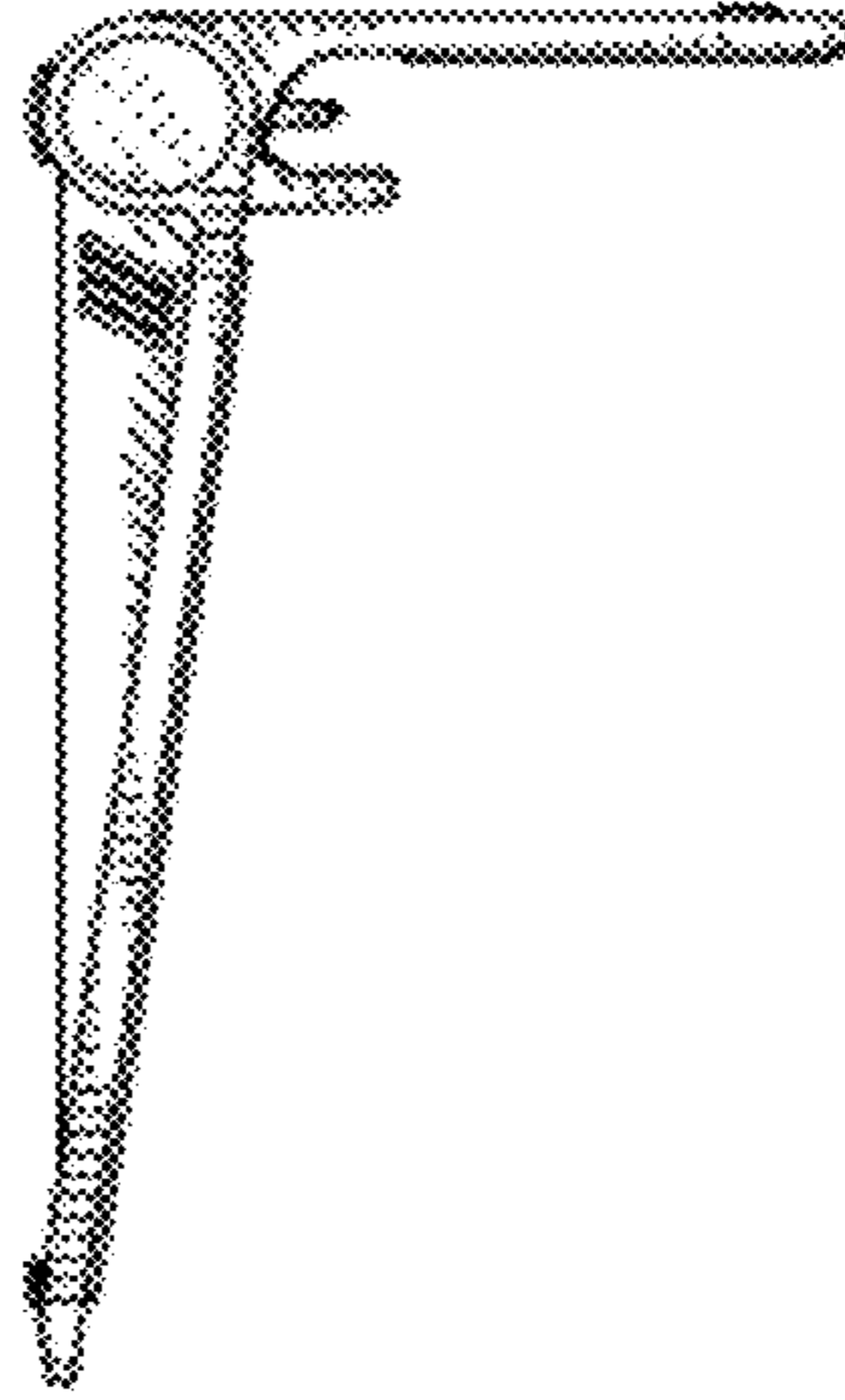

FIG. 4

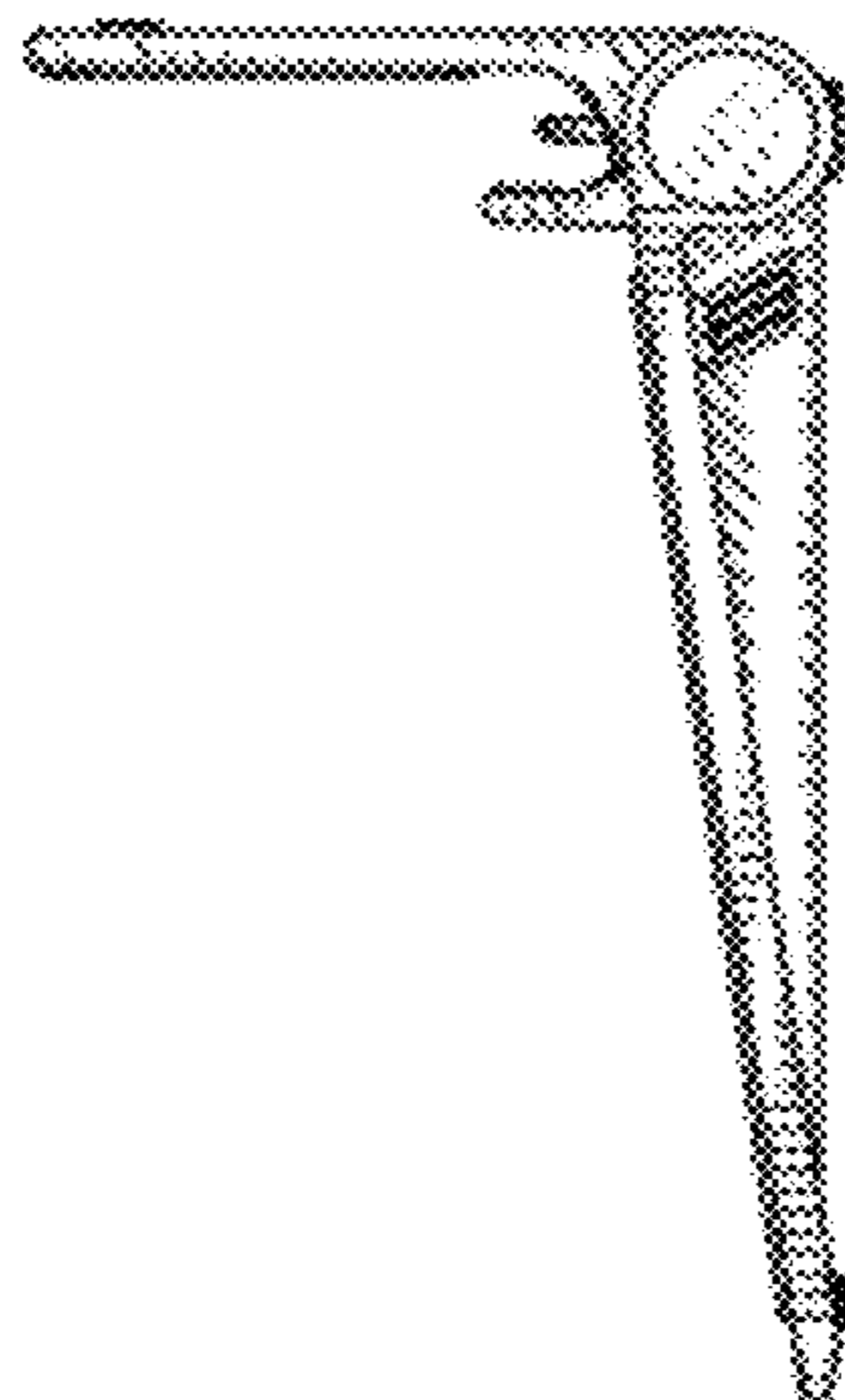

FIG. 5

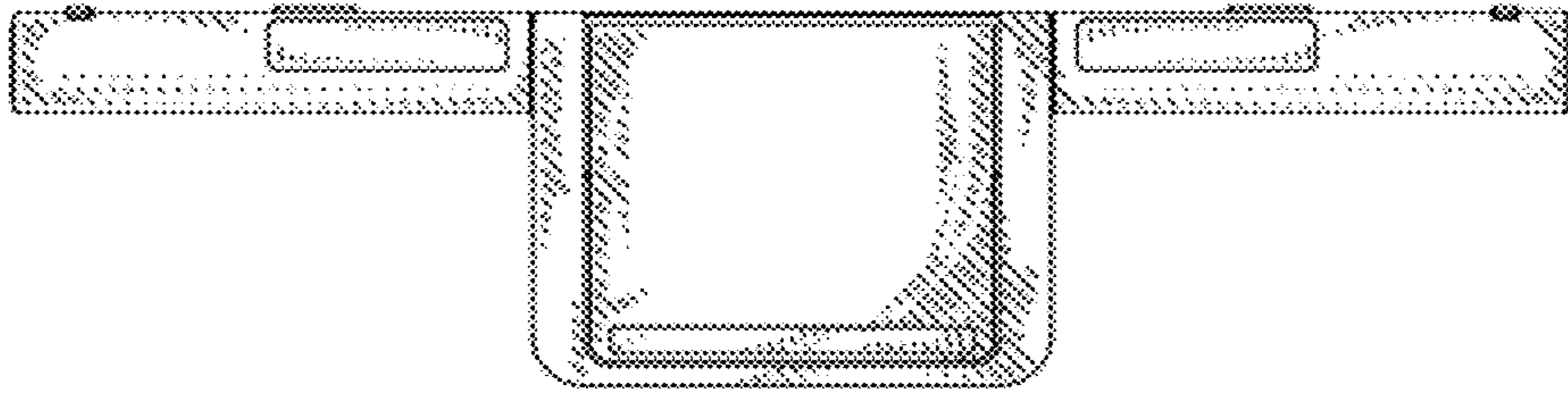

FIG. 6

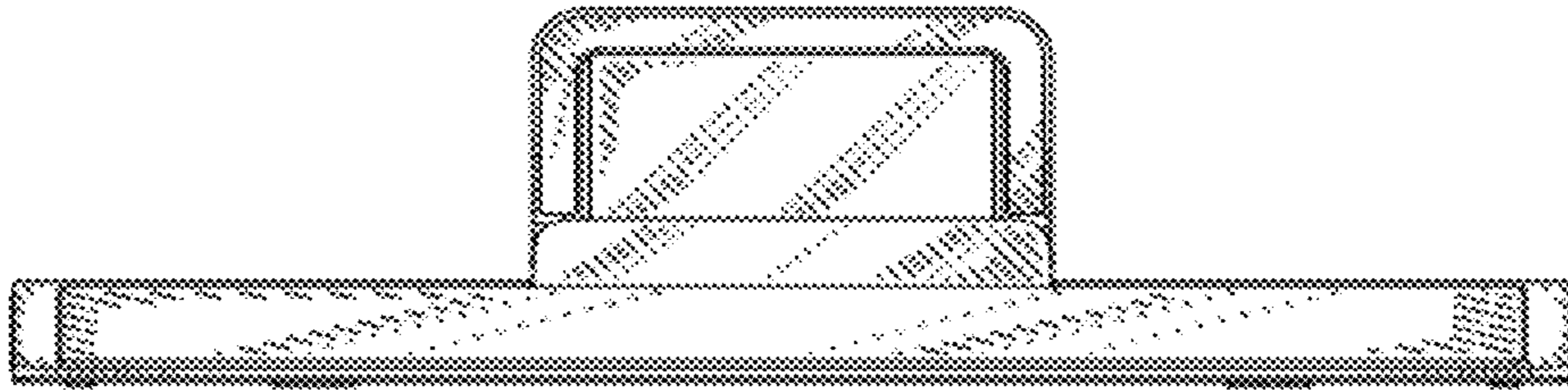

FIG. 7