



US00D666961S

(12) **United States Design Patent**
Chung

(10) **Patent No.:** **US D666,961 S**

(45) **Date of Patent:** **** Sep. 11, 2012**

(54) **WHEEL**

(75) Inventor: **Suny Chung**, Yorba Linda, CA (US)

(73) Assignee: **Wheel Pros, LLC**, Lakewood, CO (US)

(**) Term: **14 Years**

(21) Appl. No.: **29/423,420**

(22) Filed: **May 31, 2012**

(51) **LOC (9) Cl.** **12-16**

(52) **U.S. Cl.** **D12/211**

(58) **Field of Classification Search** D12/204-213;
301/37.101, 64.101, 65, 64.201

See application file for complete search history.

(56) **References Cited**

U.S. PATENT DOCUMENTS

D415,094 S *	10/1999	Neeper	D12/211
D500,005 S *	12/2004	van Hooydonk	D12/211
D569,777 S *	5/2008	Chung	D12/211
D617,250 S *	6/2010	Zhao	D12/211
D617,718 S *	6/2010	Zhao	D12/211
D618,156 S *	6/2010	Zhao	D12/211
D619,952 S *	7/2010	Juergens et al.	D12/211
D626,489 S *	11/2010	Laengerer	D12/211
D632,240 S *	2/2011	Szews	D12/211
D655,234 S *	3/2012	Zhao	D12/211
D657,299 S *	4/2012	Lee	D12/211

* cited by examiner

Primary Examiner — Stacia Cadmus

(74) *Attorney, Agent, or Firm* — Garcia-Zamor IP Law; Ruy M. Garcia-Zamor

(57) **CLAIM**

The ornamental design for a wheel, as shown and described.

DESCRIPTION

FIG. 1 is a perspective view of a wheel showing my new design;

FIG. 2 is a front elevational view of the wheel of FIG. 1;

FIG. 3 is a left side elevational view of the wheel of FIG. 1, the right side elevational view of the wheel of FIG. 1 is a mirror image of FIG. 3;

FIG. 4 is a top plan view of the wheel of FIG. 1;

FIG. 5 is a bottom plan view of the wheel of FIG. 1;

FIG. 6 is a rear elevational view of the wheel of FIG. 1;

FIG. 7 is a perspective view of a wheel according to a second preferred embodiment of my new design;

FIG. 8 is a front elevational view of the wheel of FIG. 7;

FIG. 9 is a left side elevational view of the wheel of FIG. 7, the right side elevational view of the wheel of FIG. 7 is a mirror image of FIG. 9;

FIG. 10 is a top plan view of the wheel of FIG. 7;

FIG. 11 is a bottom plan view of the wheel of FIG. 7; and,

FIG. 12 is a rear elevational view of the wheel of FIG. 7.

The broken lines in FIGS. 1-12 represent environment and are for illustrative purposes only and do not constitute part of the claimed design.

1 Claim, 10 Drawing Sheets

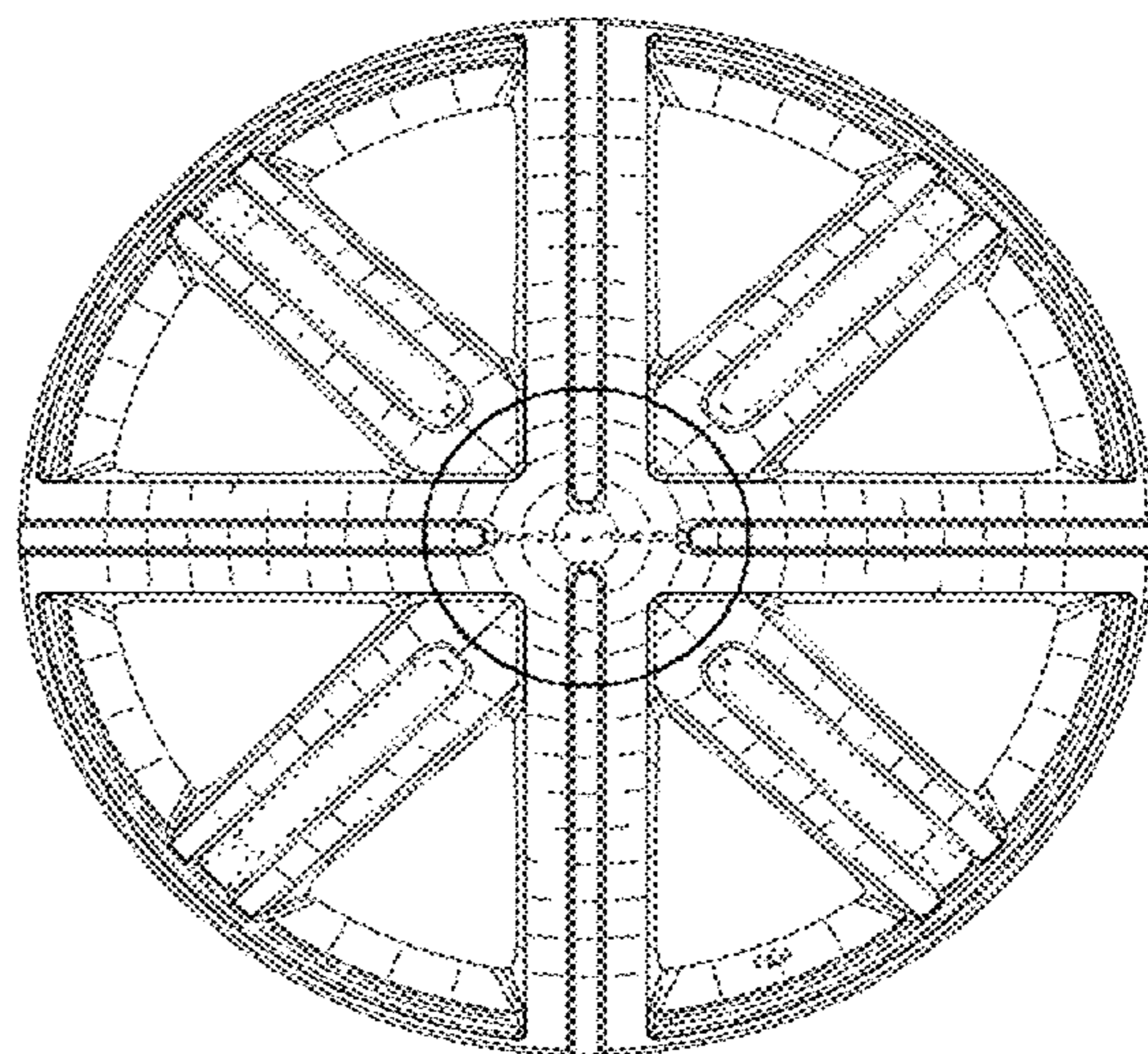
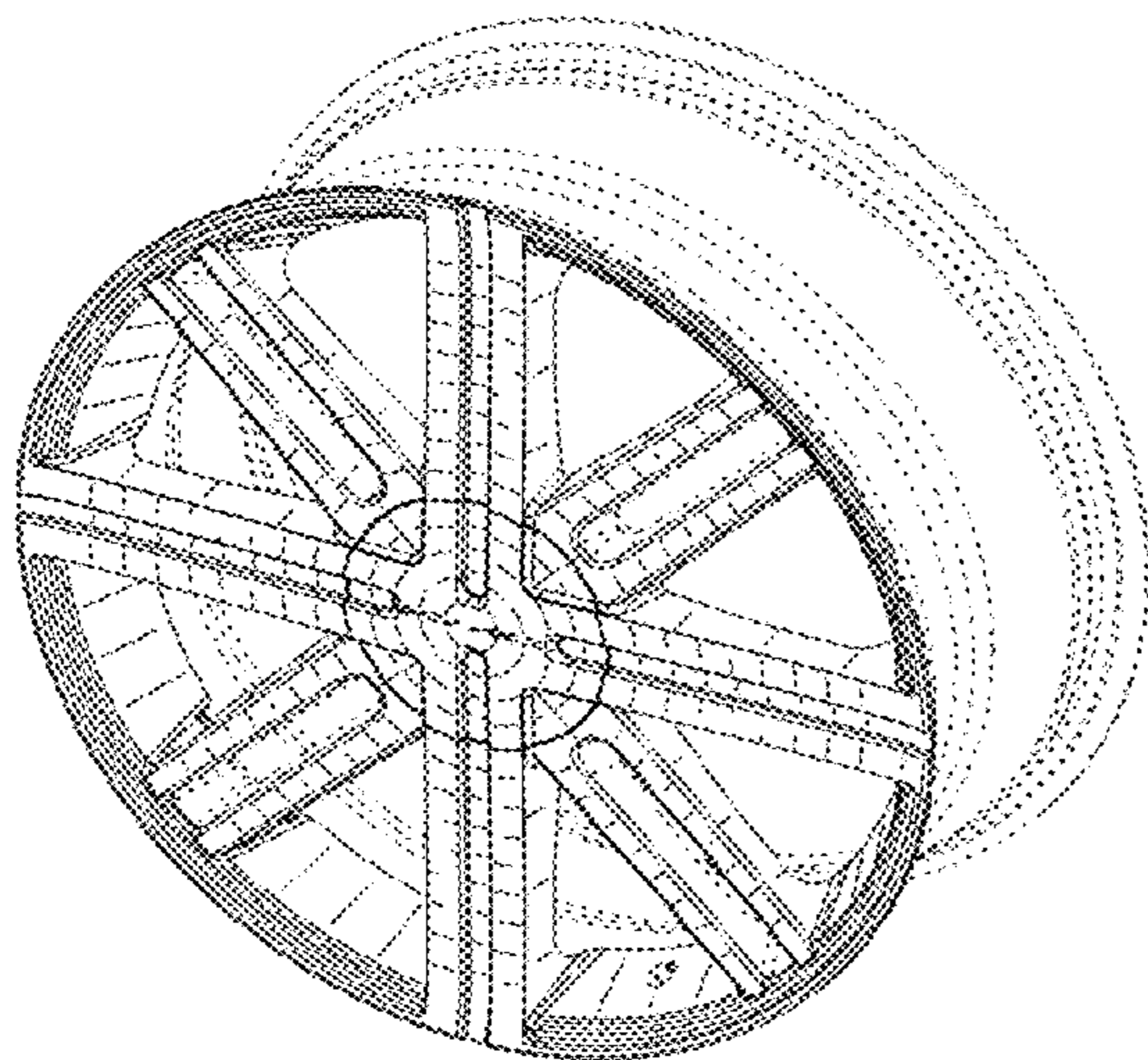

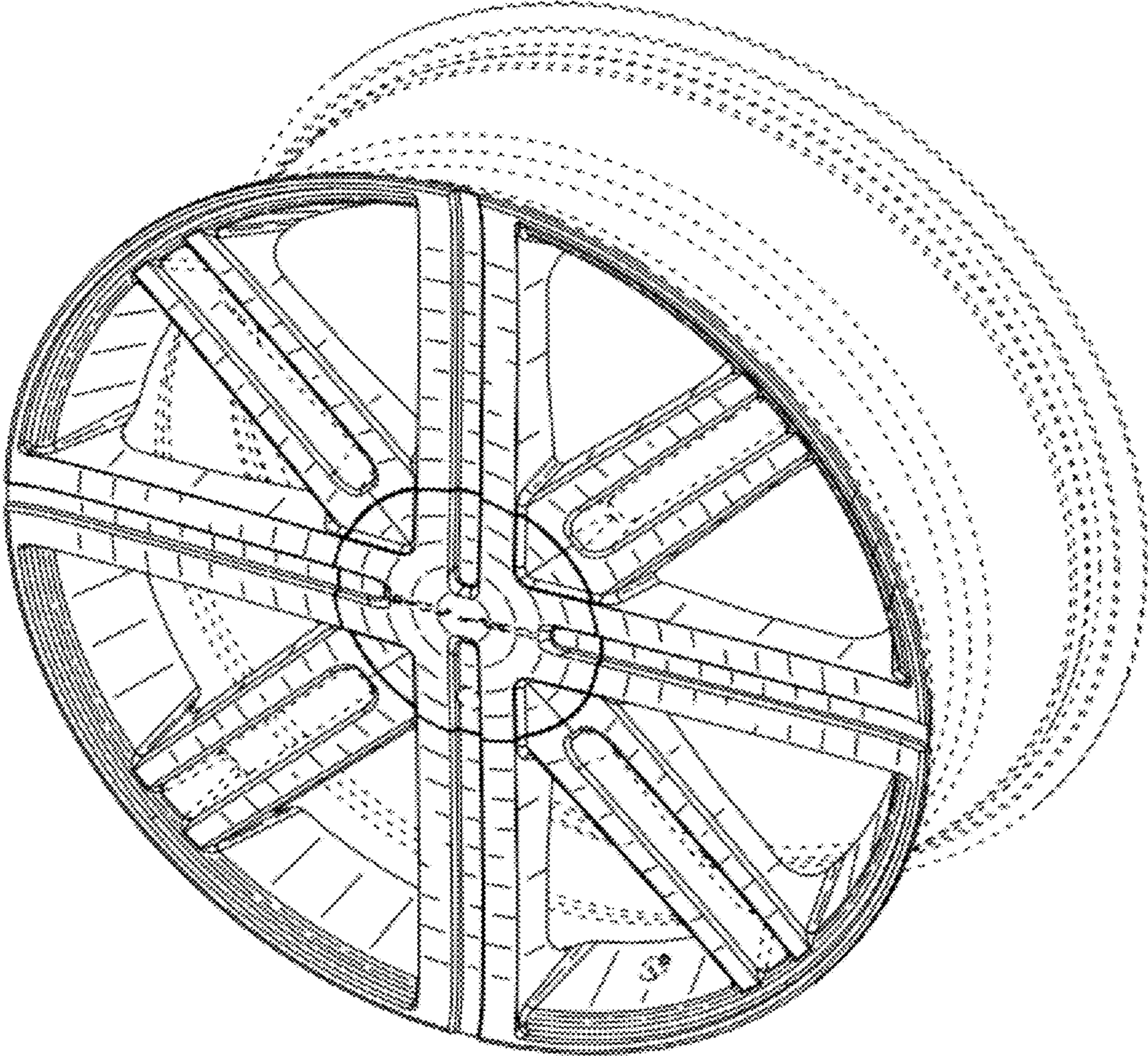

FIG. 1

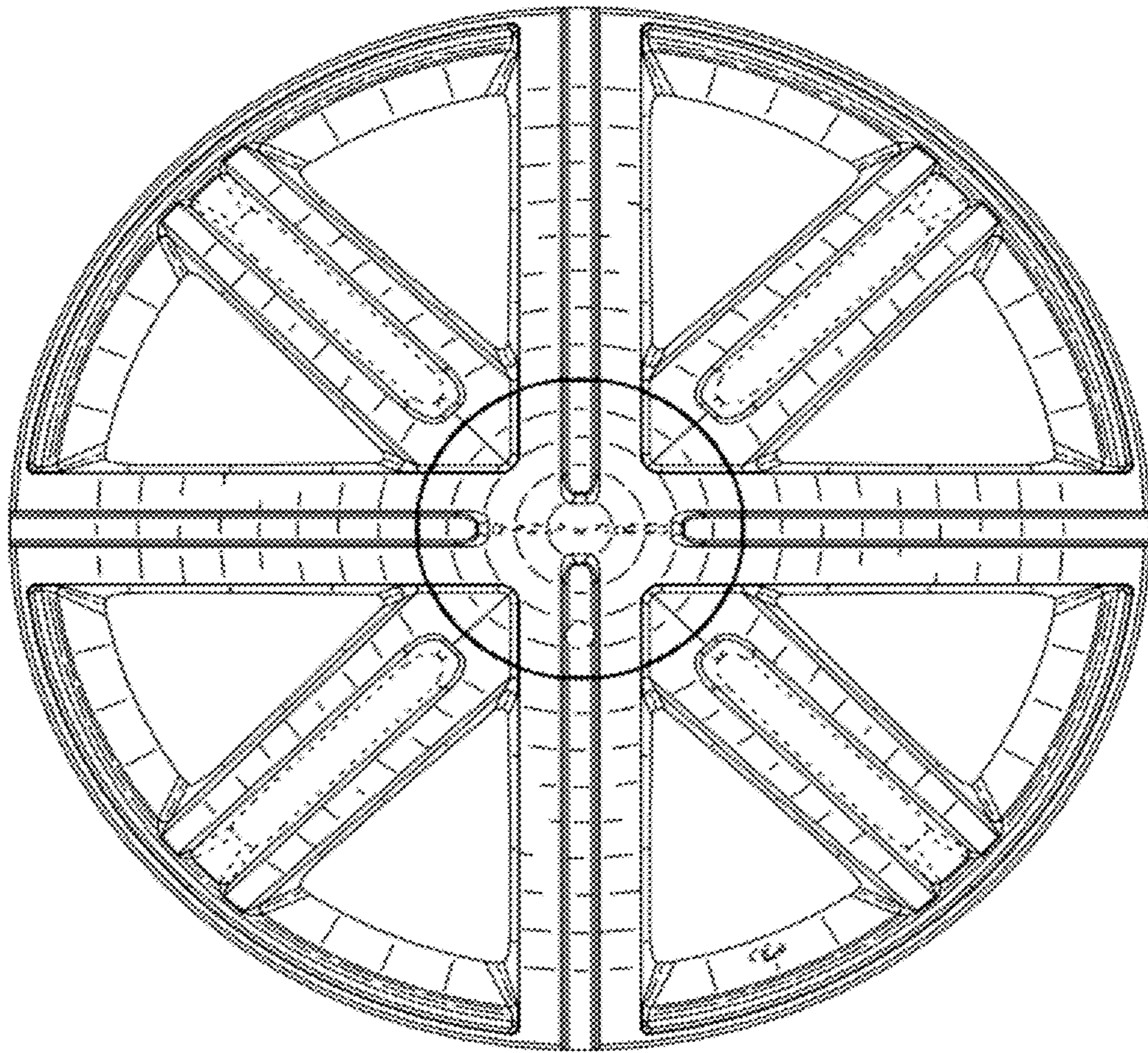

FIG. 2

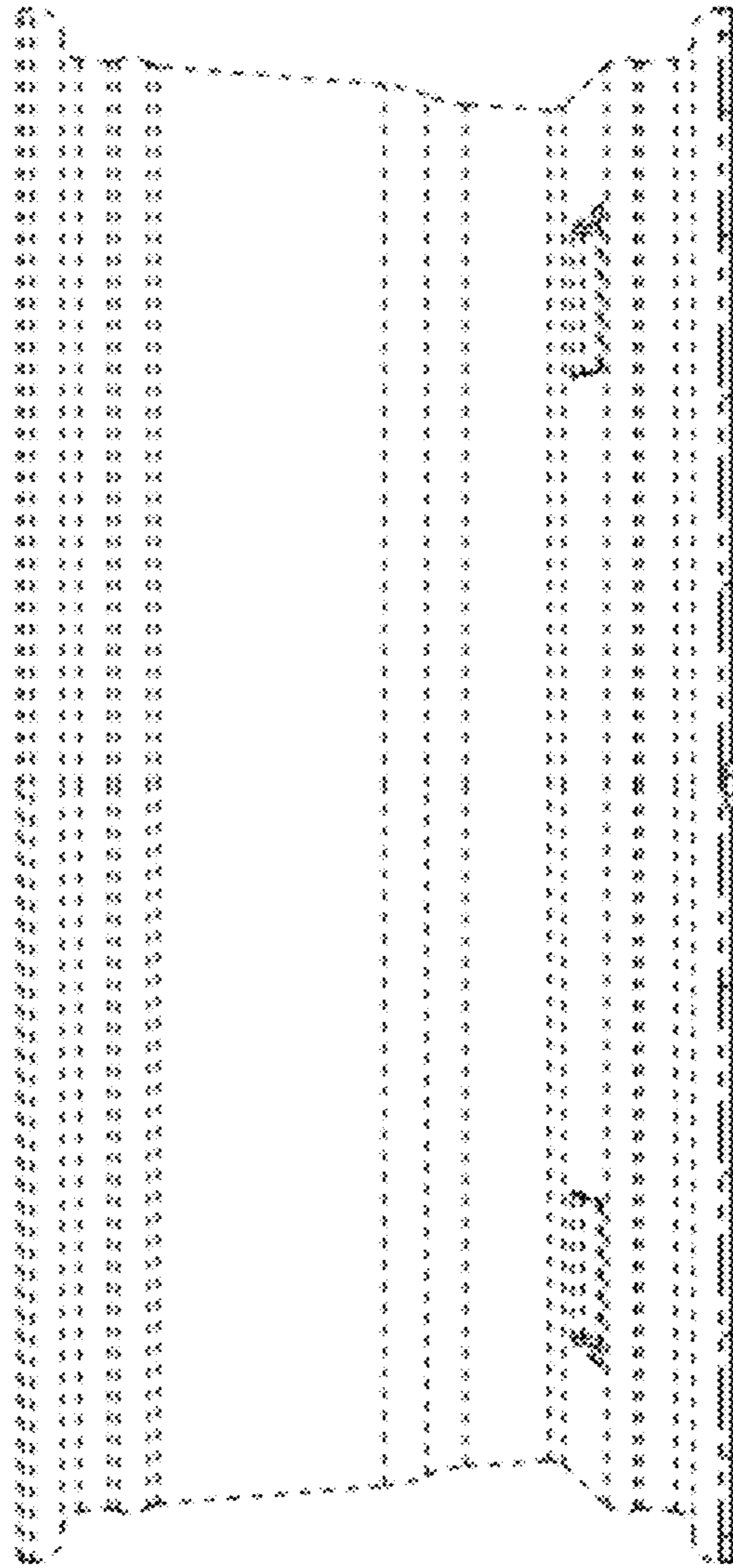

FIG. 3

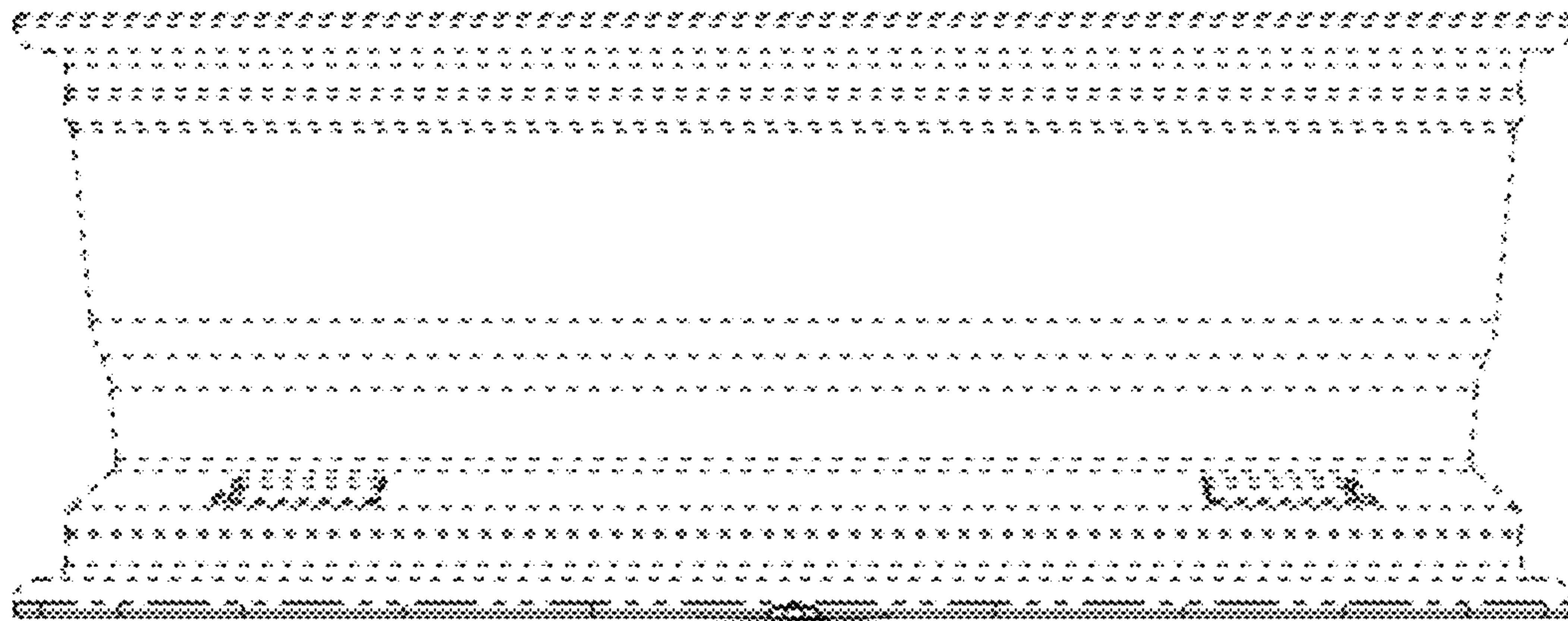

FIG. 4

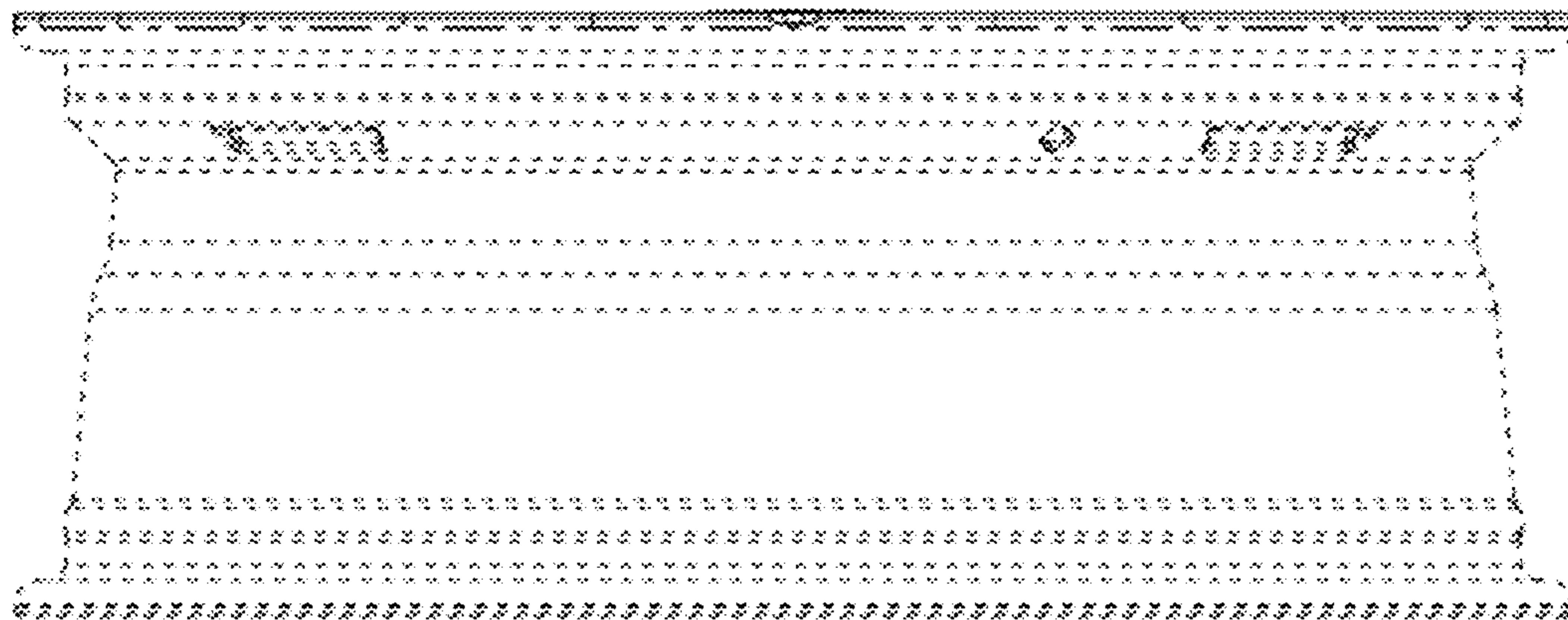

FIG. 5

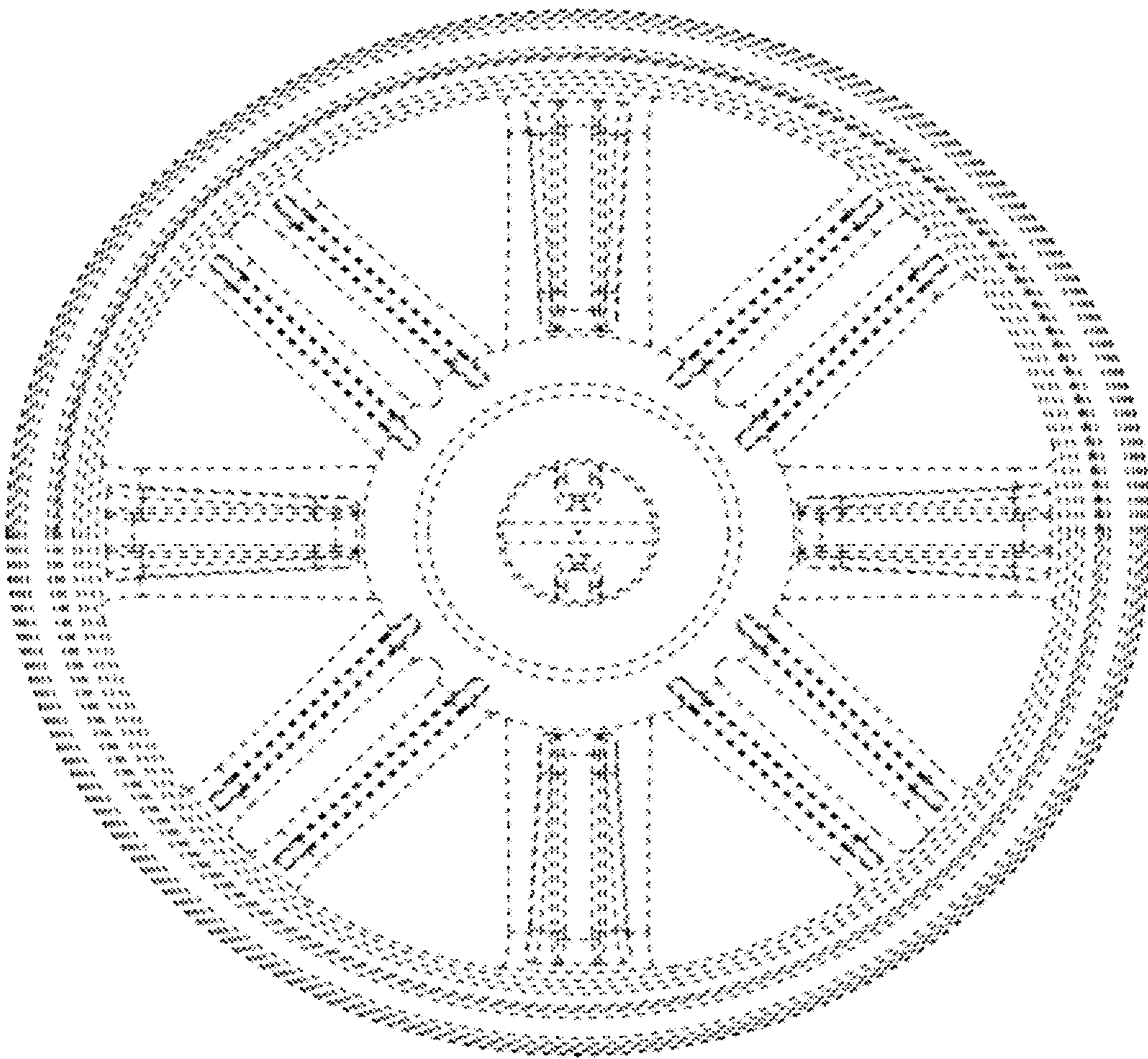

FIG. 6

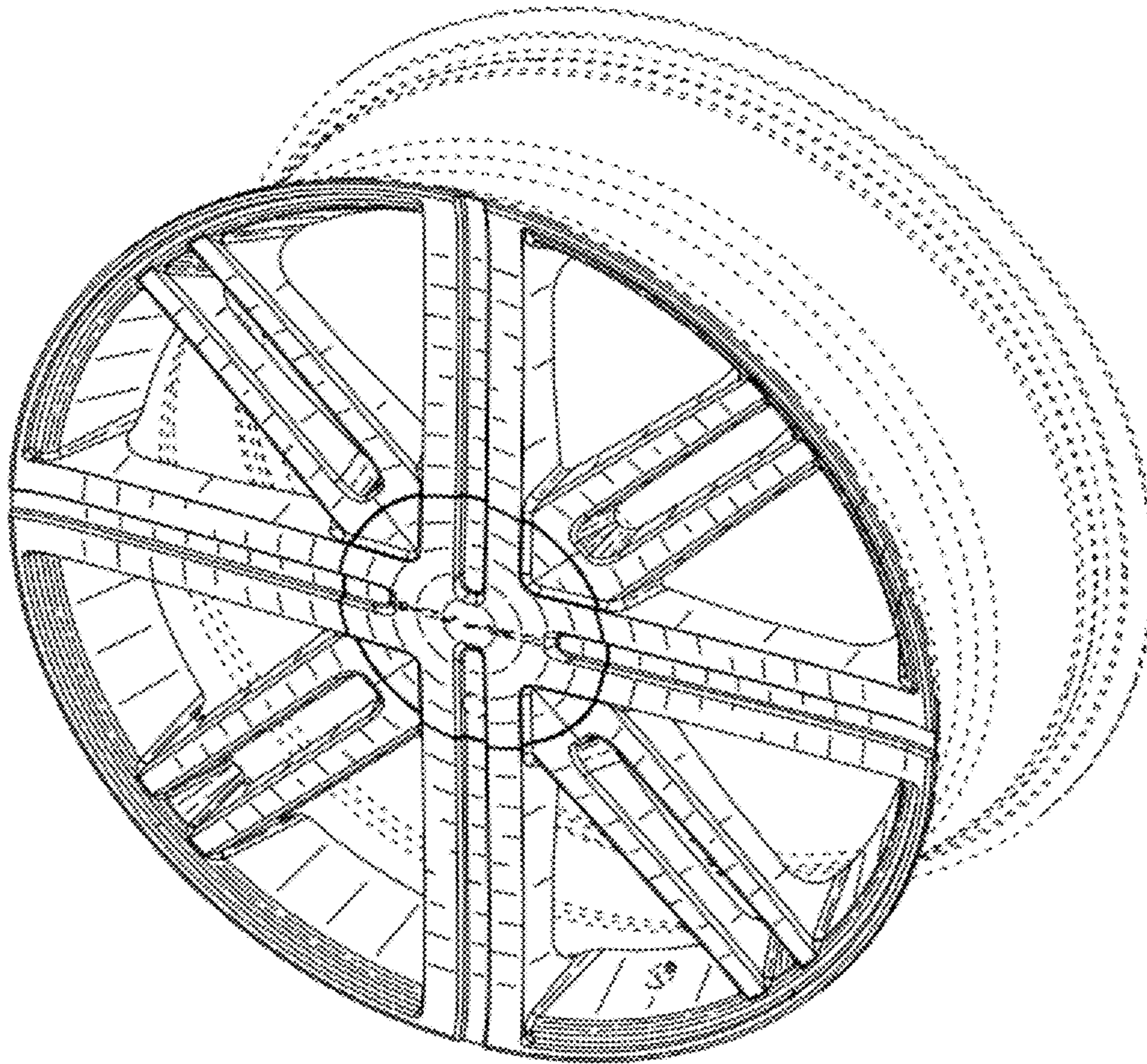

FIG. 7

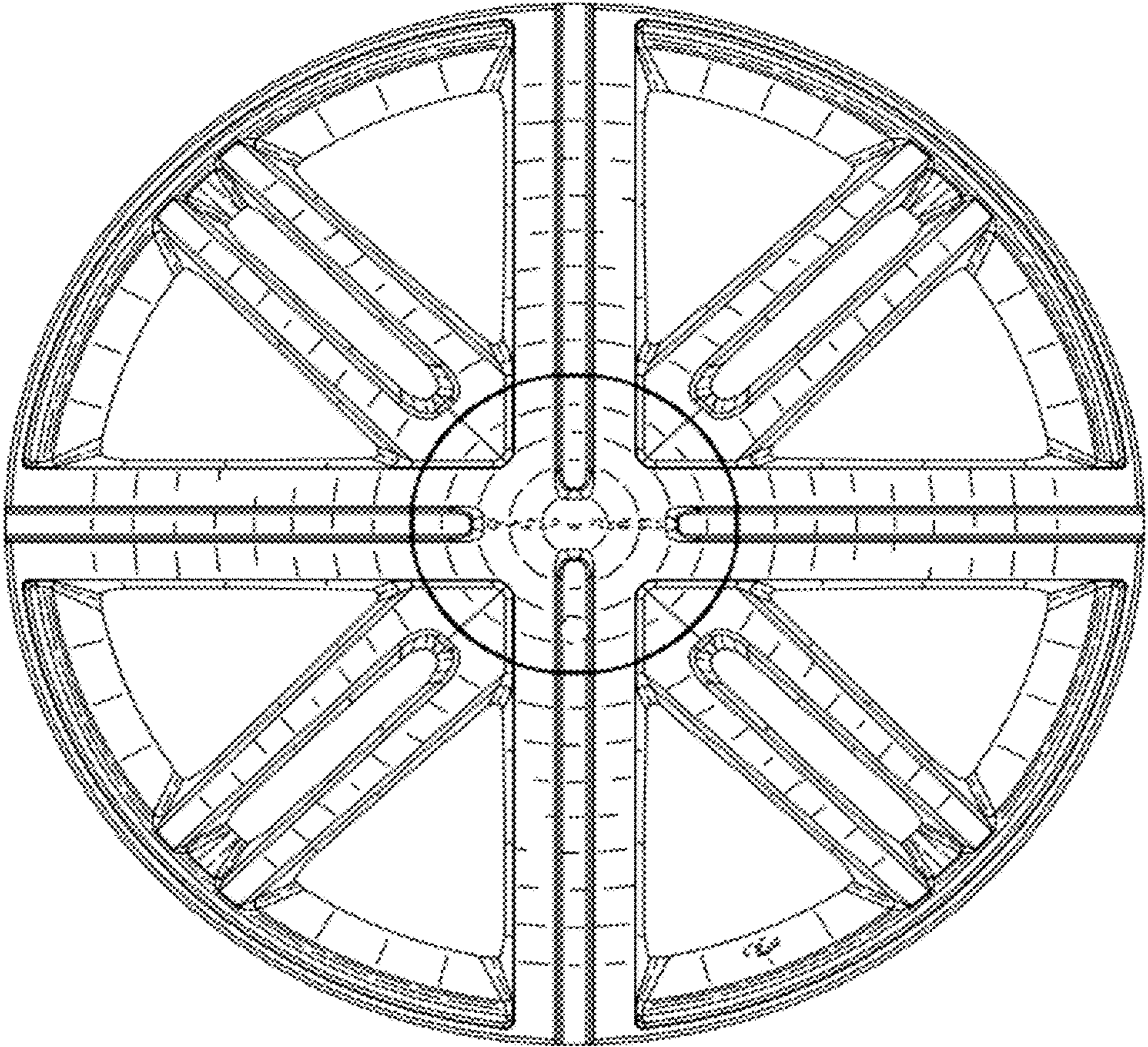

FIG. 8

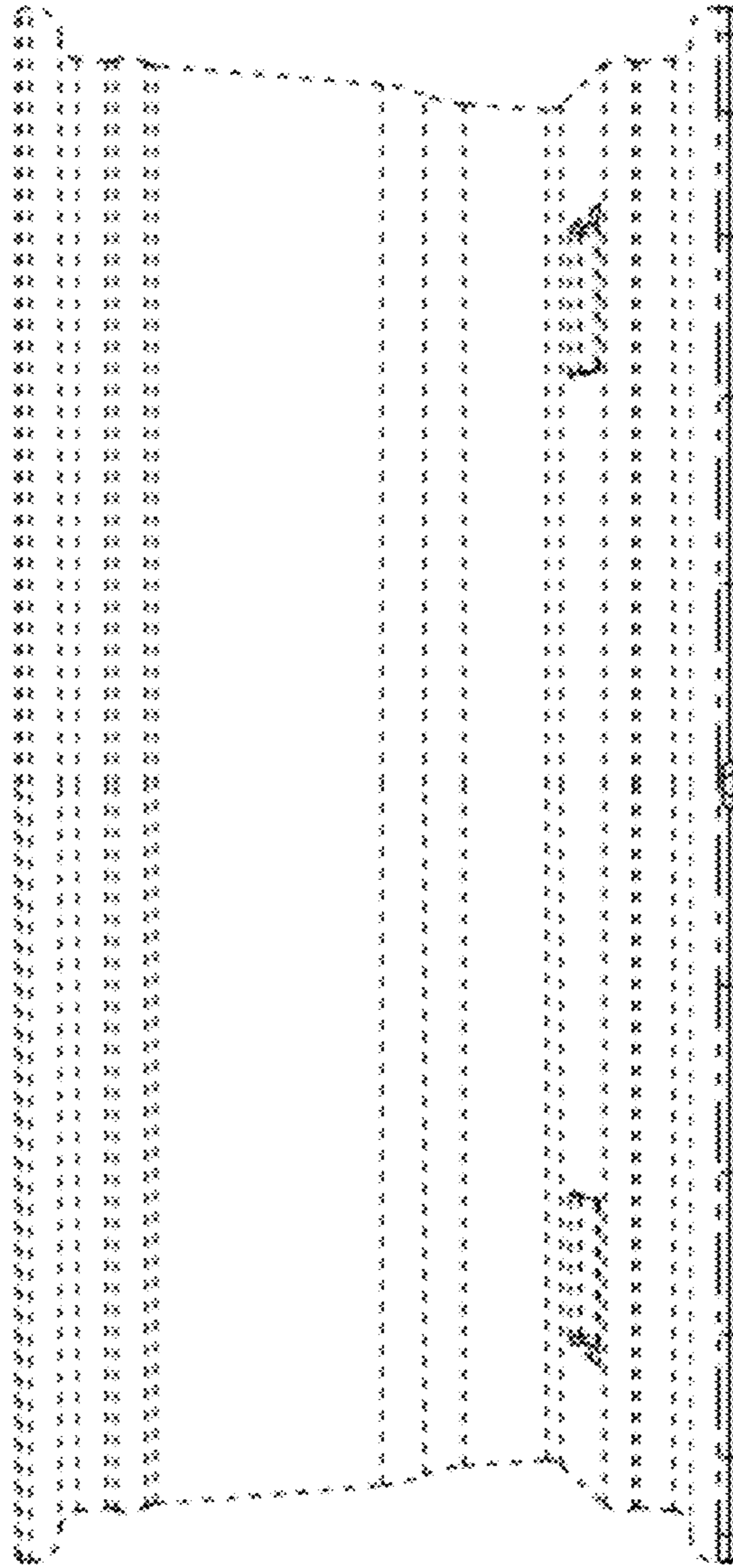

FIG. 9

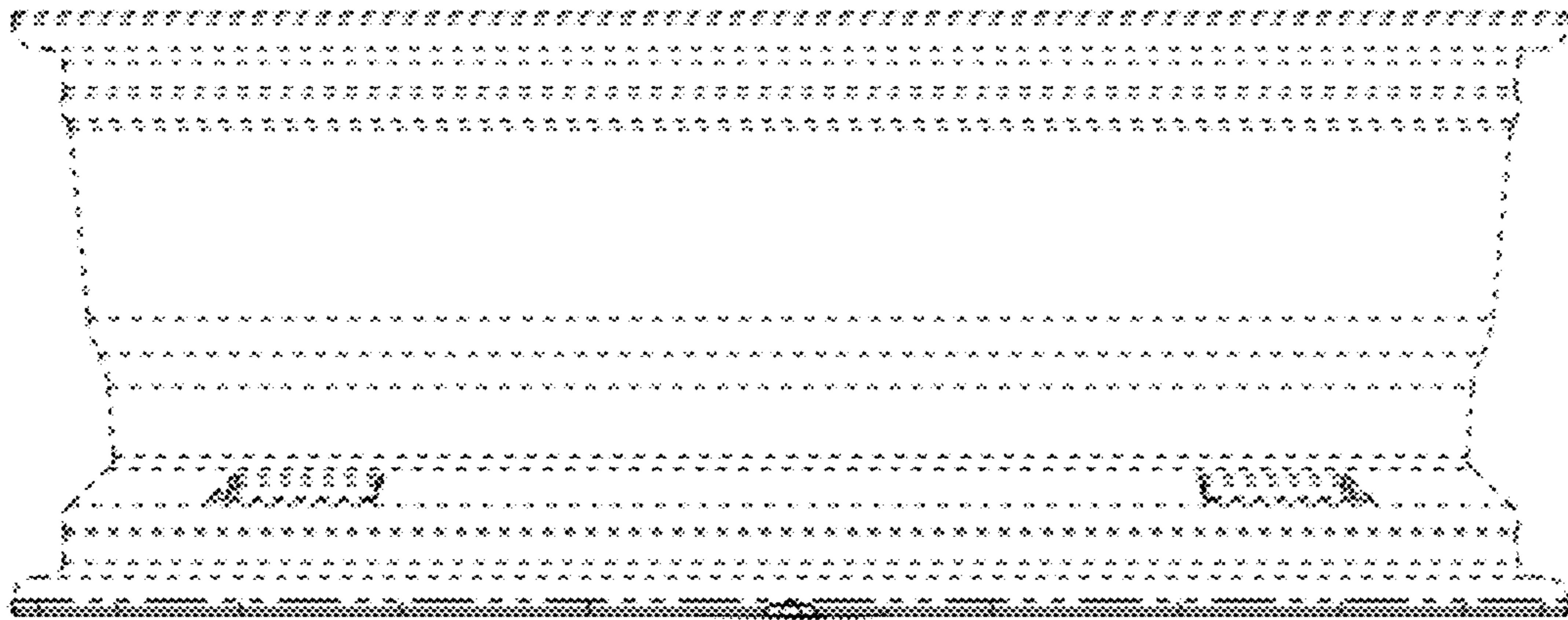

FIG. 10

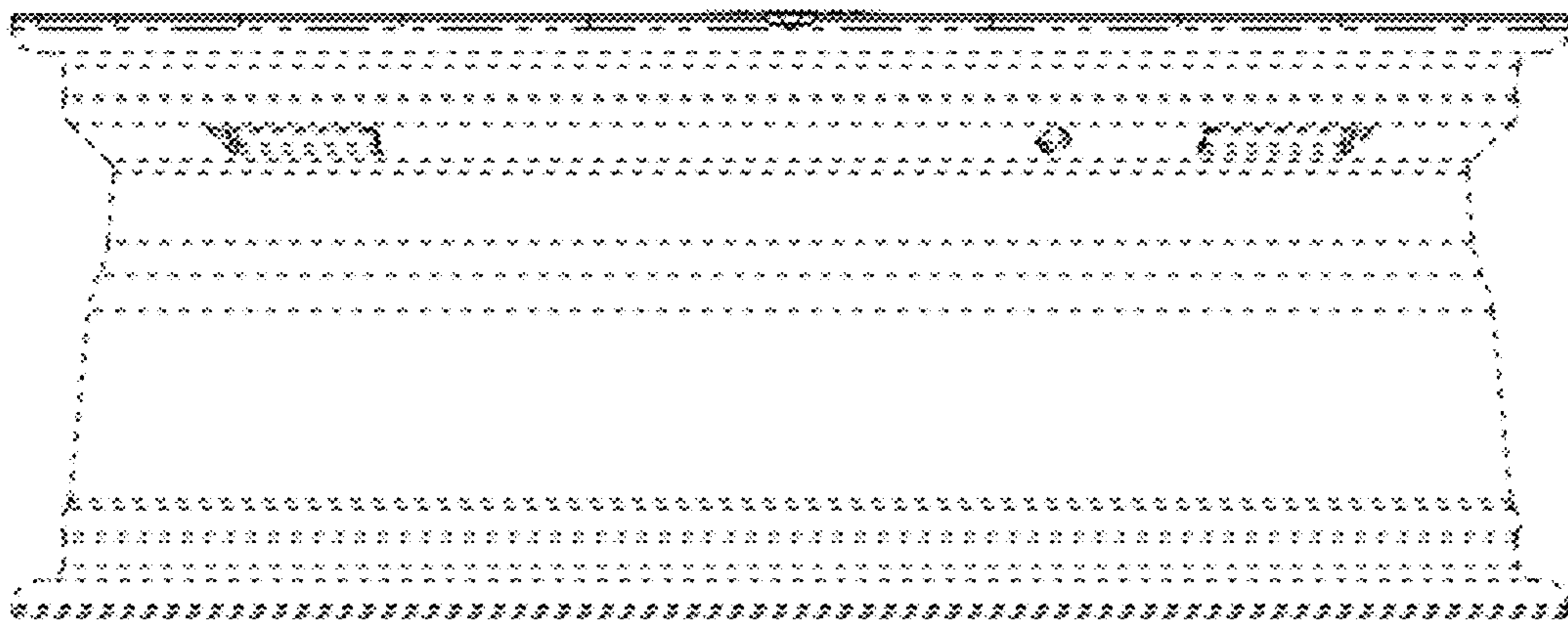

FIG. 11

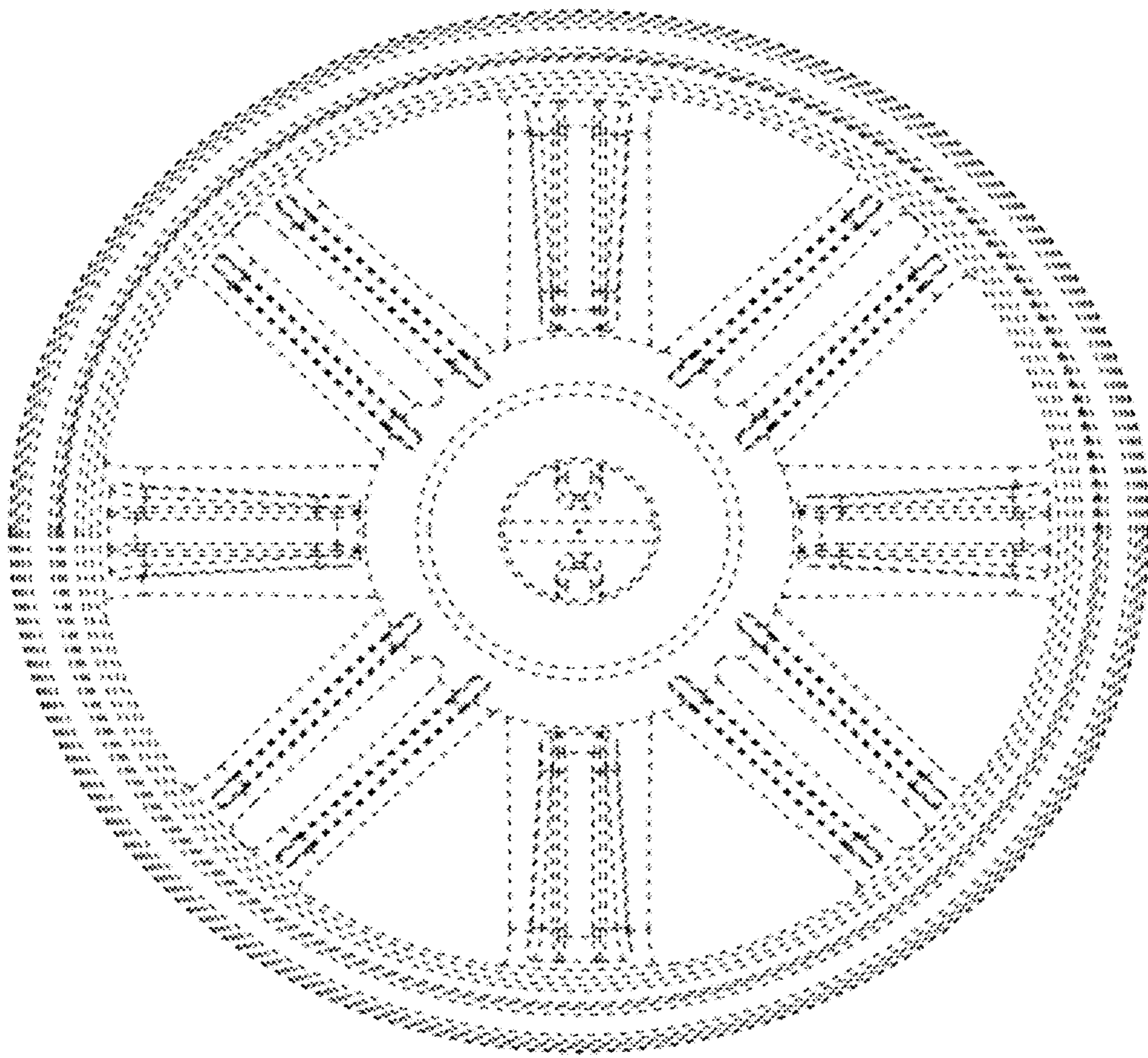

FIG. 12