



US00D666909S

(12) **United States Design Patent**
Bloc

(10) **Patent No.:** **US D666,909 S**

(45) **Date of Patent:** **** Sep. 11, 2012**

(54) **PUSH BUTTON**

(75) **Inventor:** **Richard René Bloc,**
Derchigny-Graincourt (FR)

(73) **Assignee:** **Rexam Dispensing Systems S.A.S.** (FR)

(**) **Term:** **14 Years**

(21) **Appl. No.:** **29/400,803**

(22) **Filed:** **Sep. 1, 2011**

(30) **Foreign Application Priority Data**

Mar. 1, 2011 (EM) 001828807-0001

(51) **LOC (9) Cl.** **09-07**

(52) **U.S. Cl.** **D9/448**

(58) **Field of Classification Search** D9/688,
D9/686, 682, 454, 448, 445, 44; D6/544,
D6/542; D28/76; D23/255, 252, 238; 222/630,
222/631, 566, 402.22, 402.13, 402.1, 401,
222/330, 331, 252, 153.07, 135

See application file for complete search history.

(56) **References Cited**

U.S. PATENT DOCUMENTS

D339,527 S * 9/1993 Tobler D9/448
D414,697 S * 10/1999 Sayers D9/448

D419,877 S * 2/2000 Sayers D9/448
D523,748 S * 6/2006 Witkowski et al. D9/448
D539,143 S * 3/2007 Arminak D9/448
D541,654 S * 5/2007 Pietrowski et al. D9/448
D574,707 S * 8/2008 Pietrowski et al. D9/448
D588,005 S * 3/2009 Boes et al. D9/448

* cited by examiner

Primary Examiner — Susan Bennett Hattan

(74) *Attorney, Agent, or Firm* — St. Onge Steward Johnston
& Reens LLC

(57) **CLAIM**

The ornamental design for a push button, as shown and described.

DESCRIPTION

FIG. 1 is a front isometric view of a push button in accordance with the new design;

FIG. 2 is a front elevation view thereof;

FIG. 3 is a left side elevation view thereof, a right side elevation view being mirror image thereof;

FIG. 4 is a rear elevation view thereof;

FIG. 5 is a top plan view thereof; and,

FIG. 6 is a bottom plan view thereof.

The broken lines shown in FIGS. 1, 2 and 6 represent the bounds of the claimed design, with the lines themselves and the areas within them forming no part of the claimed design.

1 Claim, 2 Drawing Sheets

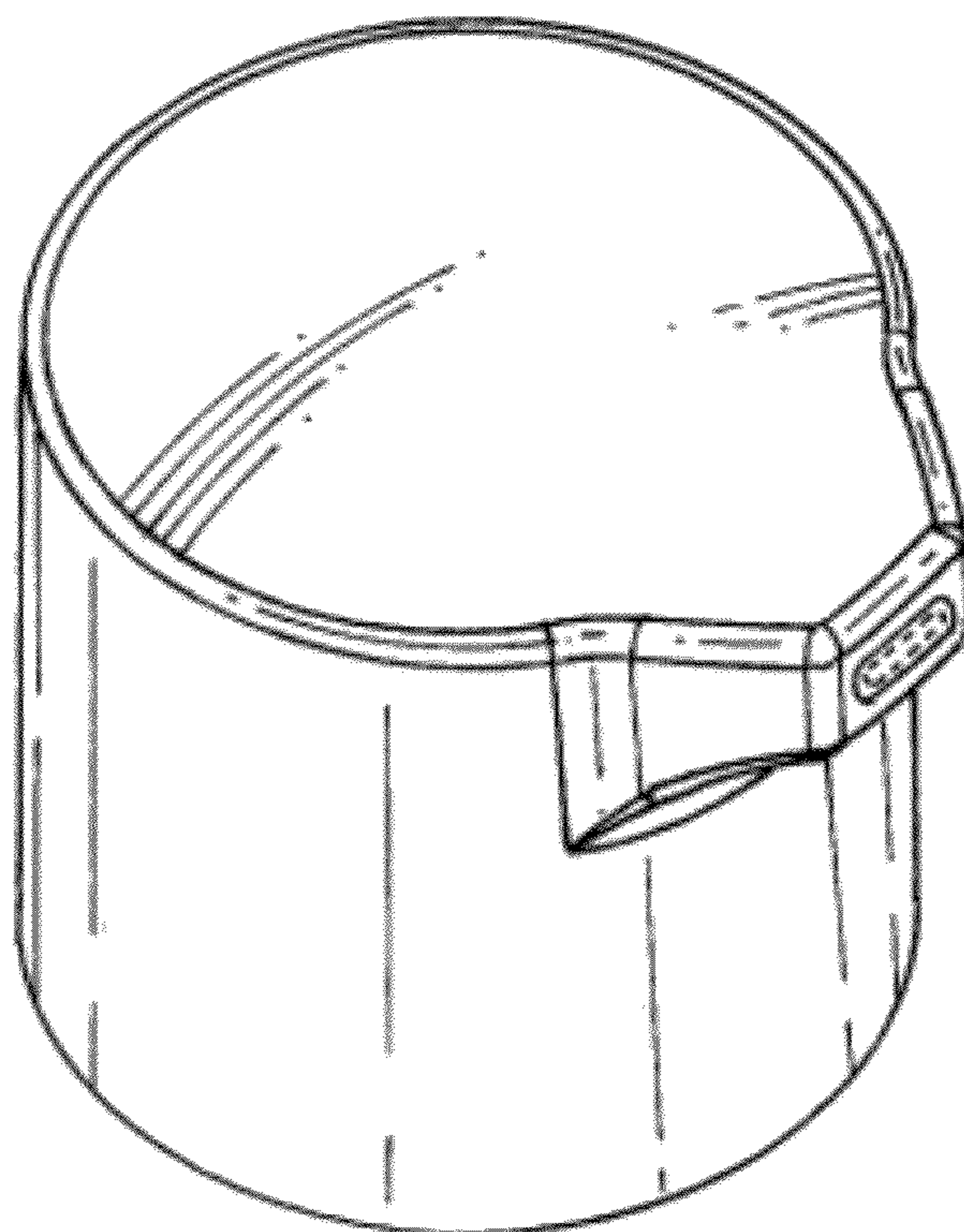

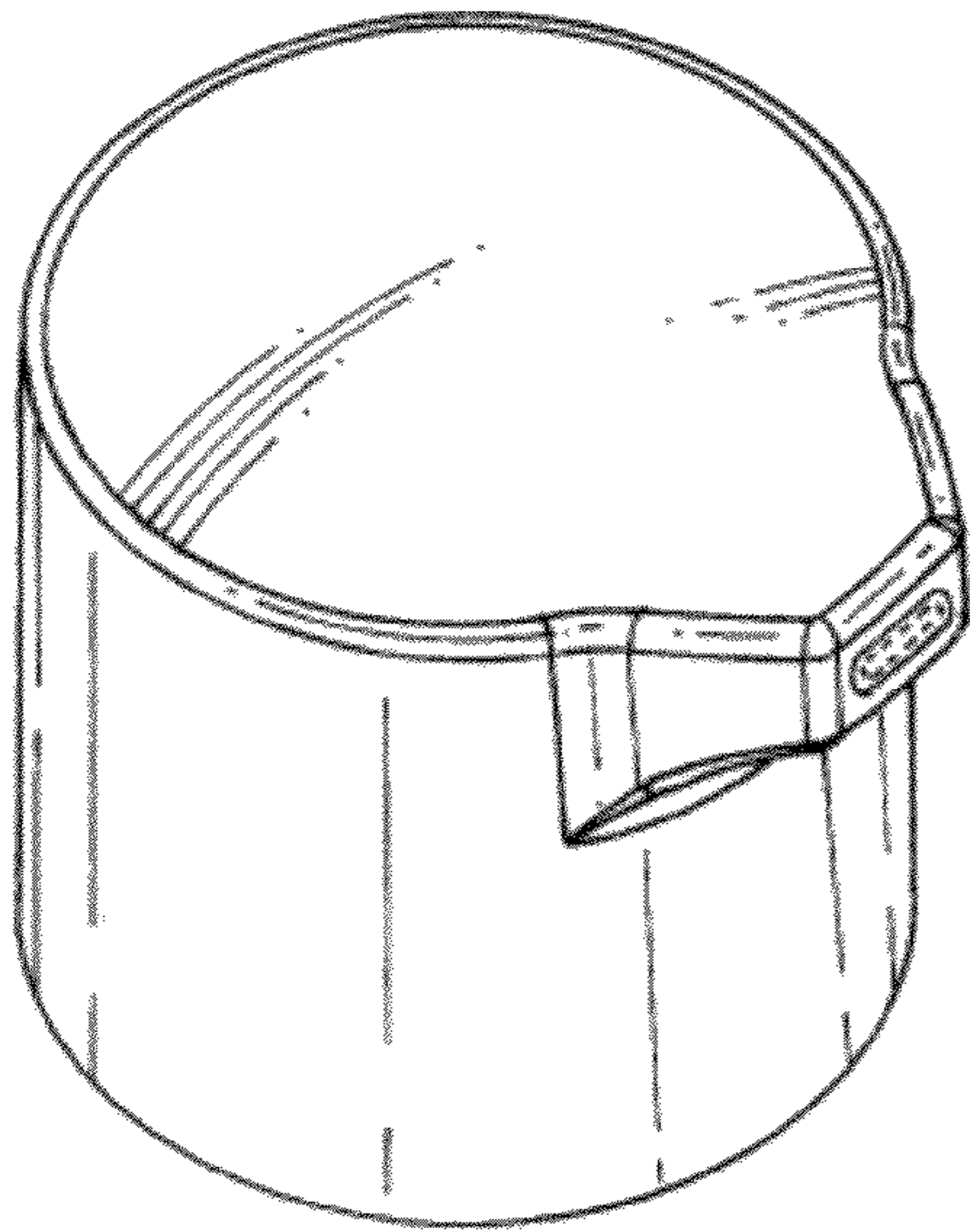

FIG. 1

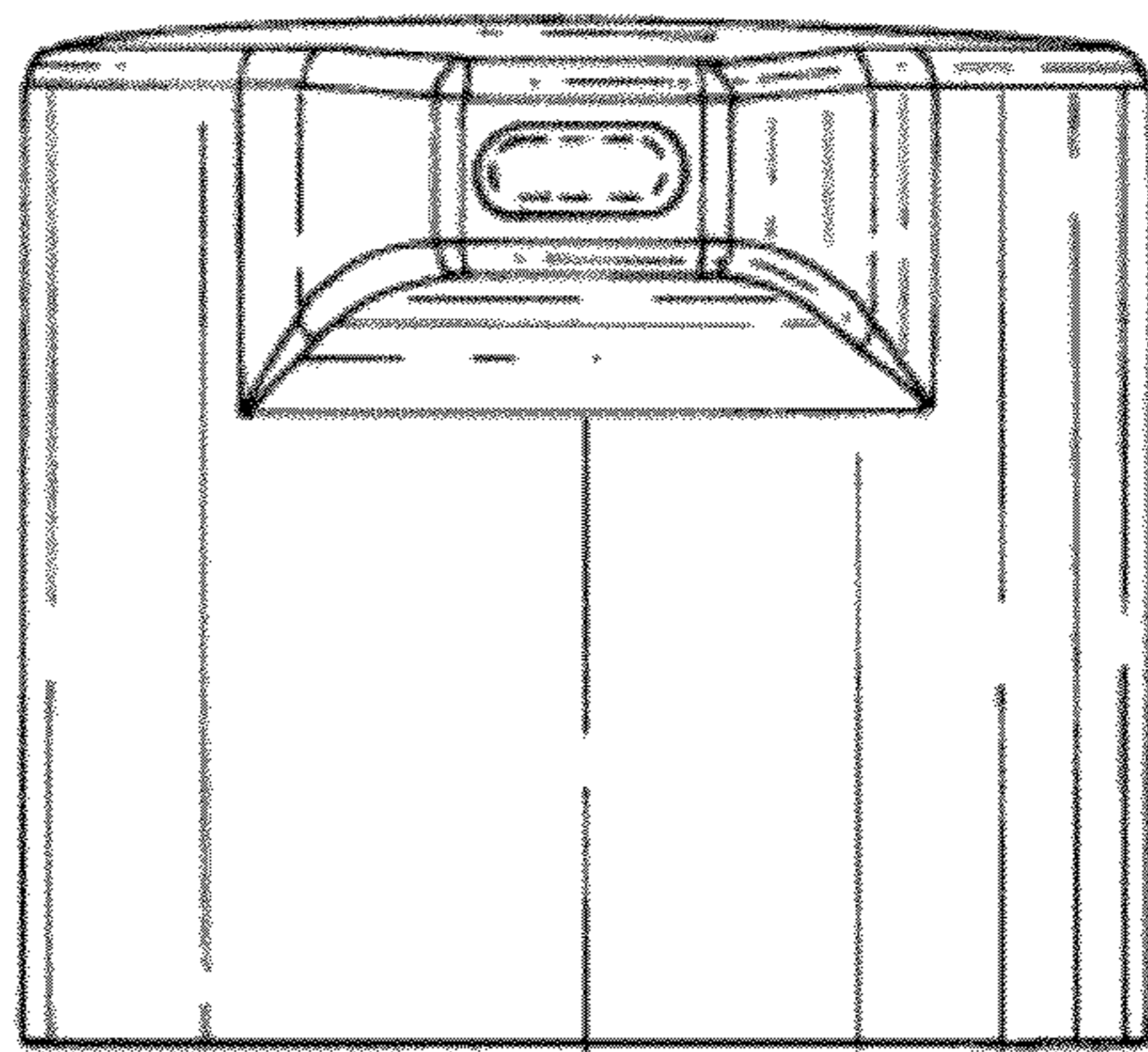

FIG. 2

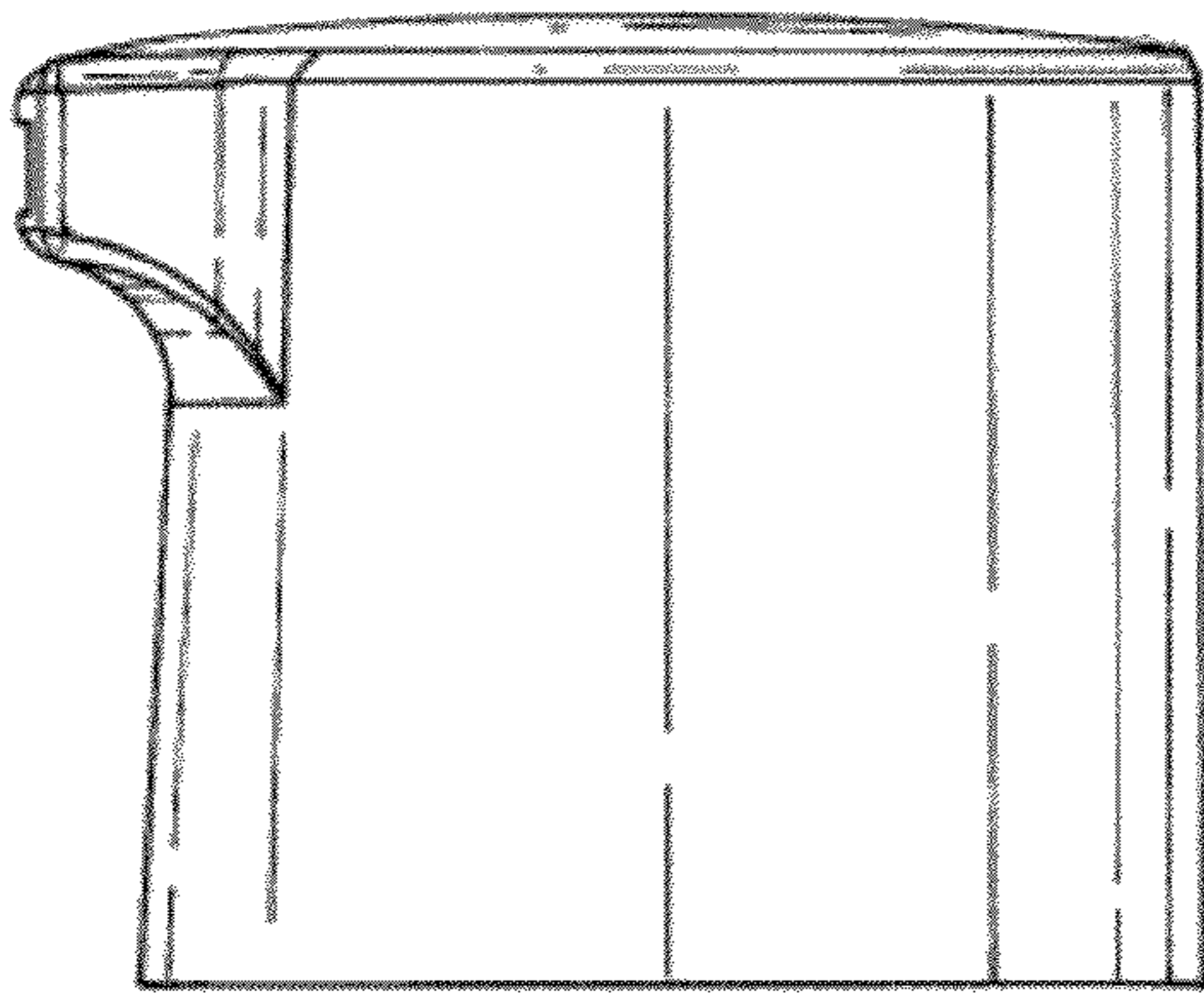

FIG. 3

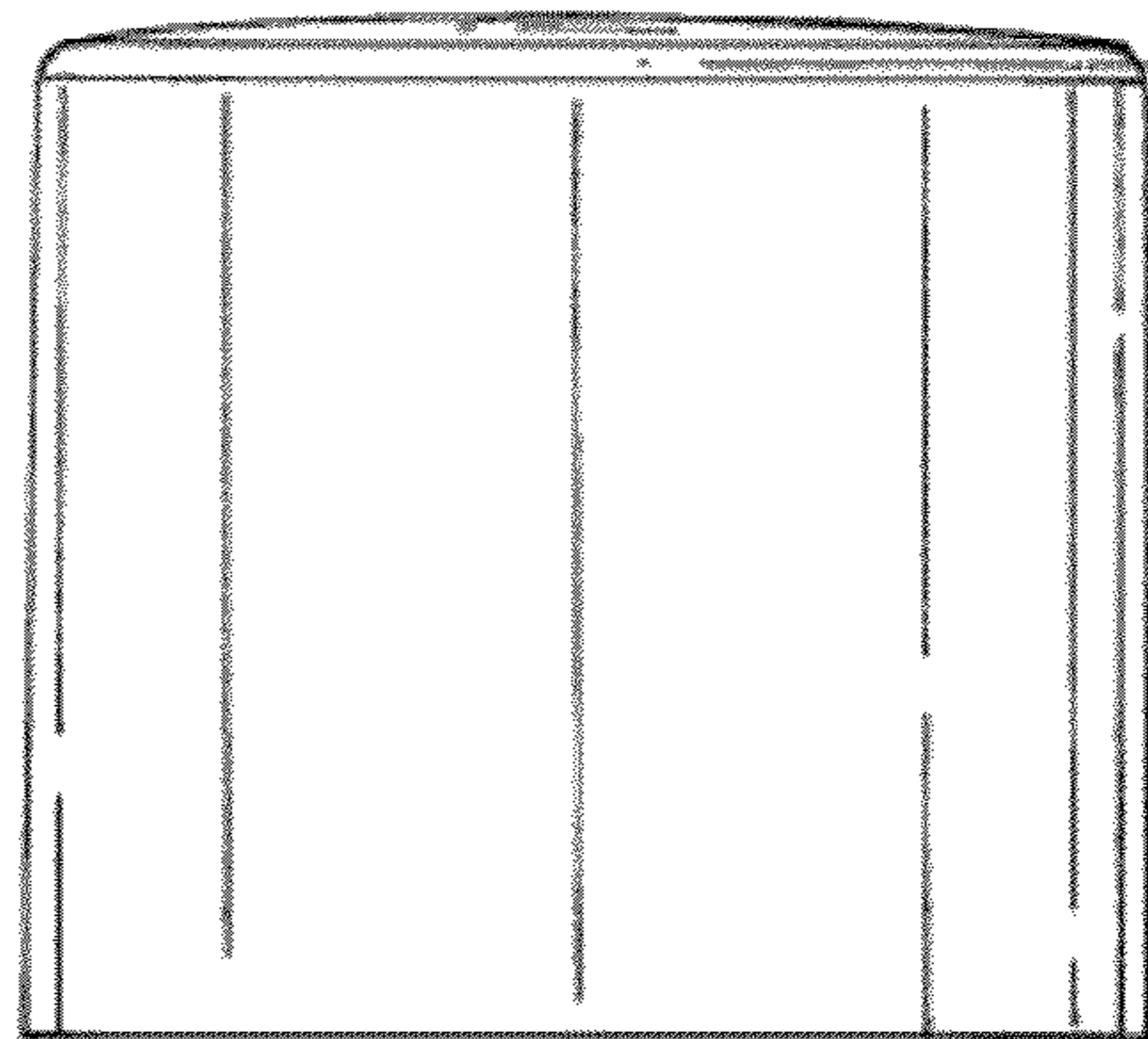

FIG. 4

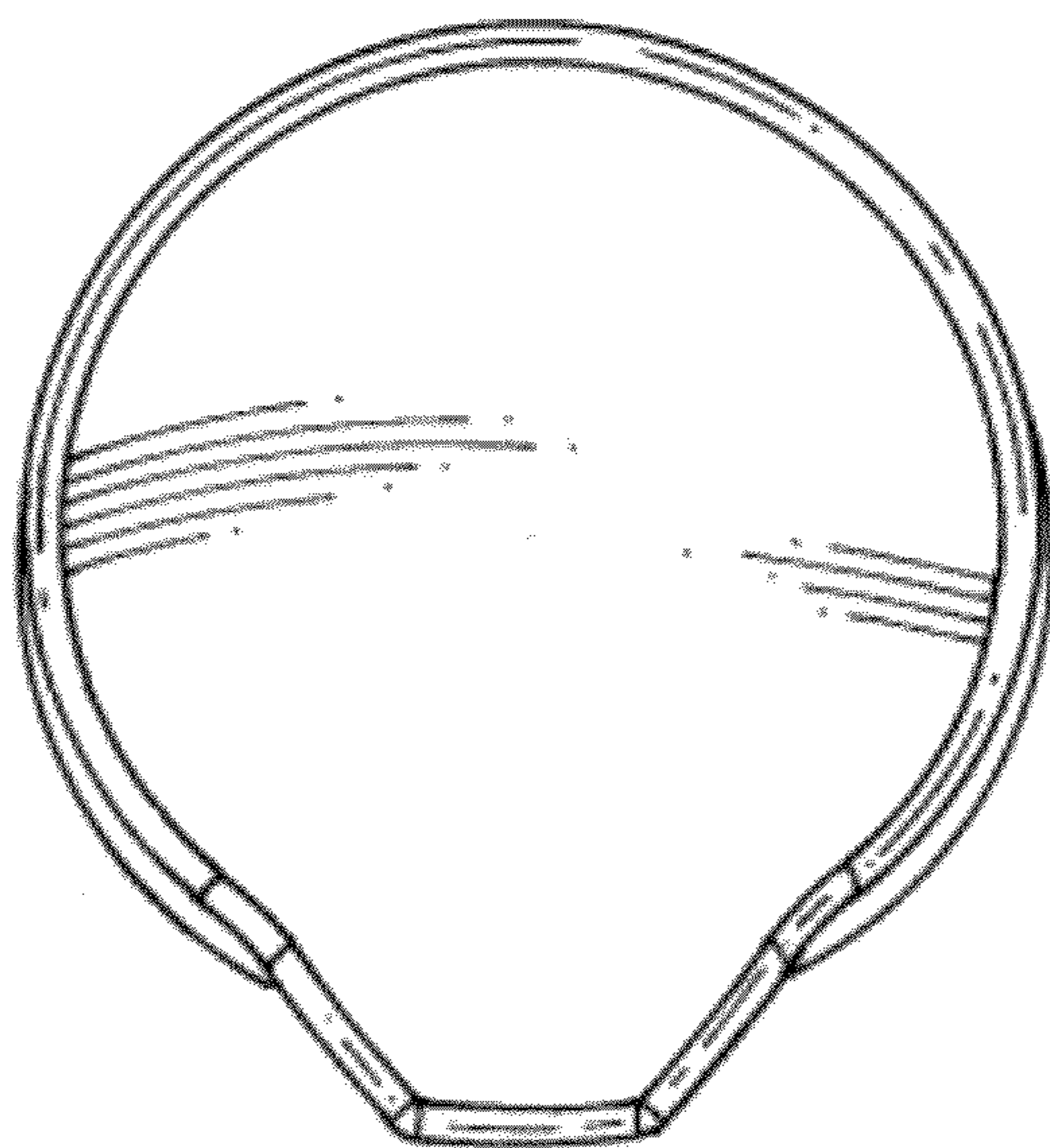

FIG. 5

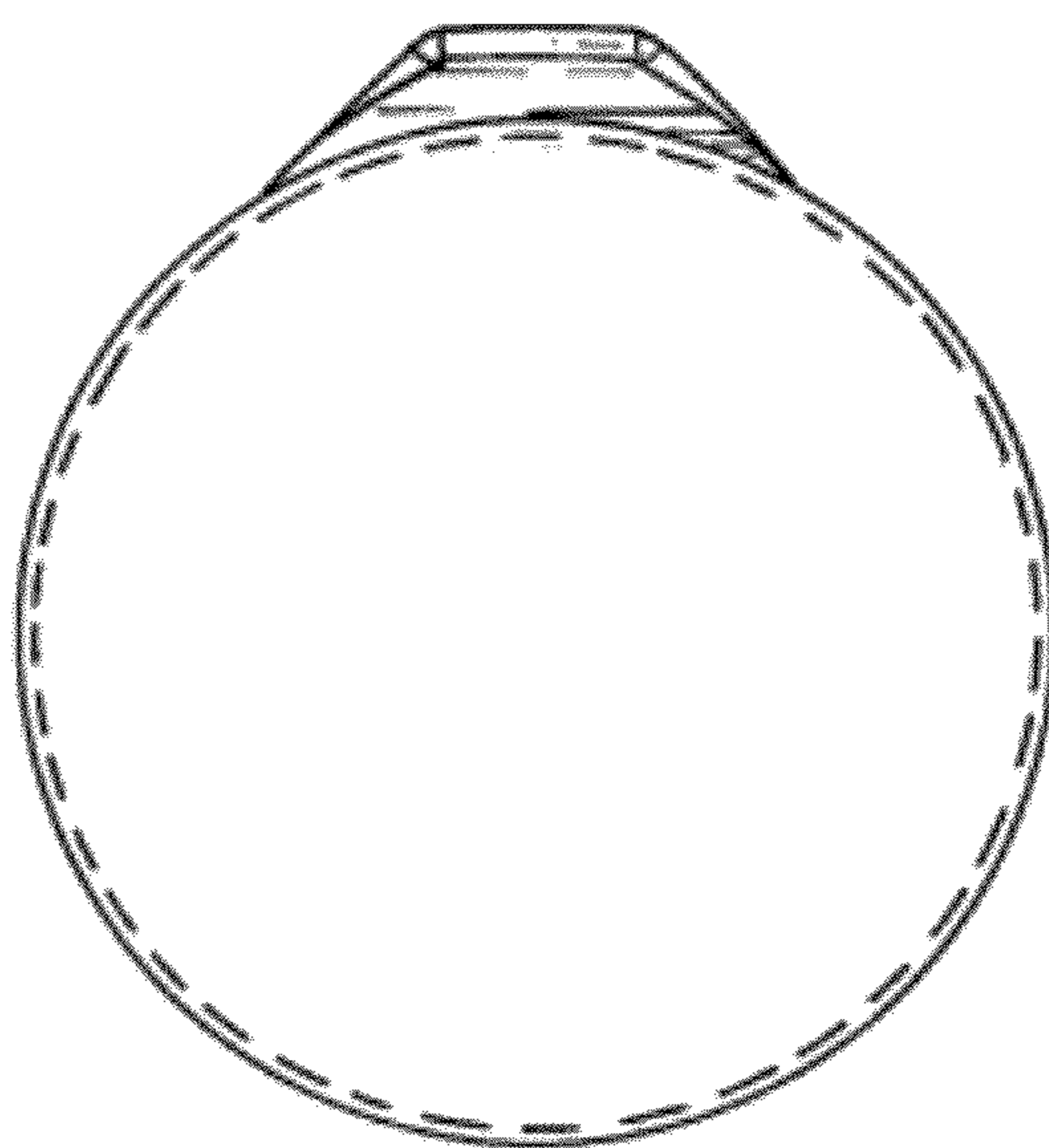

FIG. 6