



US00D666732S

(12) **United States Design Patent**  
**Caggiano et al.**

(10) **Patent No.:** **US D666,732 S**

(45) **Date of Patent:** **\*\* Sep. 4, 2012**

(54) **PERSONAL VIBRATOR IN THE SHAPE OF A MASCARA BRUSH HOUSED WITHIN A MASCARA CONTAINER**

D572,604 S \* 7/2008 Garofano et al. .... D9/718  
D652,527 S \* 1/2012 Marshall ..... D24/215  
D656,738 S \* 4/2012 Limongi et al. .... D4/128

\* cited by examiner

(75) Inventors: **Keith Caggiano**, Playa del Rey, CA (US); **Justin Ross**, Beverly Hills, CA (US)

*Primary Examiner* — Sandra Snapp

(74) *Attorney, Agent, or Firm* — Thomas I. Rozsa

(73) Assignee: **Momentum Management, LLC**, Torrance, CA (US)

(57) **CLAIM**

The ornamental design for a personal vibrator in the shape of a mascara brush housed within a mascara container, as shown and described.

(\*\*) Term: **14 Years**

(21) Appl. No.: **29/374,974**

**DESCRIPTION**

(22) Filed: **Nov. 2, 2011**

(51) **LOC (9) Cl.** ..... **28-03**

(52) **U.S. Cl.** ..... **D24/214**

(58) **Field of Classification Search** ..... D24/200,  
D24/211–215, 141; 601/27, 28, 33, 40, 46,  
601/47, 48, 63, 80, 99, 104, 112, 113, 114,  
601/119, 122, 125, 129, 134, 135, 137, DIG. 12,  
601/DIG. 13, DIG. 14, DIG. 15, DIG. 16,  
601/DIG. 17; D28/4, 8, 76, 85, 88

See application file for complete search history.

FIG. 1 is a side perspective view of the personal vibrator in the shape of a mascara brush housed within a mascara container with the cap in place, showing our design; FIG. 2 is bottom perspective view thereof; FIG. 3 is a front view thereof; FIG. 4 is a rear view thereof; FIG. 5 is a left side view thereof; FIG. 6 is a right side view thereof; FIG. 7 is a top view thereof; FIG. 8 is a bottom view thereof; FIG. 9 is a side perspective view of the personal vibrator in the shape of a mascara brush housed within a mascara container with the cap removed, showing our design; FIG. 10 is bottom perspective view thereof; FIG. 11 is a front view thereof; FIG. 12 is a rear view thereof; FIG. 13 is a left side view thereof; FIG. 14 is a right side view thereof; FIG. 15 is a top view thereof; and, FIG. 16 is a bottom view thereof.

(56) **References Cited**

U.S. PATENT DOCUMENTS

2,584,735 A \* 2/1952 Pancoast ..... 401/26  
2,653,598 A \* 9/1953 Torino ..... 601/141  
4,115,893 A \* 9/1978 Nakata et al. .... 15/110  
D293,472 S \* 12/1987 Chrones et al. .... D24/211  
D345,054 S \* 3/1994 Spence, Jr. .... D4/104  
D350,851 S \* 9/1994 Spence, Jr. .... D4/104  
D376,853 S \* 12/1996 Hsia ..... D24/214  
D501,048 S \* 1/2005 Hacker ..... D24/214  
D510,440 S \* 10/2005 Huang ..... D24/211

**1 Claim, 10 Drawing Sheets**

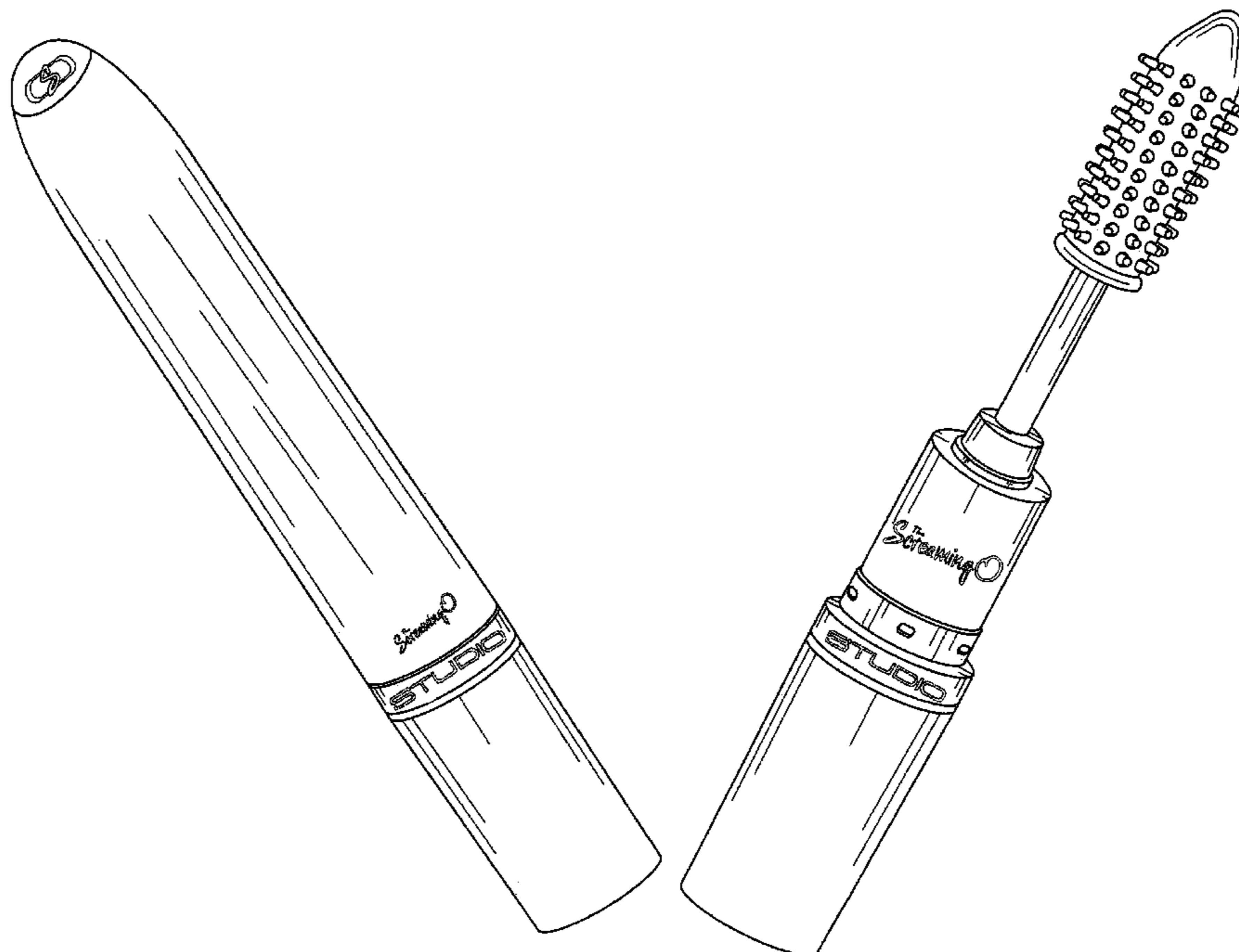

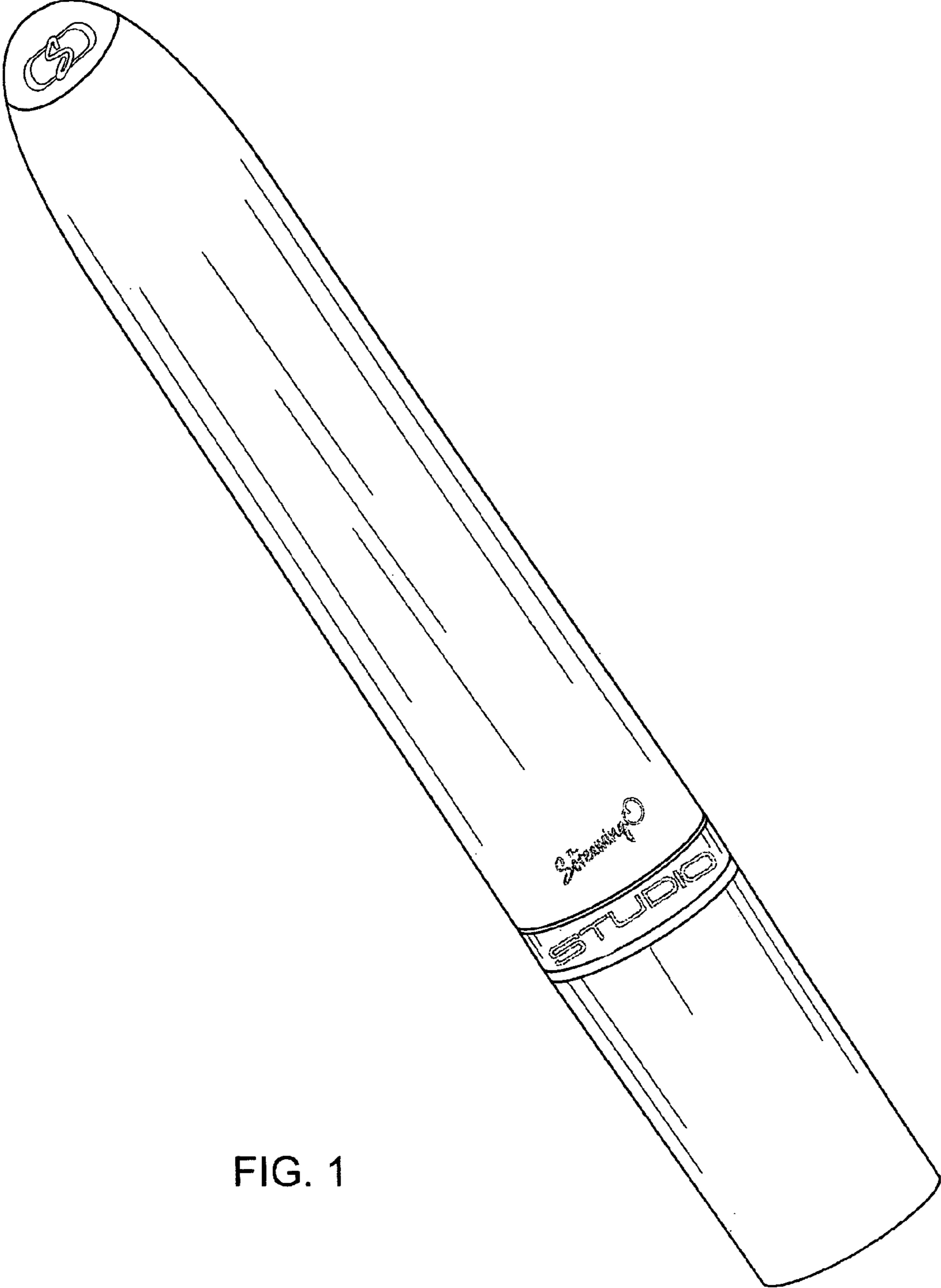

FIG. 1

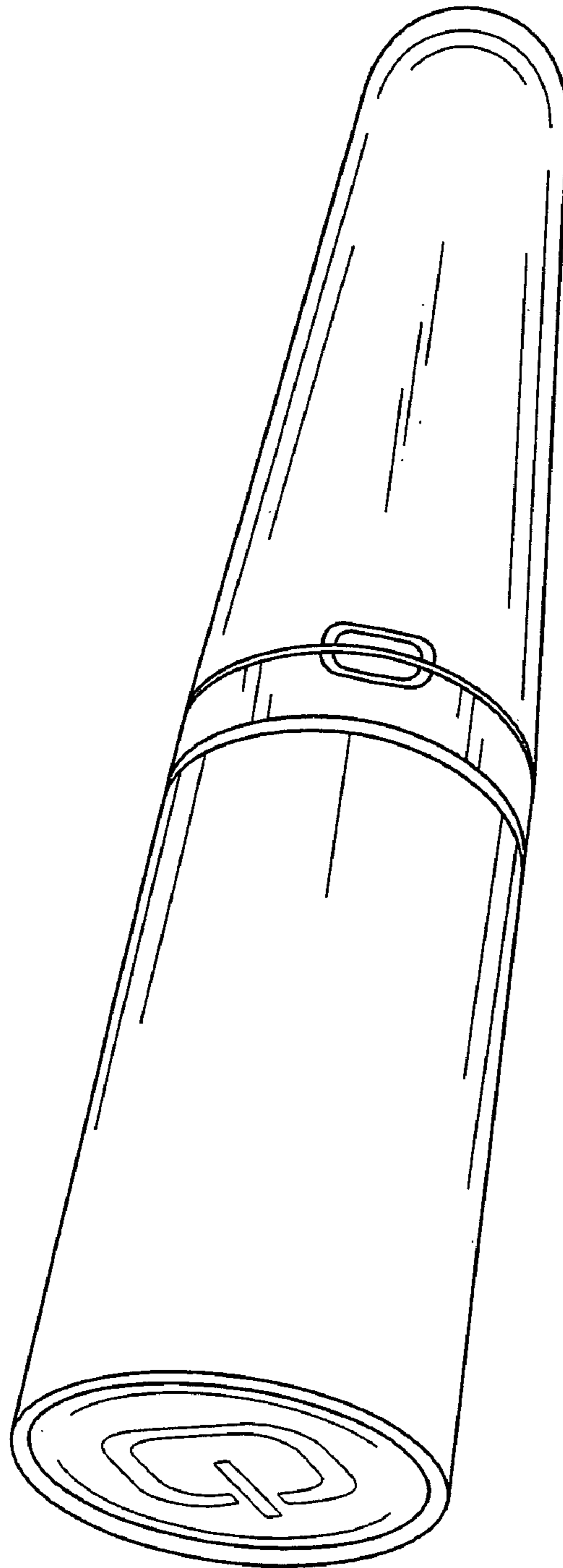

FIG. 2

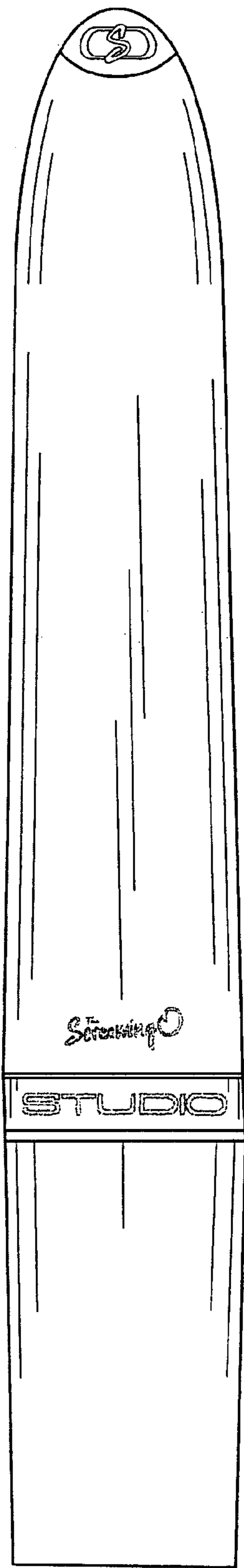

FIG. 3

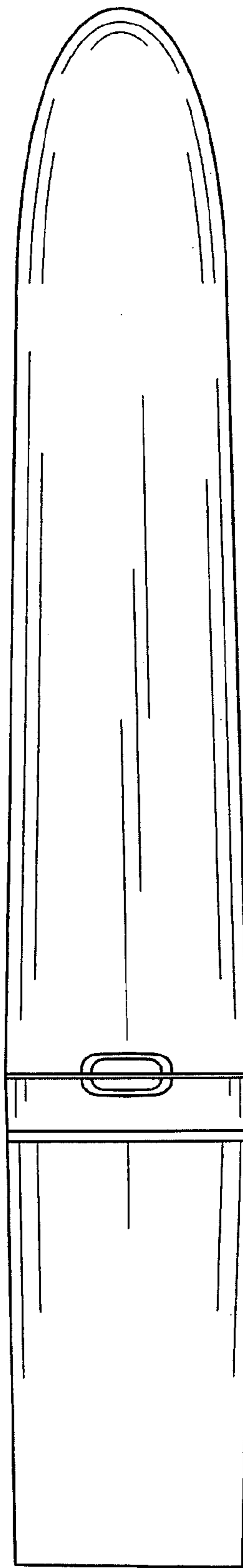

FIG. 4

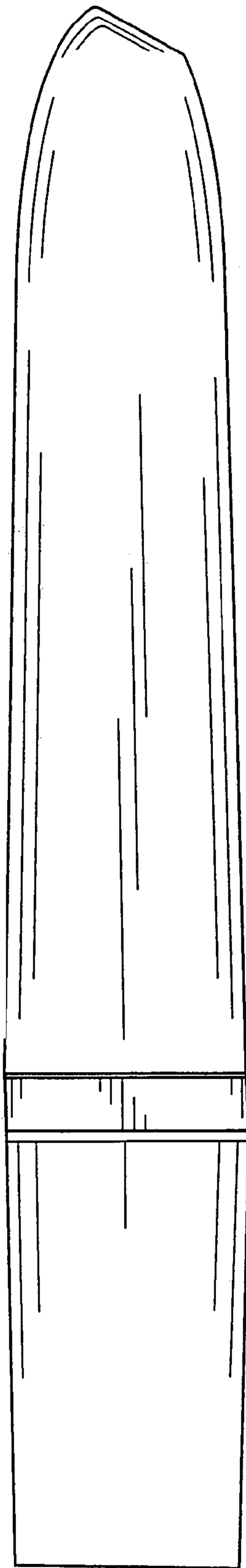

FIG. 5

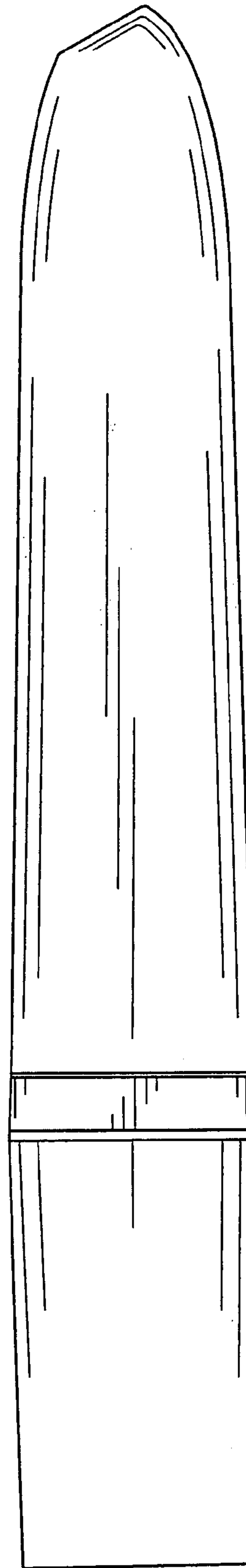

FIG. 6

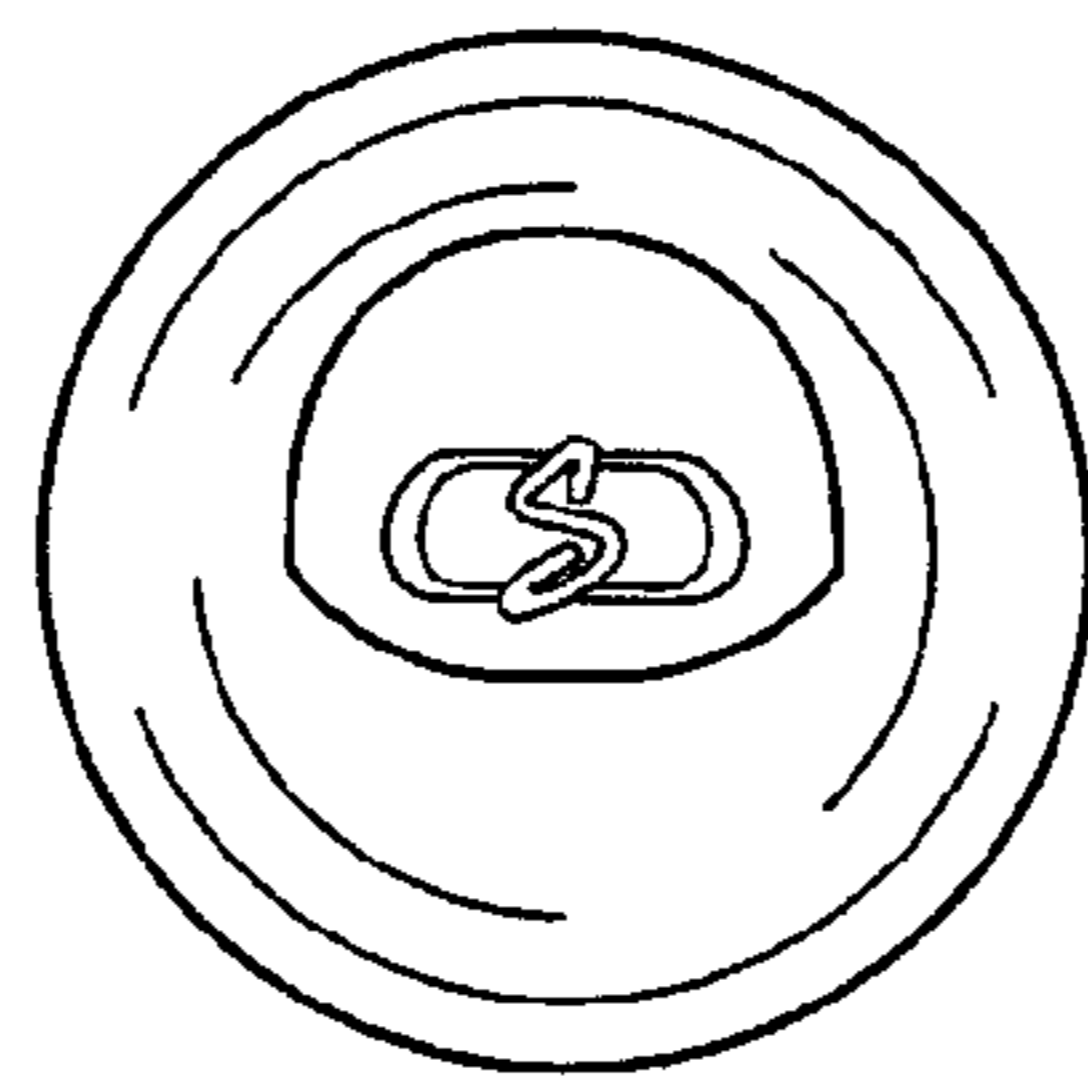

FIG. 7

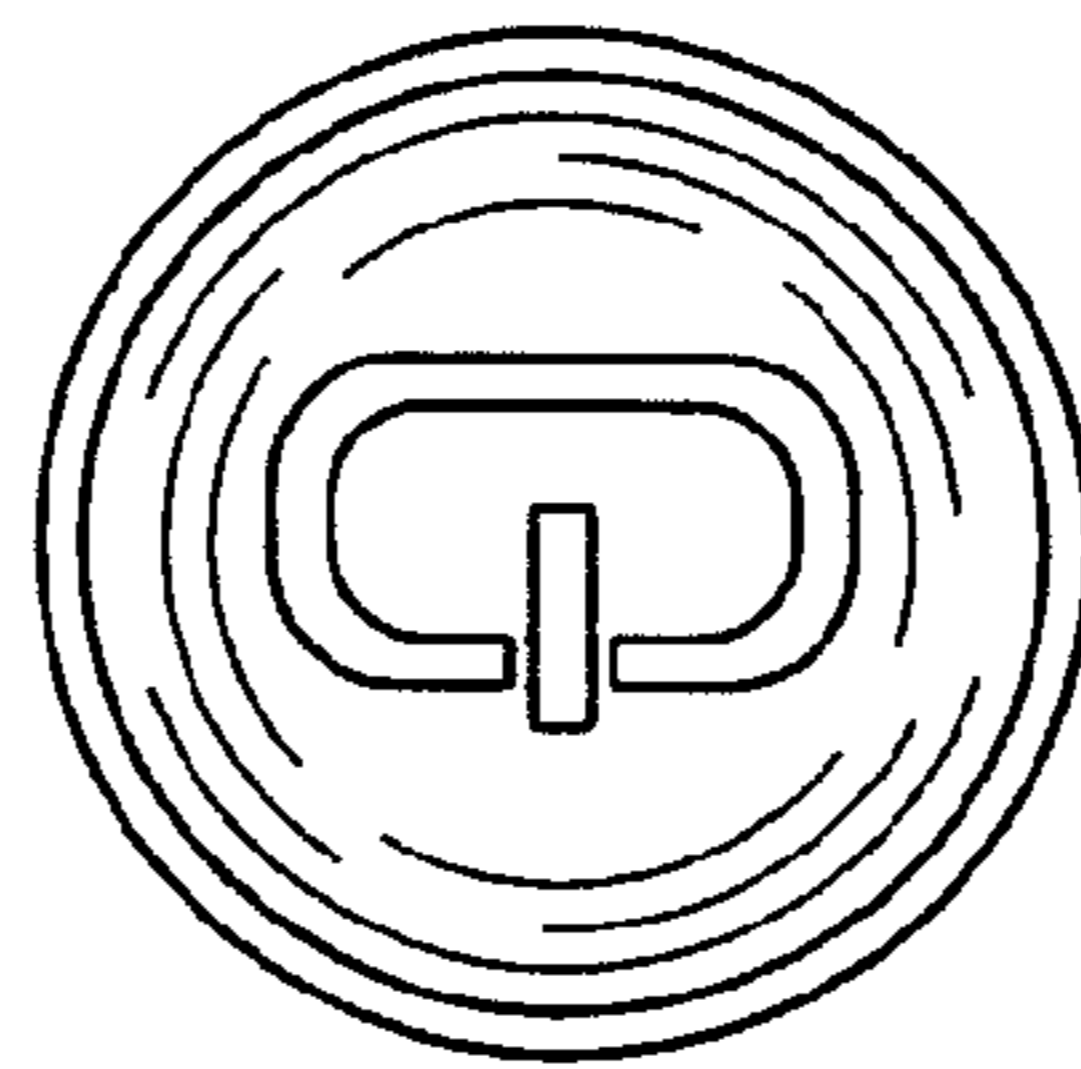

FIG. 8



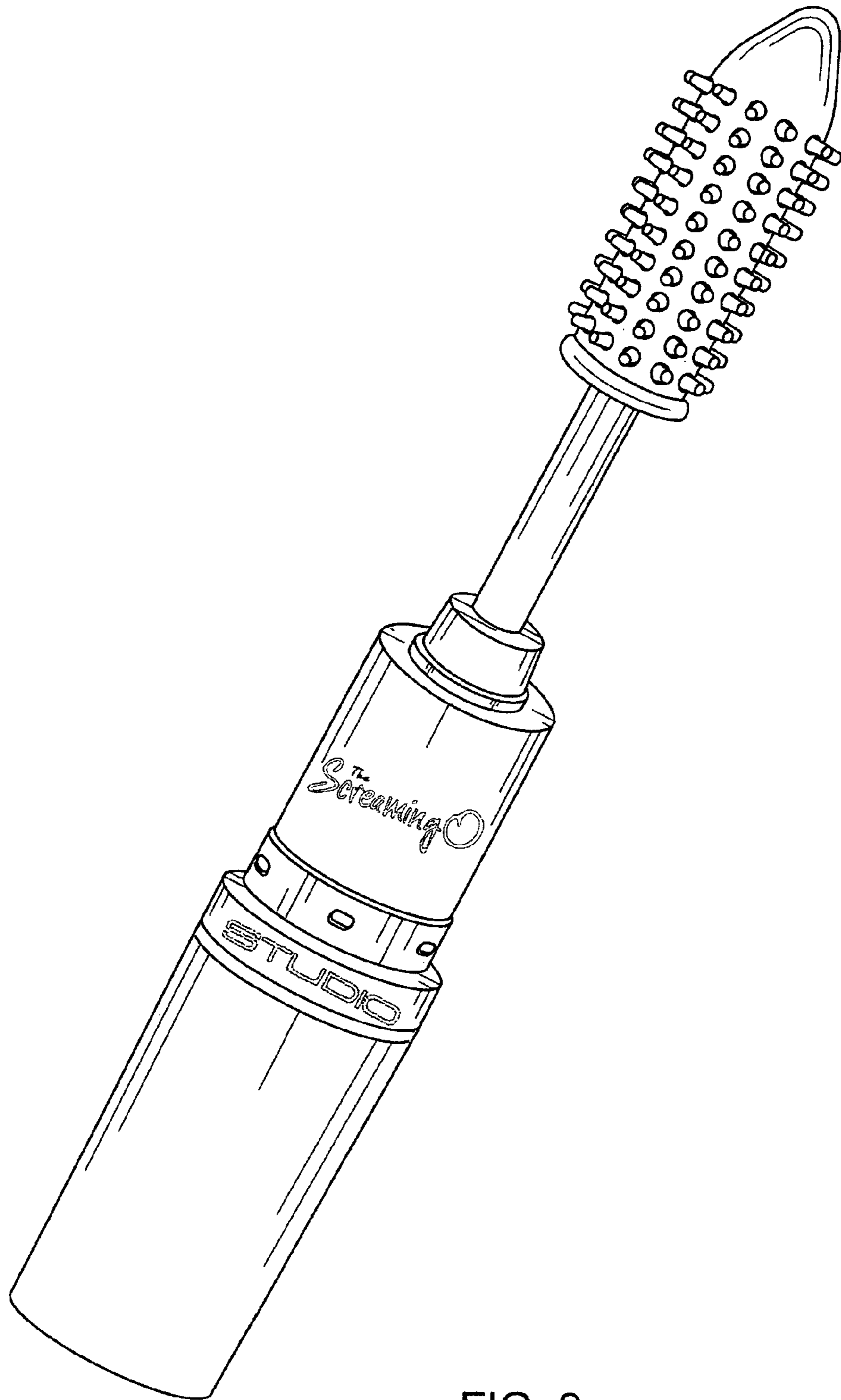

FIG. 9

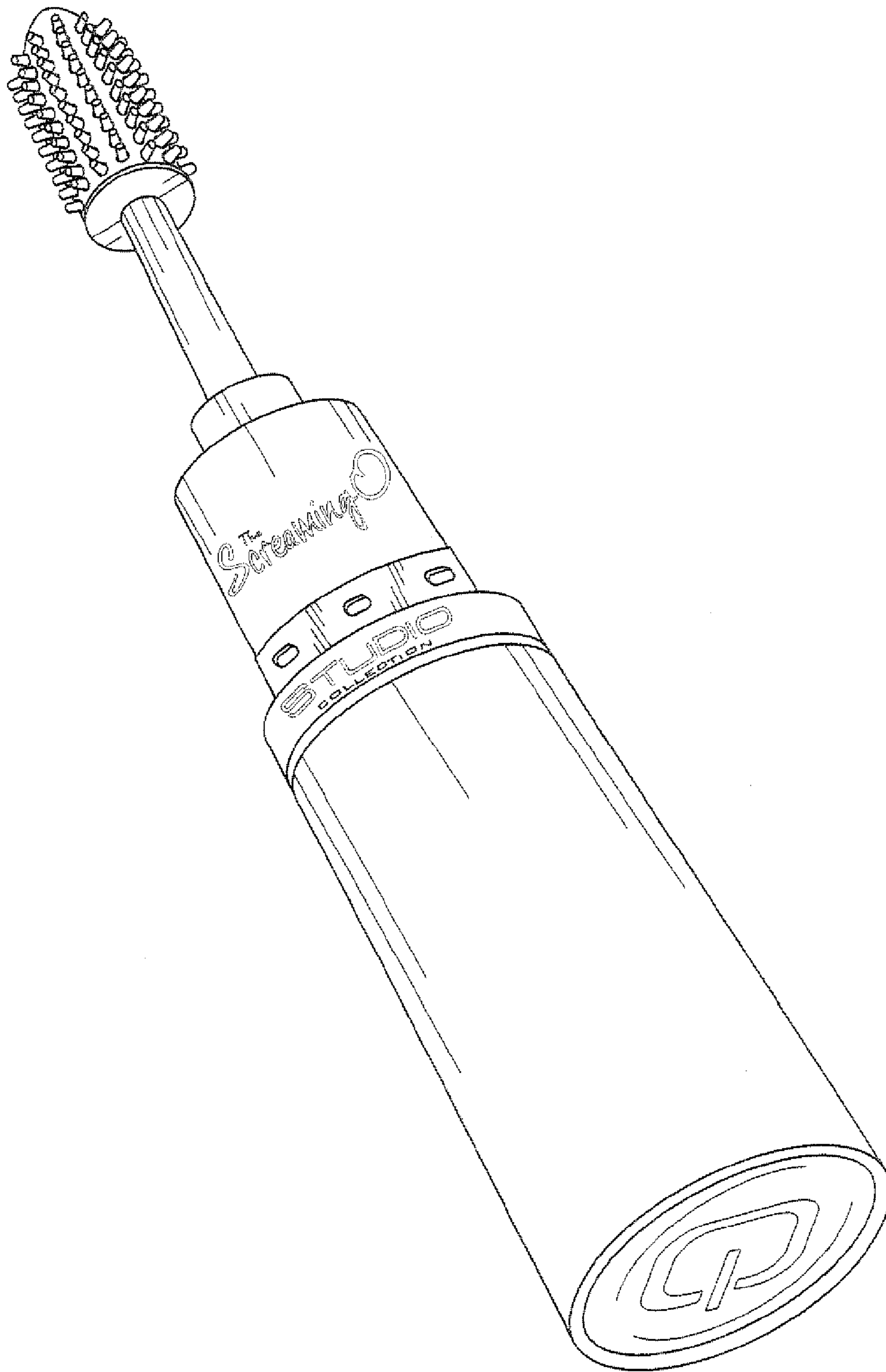

FIG. 10



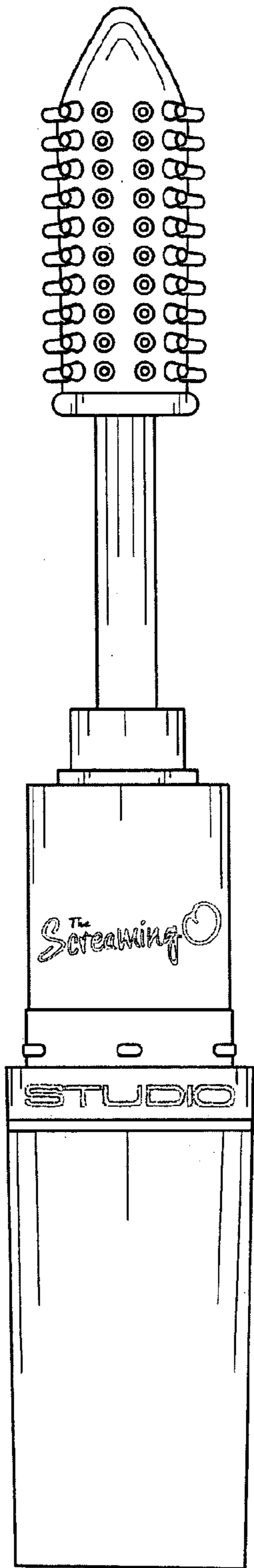

FIG. 11

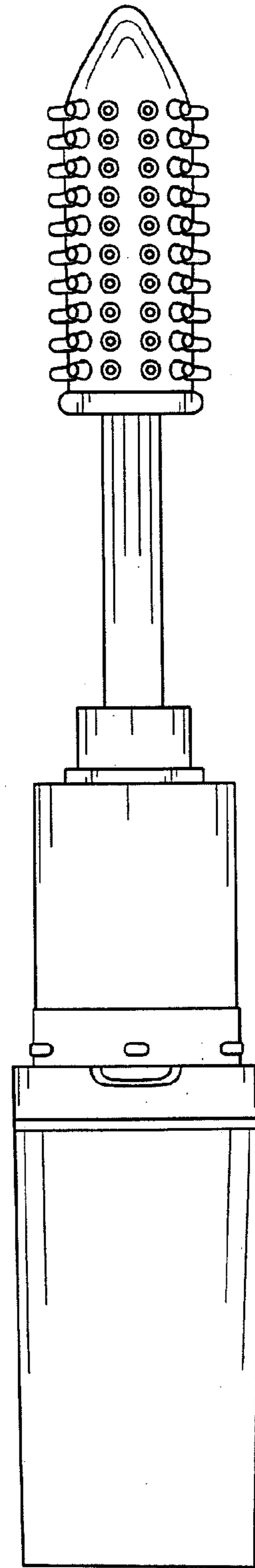

FIG. 12

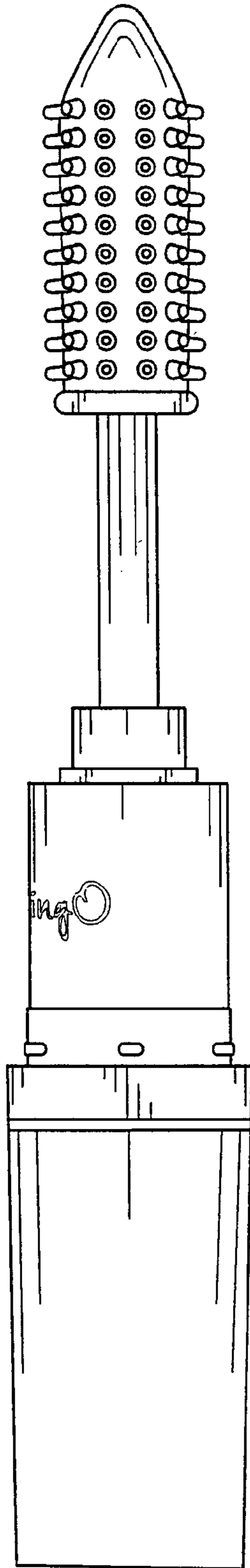

FIG. 13

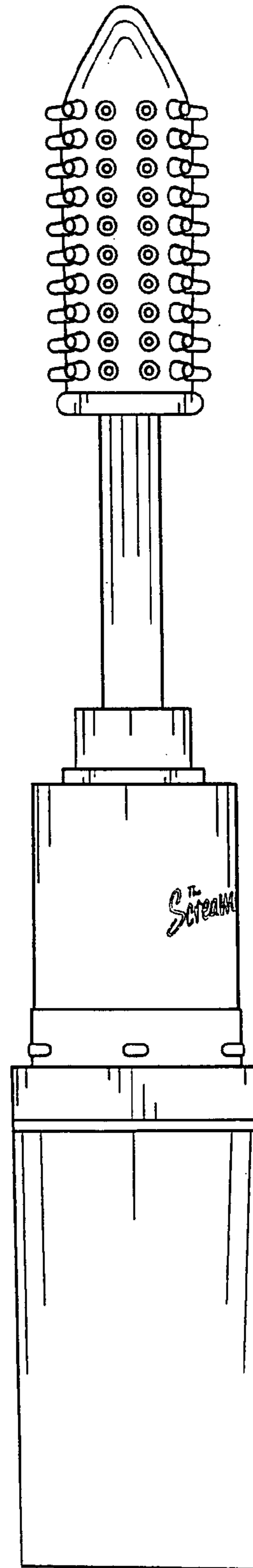

FIG. 14

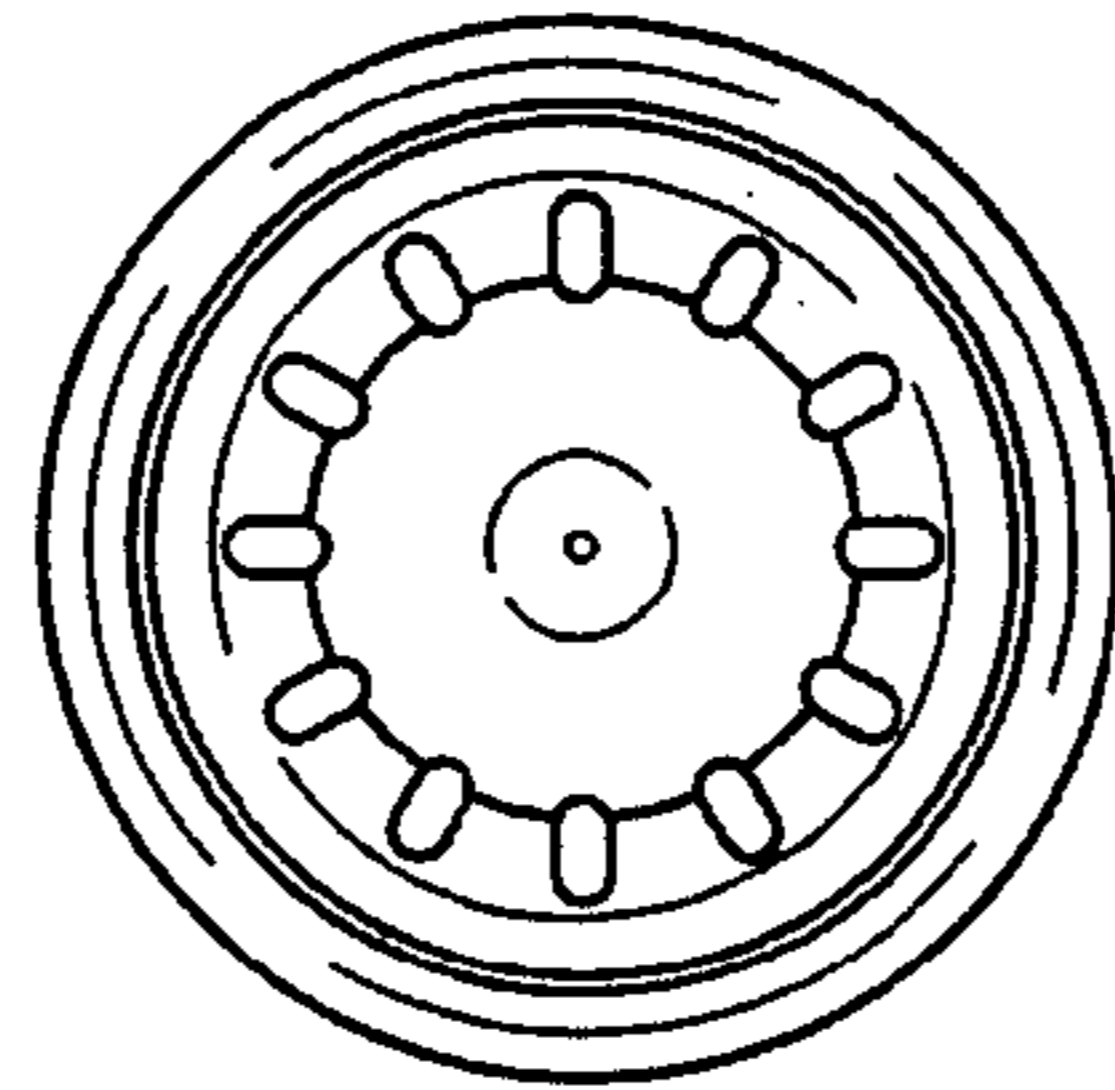

FIG. 15

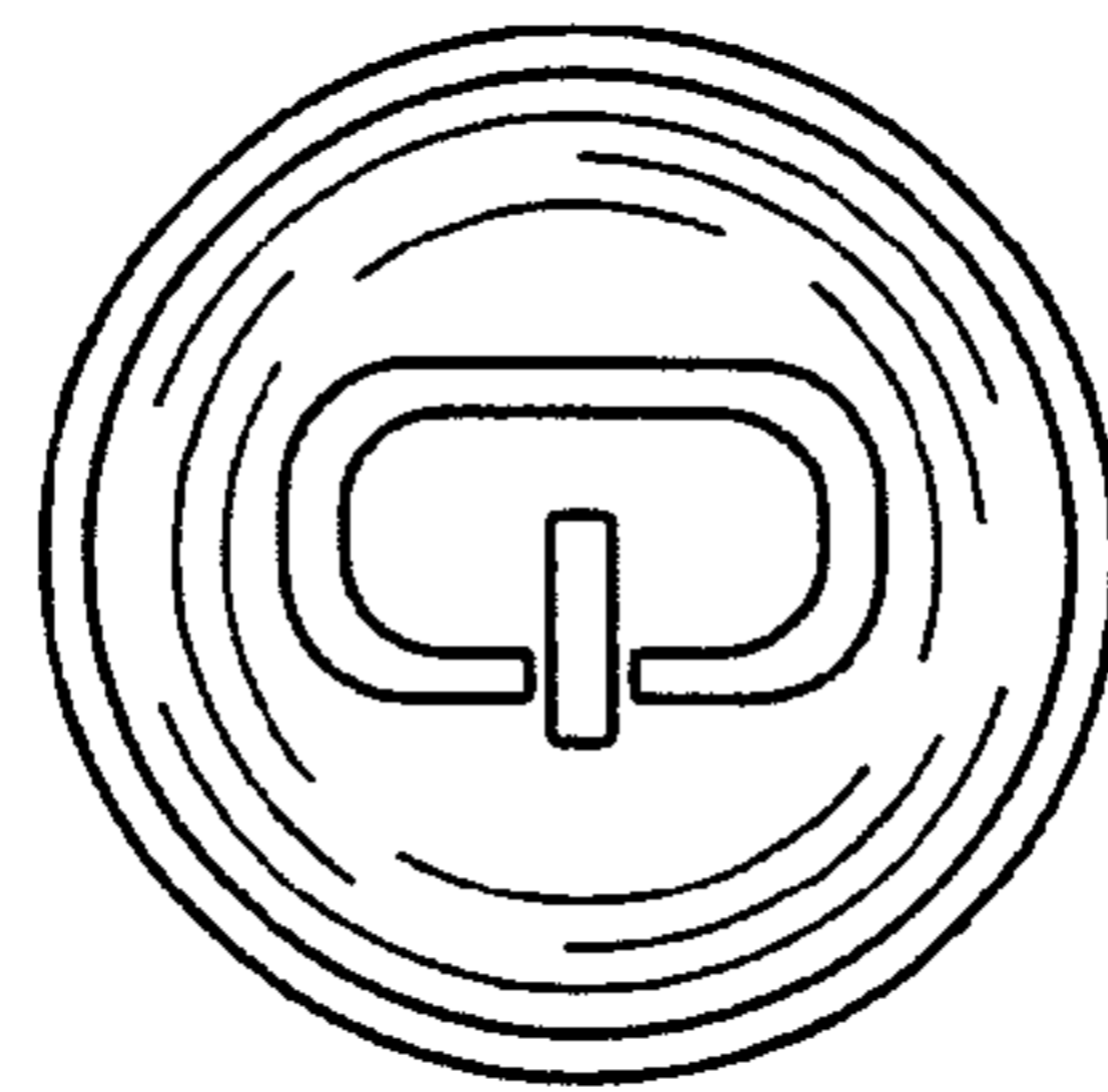

FIG. 16