

US00D666729S

(12) **United States Design Patent**
Fisher et al.

(10) **Patent No.:** **US D666,729 S**
(45) **Date of Patent:** **** Sep. 4, 2012**

(54) **ELECTRONIC READER FOR MEDICAL ENVIRONMENTS**

(76) Inventors: **Stanley Fisher**, Durham, NC (US);
Stephen S. Jackson, Chapel Hill, NC (US)

(**) Term: **14 Years**

(21) Appl. No.: **29/396,973**

(22) Filed: **Jul. 8, 2011**

Related U.S. Application Data

(60) Continuation of application No. 29/380,885, filed on Dec. 13, 2010, now Pat. No. Des. 641,481, which is a division of application No. 29/359,700, filed on Apr. 14, 2010, now Pat. No. Des. 631,165.

(51) **LOC (9) Cl.** **24-01**

(52) **U.S. Cl.** **D24/186**

(58) **Field of Classification Search** D24/185-186;
D10/104, 106, 109, 40, 70, 15; D13/158,
D13/162, 164, 165, 168, 170, 177, 160, 154,
D13/137.1, 137.2, 137.3, 137.4, 139.1, 139.2,
D13/139.8, 139.3; 340/573.4, 555-556,
340/600; 250/353, 349, 342, 370; 600/473;
439/105, 535; 315/360; 363/146; 174/66
See application file for complete search history.

(56) **References Cited**

U.S. PATENT DOCUMENTS

D301,868	S	*	6/1989	Schwartz	D13/162
D309,890	S	*	8/1990	Cheng	D13/165
D310,063	S	*	8/1990	Cheng	D13/168
D310,814	S	*	9/1990	Rosenbaum et al.	D13/158
D314,368	S	*	2/1991	Schwartz	D13/165
D323,297	S	*	1/1992	Zeller	D10/15
D324,670	S	*	3/1992	Ferraro	D13/137.4
D325,370	S	*	4/1992	Belcher	D13/137.3
D325,562	S	*	4/1992	Smith, Sr.	D13/139.1
D329,422	S	*	9/1992	Fujiyoshi	D13/139.1
D354,943	S	*	1/1995	Williams et al.	D13/137.1
D357,460	S	*	4/1995	Lovett	D13/139.8

D361,315	S	*	8/1995	Wedell et al.	D13/160
D399,495	S	*	10/1998	Bachschnid	D13/177
D401,555	S	*	11/1998	Tam	D13/137.3
D405,760	S	*	2/1999	Yu	D13/139.3
6,045,374	A	*	4/2000	Candeloro	439/105
6,049,281	A	*	4/2000	Osterweil	340/573.4
D431,027	S	*	9/2000	Armstrong	D13/162
D435,523	S	*	12/2000	Ciornei et al.	D13/164
D436,082	S	*	1/2001	Jilani	D13/158
D443,589	S	*	6/2001	Tong et al.	D13/137.2

(Continued)

OTHER PUBLICATIONS

Notice of Allowance for U.S. Appl. No. 29/359,700 mailed Sep. 16, 2010.

(Continued)

Primary Examiner — T. Chase Nelson

Assistant Examiner — Mark Cavanna

(74) *Attorney, Agent, or Firm* — K&L Gates LLP

(57) **CLAIM**

The ornamental design for electronic reader for medical environments, as shown and described.

DESCRIPTION

FIG. 1 is a front perspective view of another embodiment of the electronic reader showing our new design;

FIG. 2 is a front view thereof (the rear view thereof is disclaimed);

FIG. 3 is a side view thereof;

FIG. 4 is an opposing side view;

FIG. 5 is a top end view thereof;

FIG. 6 is a bottom end view thereof; and,

FIG. 7 is a front perspective environmental view thereof illustrating the electronic reader in an exemplary medical (e.g., hospital) use environment.

The broken lines showing an example medical environment are included for the purpose of illustrating portions of the electronic reader for medical environments, that form no part of the claimed design.

1 Claim, 5 Drawing Sheets

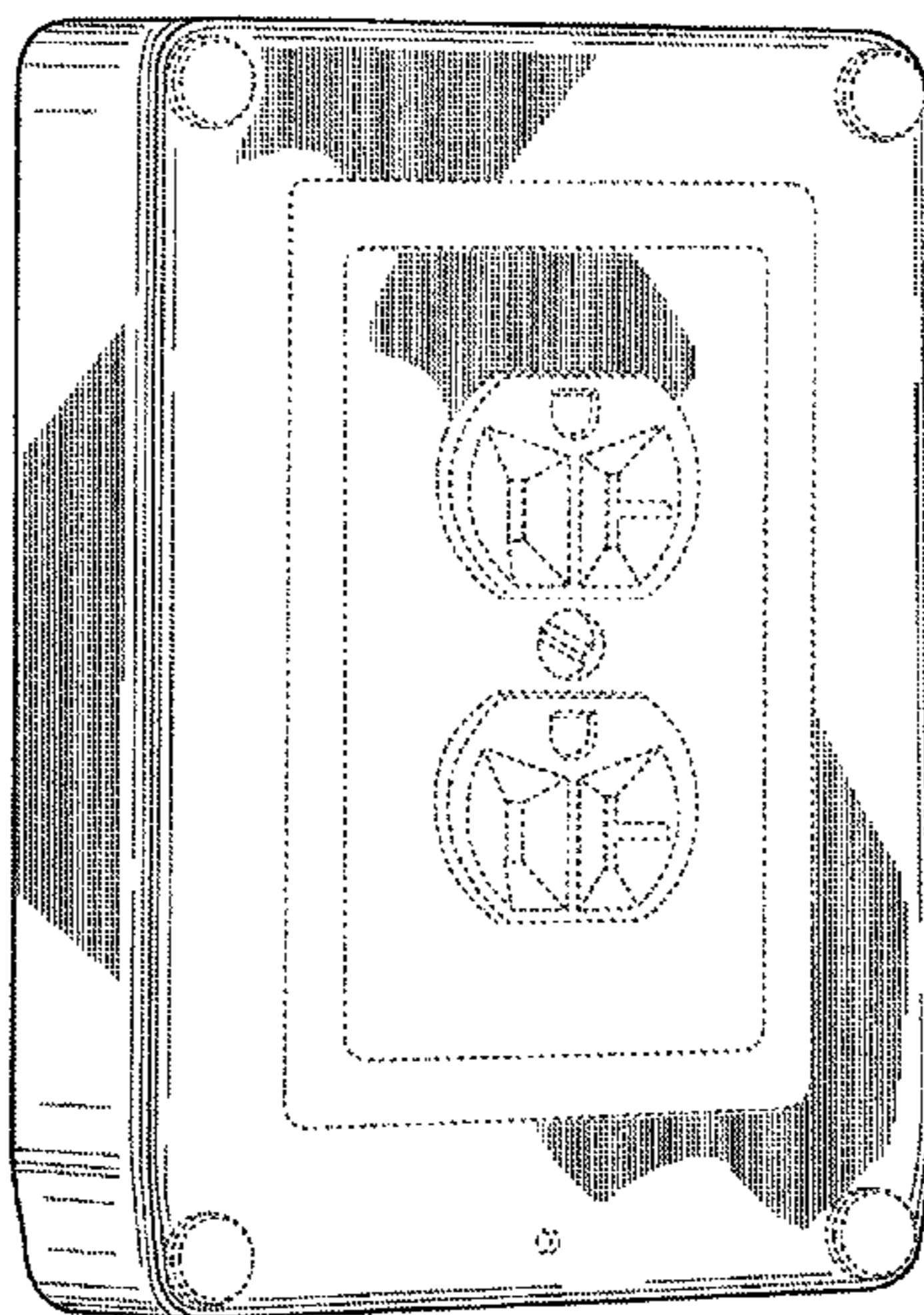

US D666,729 S

Page 2

U.S. PATENT DOCUMENTS

D455,406 S * 4/2002 Pinchuk D13/165
D486,126 S * 2/2004 Aromin D13/137.3
D500,686 S * 1/2005 Stekelenburg D10/40
D500,687 S * 1/2005 Morrison et al. D10/40
D514,067 S * 1/2006 Lee D13/137.2
D523,397 S * 6/2006 Maglionario et al. D13/137.2
D535,204 S * 1/2007 Bender et al. D10/106.8
D543,939 S * 6/2007 Burke D13/137.2
D547,272 S * 7/2007 Ng D13/137.2
D565,984 S * 4/2008 Lidong et al. D10/106.8
D567,950 S * 4/2008 Savage, Jr. D24/186
D568,253 S * 5/2008 Gorman D13/154
D581,870 S * 12/2008 Zhou D13/137.2
D582,346 S * 12/2008 Zhou D13/137.2
D583,688 S * 12/2008 Guercio D10/70
D588,035 S * 3/2009 Schmalz et al. D10/106.8
D588,076 S * 3/2009 Ollila D13/168
D590,352 S * 4/2009 Jacoby et al. D13/164
D595,229 S * 6/2009 LaGrotta D13/137.2
D595,604 S * 7/2009 Schmalz et al. D10/106.8
D596,140 S * 7/2009 Hollner D13/164
D603,346 S * 11/2009 Murray et al. D13/162
D608,302 S * 1/2010 Liu D13/164
D610,554 S * 2/2010 Lanfear et al. D13/162

D611,005 S * 3/2010 Lanfear et al. D13/162
D618,808 S 6/2010 Fisher et al.
D631,165 S 1/2011 Fisher et al.
D641,481 S 7/2011 Fisher et al.
2002/0072272 A1 * 6/2002 King 439/535
2003/0151938 A1 * 8/2003 Liao 363/146
2004/0121648 A1 * 6/2004 Voros 439/535
2005/0242753 A1 * 11/2005 Morrison et al. 315/360
2008/0289844 A1 * 11/2008 Dutton, Jr. 174/66

OTHER PUBLICATIONS

Notice of Allowance for U.S. Appl. No. 29/380,885 mailed Mar. 7, 2011.

Non-Final Office Action for U.S. Appl. No. 29/396,972, mailed Oct. 27, 2011.

Non-Final Office Action for U.S. Appl. No. 29/396,974, mailed Oct. 26, 2011.

Ex Parte Quayle Action for U.S. Appl. No. 29/396,975, mailed Oct. 26, 2011.

U.S. Appl. No. 29/396,972, filed Jul. 8, 2011.

U.S. Appl. No. 29/396,974, filed Jul. 8, 2011.

U.S. Appl. No. 29/396,975, filed Jul. 8, 2011.

* cited by examiner

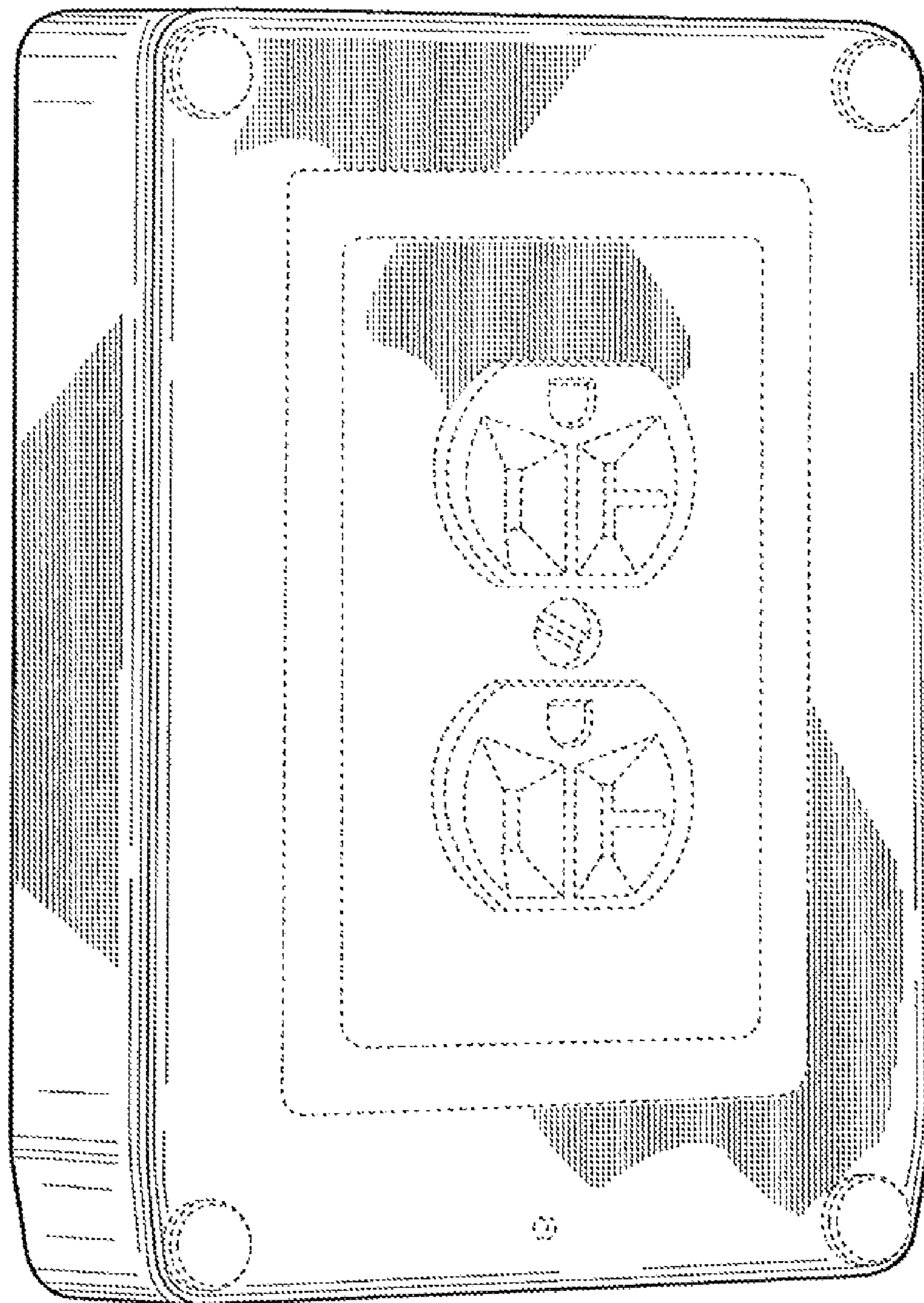

FIG. 1

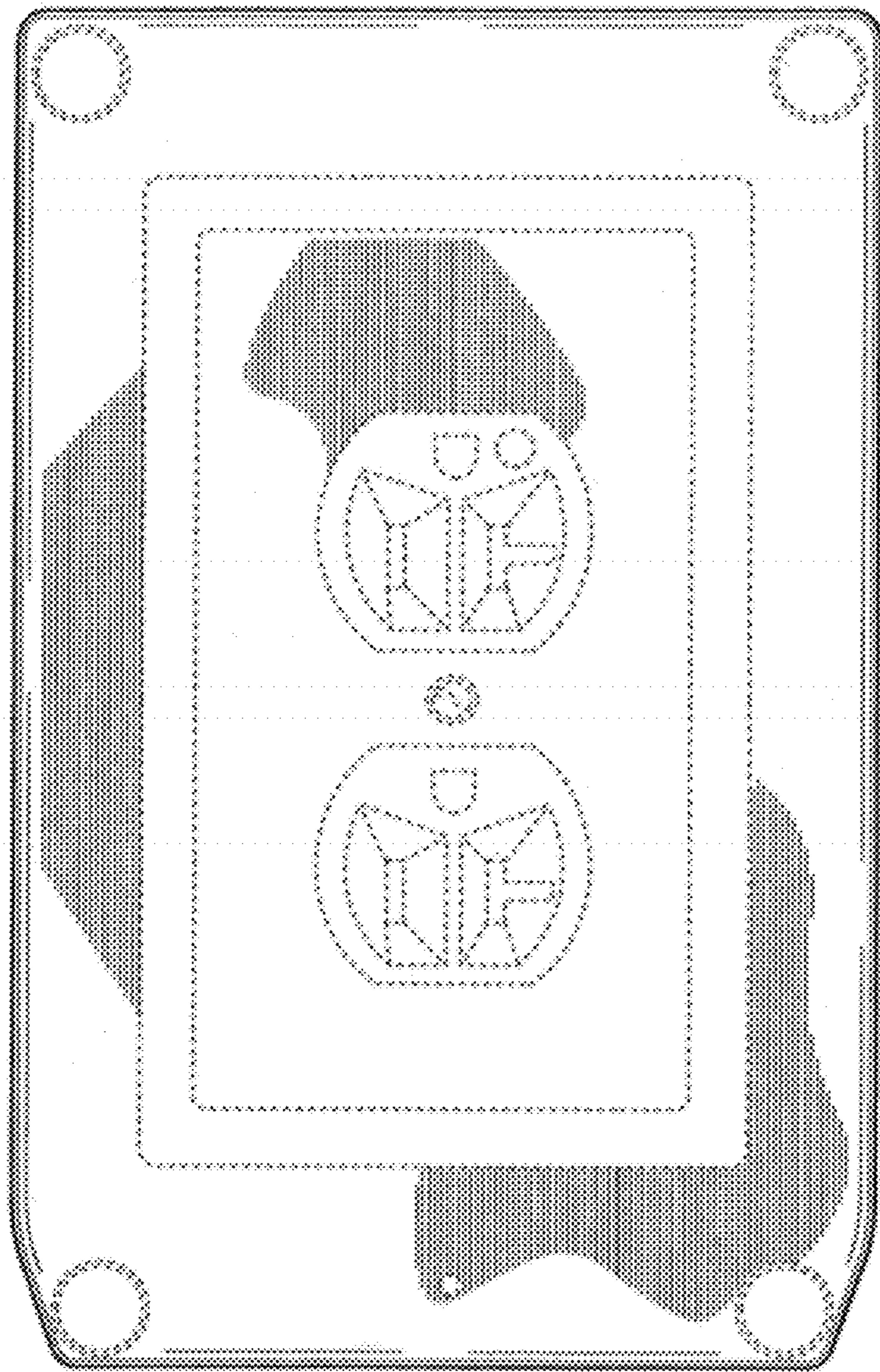

FIG. 2

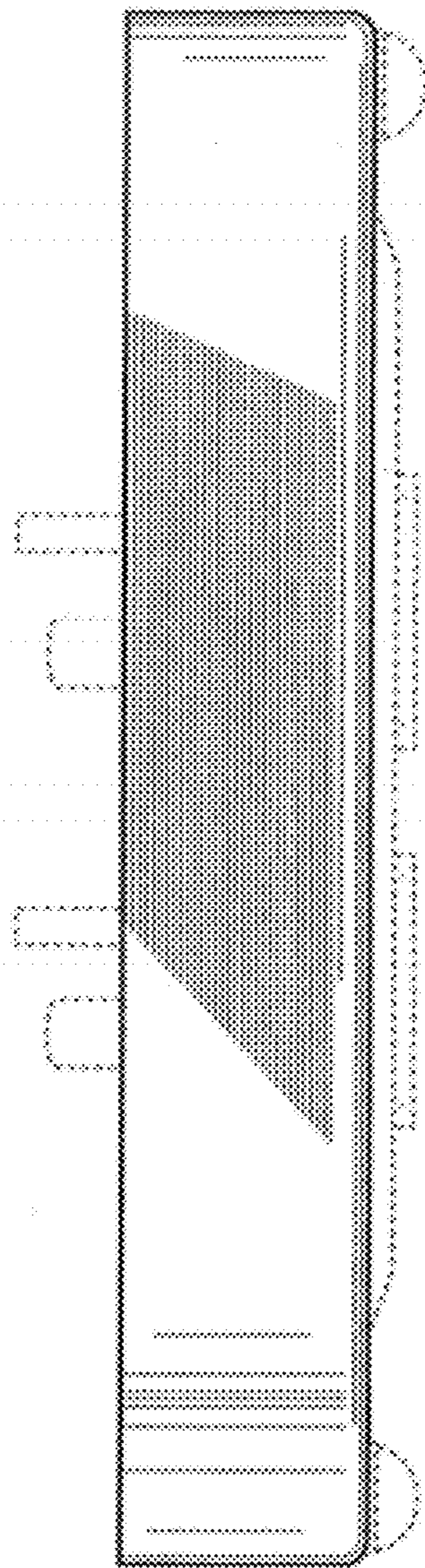

FIG. 3

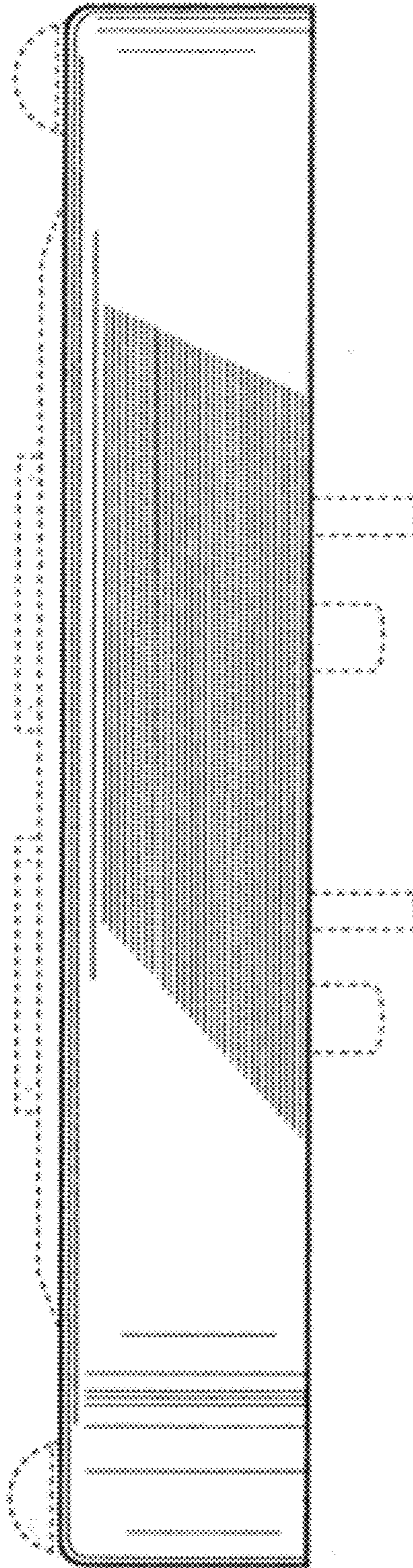

FIG. 4

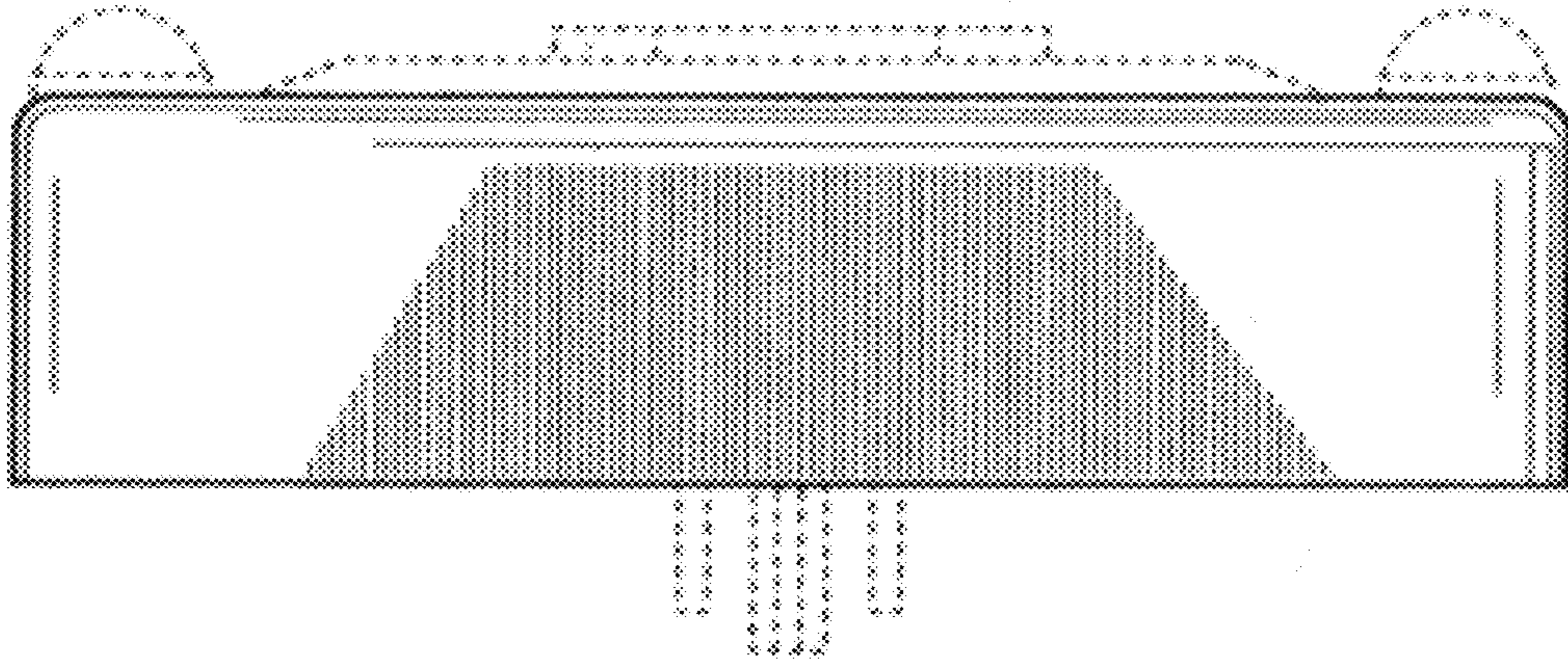

FIG. 5

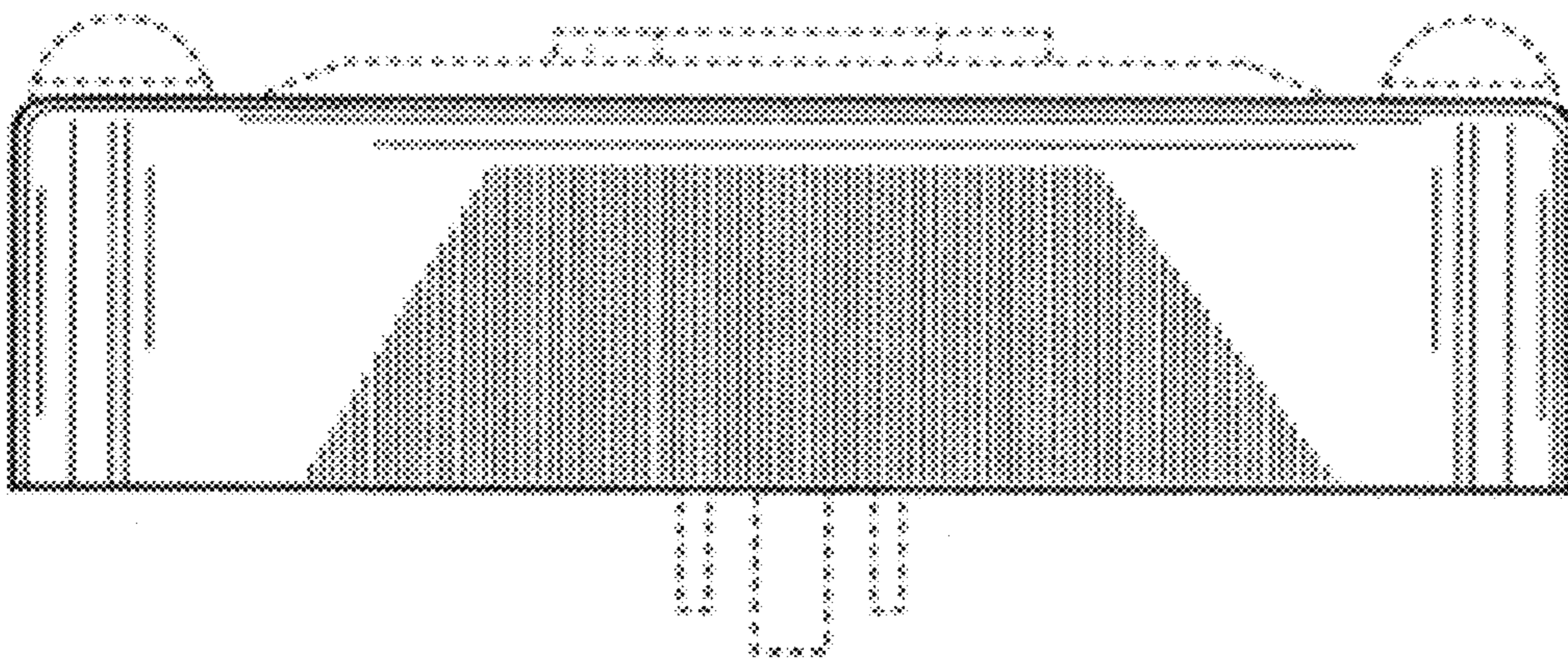

FIG. 6

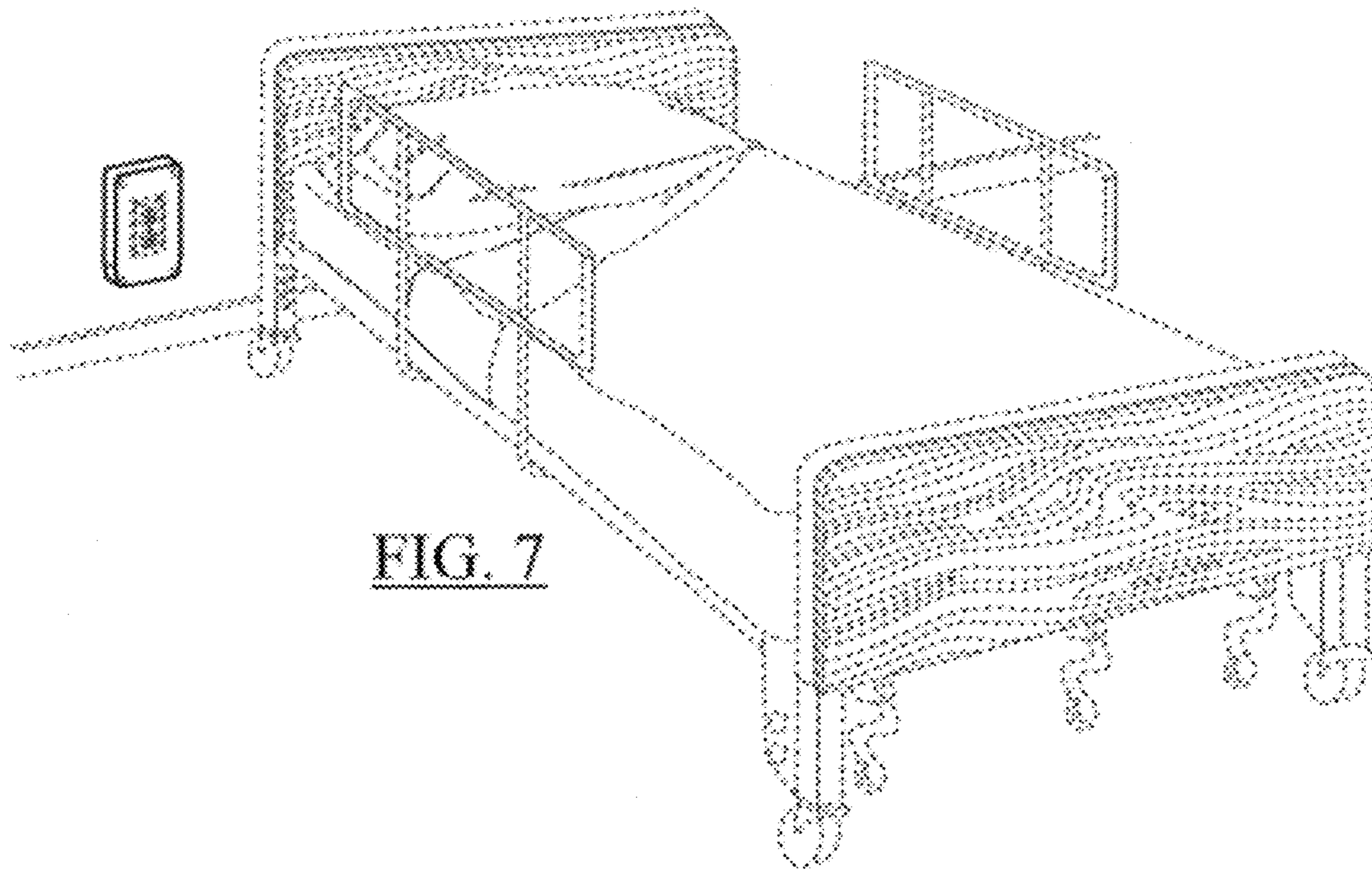

FIG. 7