

US00D666565S

(12) **United States Design Patent**
Kumano et al.

(10) **Patent No.:** **US D666,565 S**
(45) **Date of Patent:** **** Sep. 4, 2012**

(54) **TELEVISION RECEIVER**

(75) Inventors: **Daigaku Kumano**, Tokyo (JP); **Hiroaki Yokota**, Tokyo (JP); **Kenji Katsumata**, Tokyo (JP); **Yusuke Otani**, Tokyo (JP); **Koji Shindo**, Tokyo (JP)

(73) Assignee: **Sony Corporation**, Tokyo (JP)

(**) Term: **14 Years**

(21) Appl. No.: **29/300,719**

(22) Filed: **Apr. 30, 2008**

(30) **Foreign Application Priority Data**

- Nov. 2, 2007 (JP) D2007-030479
- Nov. 2, 2007 (JP) D2007-030480
- Nov. 2, 2007 (JP) D2007-030481
- Nov. 2, 2007 (JP) D2007-030482
- Dec. 26, 2007 (JP) D2007-035618
- Dec. 26, 2007 (JP) D2007-035619
- Dec. 26, 2007 (JP) D2007-035620
- Dec. 26, 2007 (JP) D2007-035621
- Dec. 28, 2007 (JP) D2007-036207
- Dec. 28, 2007 (JP) D2007-036209

(51) **LOC (9) Cl.** **14-03**

(52) **U.S. Cl.** **D14/126**

(58) **Field of Classification Search** D14/125-134, D14/239, 371, 136, 374-377, 440, 450, 448, D14/336, 342; 312/7.2; 348/836, 838, 180, 348/184, 325, 739; 341/12; 248/917-924, 248/465; 345/104, 133, 156, 168, 87, 173; 720/605, 669, 600, 655; 369/99, 197; D21/329, D21/515, 577, 622, 333, 433, 448, 452, 450, D21/331; D6/477, 479, 300; 273/148 B; 446/484, 175, 356; D10/15, 26

See application file for complete search history.

(56) **References Cited**

U.S. PATENT DOCUMENTS

- D488,451 S 4/2004 Niitsu
- D541,765 S * 5/2007 Niitsu D14/126
- D546,300 S 7/2007 Yokota
- D547,279 S 7/2007 Yokota
- D568,843 S 5/2008 Fujiki
- D569,816 S 5/2008 Fujiki
- D570,805 S 6/2008 Fujii
- D571,319 S 6/2008 Fujiki
- D572,678 S 7/2008 Fujiki
- D574,340 S 8/2008 Yokota
- D595,248 S * 6/2009 Fujii et al. D14/126

FOREIGN PATENT DOCUMENTS

RU 64718 11/2007

OTHER PUBLICATIONS

Office Action (Russian Design Application No. 2008502210) issued on Jan. 13, 2009 (Russia).

* cited by examiner

Primary Examiner — Raphael Barkai

(74) *Attorney, Agent, or Firm* — Rader, Fishman & Grauer PLLC

(57) **CLAIM**

The ornamental design for a television receiver, as shown and described.

DESCRIPTION

FIG. 1 is a front elevational view of a first embodiment of a television receiver showing our new design;
 FIG. 2 is a rear elevational view thereof;
 FIG. 3 is a partially enlarged view thereof taken along lines 3-3 and 3'-3' of FIG. 1;
 FIG. 4 is a partially enlarged view thereof taken along lines 4-4 and 4'-4' of FIG. 1; and
 FIG. 5 is a partially enlarged view thereof taken along lines 5-5 and 5'-5' of FIG. 1.
 FIG. 6 is a front elevational of a second embodiment of a television receiver showing our new design;
 FIG. 7 is a rear elevational view thereof;

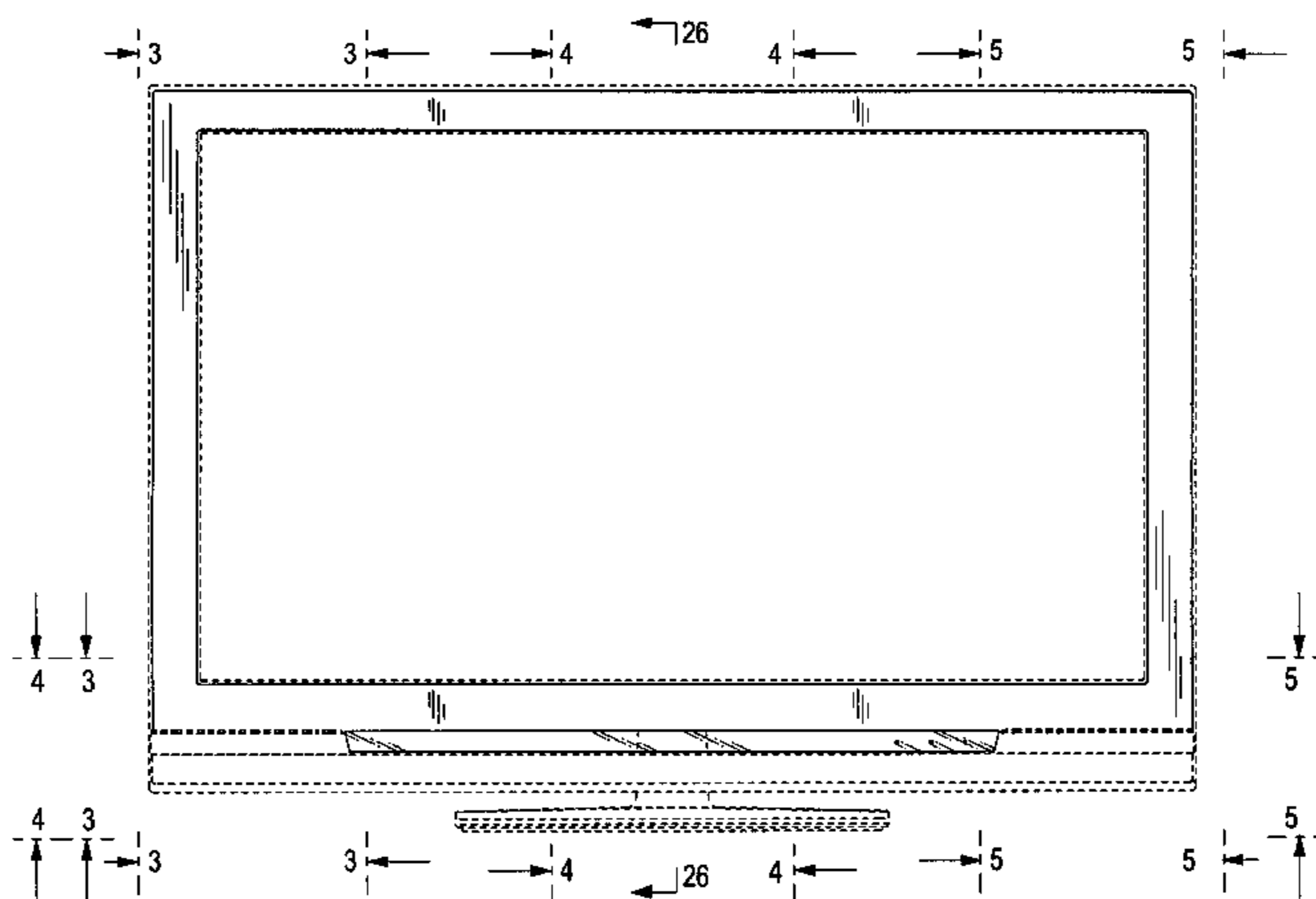

FIG. 8 is a partially enlarged view thereof taken along lines 8-8 and 8'-8' of FIG. 6;

FIG. 9 is a partially enlarged view thereof taken along lines 9-9 and 9'-9' of FIG. 6; and

FIG. 10 is a partially enlarged view thereof taken along lines 10-10 and 10'-10' of FIG. 6.

FIG. 11 is a front elevational view of a third embodiment of a television receiver showing our new design;

FIG. 12 is a rear elevational view thereof;

FIG. 13 is a partially enlarged view thereof taken along lines 13-13 and 13'-13' of FIG. 11;

FIG. 14 is a partially enlarged view thereof taken along lines 14-14 and 14'-14' of FIG. 11; and

FIG. 15 is a partially enlarged view thereof taken along lines 15-15 and 15'-15' of FIG. 11.

FIG. 16 is a front elevational view of a fourth embodiment of a television receiver showing our new design;

FIG. 17 is a rear elevational view thereof;

FIG. 18 is a partially enlarged view thereof taken along lines 18-18 and 18'-18' of FIG. 16;

FIG. 19 is a partially enlarged view thereof taken along lines 19-19 and 19'-19' of FIG. 16; and

FIG. 20 is a partially enlarged view thereof taken along lines 20-20 and 20'-20' of FIG. 16.

FIG. 21 is a front elevational view of a fifth embodiment of a television receiver showing our new design;

FIG. 22 is a rear elevational view thereof;

FIG. 23 is a partially enlarged view thereof taken along lines 23-23 and 23'-23' of FIG. 21;

FIG. 24 is a partially enlarged view thereof taken along lines 24-24 and 24'-24' of FIG. 21; and

FIG. 25 is a partially enlarged view thereof taken along lines 25-25 and 25'-25' of FIG. 21.

FIG. 26 is a cross sectional view along the line 26-26 of FIG. 1.

FIG. 27 is a cross sectional view along the line 27-27 of FIG. 6.

FIG. 28 is a cross sectional view along the line 28-28 of FIG. 11.

FIG. 29 is a cross sectional view along the line 29-29 of FIG. 16; and,

FIG. 30 is a cross sectional view along the line 30-30 of FIG. 21.

Portions in broken lines are for illustrative purposes only and form no part of claimed design.

1 Claim, 30 Drawing Sheets

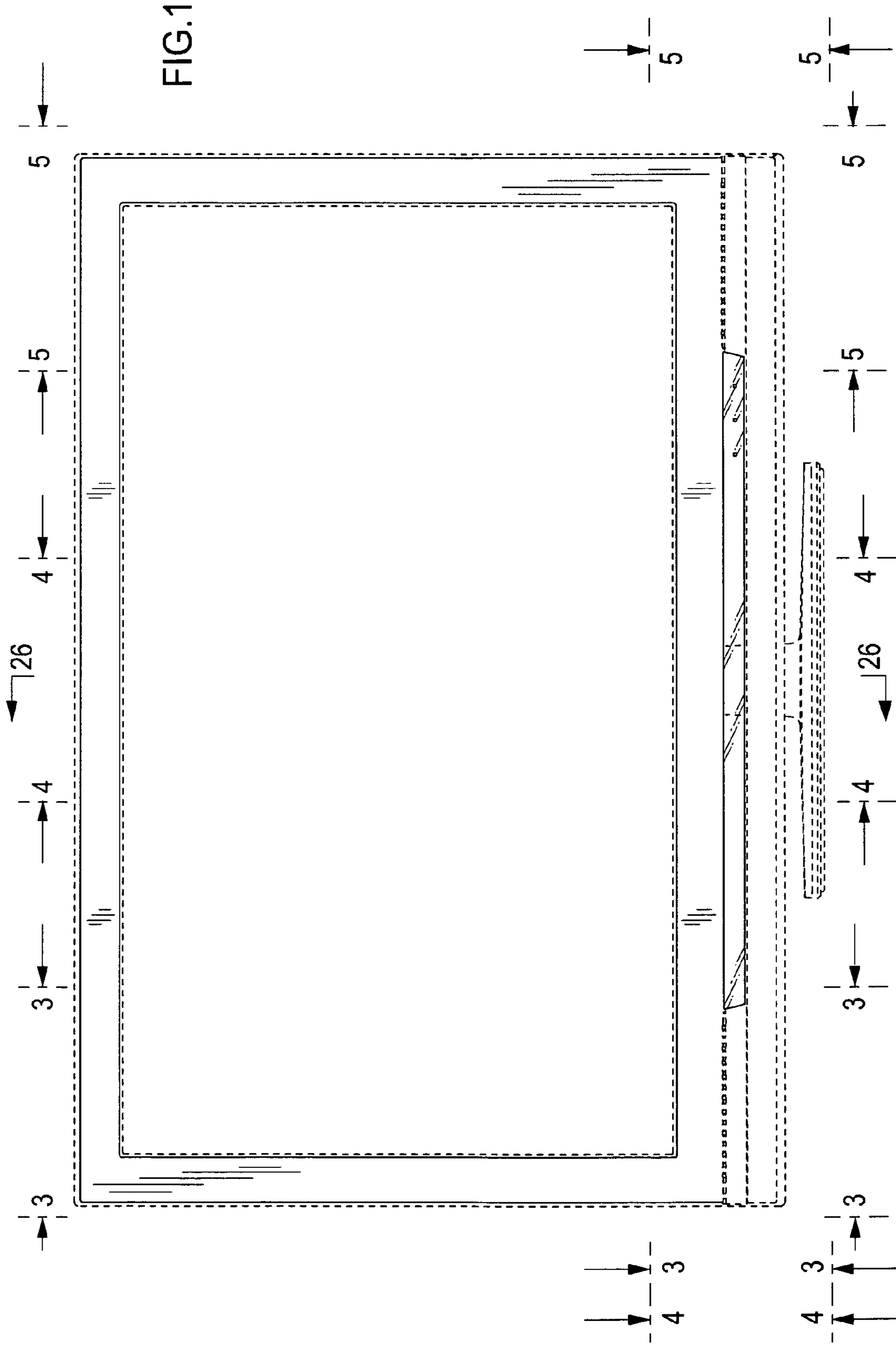

FIG.2

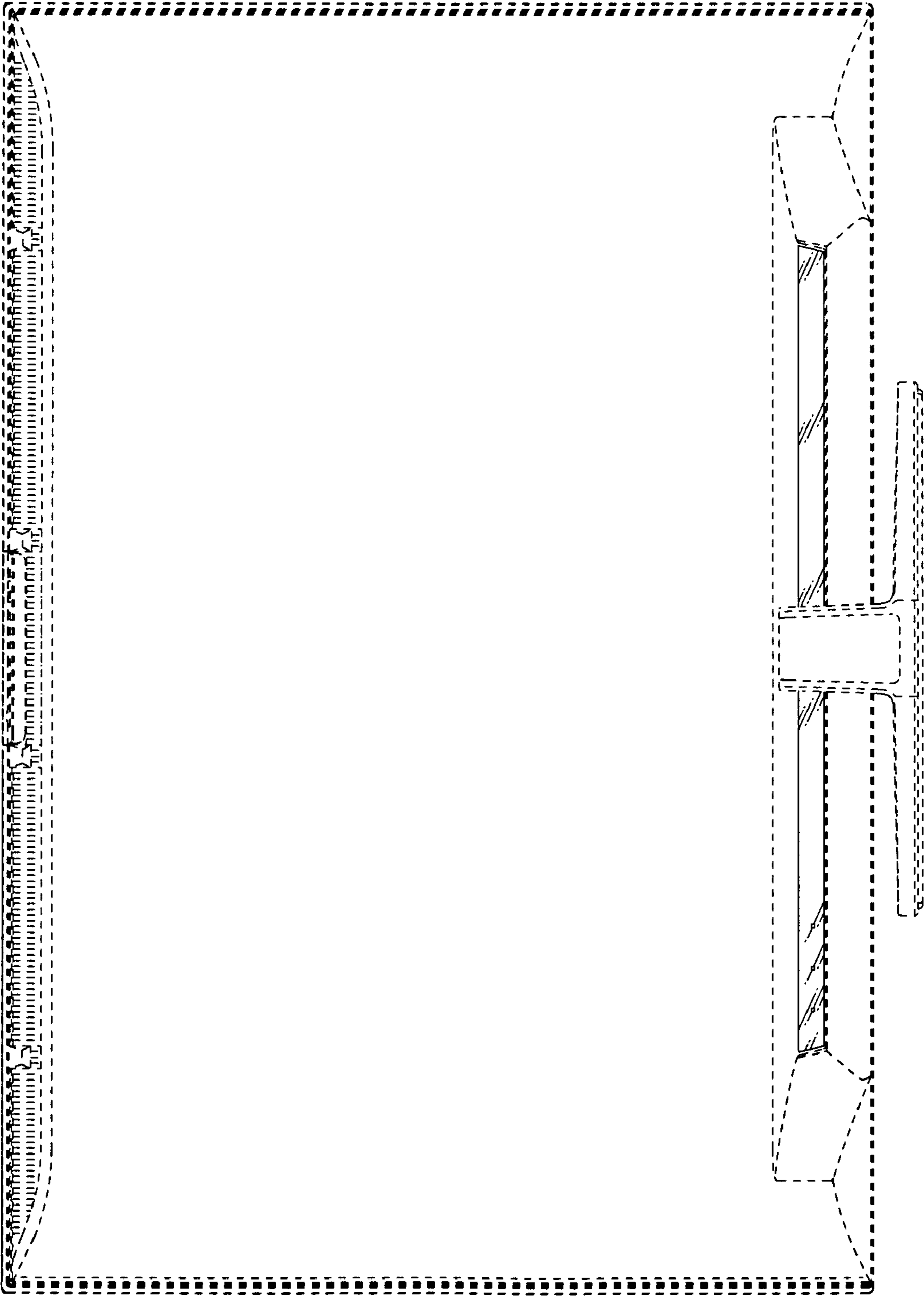

FIG.3

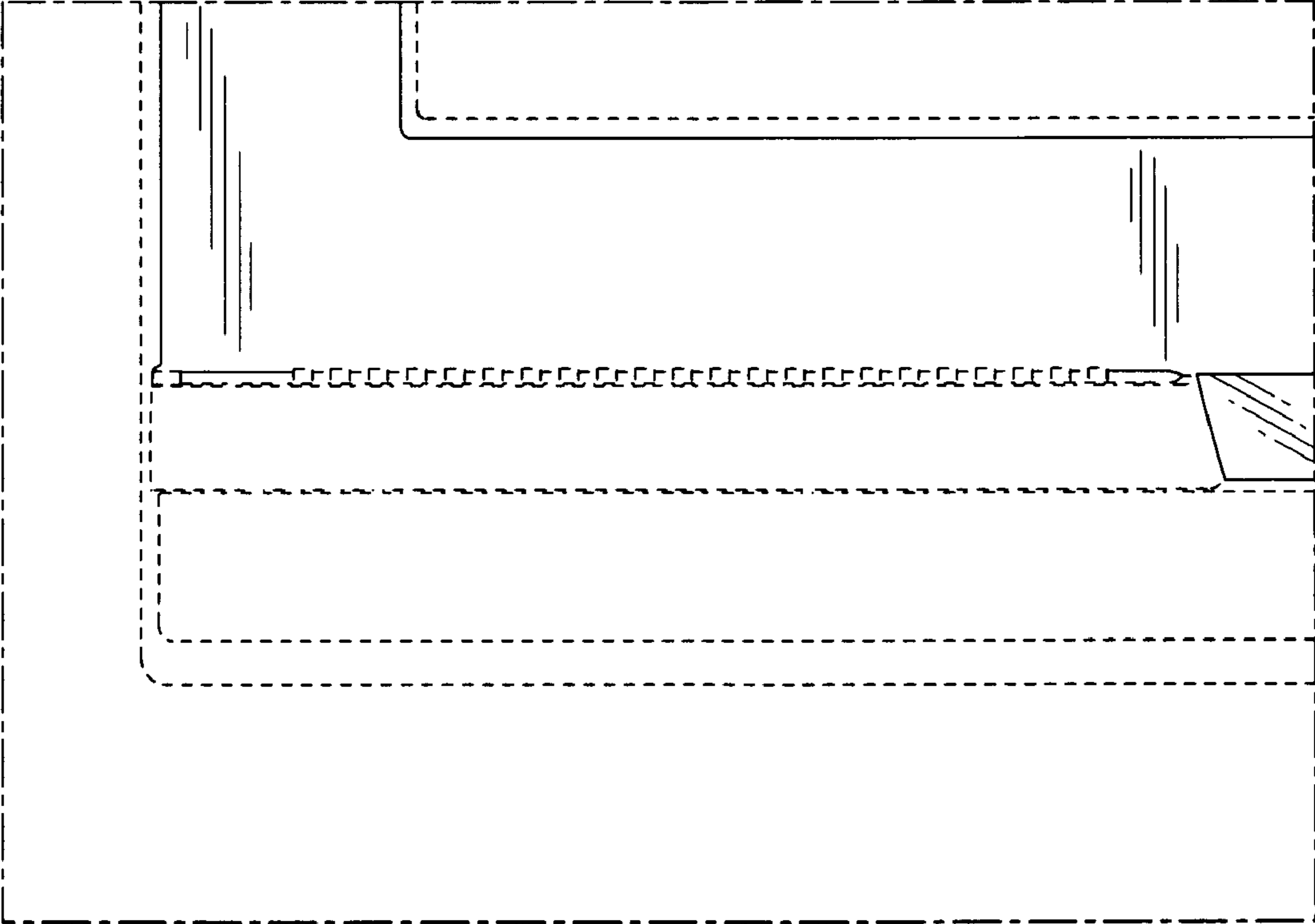

FIG.4

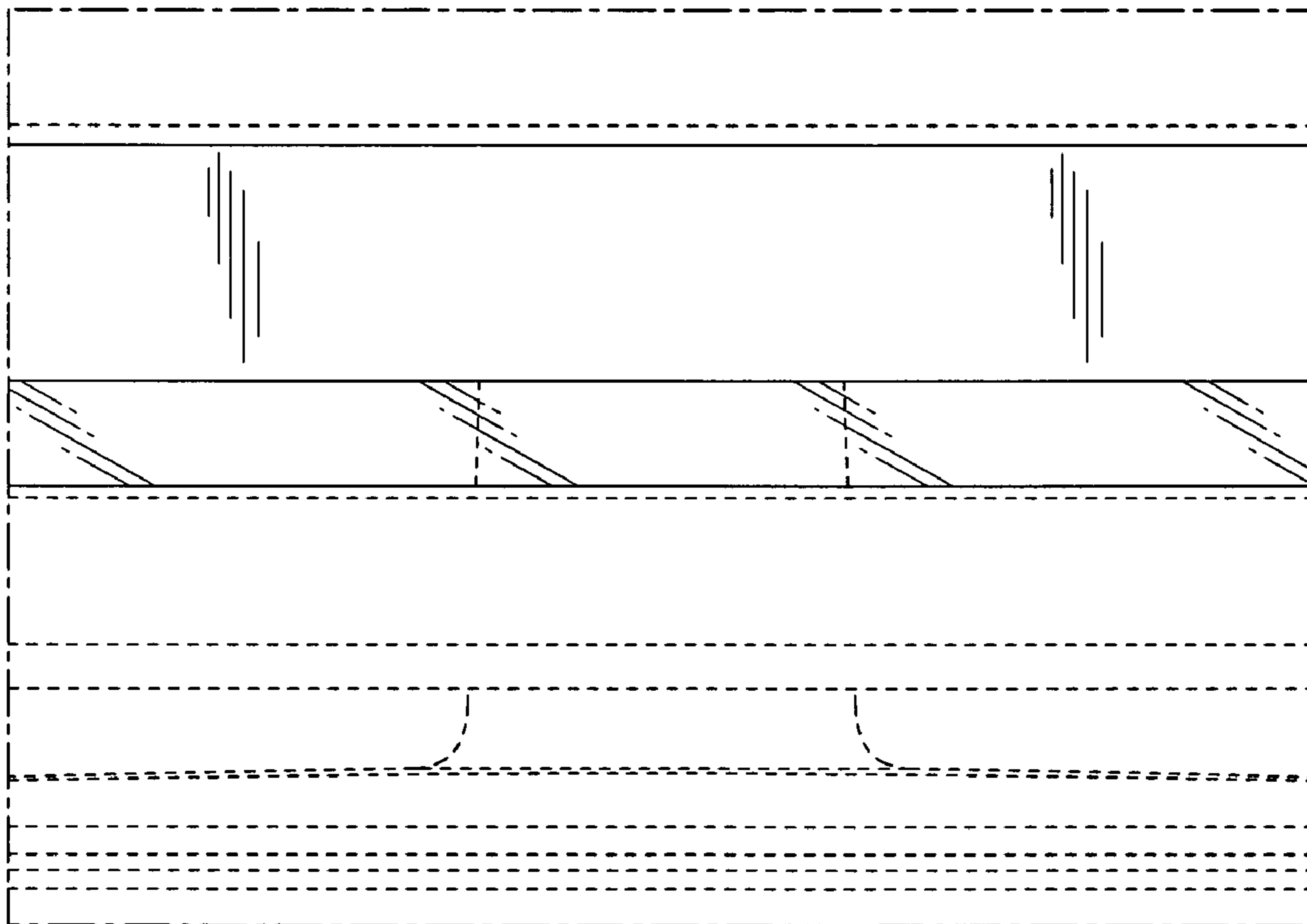
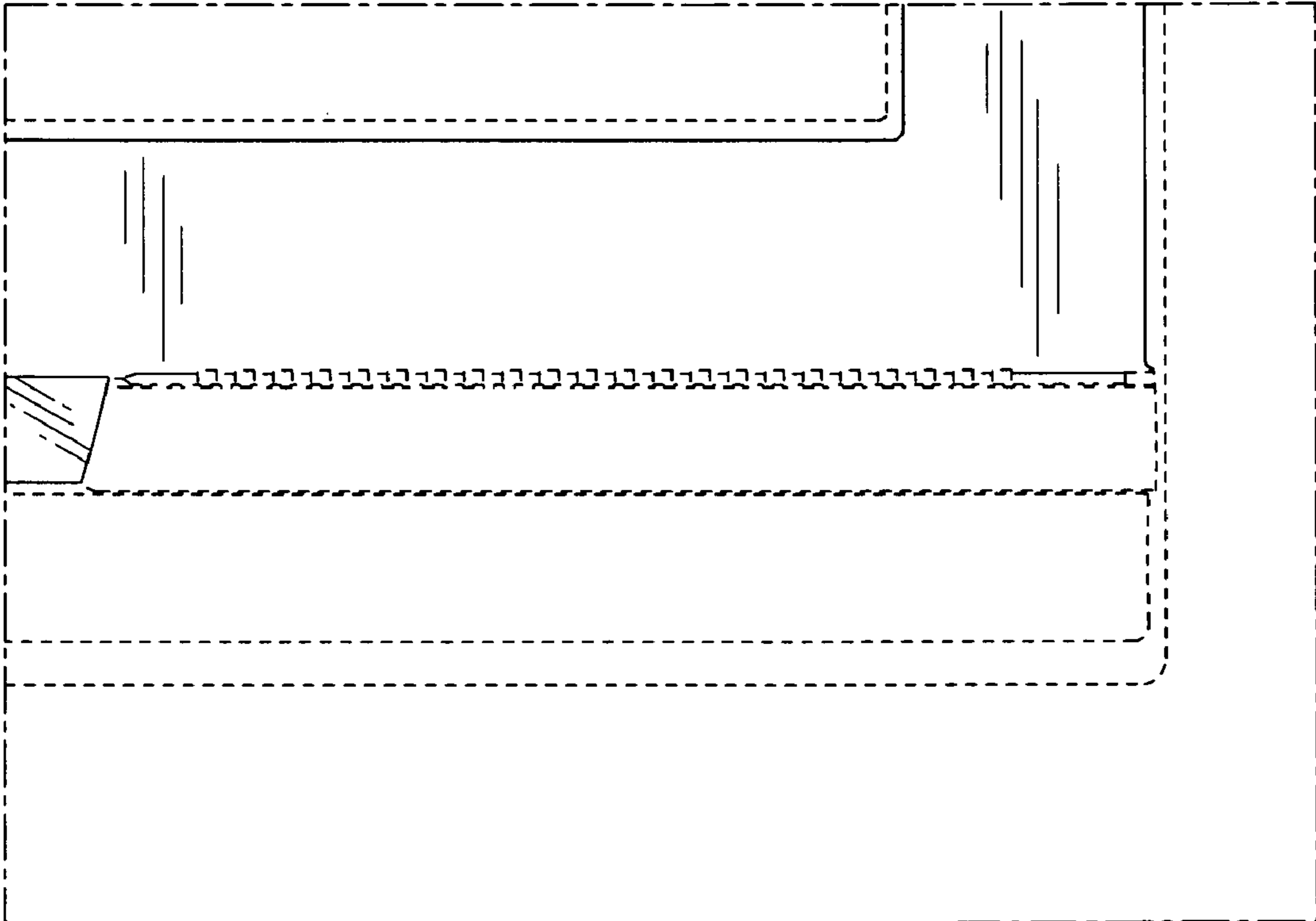

FIG.5



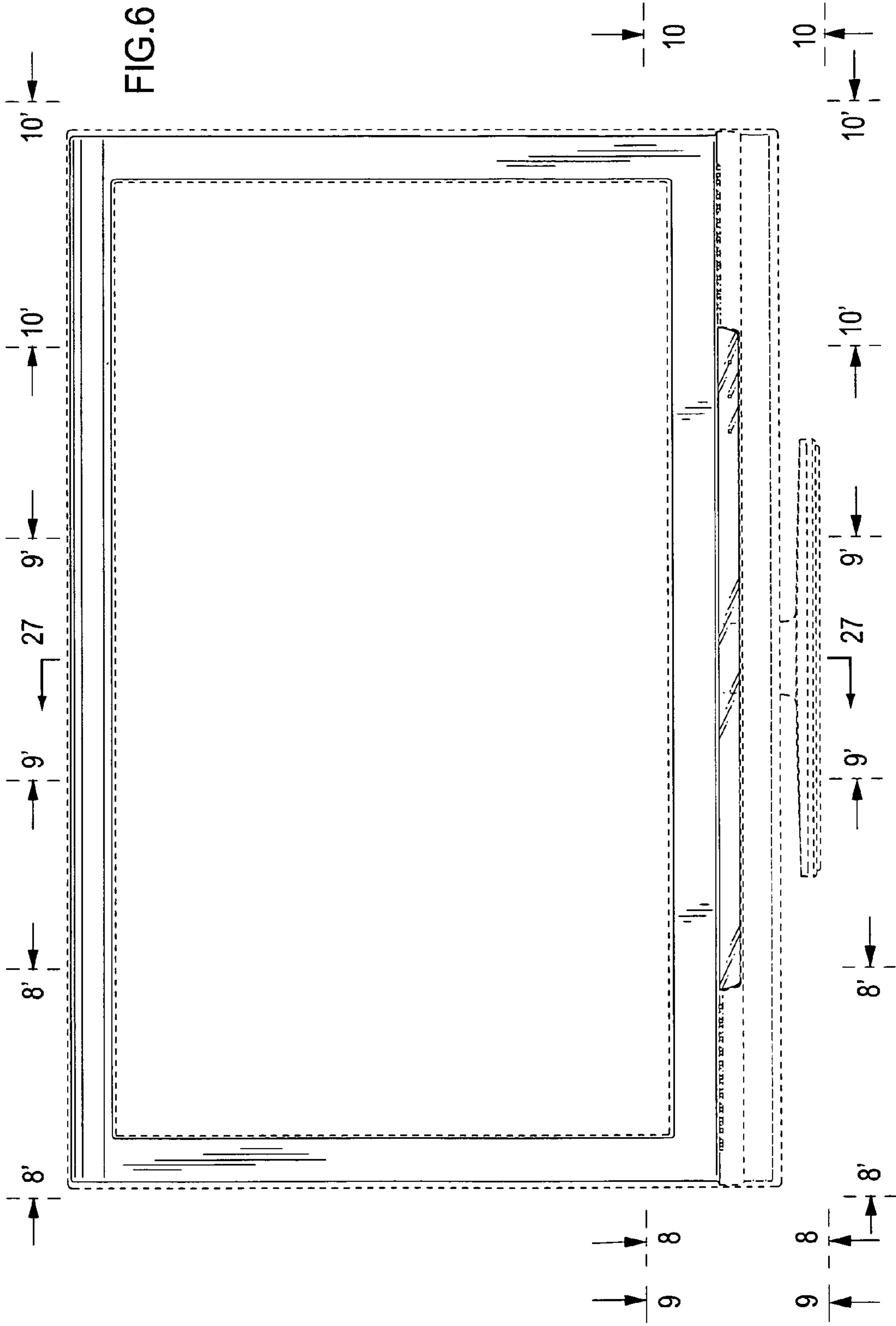

FIG. 7

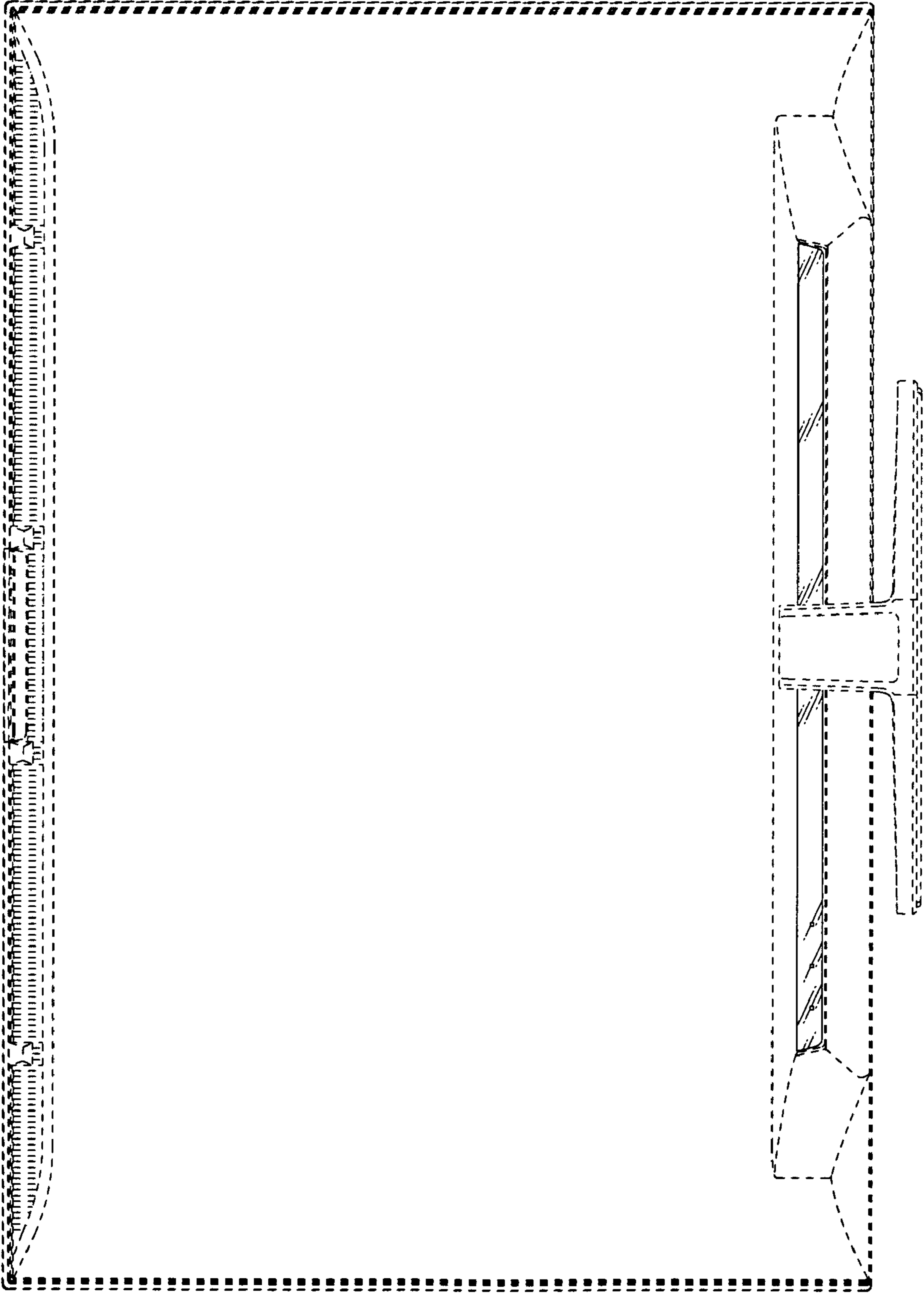

FIG.8

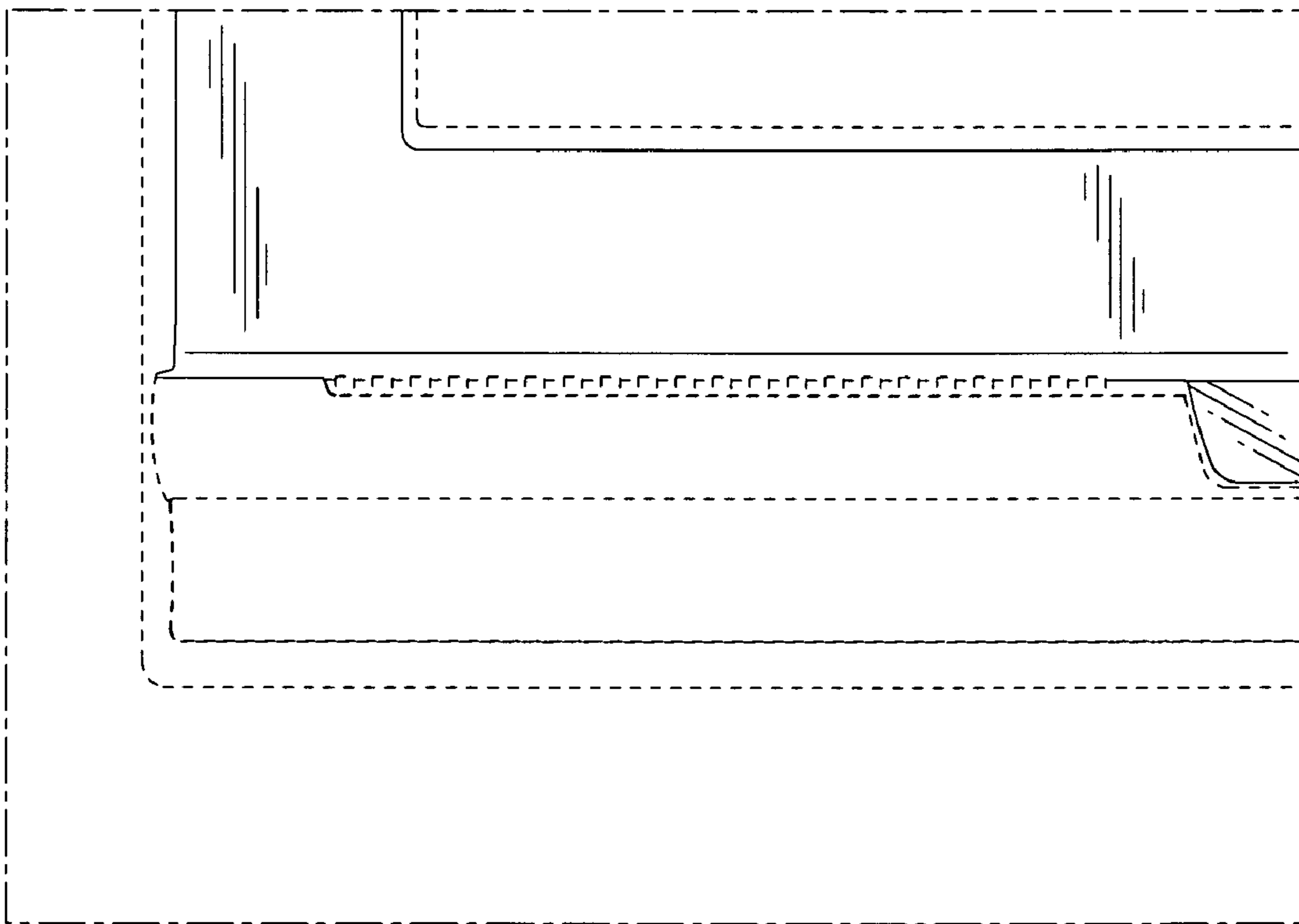
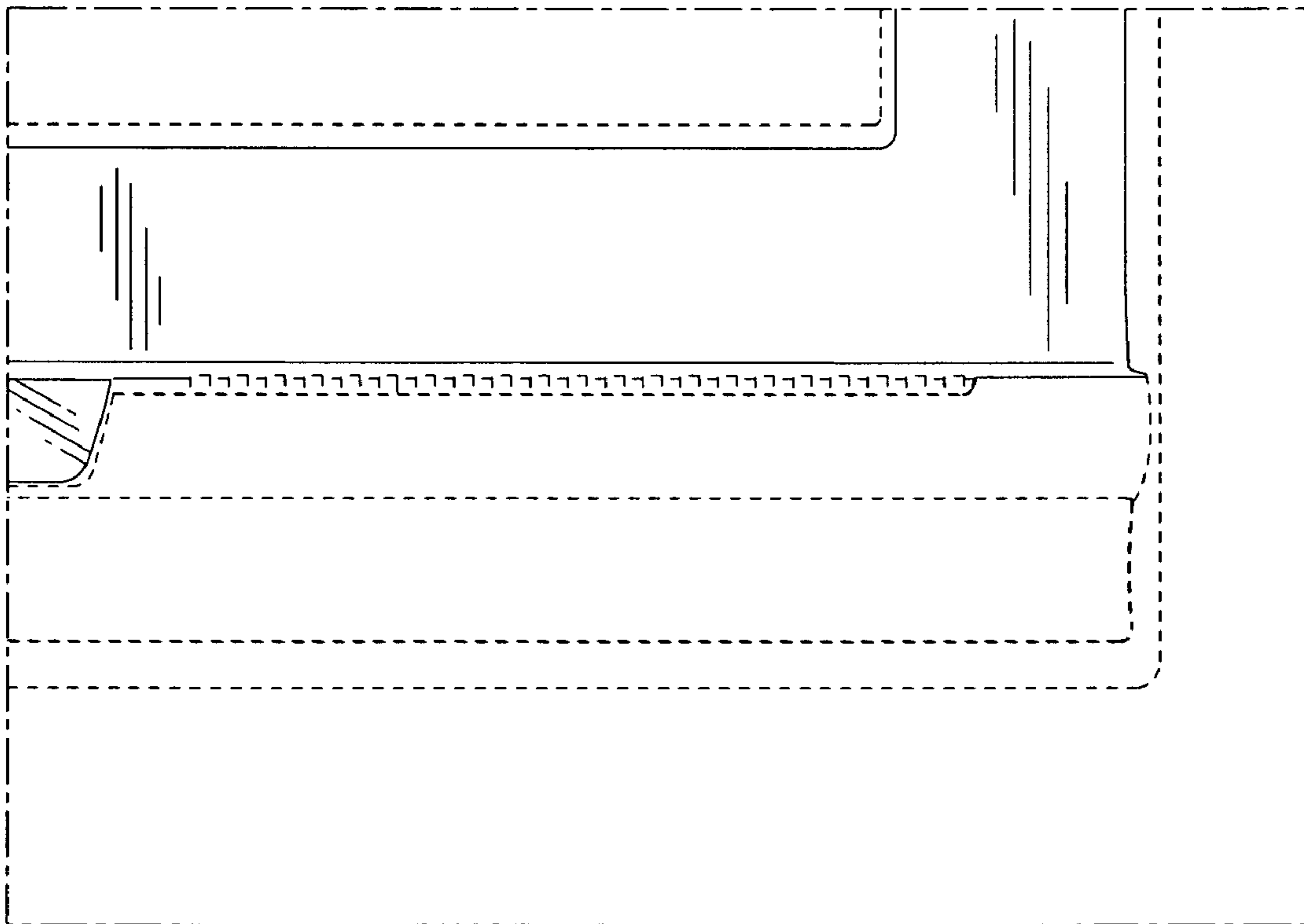

FIG.9



FIG.10



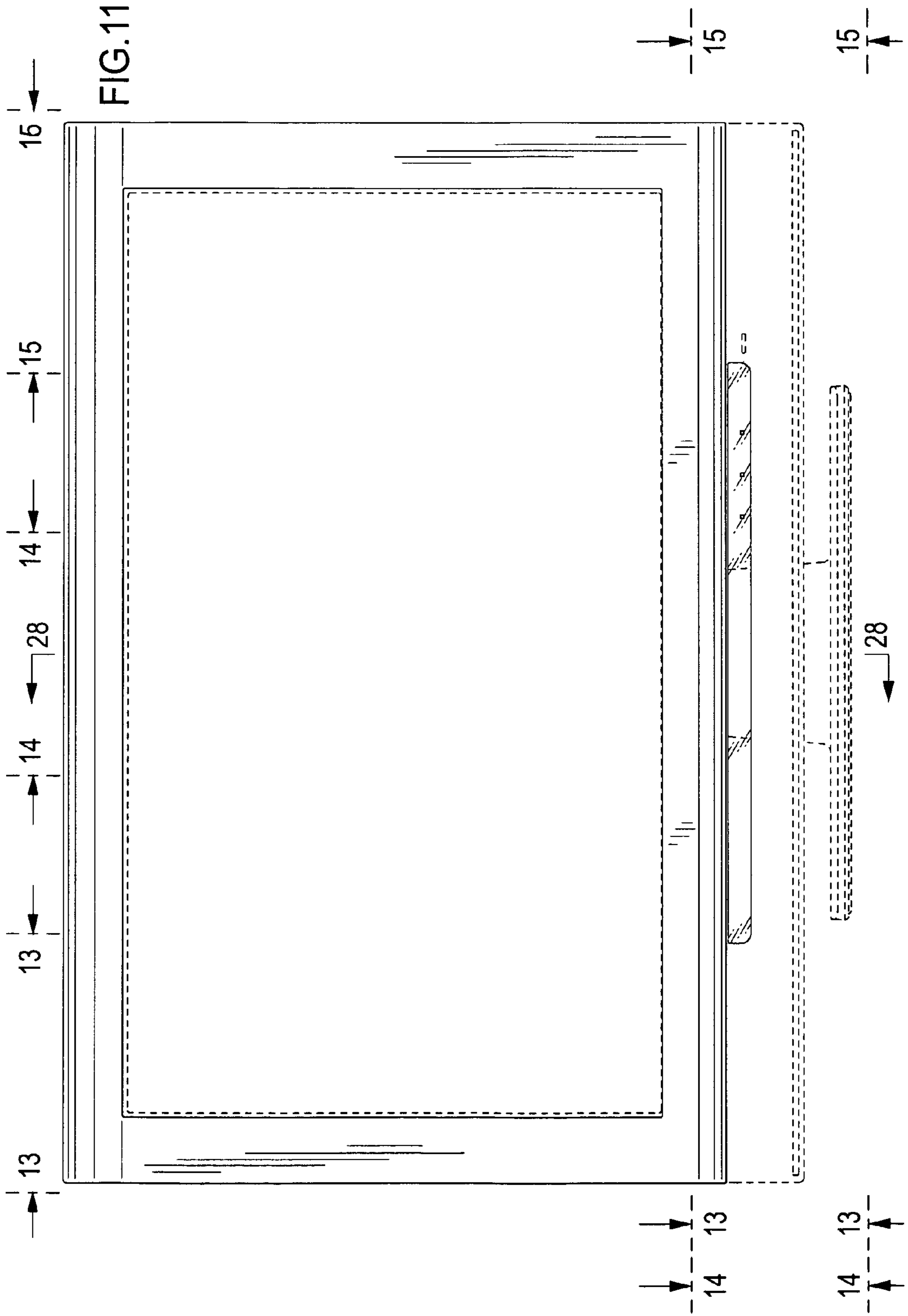

FIG. 12

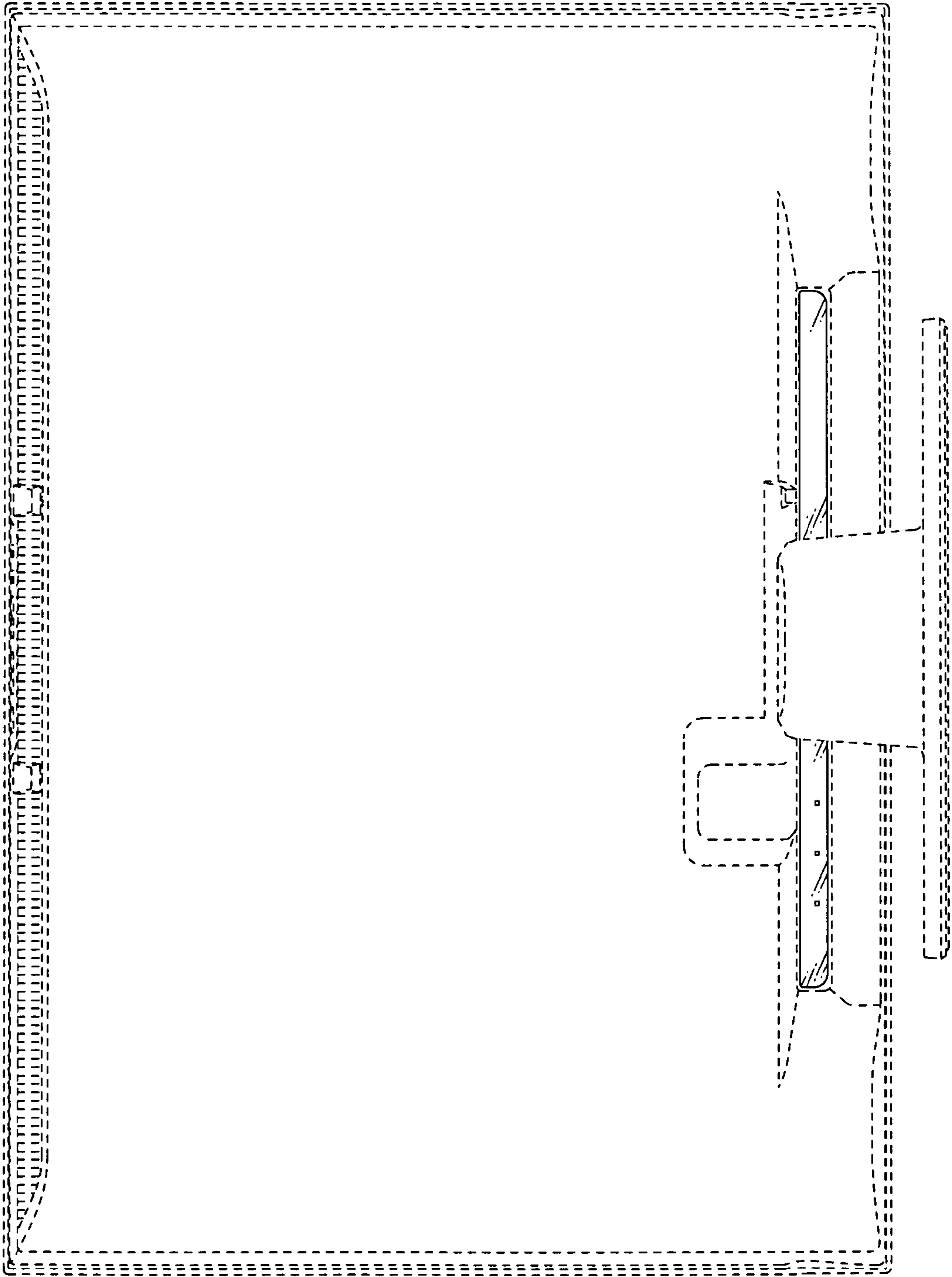

FIG.13

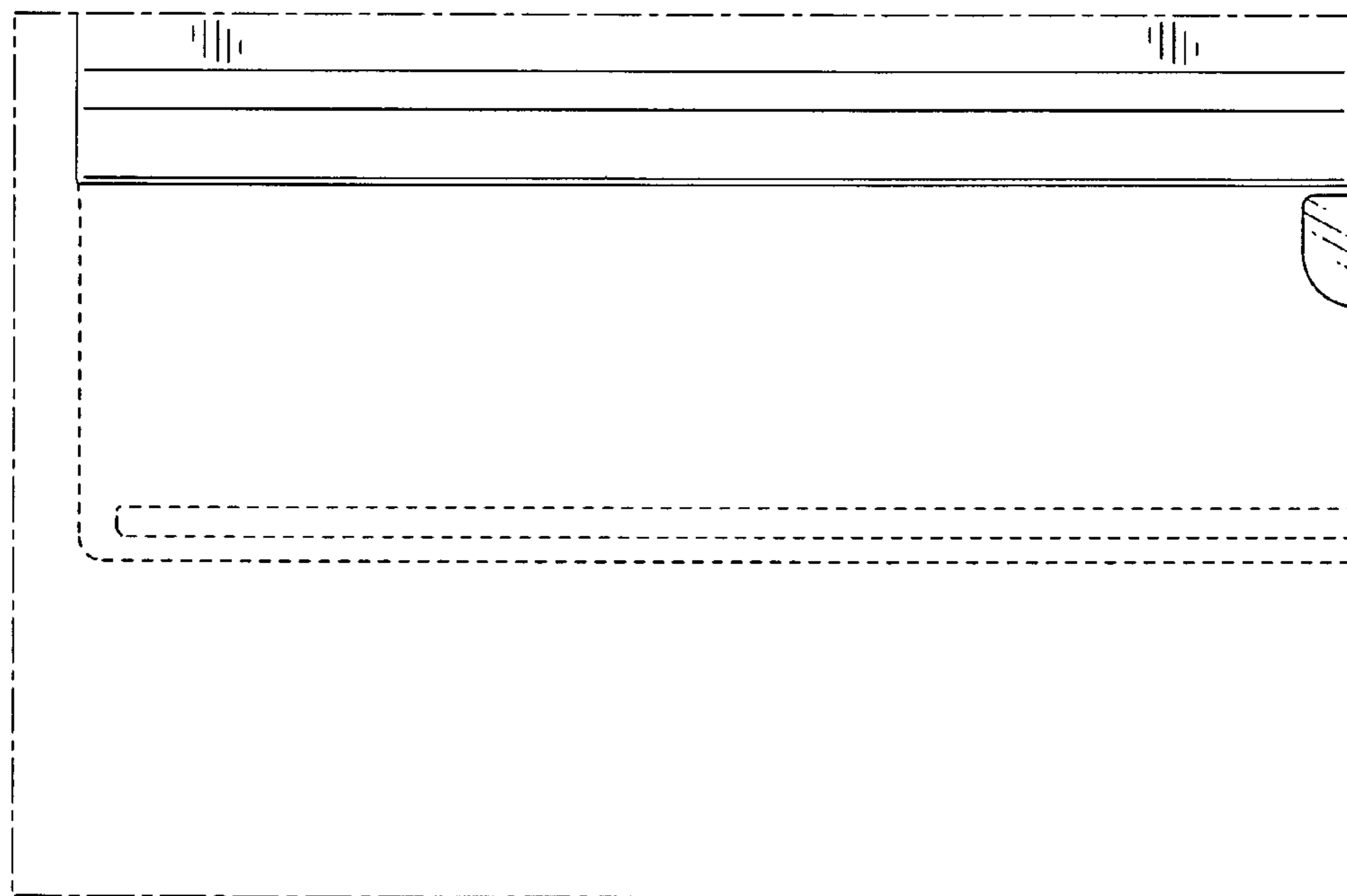

FIG.14

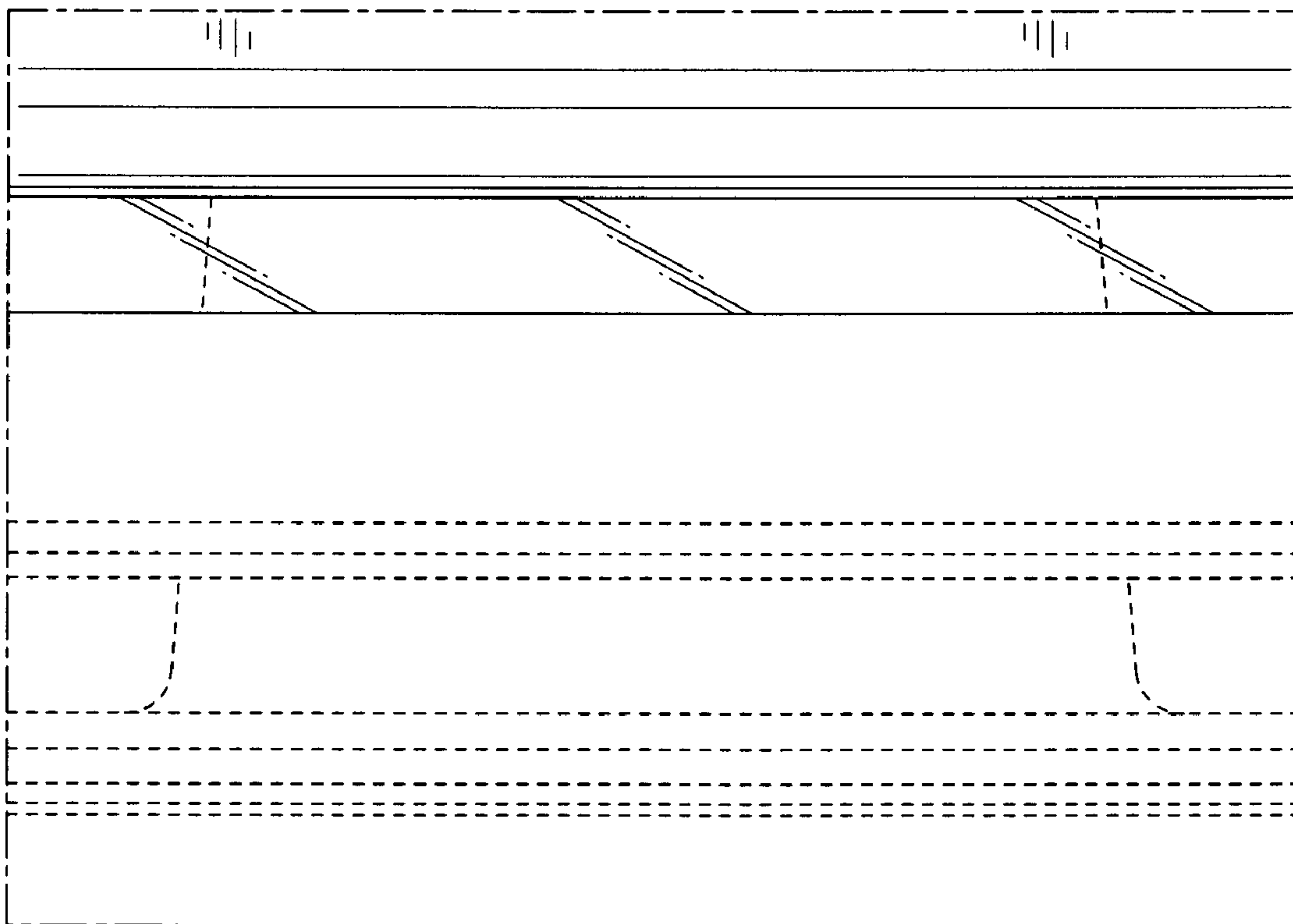
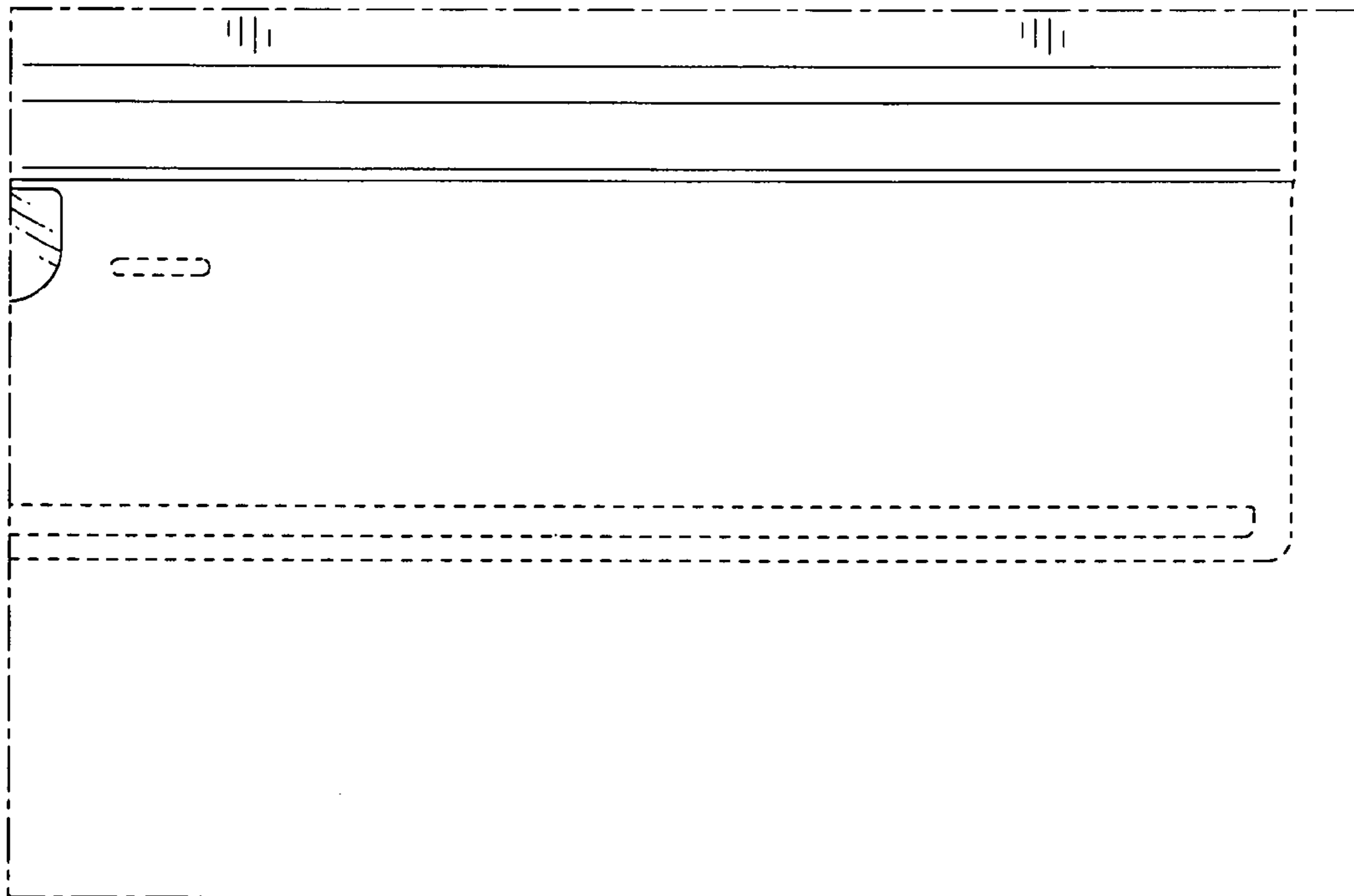

FIG.15



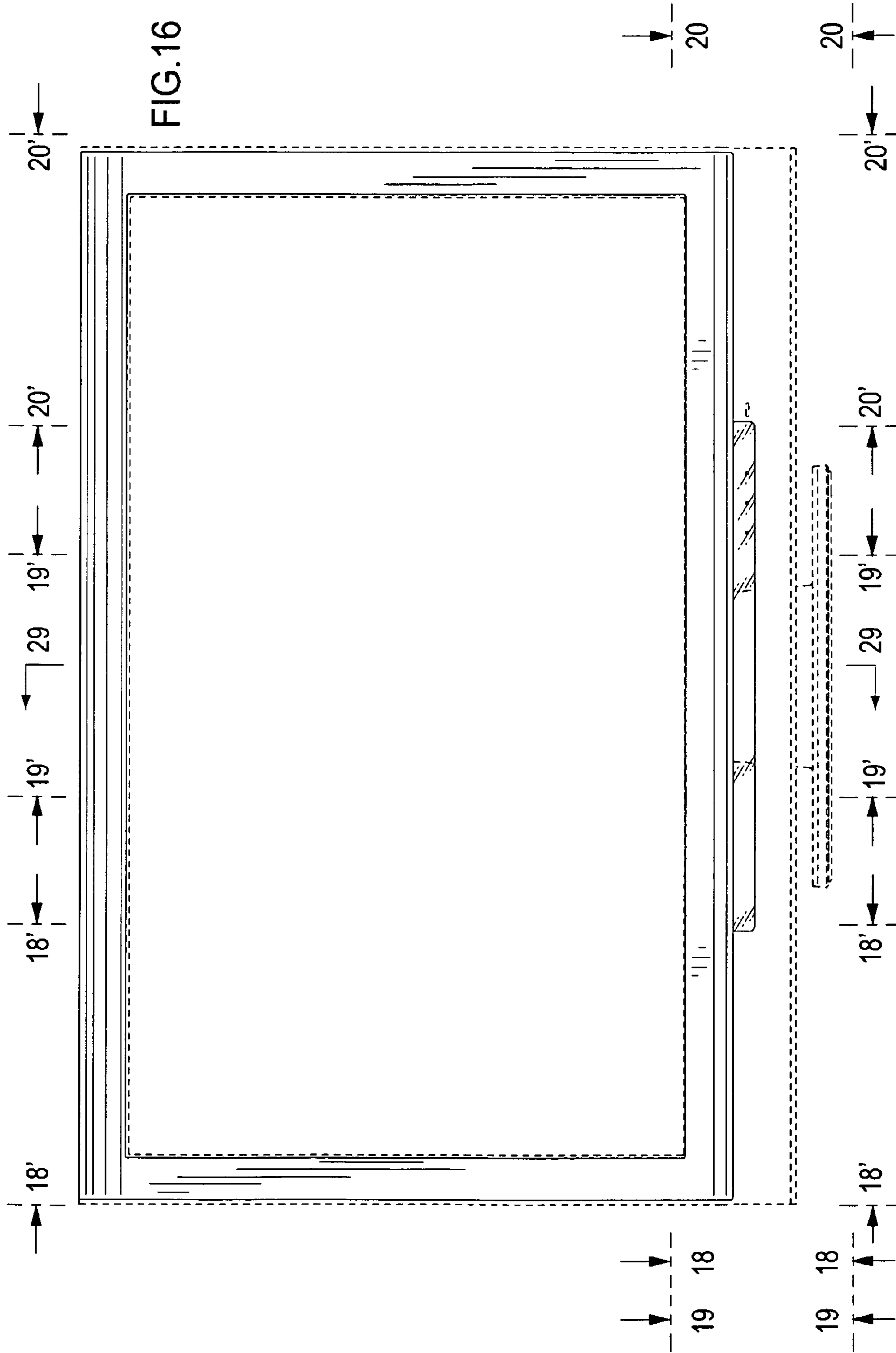

FIG.17

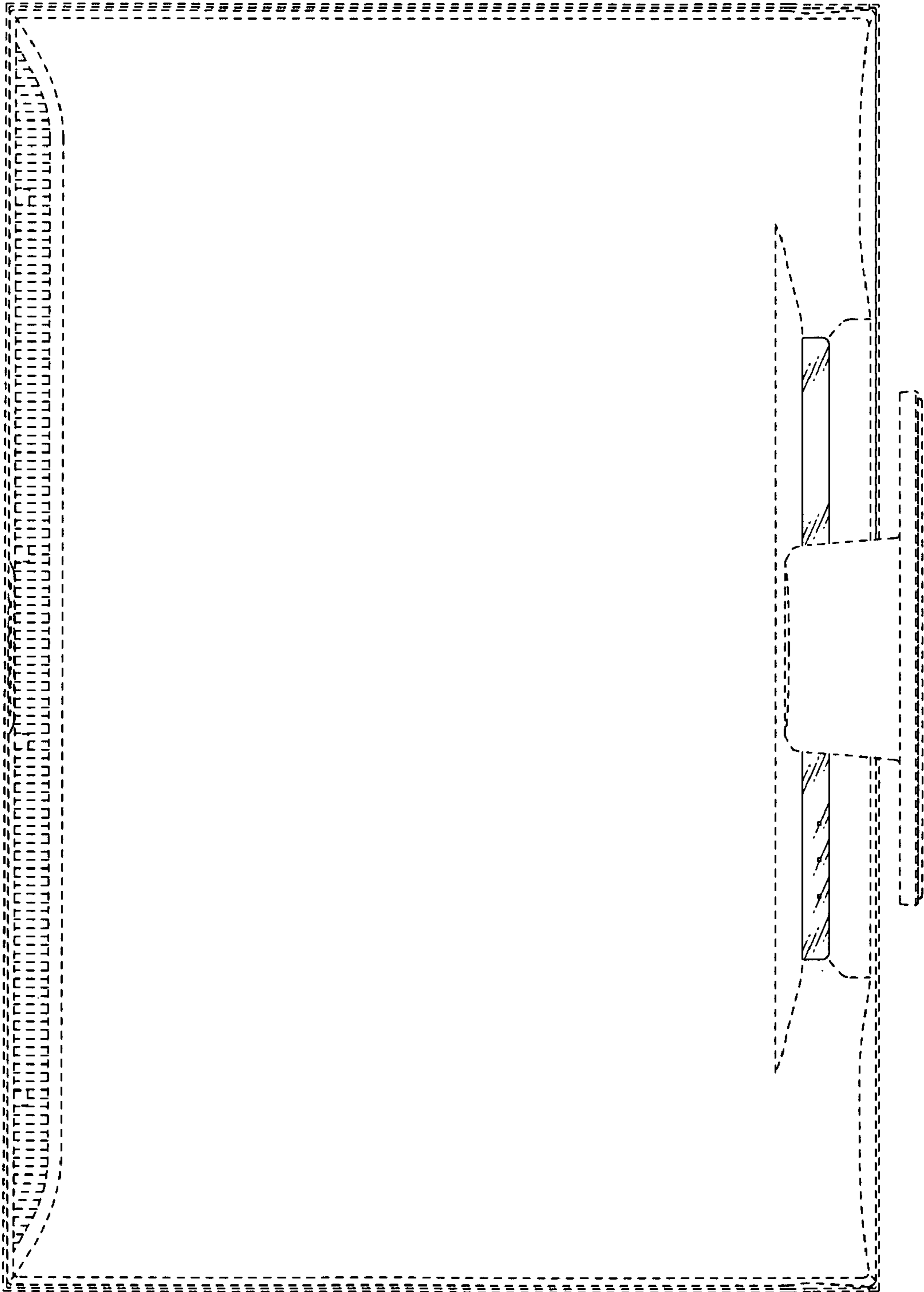

FIG.18

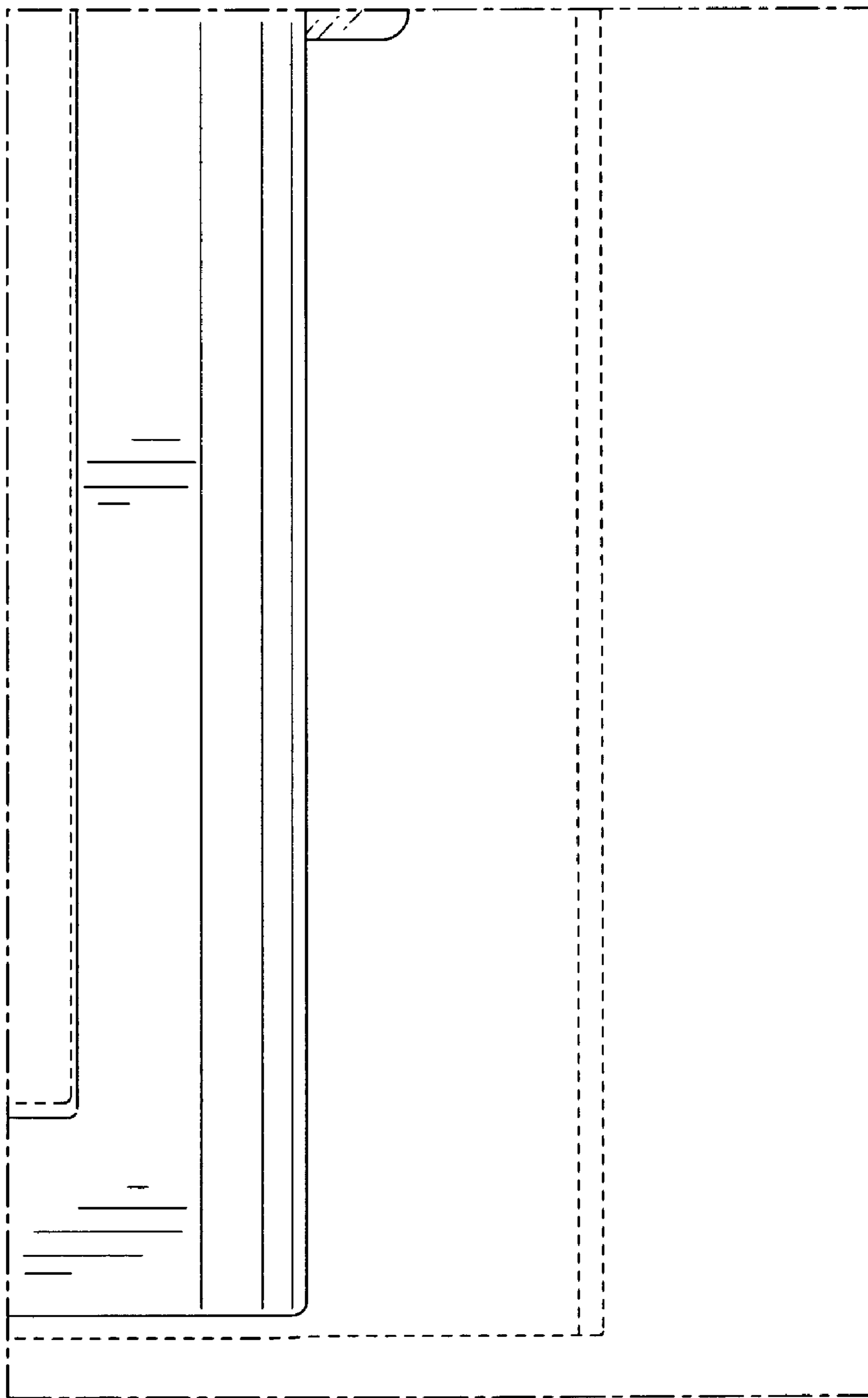

FIG. 19

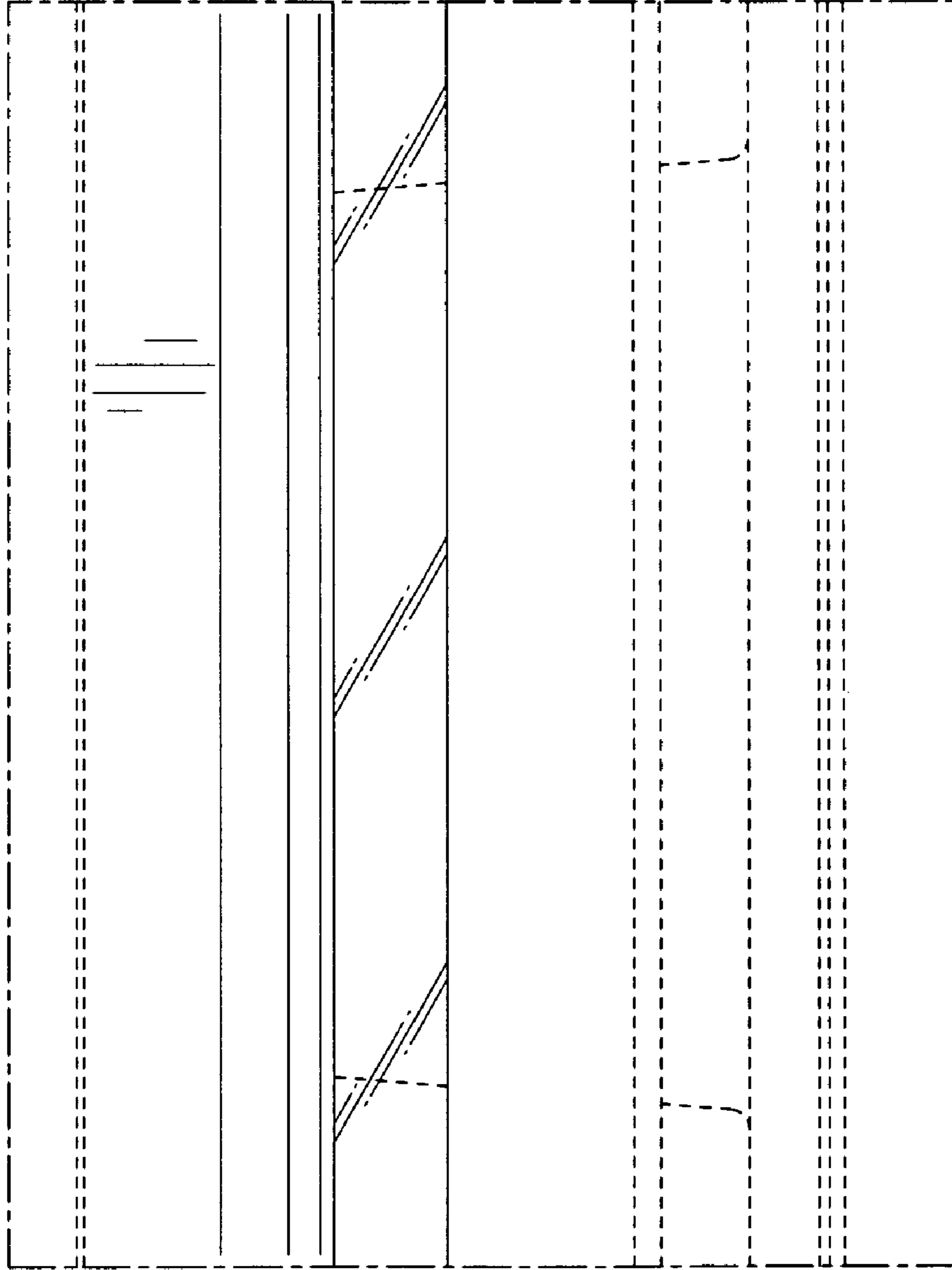
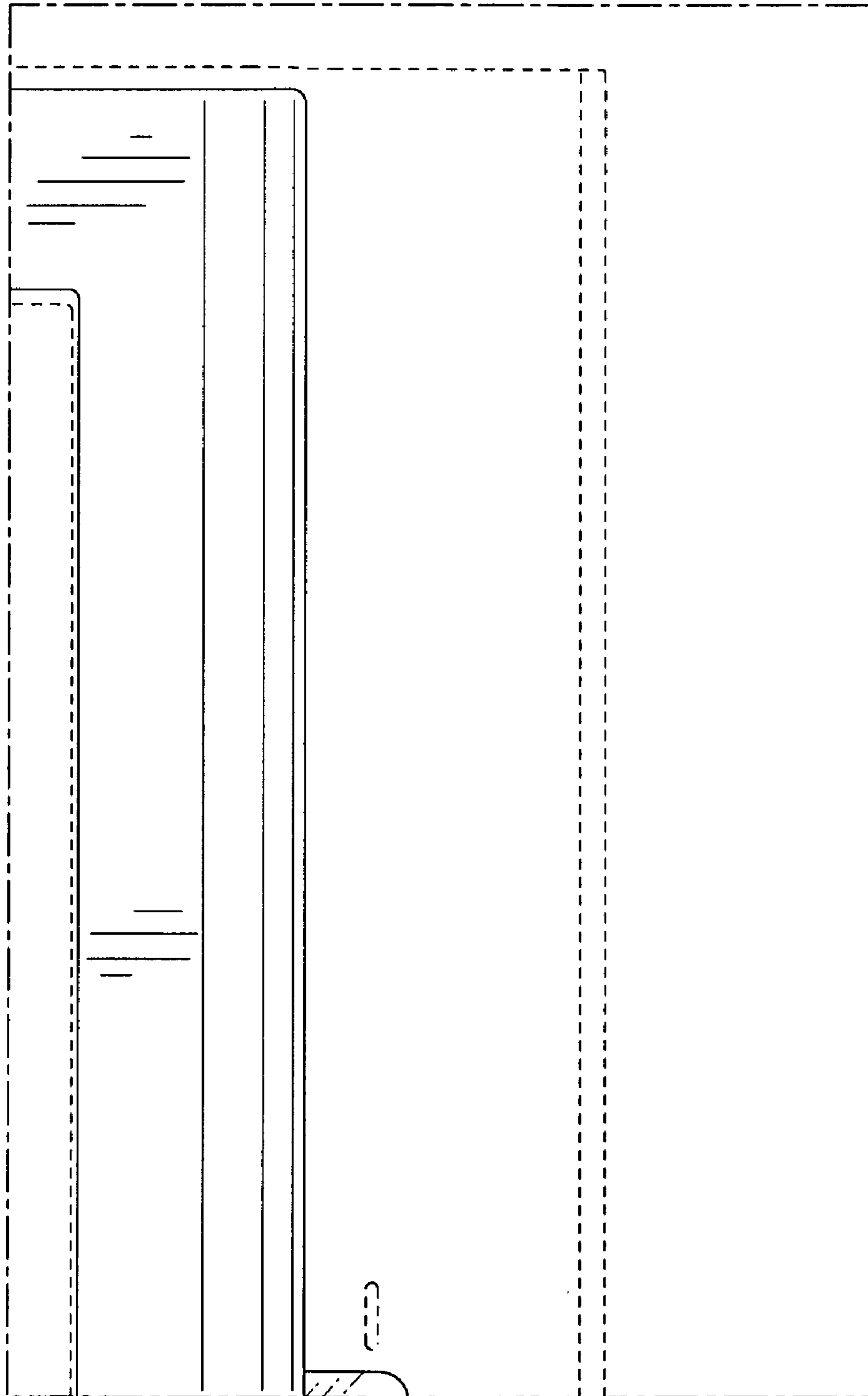

FIG. 20



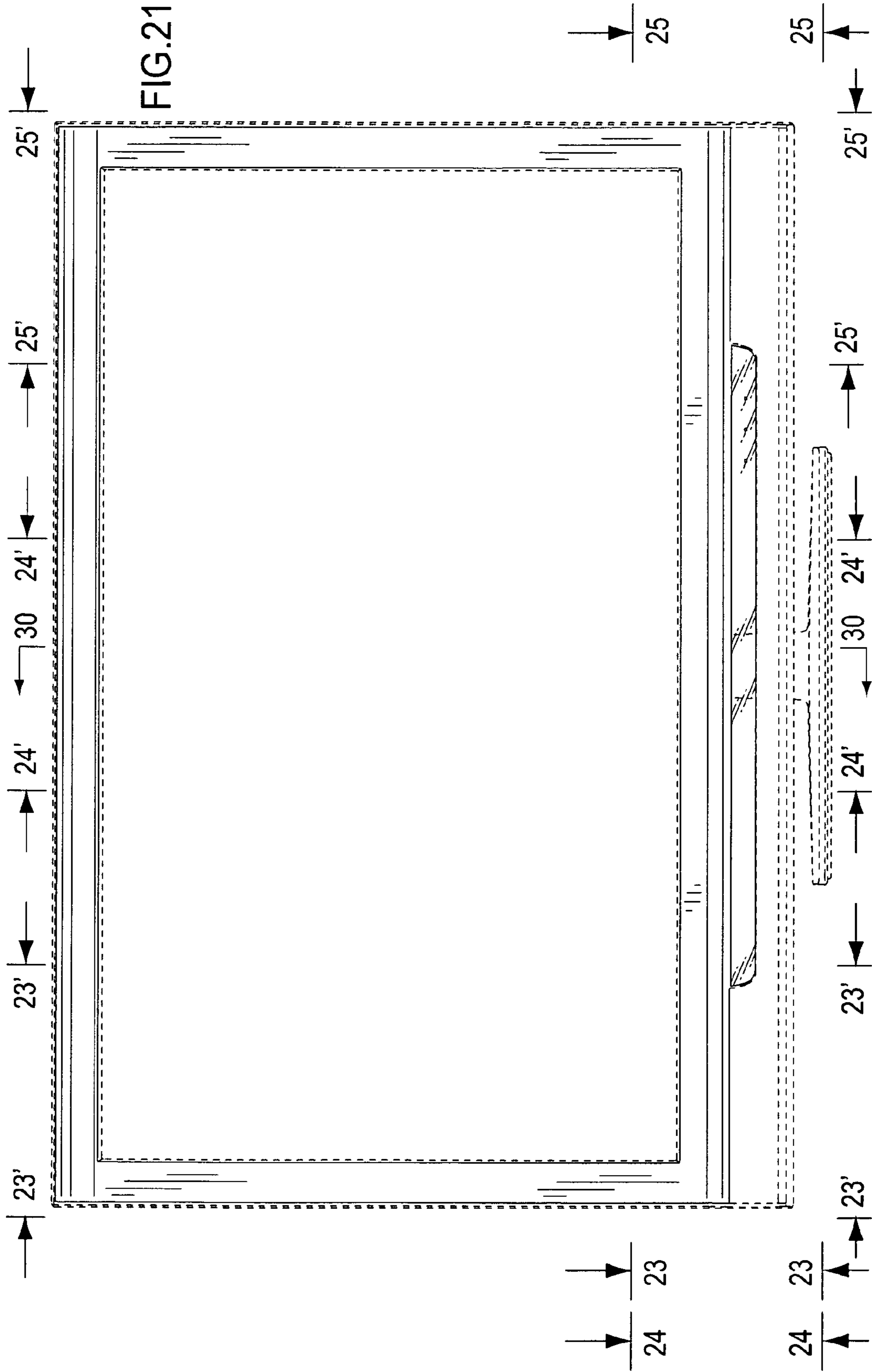

FIG.22

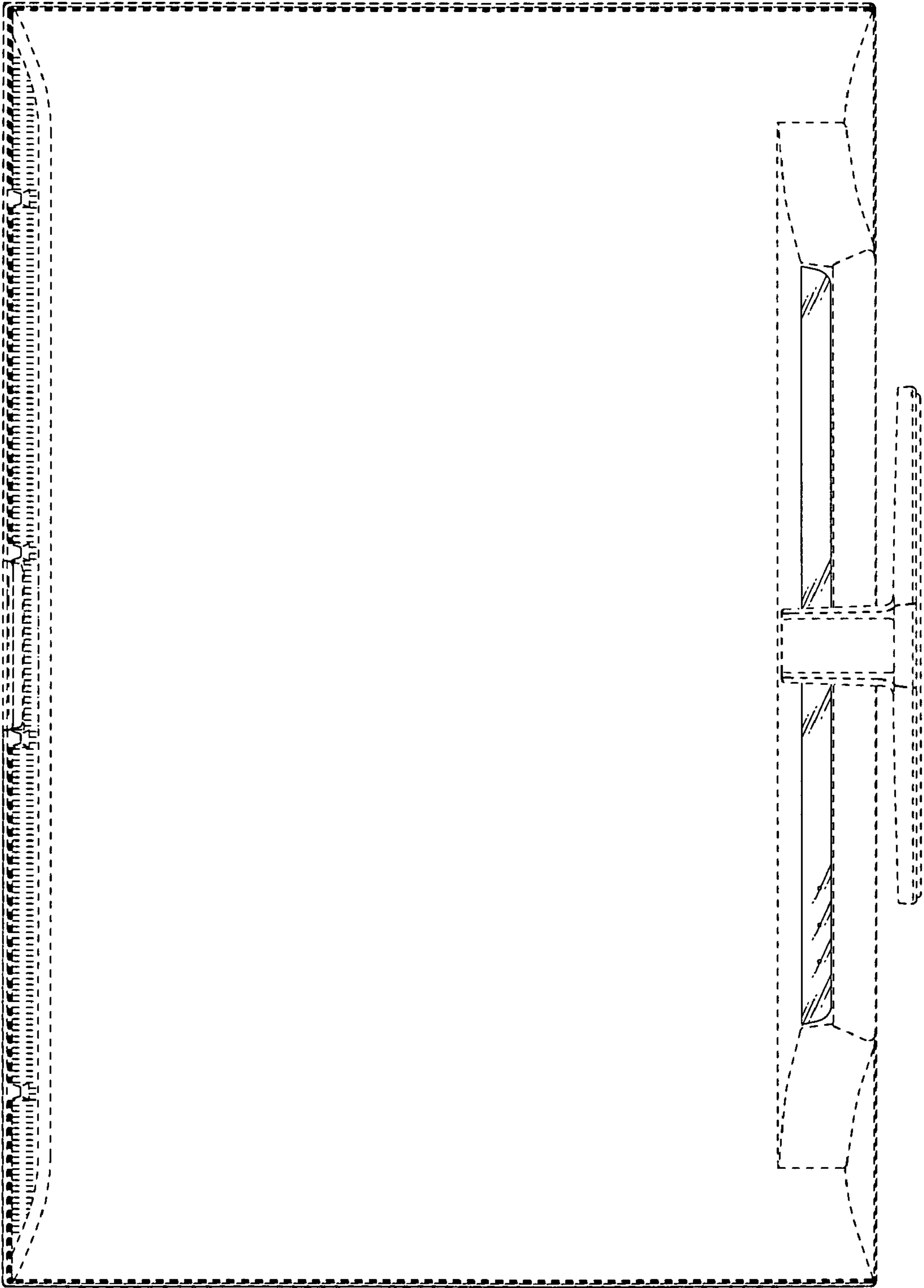

FIG.23

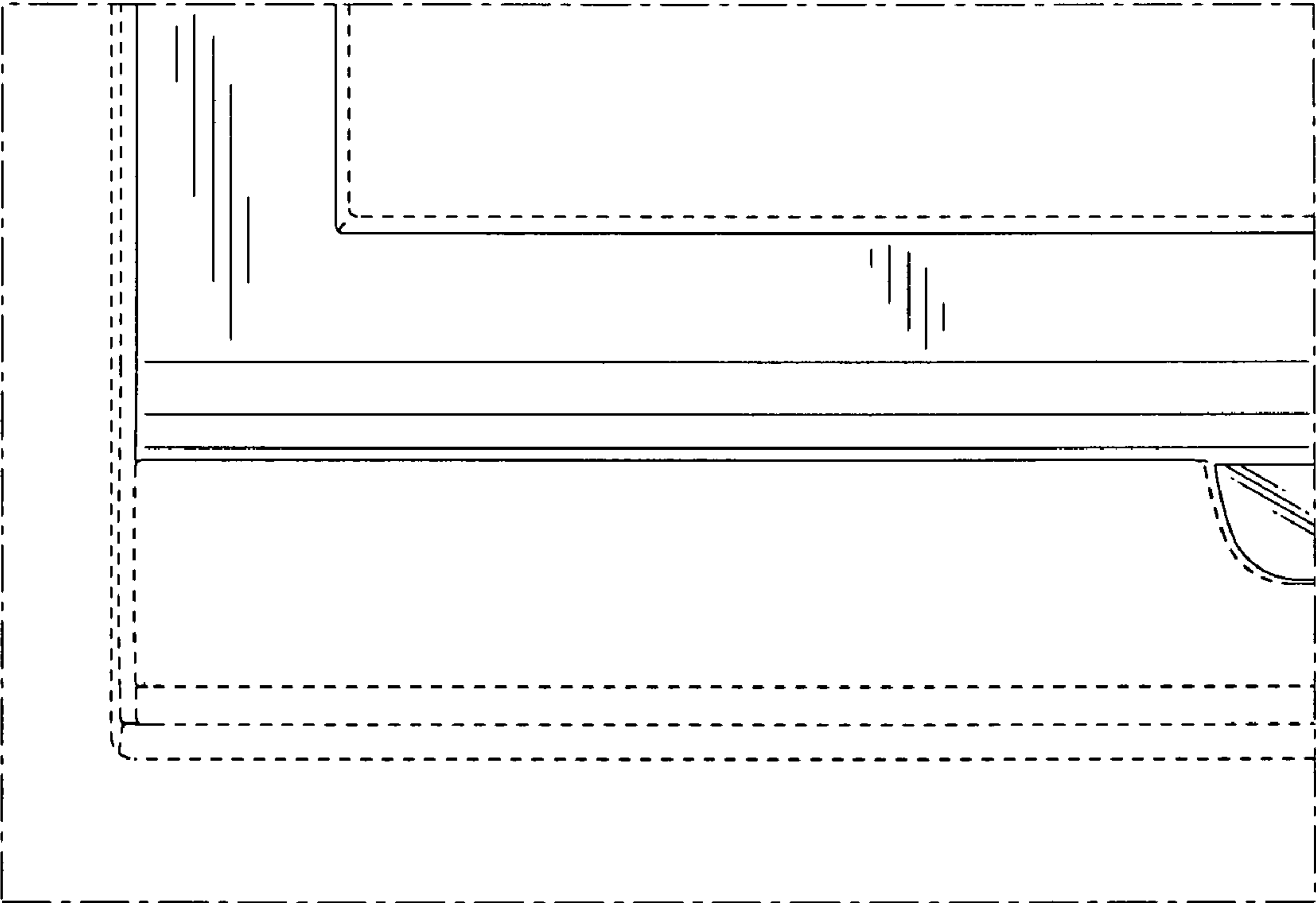

FIG.24

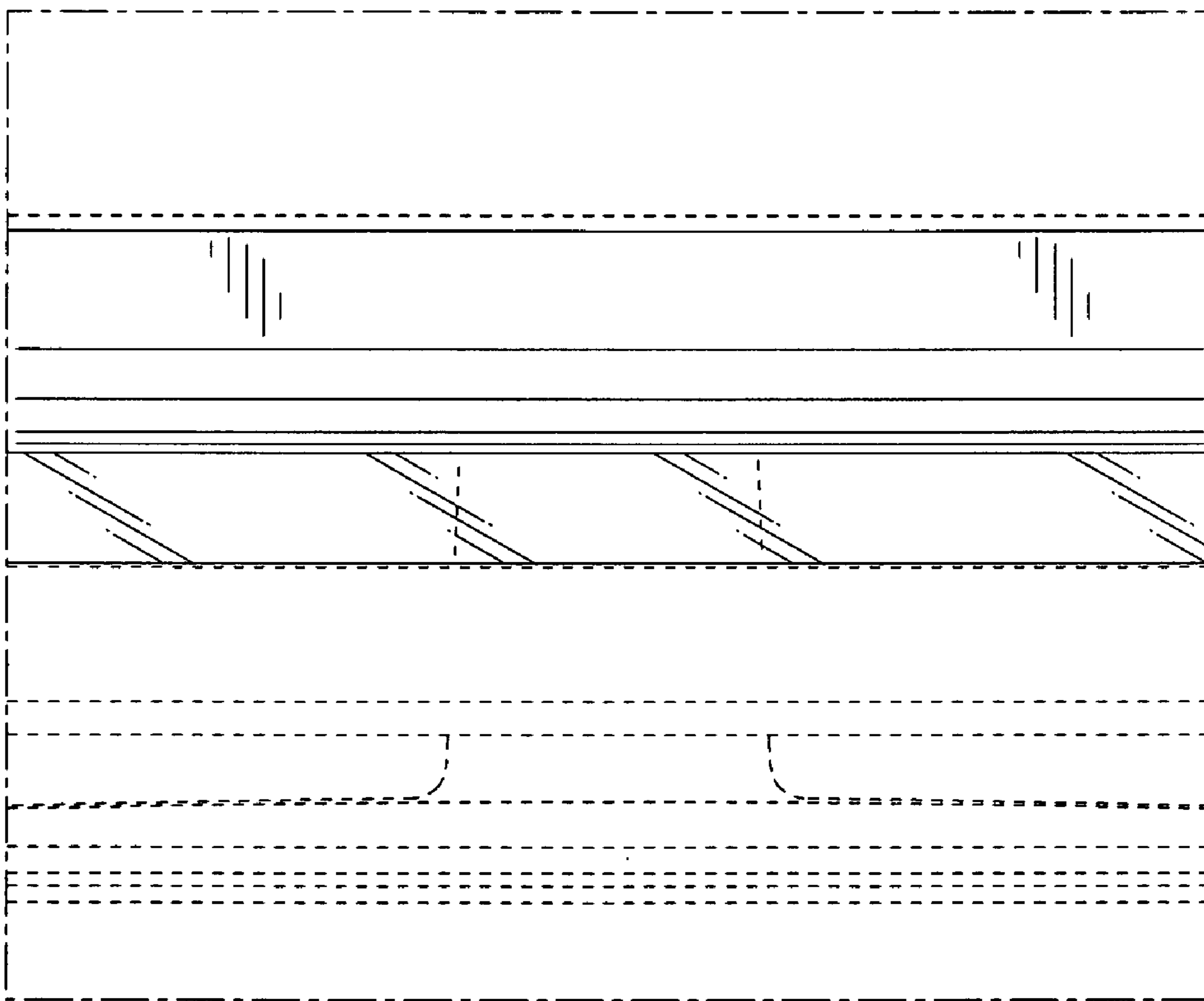

FIG.25

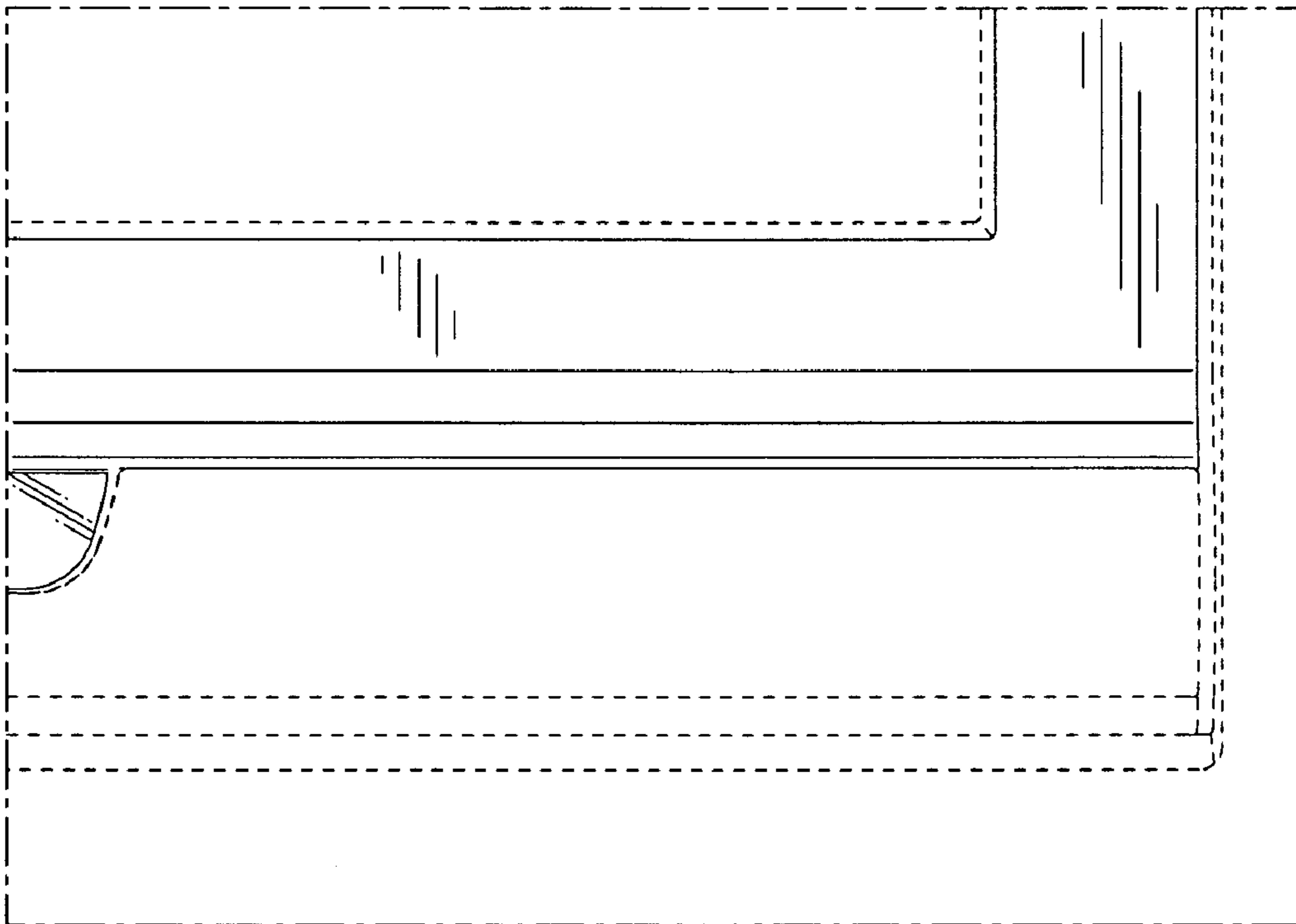

FIG.26

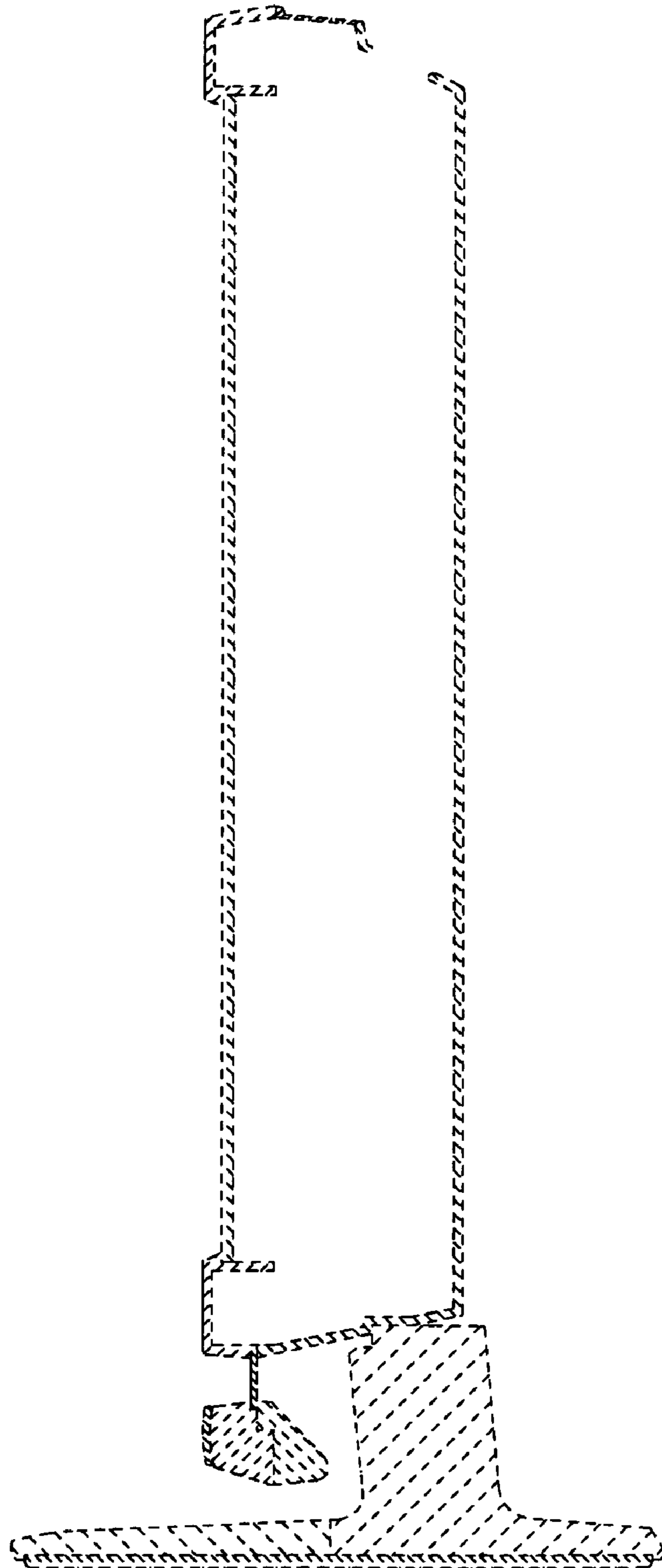

FIG.27

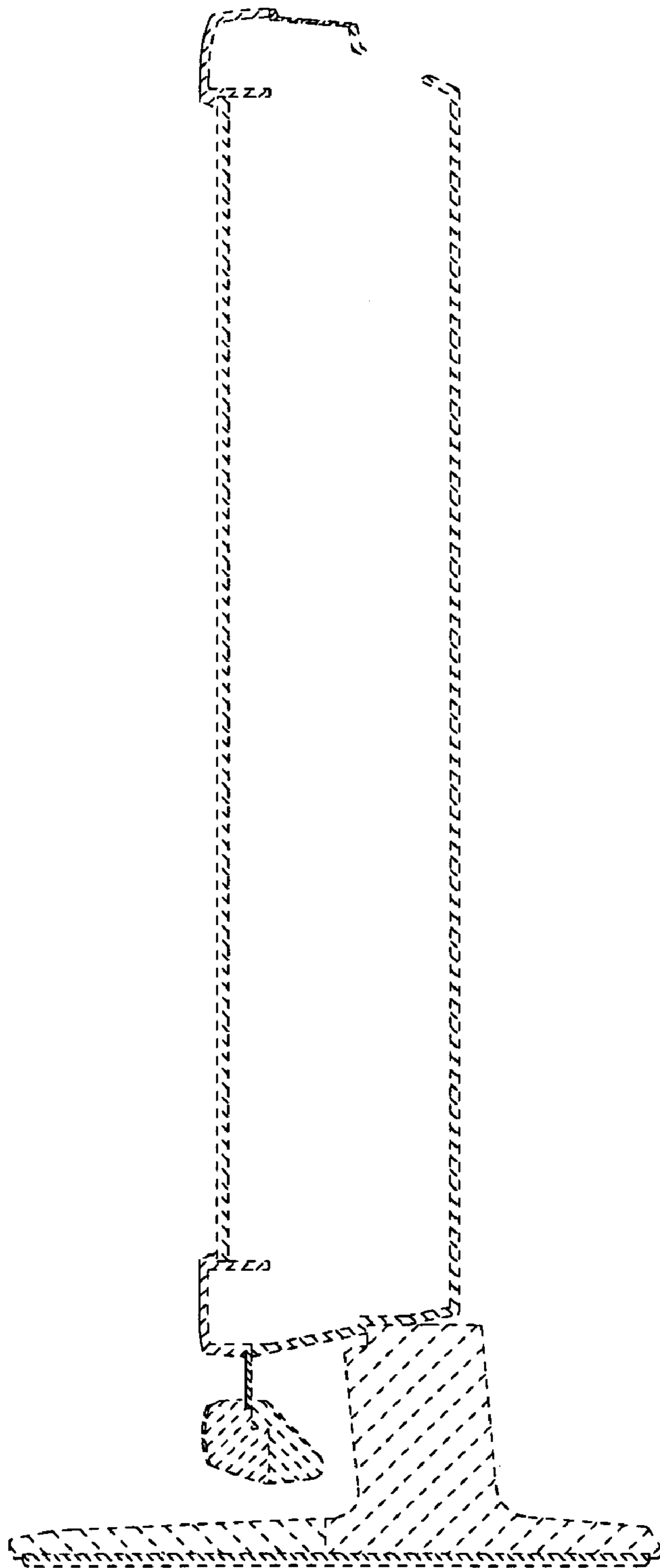

FIG.28

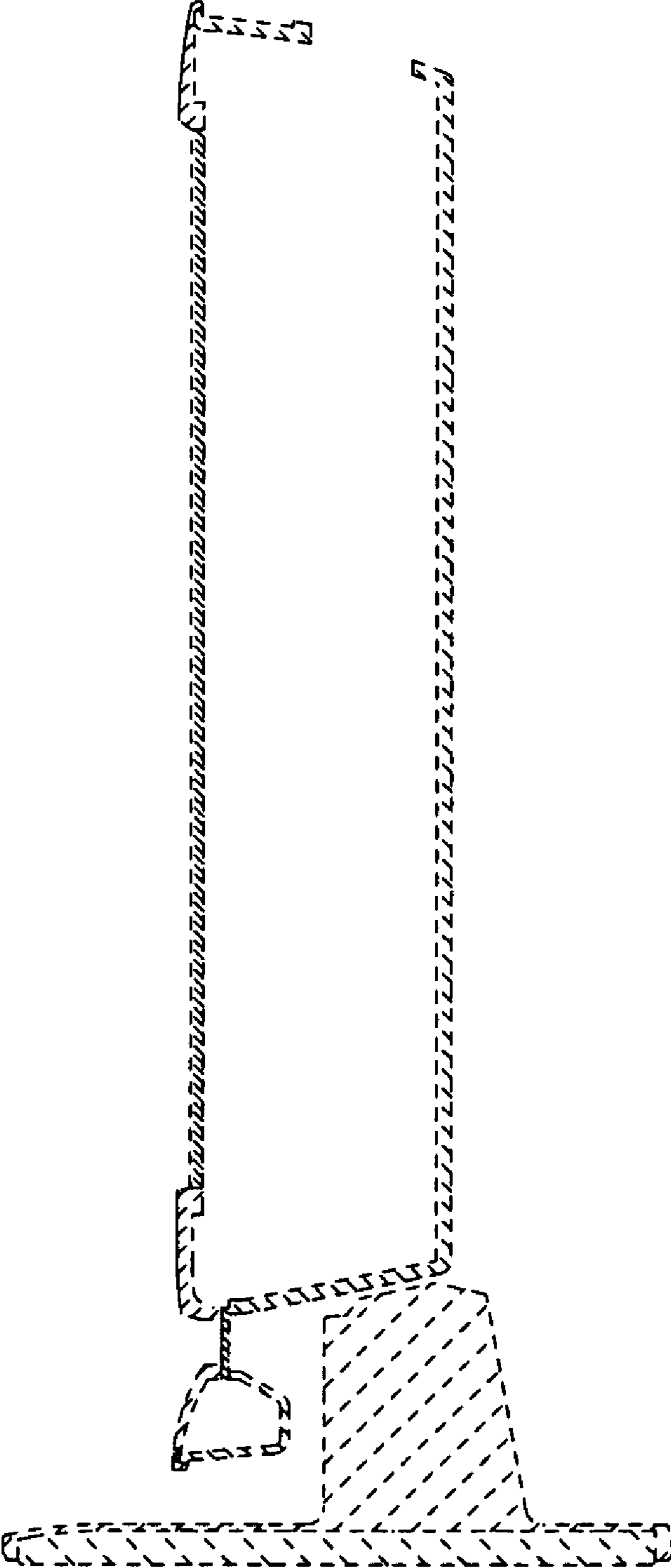

FIG.29

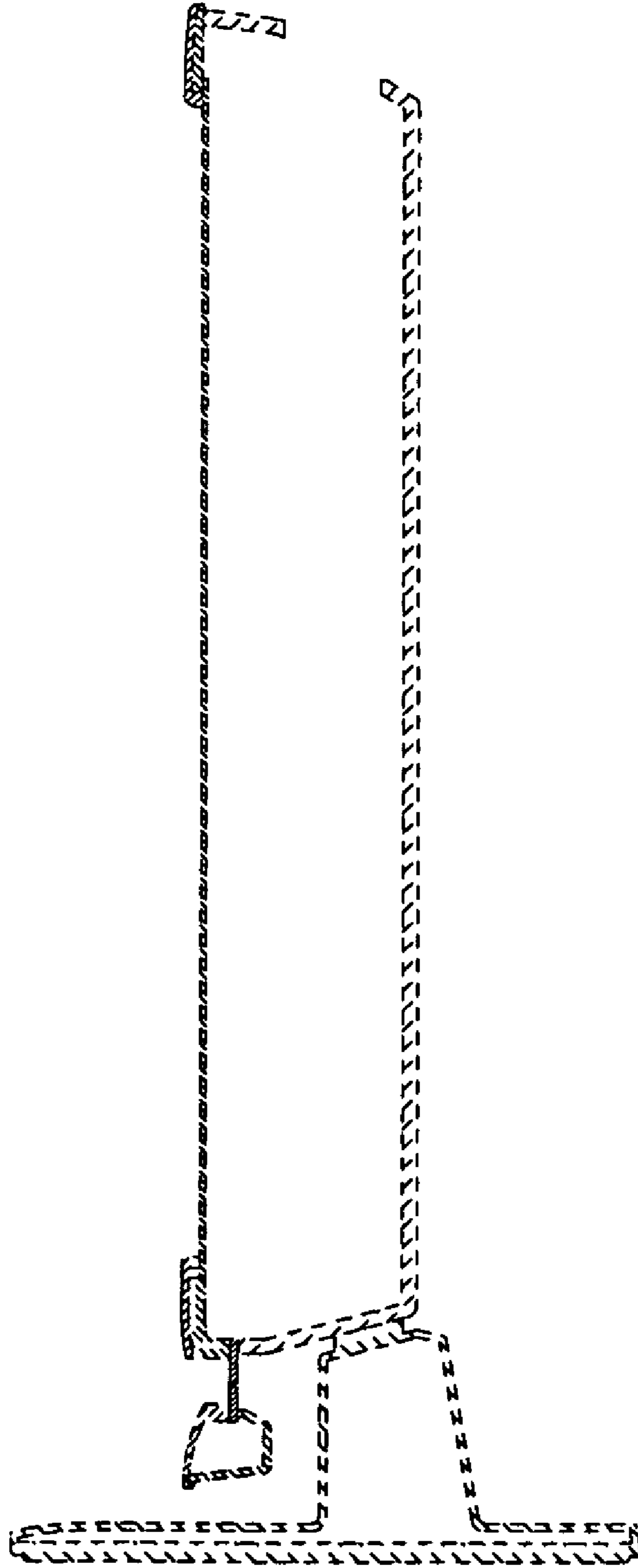

FIG.30

