



US00D666523S

(12) **United States Design Patent**
Dholakiya

(10) **Patent No.:** **US D666,523 S**

(45) **Date of Patent:** **** *Sep. 4, 2012**

(54) **GEMSTONE SETTING**

(76) Inventor: **Hasmukh Dholakiya**, New York, NY
(US)

(*) Notice: This patent is subject to a terminal disclaimer.

(**) Term: **14 Years**

(21) Appl. No.: **29/411,187**

(22) Filed: **Jan. 18, 2012**

(51) **LOC (9) Cl.** **11-01**

(52) **U.S. Cl.** **D11/91; D11/34**

(58) **Field of Classification Search** D11/1,
D11/2, 86-92, 26-43, 79, 80, 81; 63/12,
63/13, 14, 18, 26-28, 29.1, 29.2, 31, 32,
63/1.111

See application file for complete search history.

D552,011 S *	10/2007	Kothari	D11/91
7,461,452 B1 *	12/2008	Kothari	63/28
D620,387 S *	7/2010	Kothari	D11/91
7,762,104 B2 *	7/2010	Lin	63/28
D641,651 S *	7/2011	Kothari	D11/91
D642,088 S *	7/2011	Kothari	D11/91
D643,327 S *	8/2011	Kothari	D11/91
D643,767 S *	8/2011	Kothari	D11/34
D647,423 S *	10/2011	Khimavat	D11/91
D648,650 S *	11/2011	Roehl et al.	D11/91
D655,219 S *	3/2012	Kothari	D11/91

* cited by examiner

Primary Examiner — Cathron Brooks

Assistant Examiner — Melanie Pellegrini

(74) *Attorney, Agent, or Firm* — Jennifer Meredith, Esq.;
Meredith & Keyhani, PLLC

(57) **CLAIM**

I claim the ornamental design for the gemstone setting, as shown and described.

(56) **References Cited**

U.S. PATENT DOCUMENTS

D153,530 S *	4/1949	Kinsley	D11/92
D337,546 S *	7/1993	Keshishian	D11/93
D391,516 S *	3/1998	Kothari	D11/75
D417,636 S *	12/1999	Ambar	D11/40
D444,098 S *	6/2001	Hurwitz	D11/90
D445,058 S *	7/2001	Kaplan	D11/91
D447,080 S *	8/2001	Itzkowitz	D11/40
D473,816 S *	4/2003	Gurevich	D11/91
D496,604 S *	9/2004	Pinto et al.	D11/91
D505,092 S *	5/2005	Kothari	D11/91
D529,837 S *	10/2006	Shum	D11/91
D544,809 S *	6/2007	Shah	D11/91
D549,128 S *	8/2007	Kothari	D11/91
D549,612 S *	8/2007	Kothari	D11/91

DESCRIPTION

FIG. 1 is a top and front perspective view of gemstone setting showing my new design;
FIG. 2 is a rear elevational view thereof;
FIG. 3 is a side elevational view thereof;
FIG. 4 is a top plan view thereof;
FIG. 5 is a top and front perspective view thereof shown in an alternate environment; and,
FIG. 6 is a right side perspective view shown in an alternate environment.
The broken lines shown in the drawings represent environmental matter and form no part of the claimed design.

1 Claim, 4 Drawing Sheets

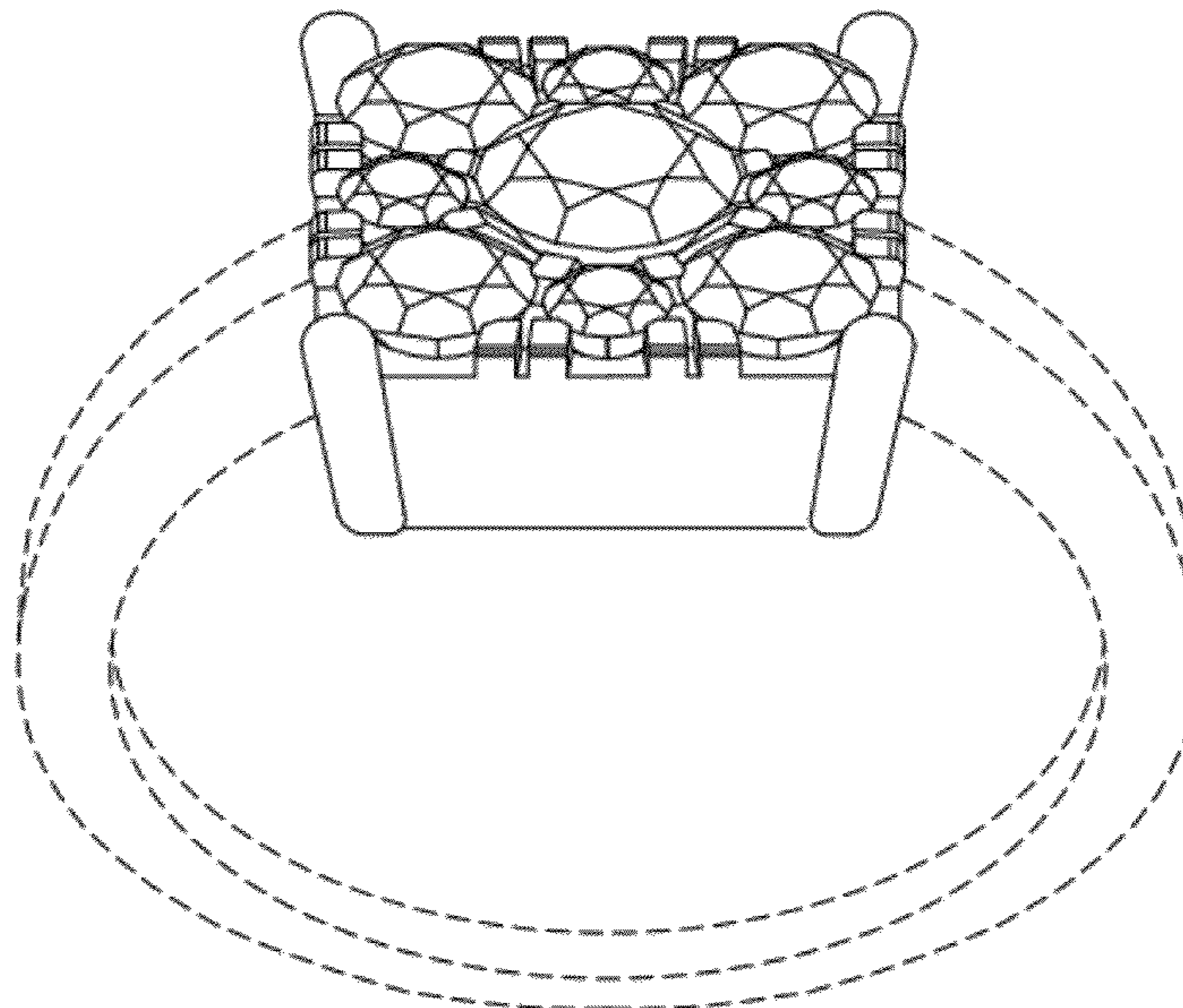

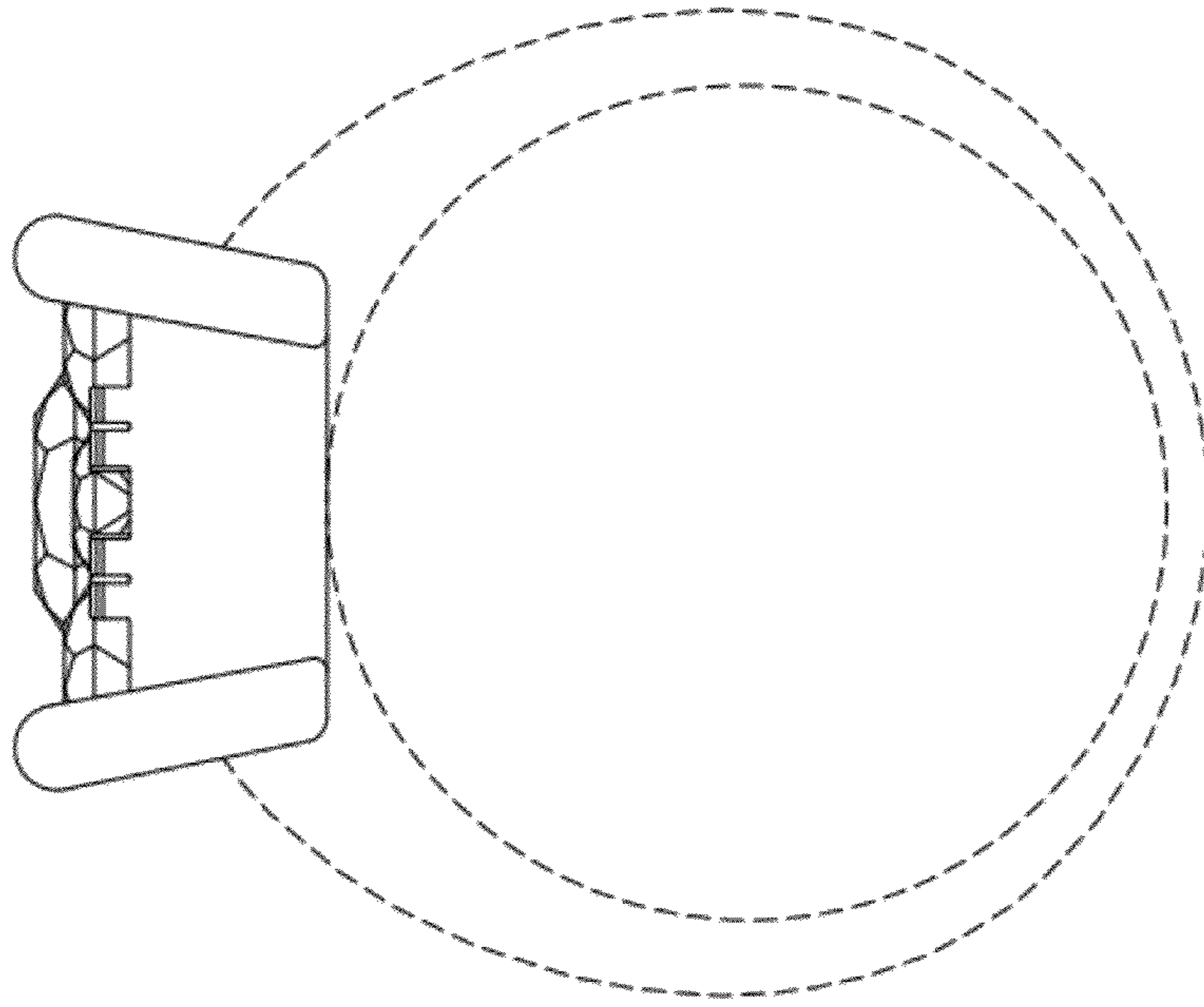

FIG. 2

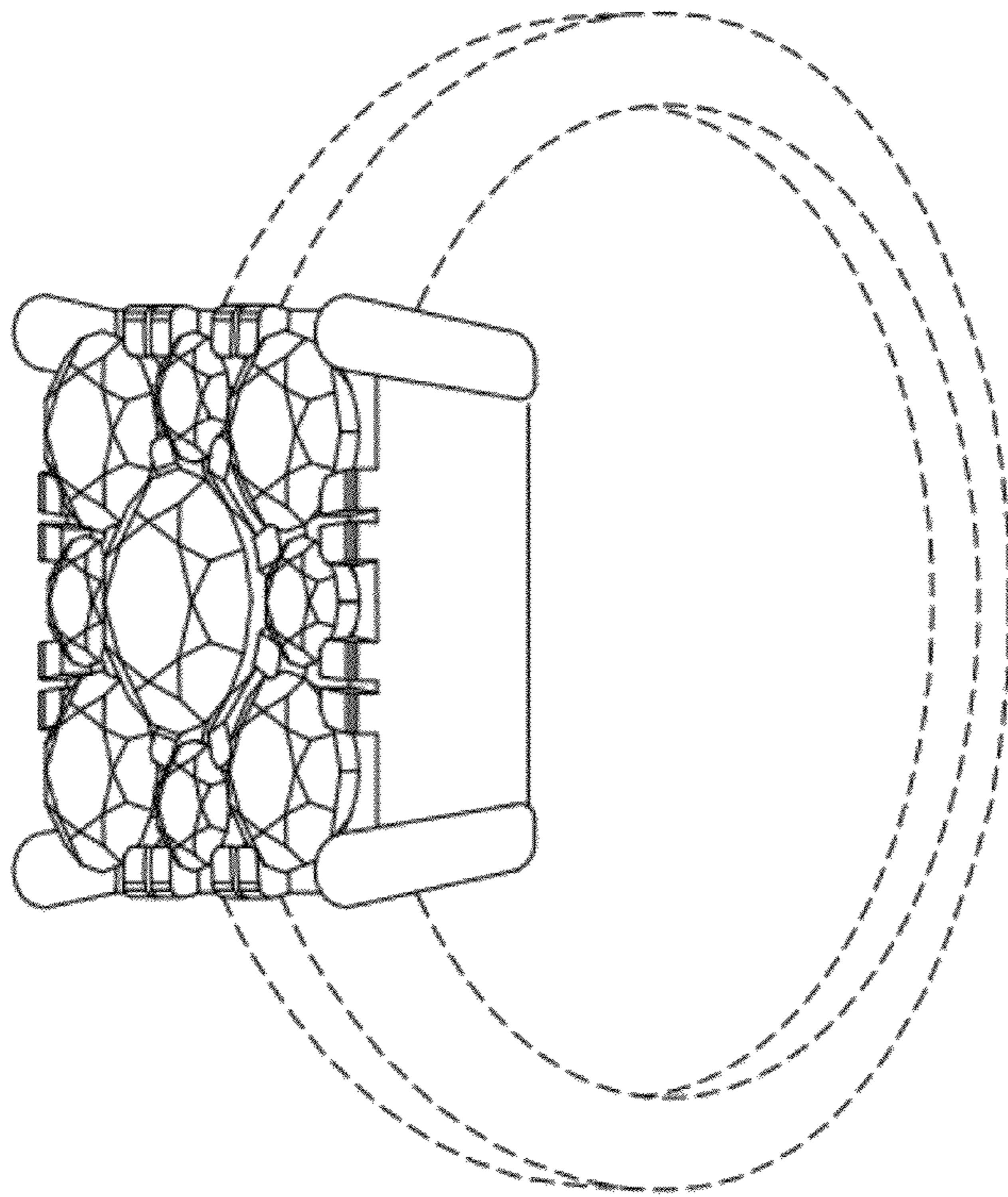

FIG. 1

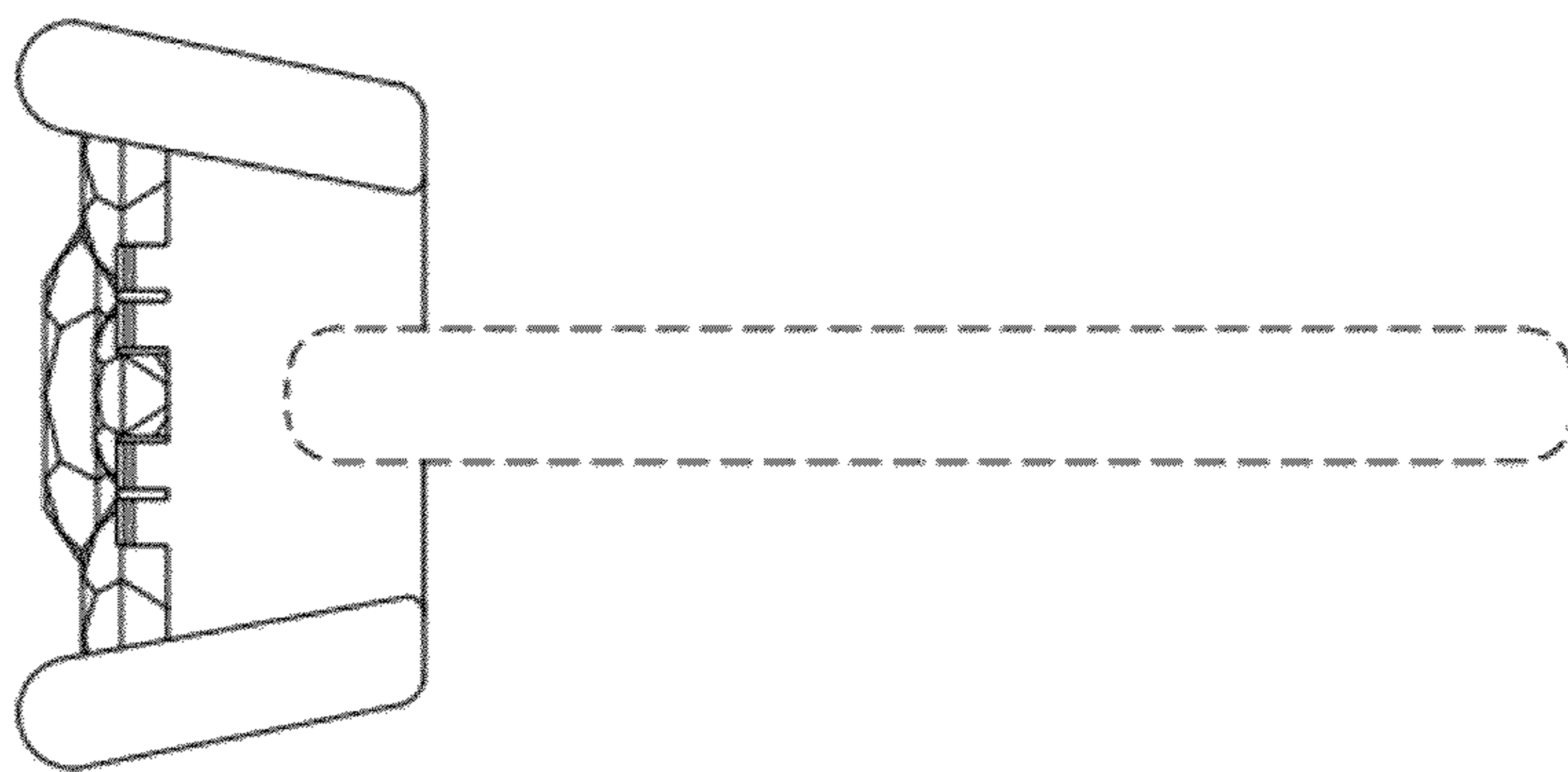

FIG. 3

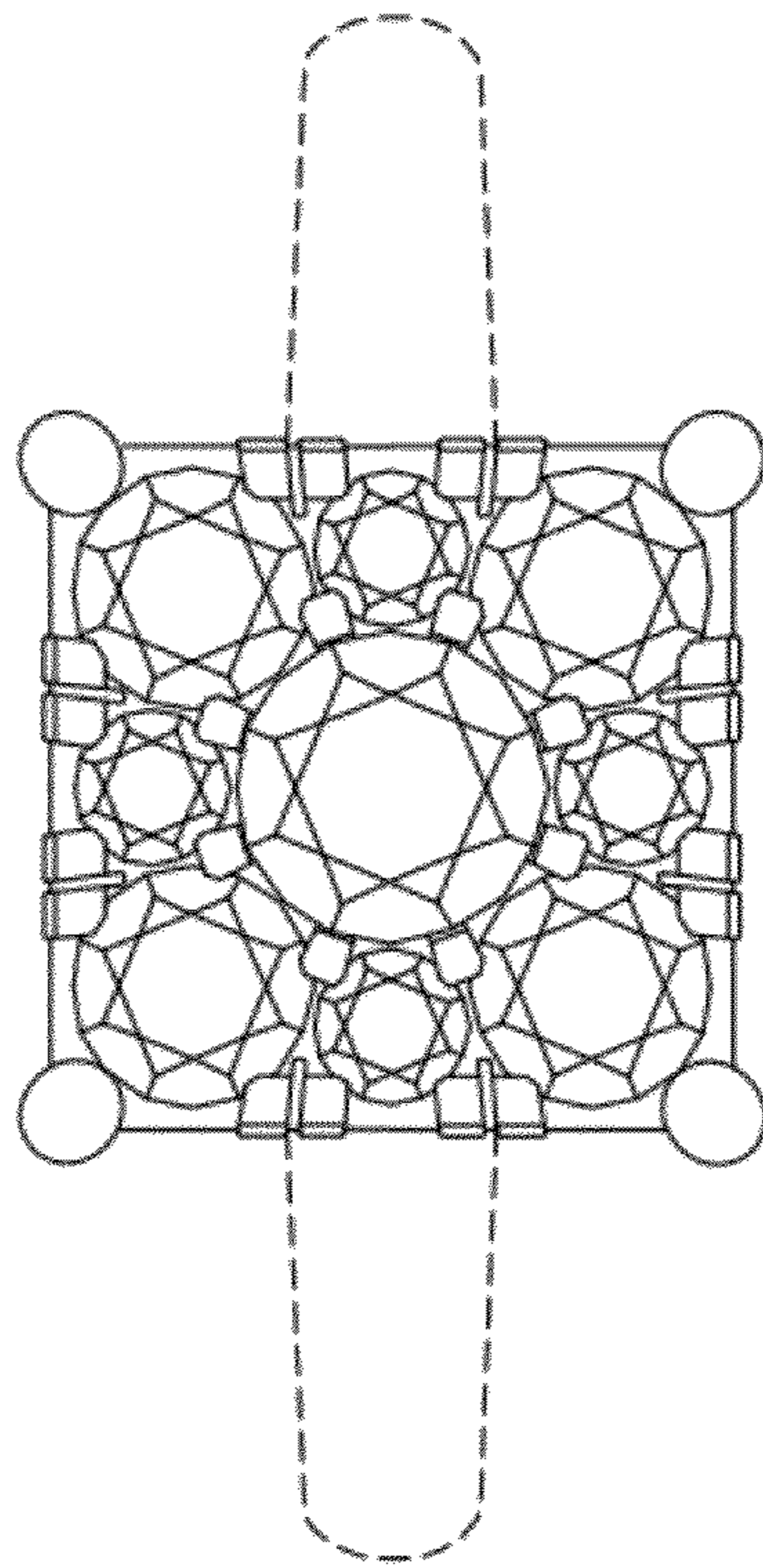

FIG. 4

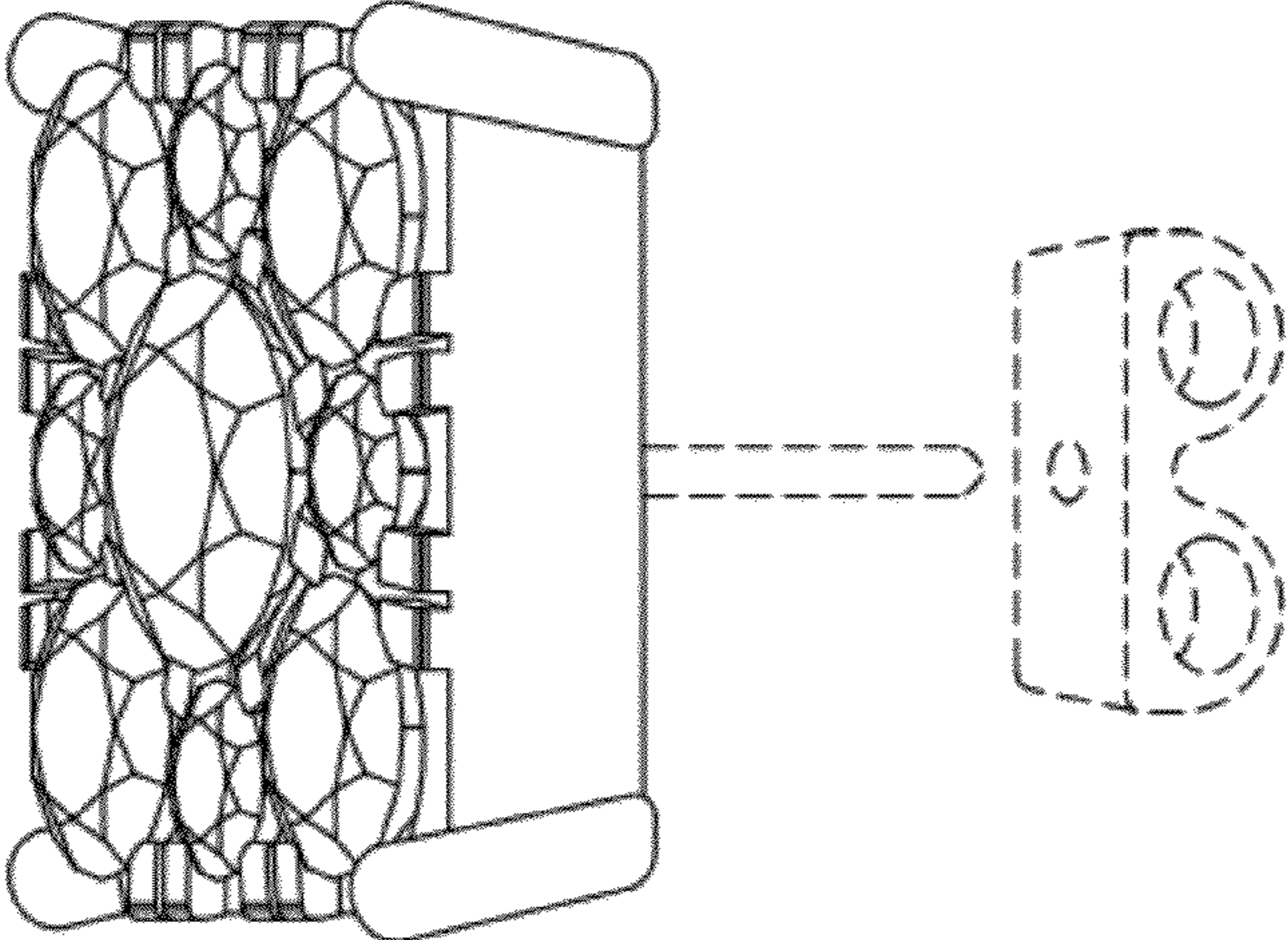

FIG. 5

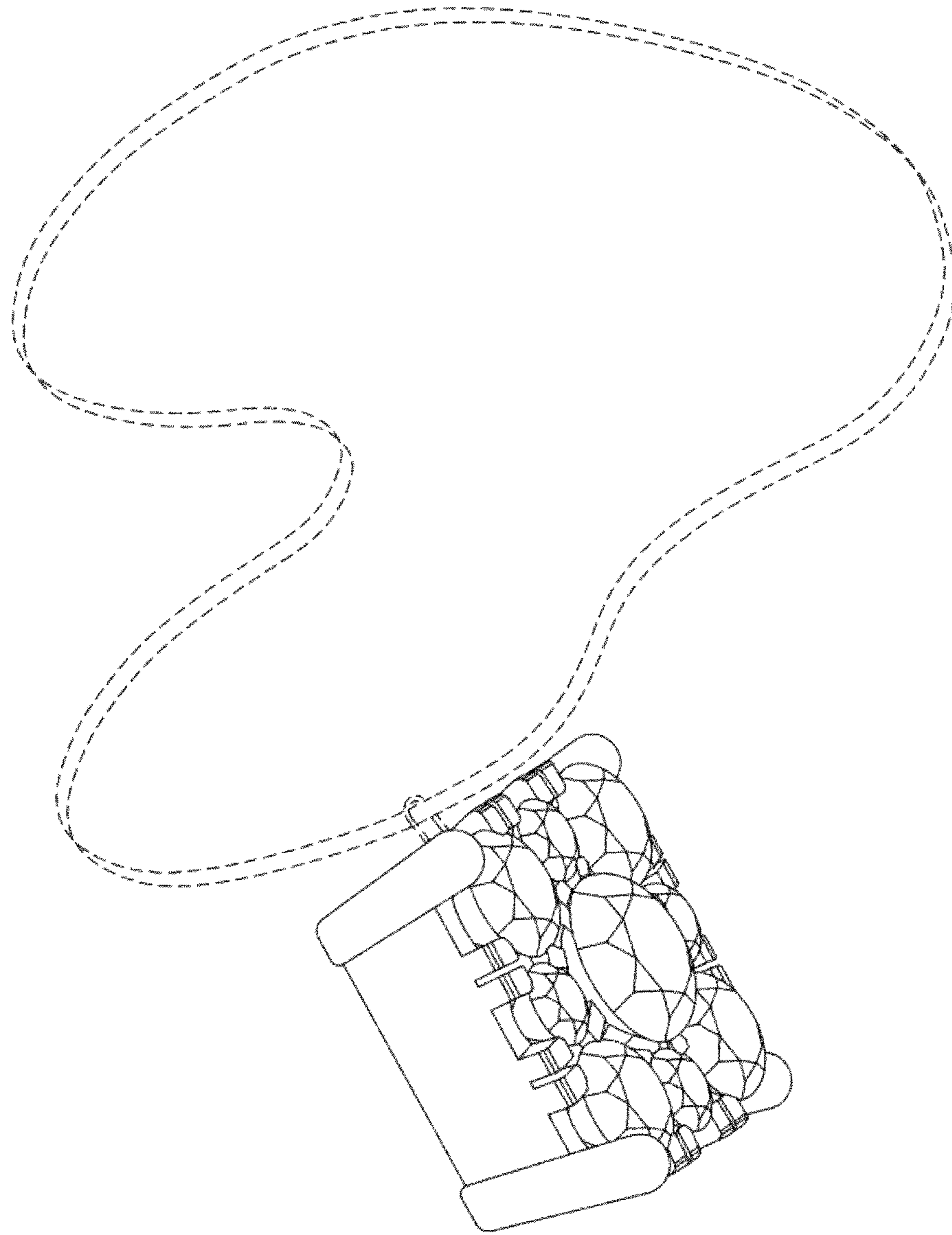

FIG. 6