

US00D666460S

(12) **United States Design Patent**  
**Kolano**

(10) **Patent No.:** **US D666,460 S**

(45) **Date of Patent:** **\*\* Sep. 4, 2012**

(54) **FOOD CONTAINER**

(75) Inventor: **William Kolano**, Pittsburgh, PA (US)

(73) Assignee: **Hutzler Manufacturing Co., Inc.**,  
Canaan, CT (US)

(\*\*) Term: **14 Years**

(21) Appl. No.: **29/409,708**

(22) Filed: **Dec. 28, 2011**

(51) **LOC (9) Cl.** ..... **07-07**

(52) **U.S. Cl.** ..... **D7/628; D9/645**

(58) **Field of Classification Search** ..... D7/601,  
D7/602, 628, 629, 630, 612-615, 538-542;  
D9/645; 206/457; 220/780-806, 669-673,  
220/675, 574-575, 326, 236

See application file for complete search history.

(56) **References Cited**

**U.S. PATENT DOCUMENTS**

4,795,033 A \* 1/1989 Duffy ..... 206/457  
D512,582 S \* 12/2005 Scholze et al. .... D9/645  
D605,471 S \* 12/2009 Ehrenhaus et al. .... D7/628

D611,774 S \* 3/2010 Yung ..... D7/628  
D611,775 S \* 3/2010 Yung ..... D7/628  
D611,777 S \* 3/2010 Yung ..... D7/628

\* cited by examiner

*Primary Examiner* — Terry Wallace

(74) *Attorney, Agent, or Firm* — Michael J. Striker

(57) **CLAIM**

The ornamental design for the food container, as shown and described.

**DESCRIPTION**

FIG. 1 is a three-quarter exploded perspective view of a food container showing my new design;  
FIG. 2 is a front exploded elevation thereof;  
FIG. 3 is a back exploded elevation view thereof;  
FIG. 4 is a left side exploded elevation view thereof;  
FIG. 5 is a right side exploded elevation view thereof;  
FIG. 6 is a top plan exploded view thereof;  
FIG. 7 is a bottom plan exploded view thereof; and,  
FIG. 8 is a three-quarter perspective view thereof showing my new design in attached form.

**1 Claim, 8 Drawing Sheets**

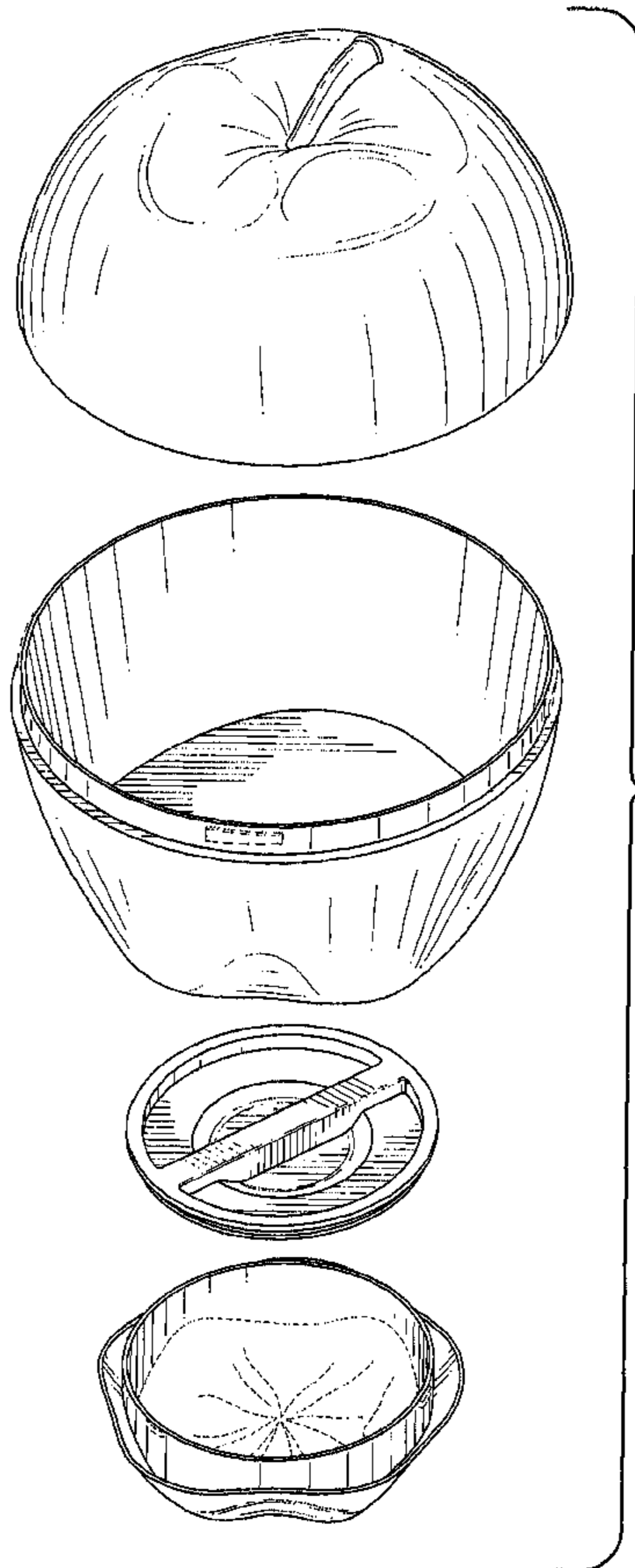

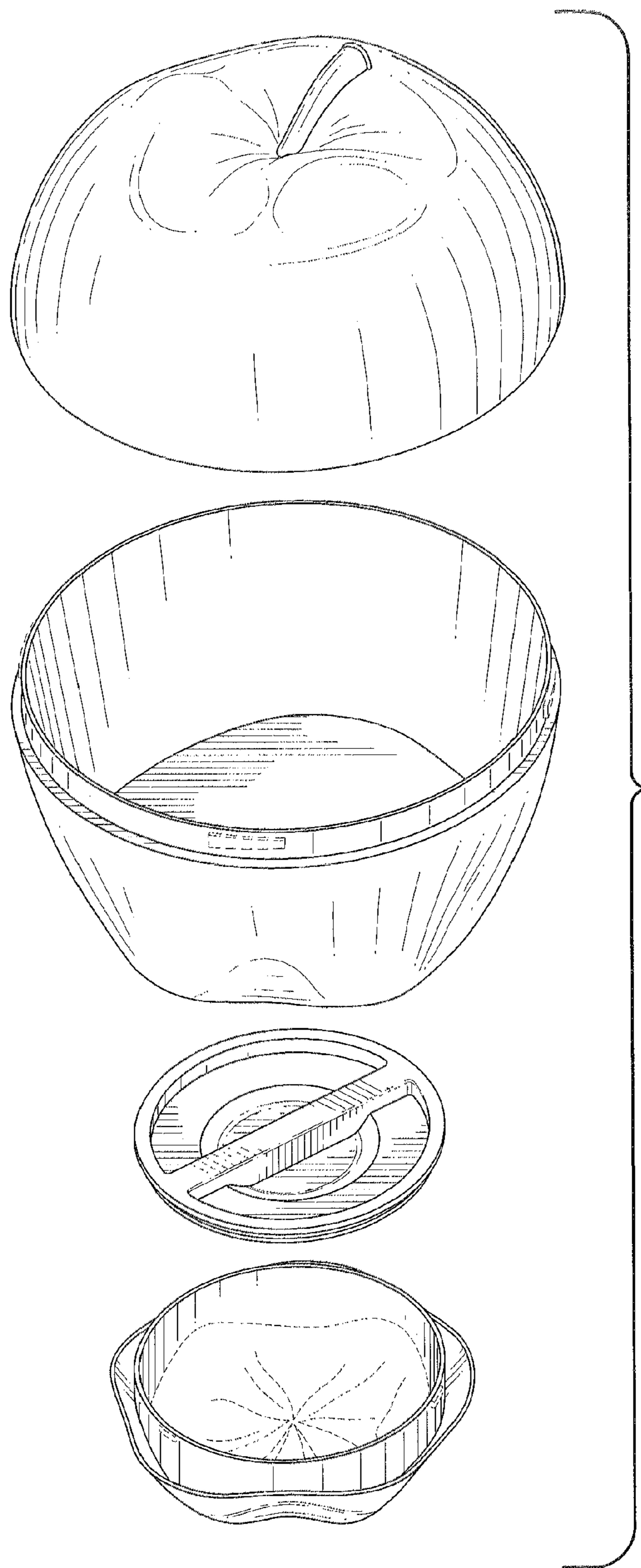

FIG. 1

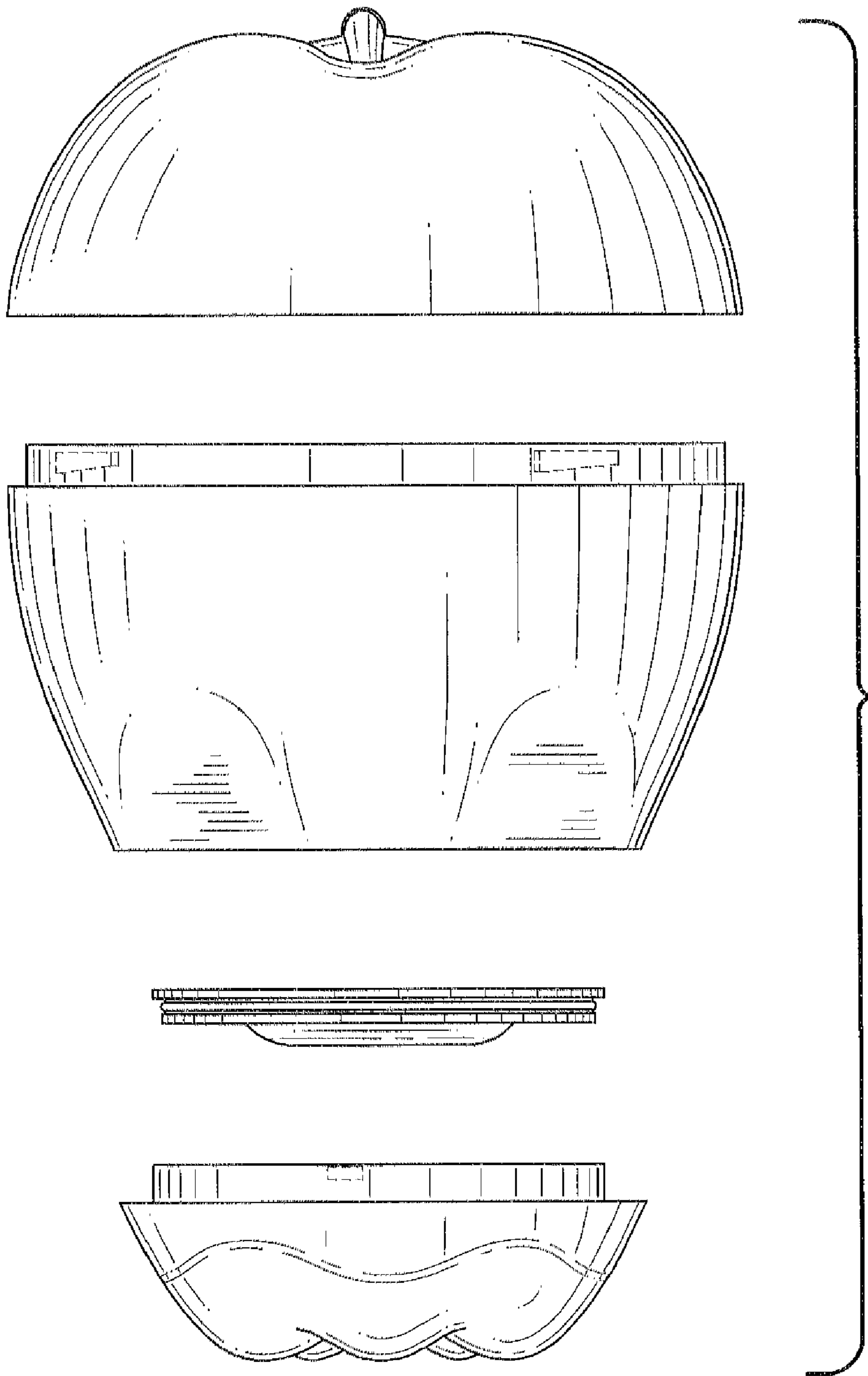

FIG. 2

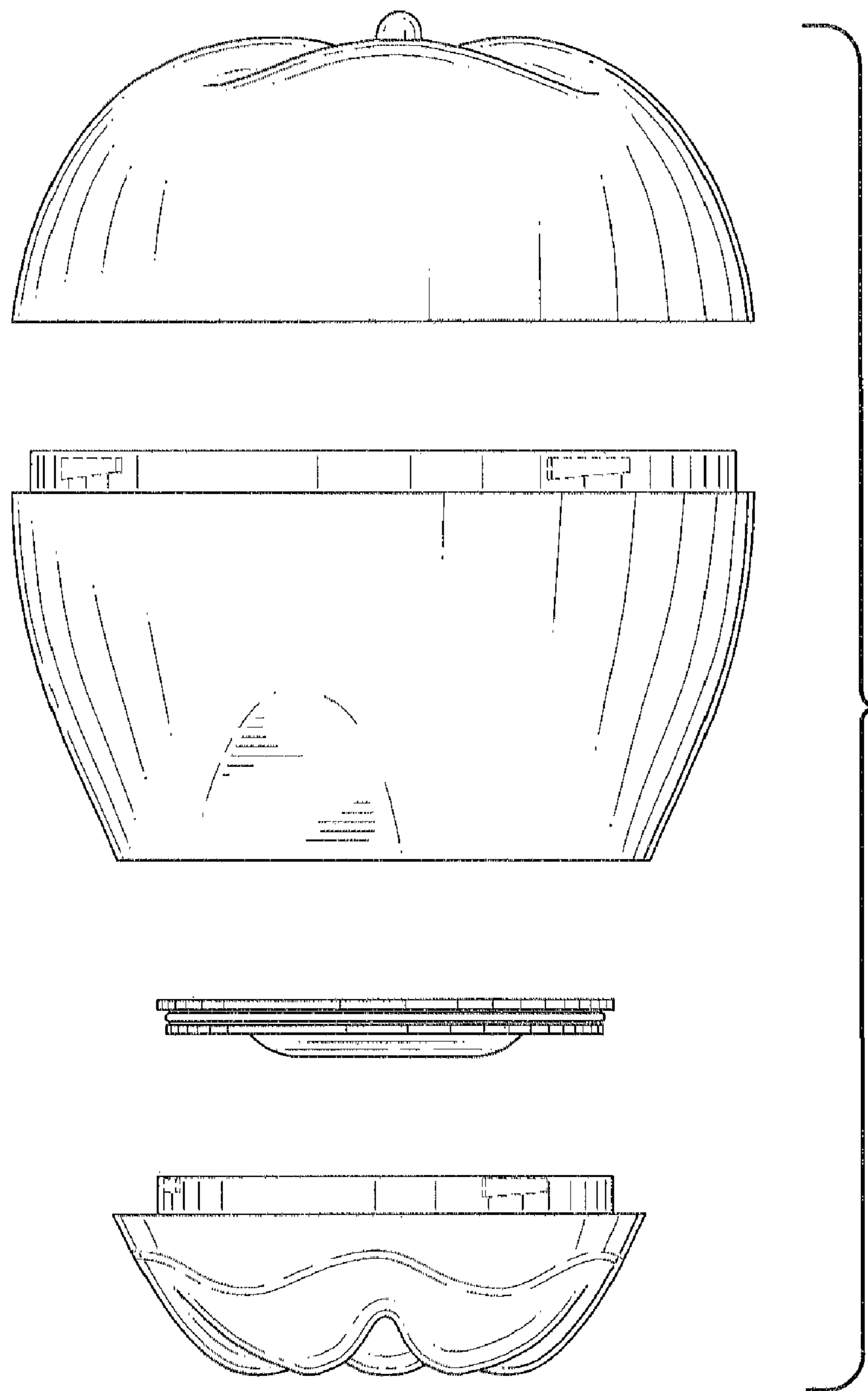

FIG. 3

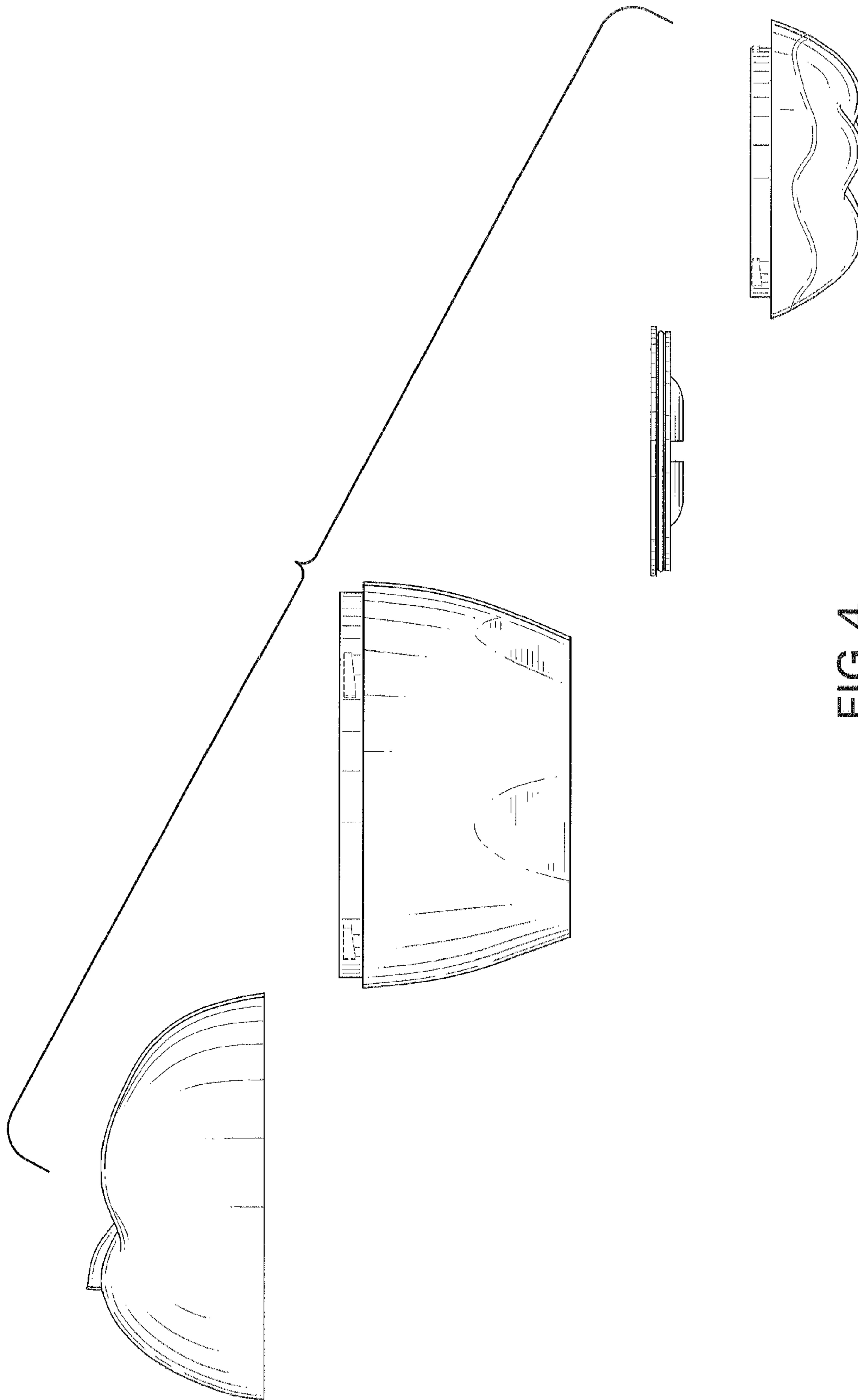

FIG.4

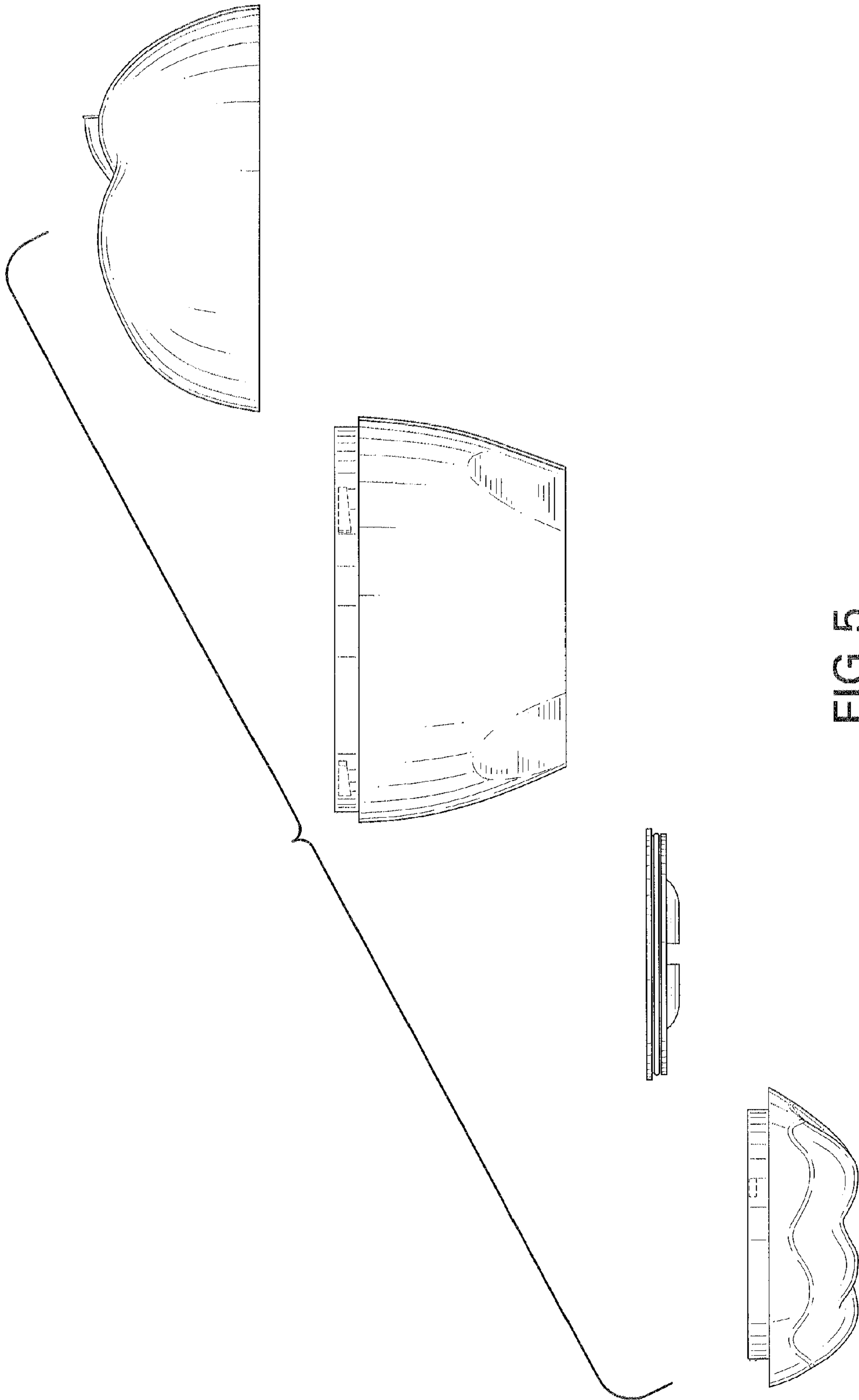

FIG. 5

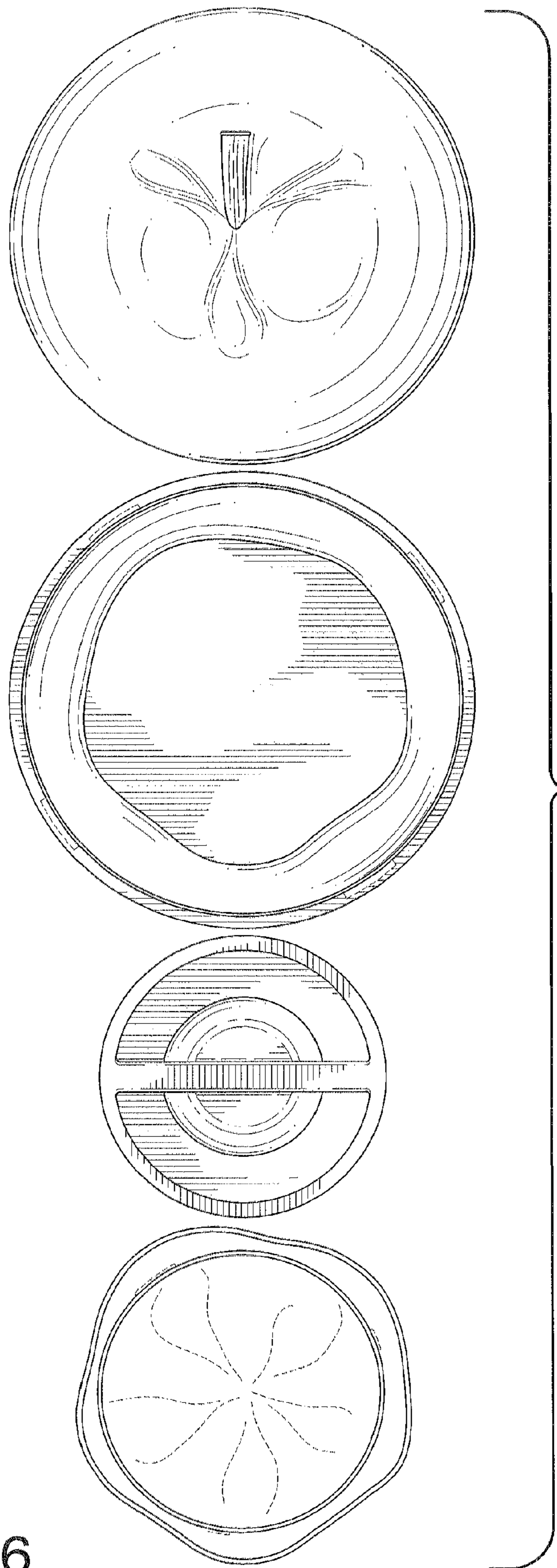

FIG. 6

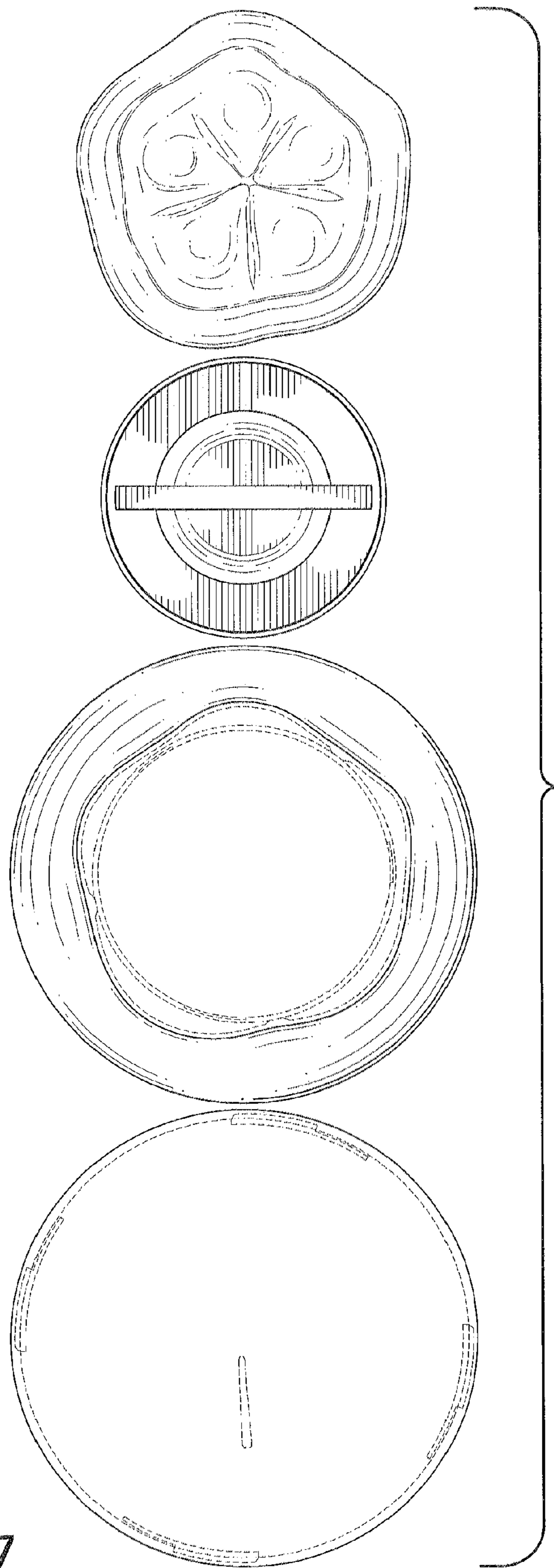

FIG. 7



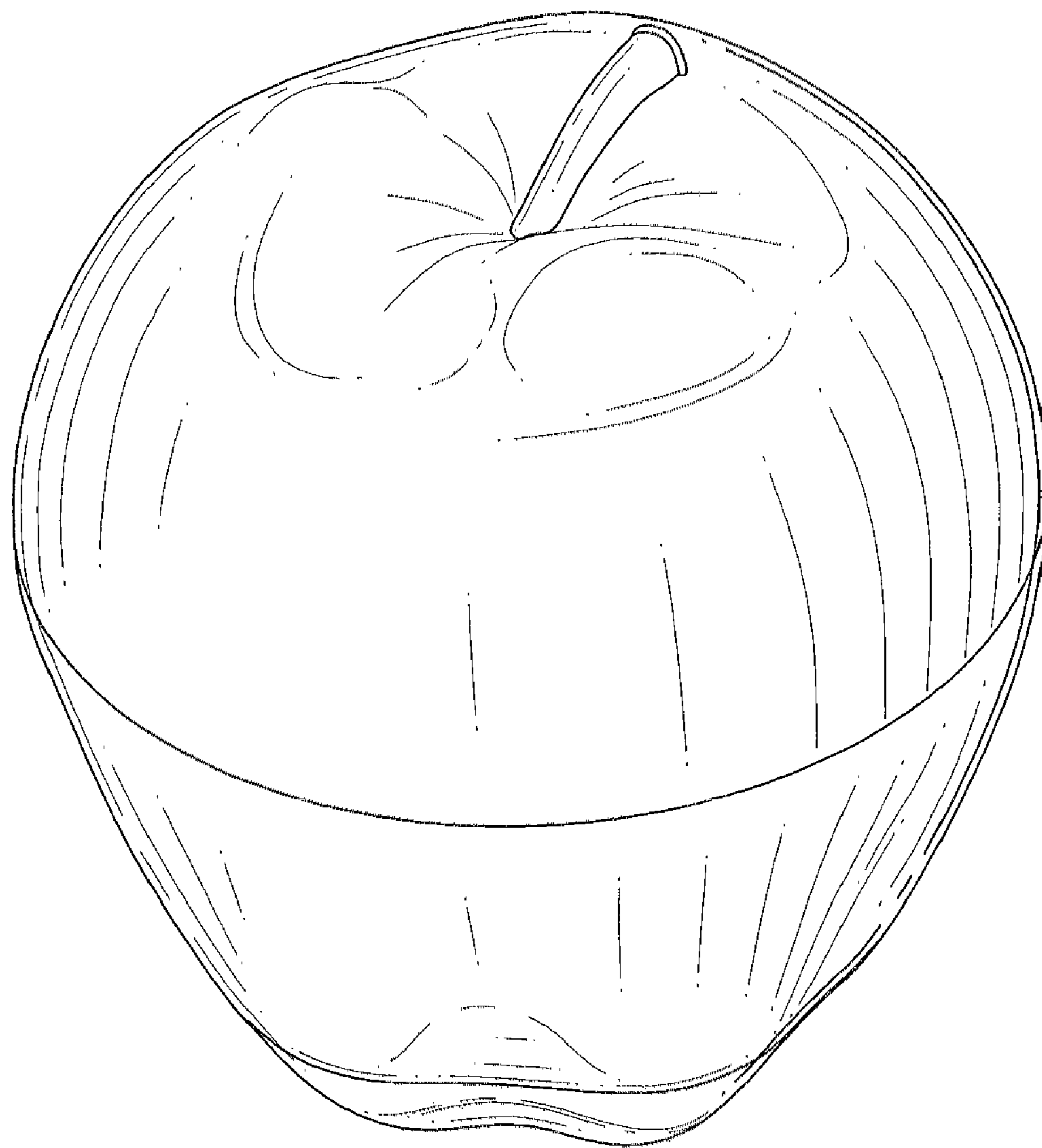

FIG. 8