

US00D666446S

(12) **United States Design Patent**
McShane

(10) **Patent No.:** **US D666,446 S**

(45) **Date of Patent:** **** Sep. 4, 2012**

(54) **PUZZLE SHELF**

(75) **Inventor:** **Arthur E. McShane**, Port Jefferson Station, NY (US)

(73) **Assignee:** **Art Works and Design, Inc.**, Port Jefferson Station, NY (US)

(**) **Term:** **14 Years**

(21) **Appl. No.:** **29/403,583**

(22) **Filed:** **Oct. 7, 2011**

(51) **LOC (9) Cl.** **06-04**

(52) **U.S. Cl.** **D6/574**

(58) **Field of Classification Search** D6/553,
D6/567, 574, 566; 211/13.1, 14, 42, 71.01,
211/86.01, 88.01, 88.03, 90.01, 90.03, 126.1,
211/133.5, 134, 153, 182; 108/28-29; 248/35,
248/309.1; D11/133; D21/480
See application file for complete search history.

(56) **References Cited**

U.S. PATENT DOCUMENTS

- 5,588,240 A * 12/1996 Zilliox D21/480
- D393,556 S * 4/1998 Jordan D6/574
- D541,549 S * 5/2007 Ng et al. D6/574

* cited by examiner

Primary Examiner — Brian N Vinson

(74) *Attorney, Agent, or Firm* — Richard A. Castellano;
PRASS LLP

(57) **CLAIM**

The ornamental design for a puzzle shelf, as shown and described.

DESCRIPTION

FIG. 1 is a front perspective view of a puzzle shelf showing my new design in accordance with a first embodiment;
 FIG. 2 is front view thereof;
 FIG. 3 is a right side view thereof;
 FIG. 4 is a left side view thereof;
 FIG. 5 is a top elevation thereof;
 FIG. 6 is a bottom elevation view thereof;
 FIG. 7 is a rear view thereof;
 FIG. 8 is a front perspective view of a puzzle shelf showing my new design in accordance with a second embodiment;
 FIG. 9 is a front view thereof;
 FIG. 10 is a right side view thereof;
 FIG. 11 is a left side view thereof;
 FIG. 12 is a top elevation view thereof;
 FIG. 13 is a bottom elevation view thereof; and,
 FIG. 14 is a rear view thereof.

The broken-line disclosure is understood to represent portions of the article in which the claimed design is embodied, but which forms no part of the claimed design. The claimed design is understood to be limited to areas on which surface shading is provided, and where a broken-line abuts a claimed surface, that line is understood to represent an unclaimed boundary between claimed and unclaimed surfaces.

1 Claim, 10 Drawing Sheets

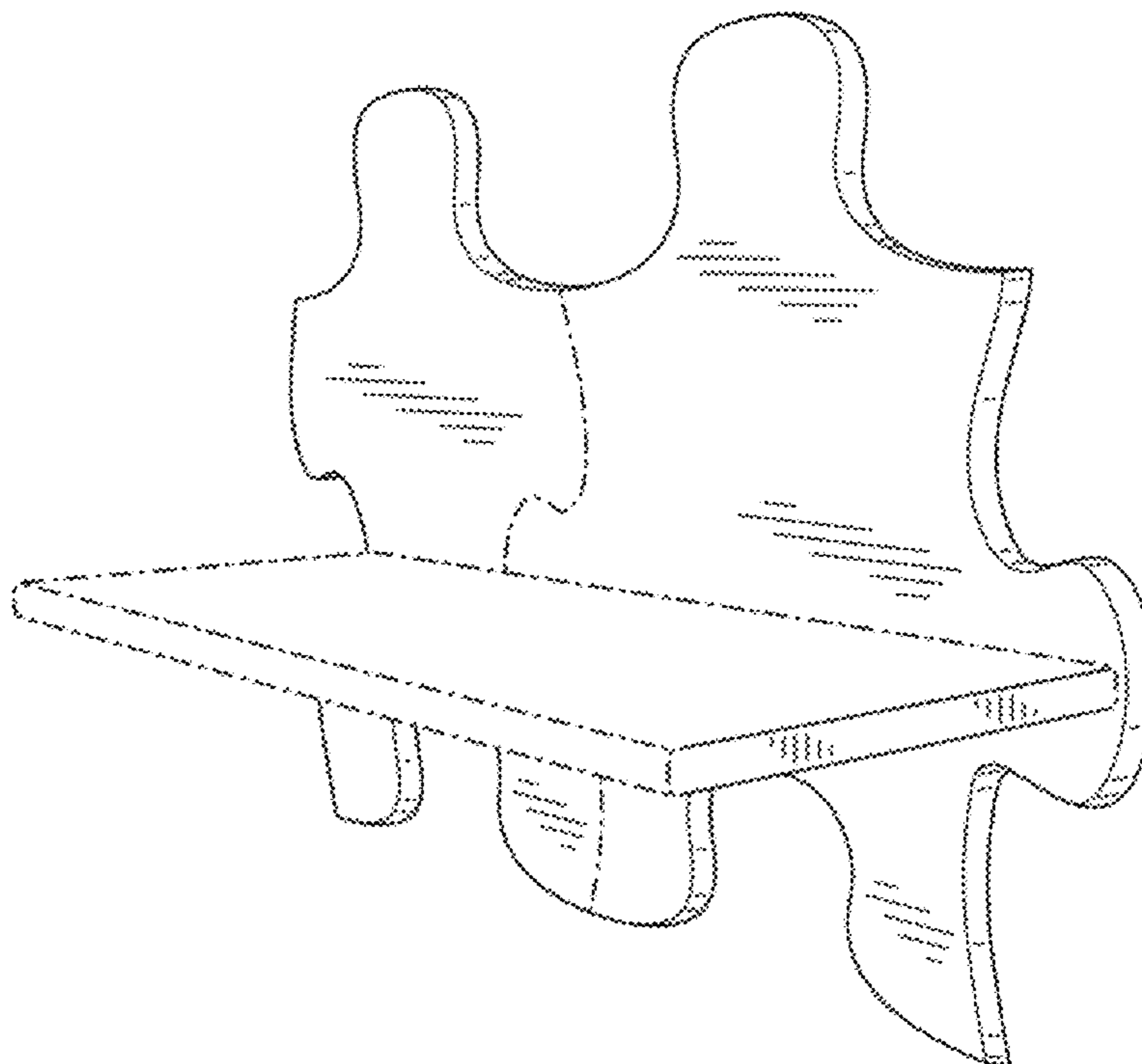

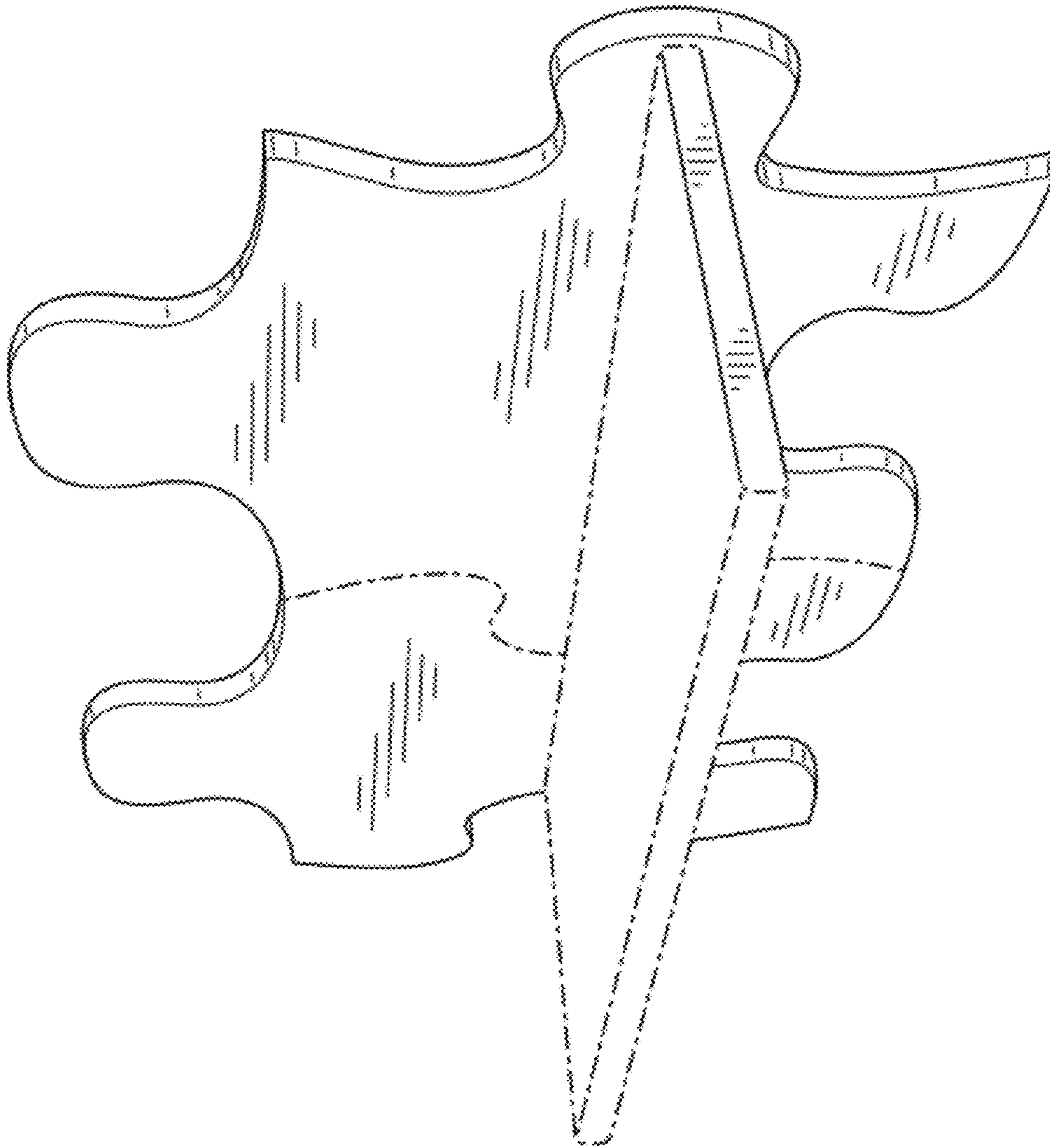

FIG. 1

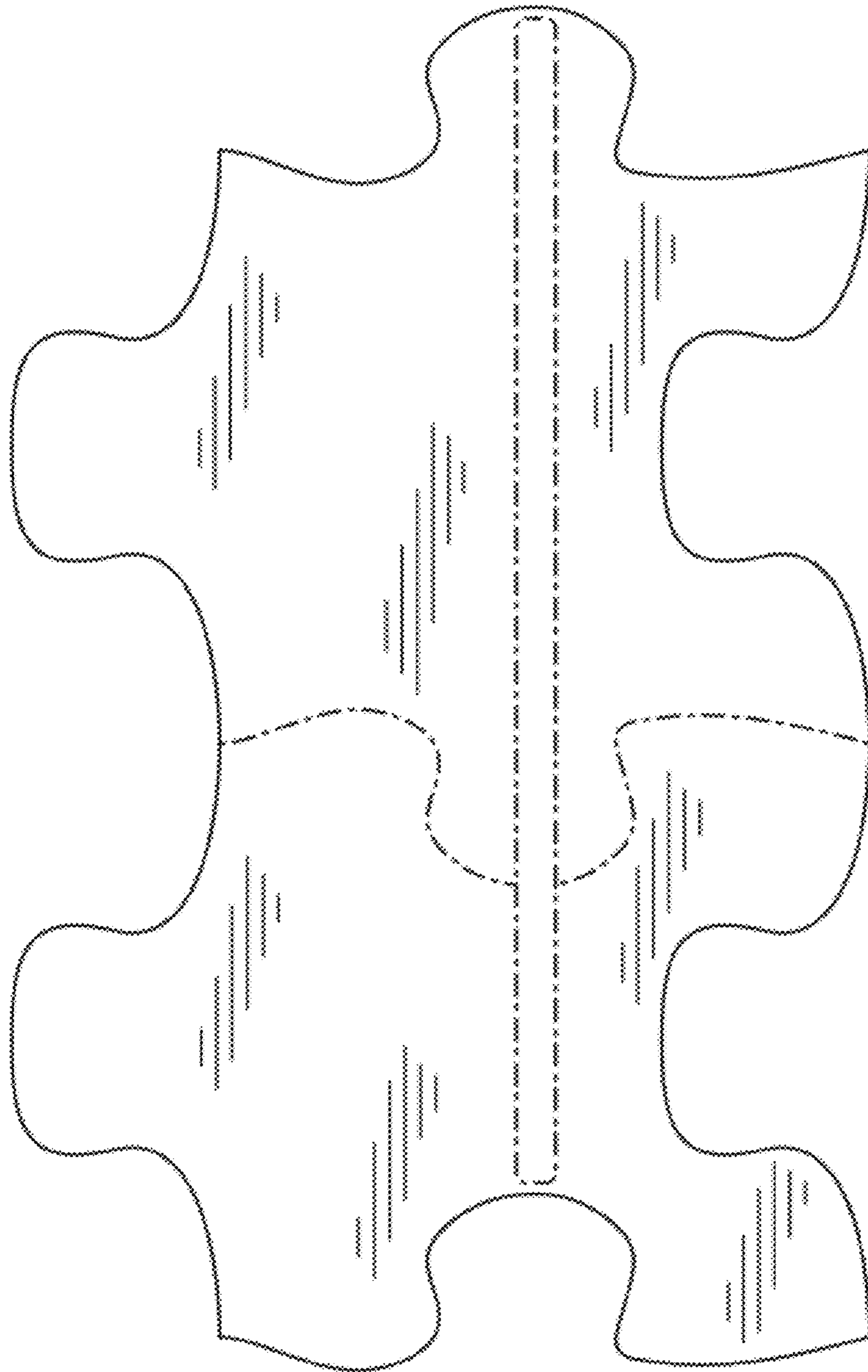

FIG. 2

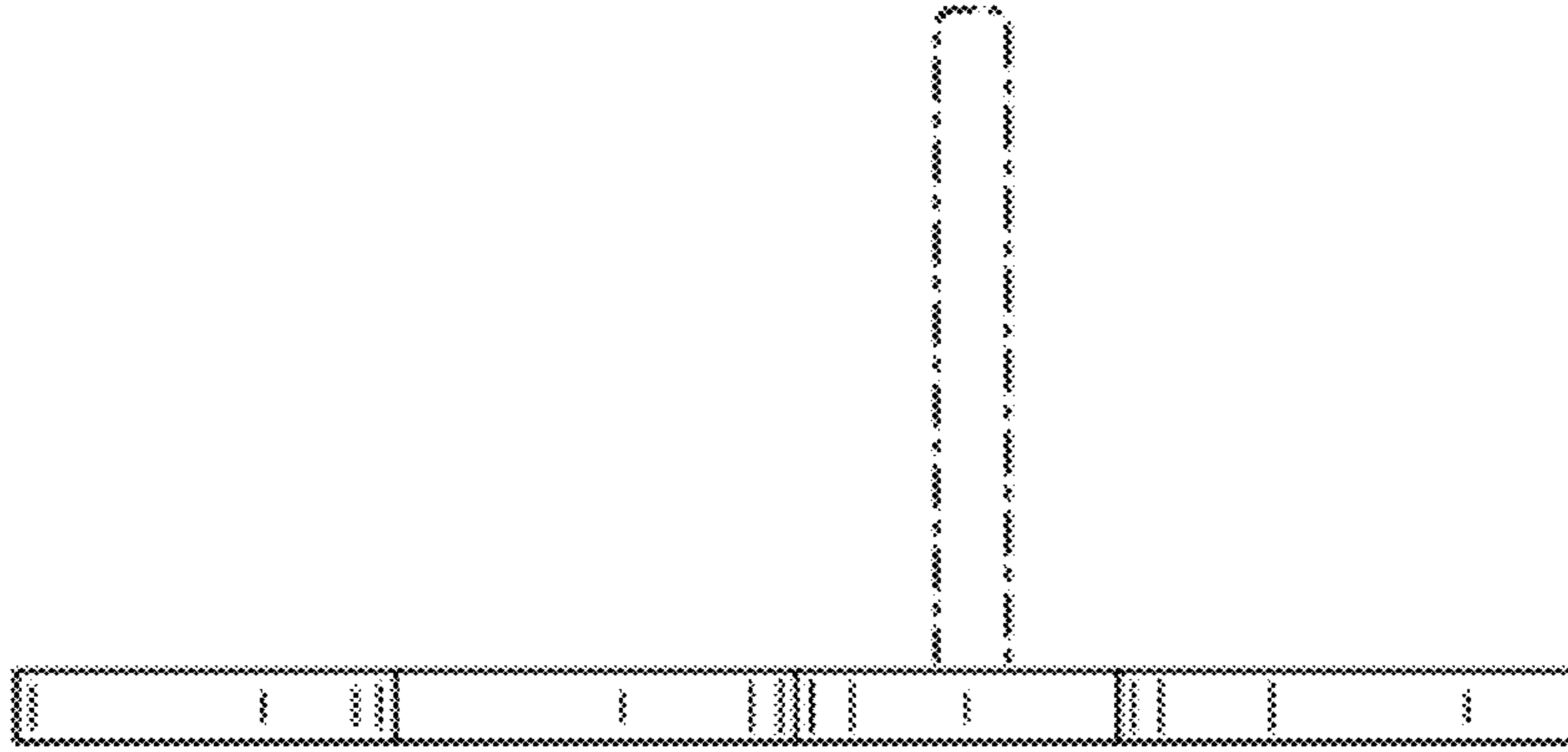

FIG. 4

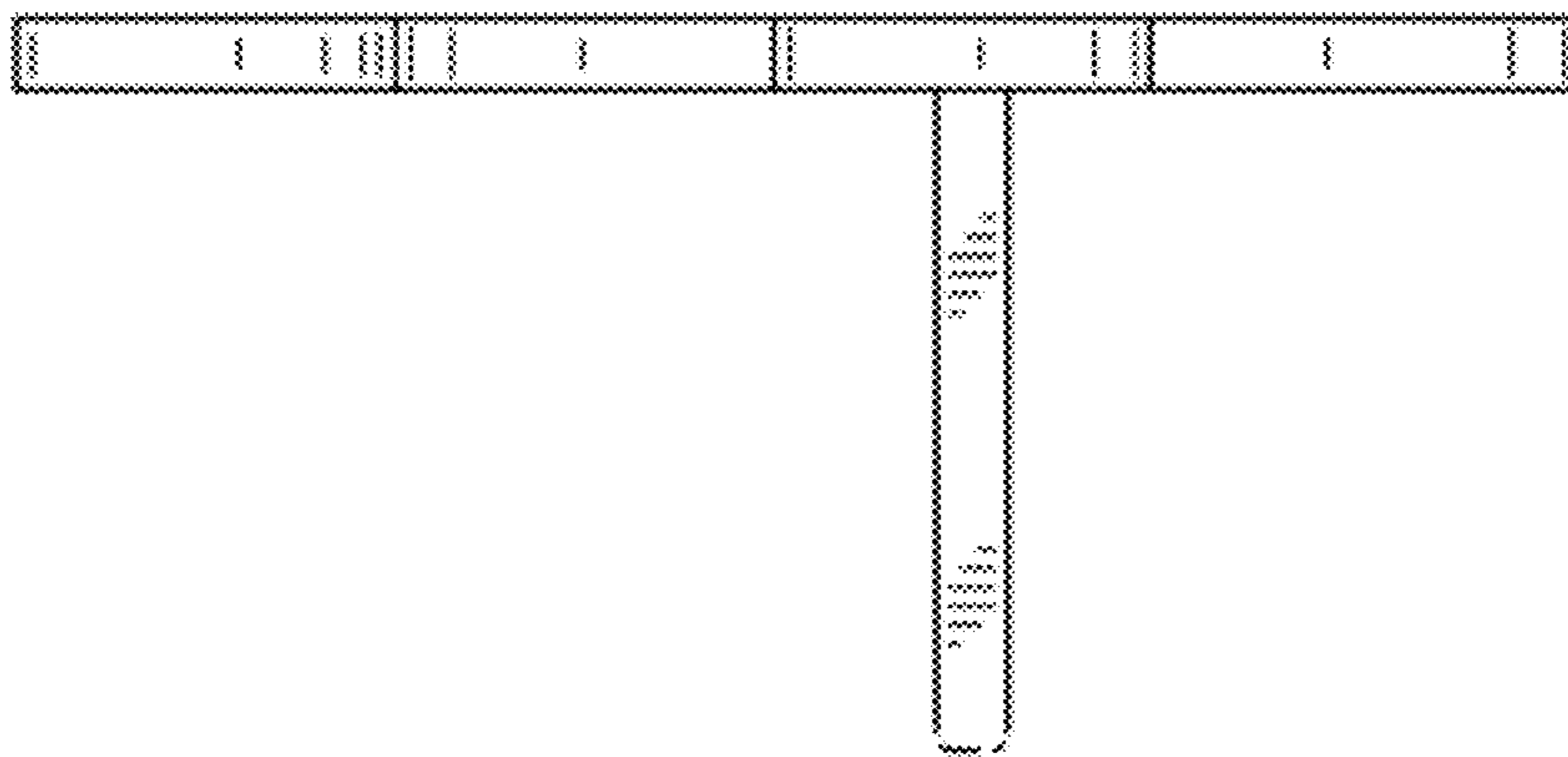

FIG. 3

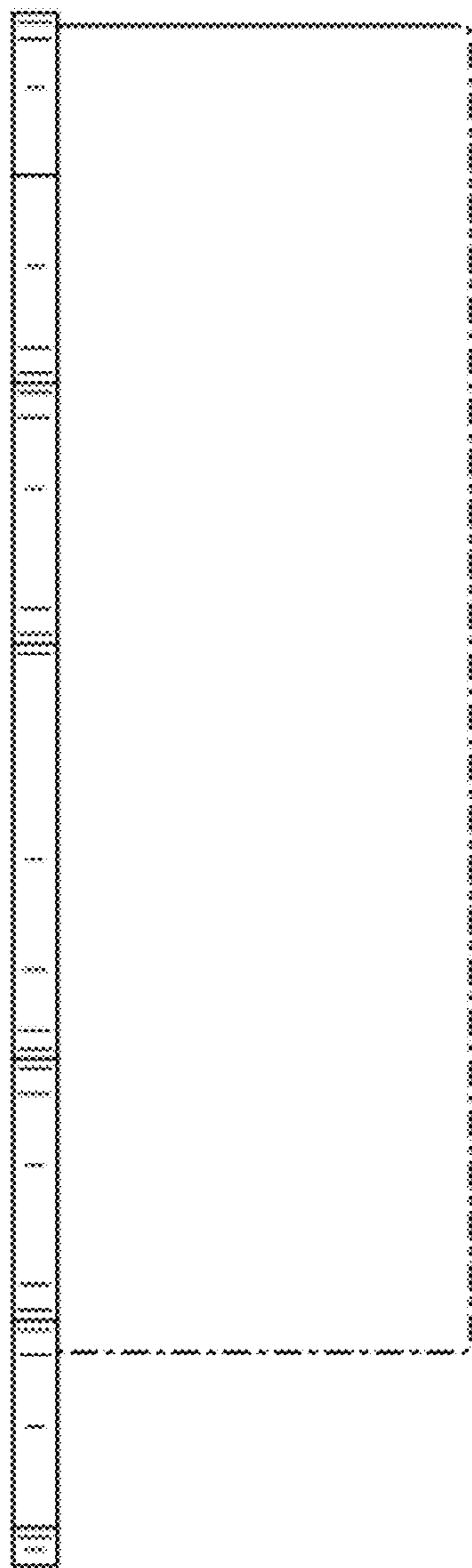

FIG. 5

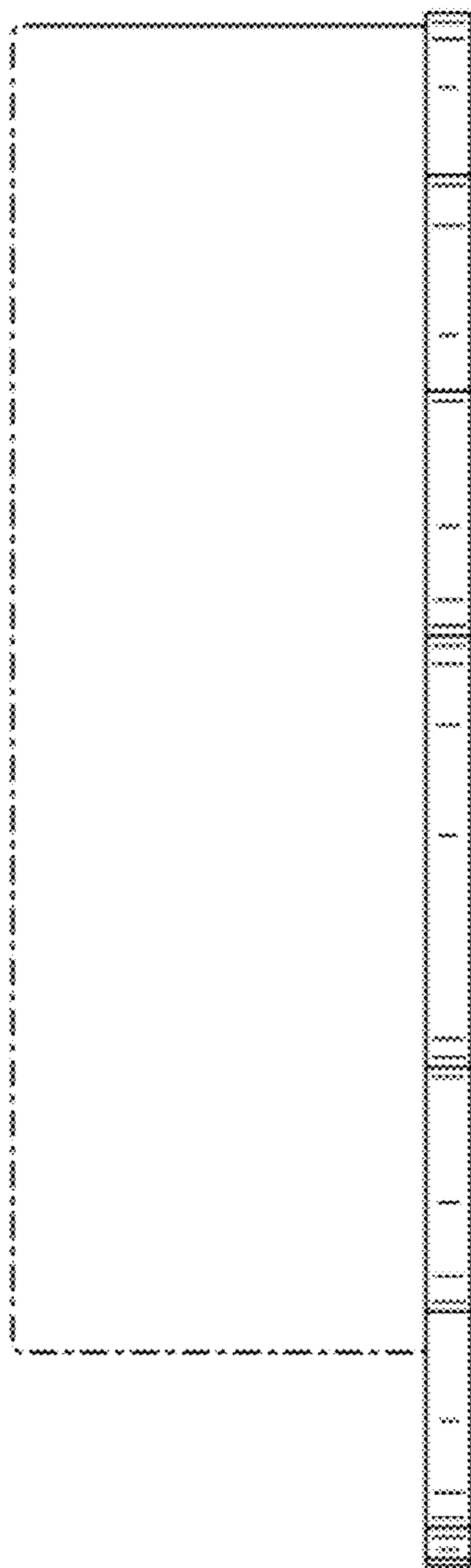

FIG. 6

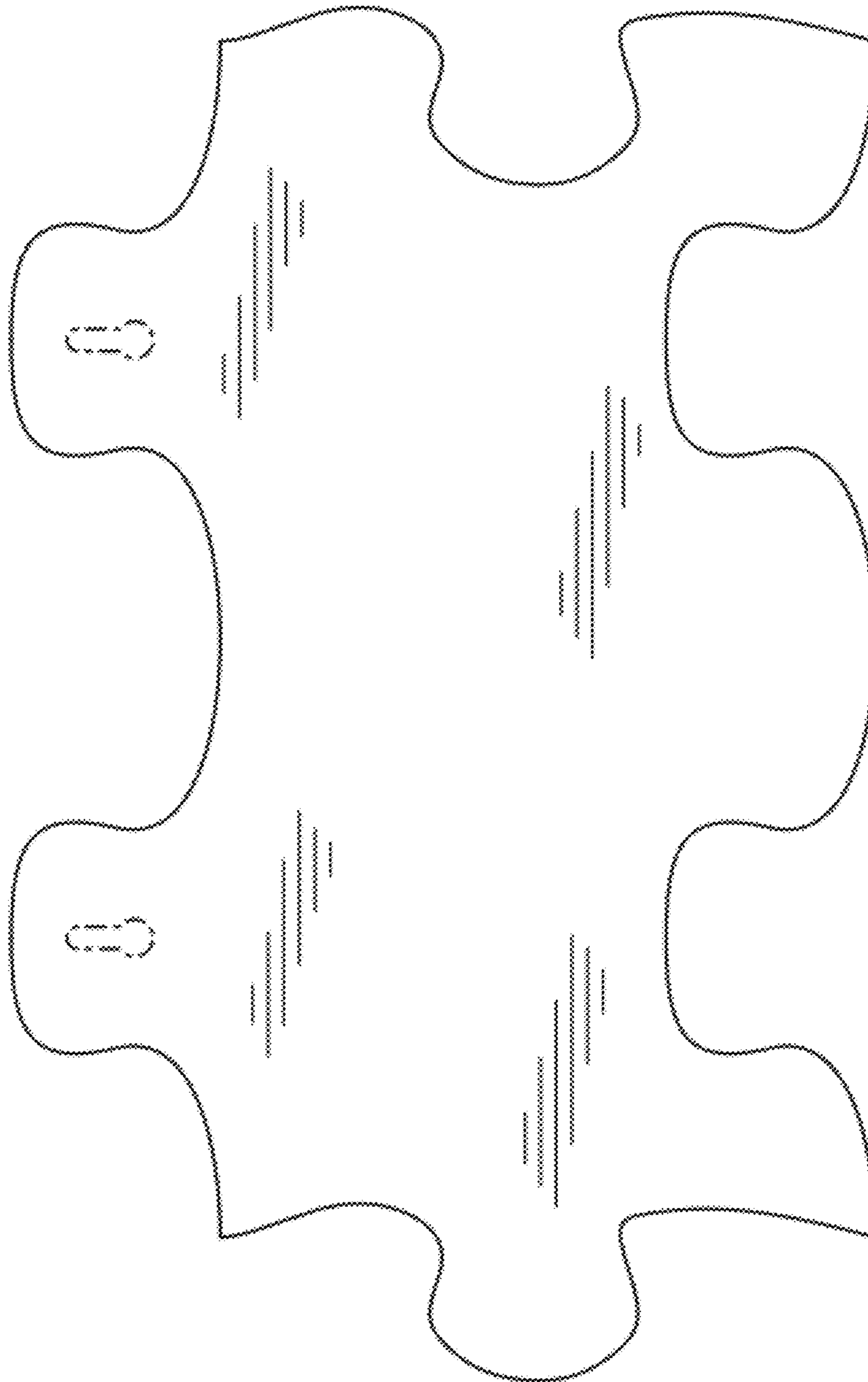

FIG. 7

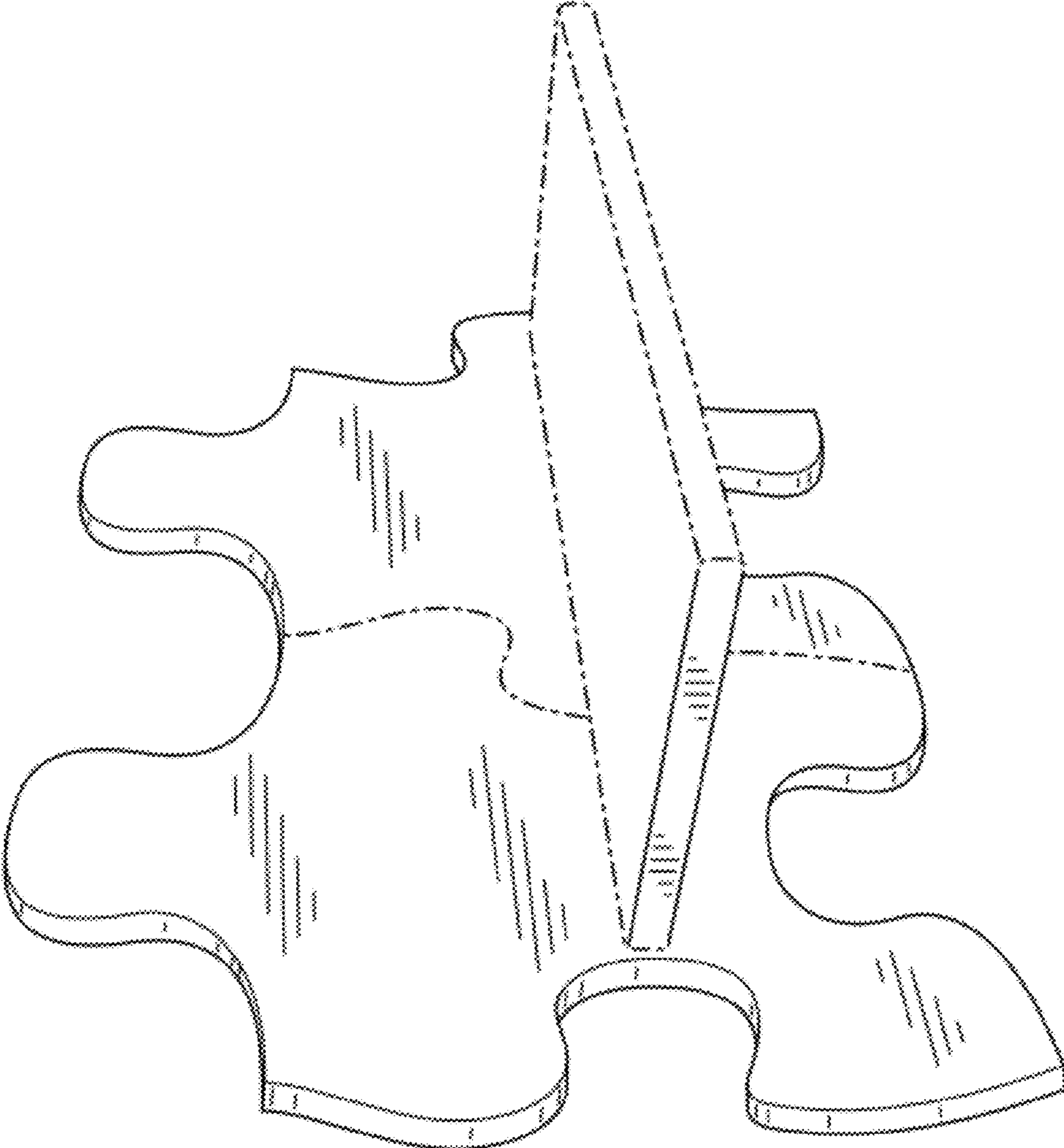

FIG. 8

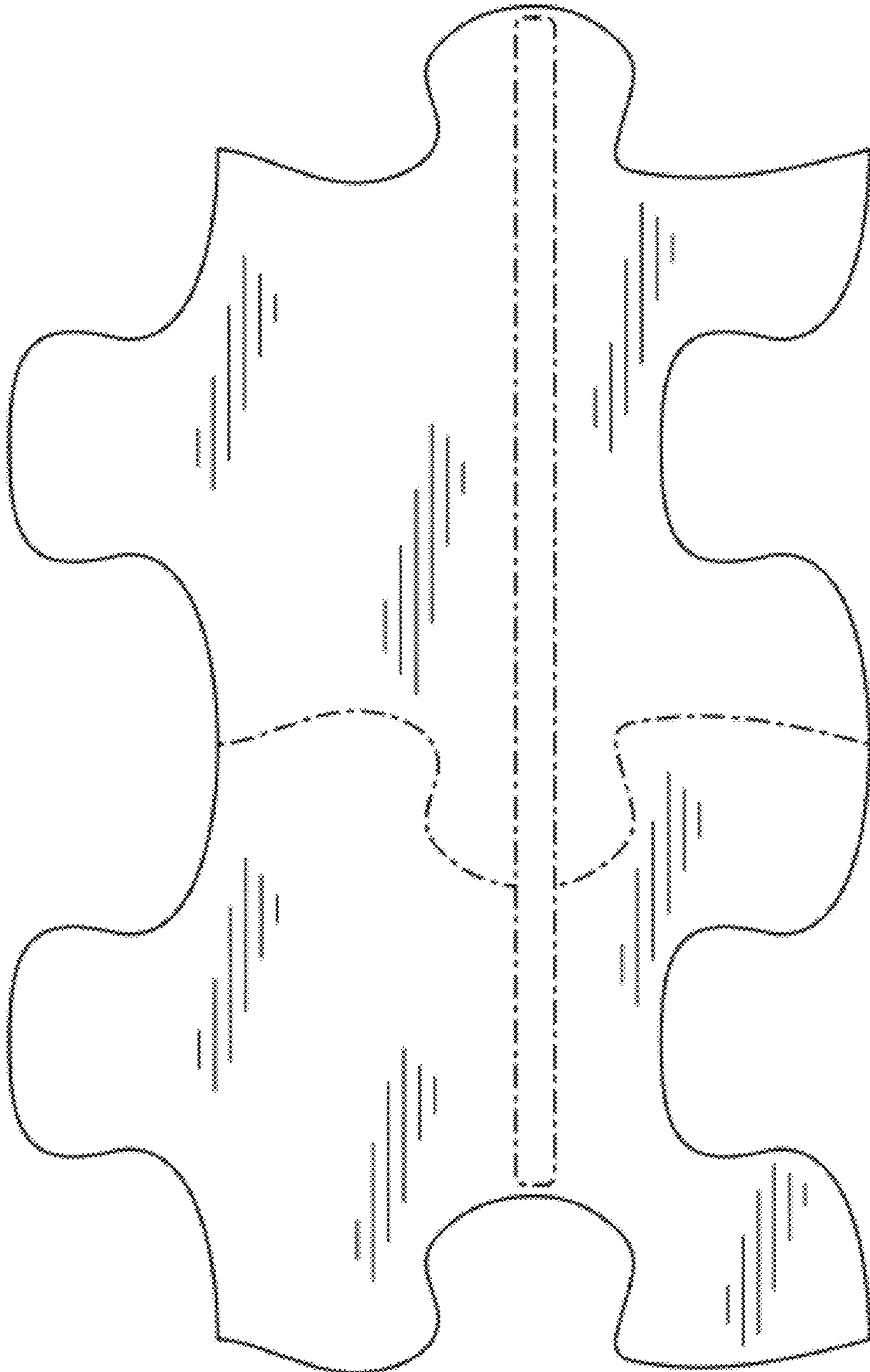

FIG. 9

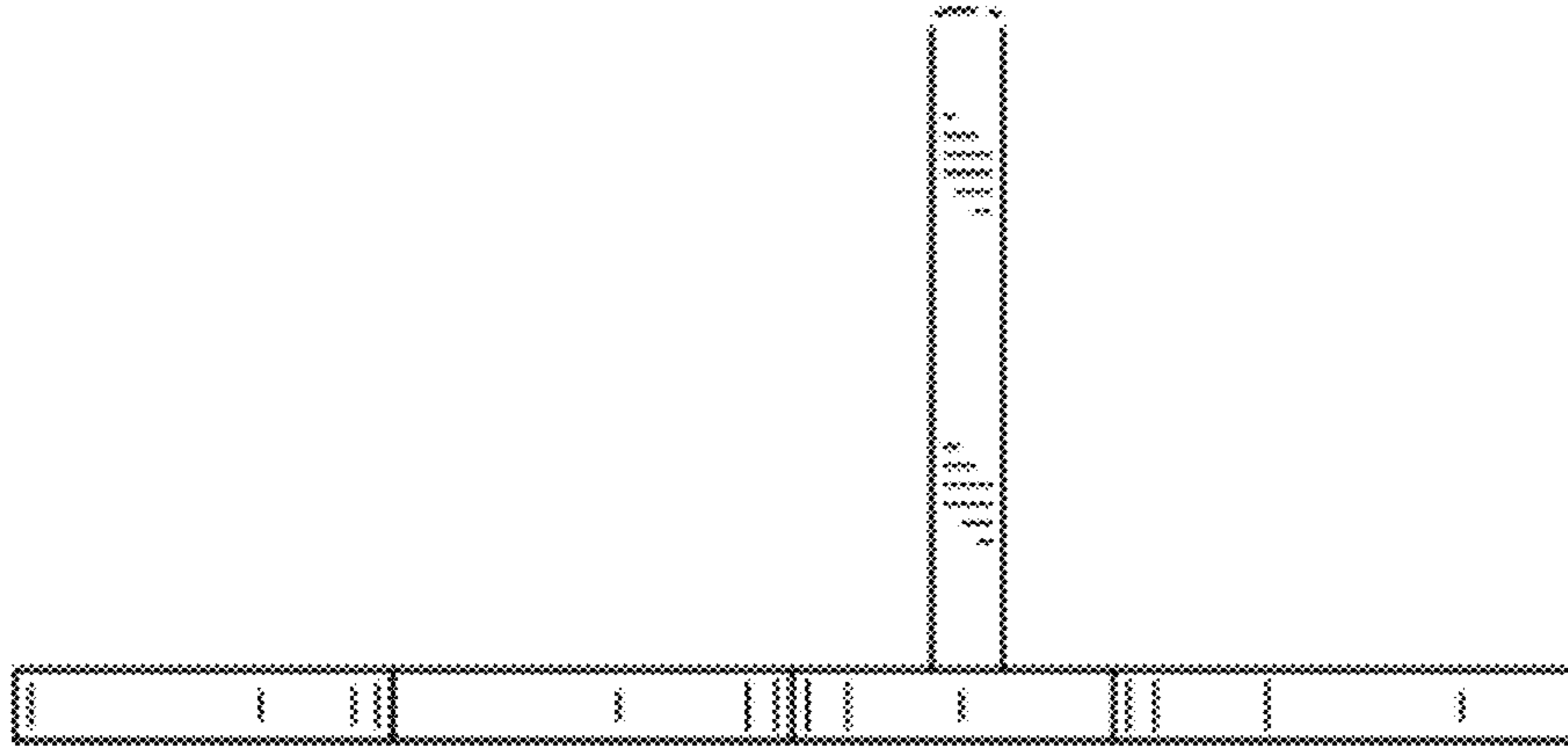

FIG. 11

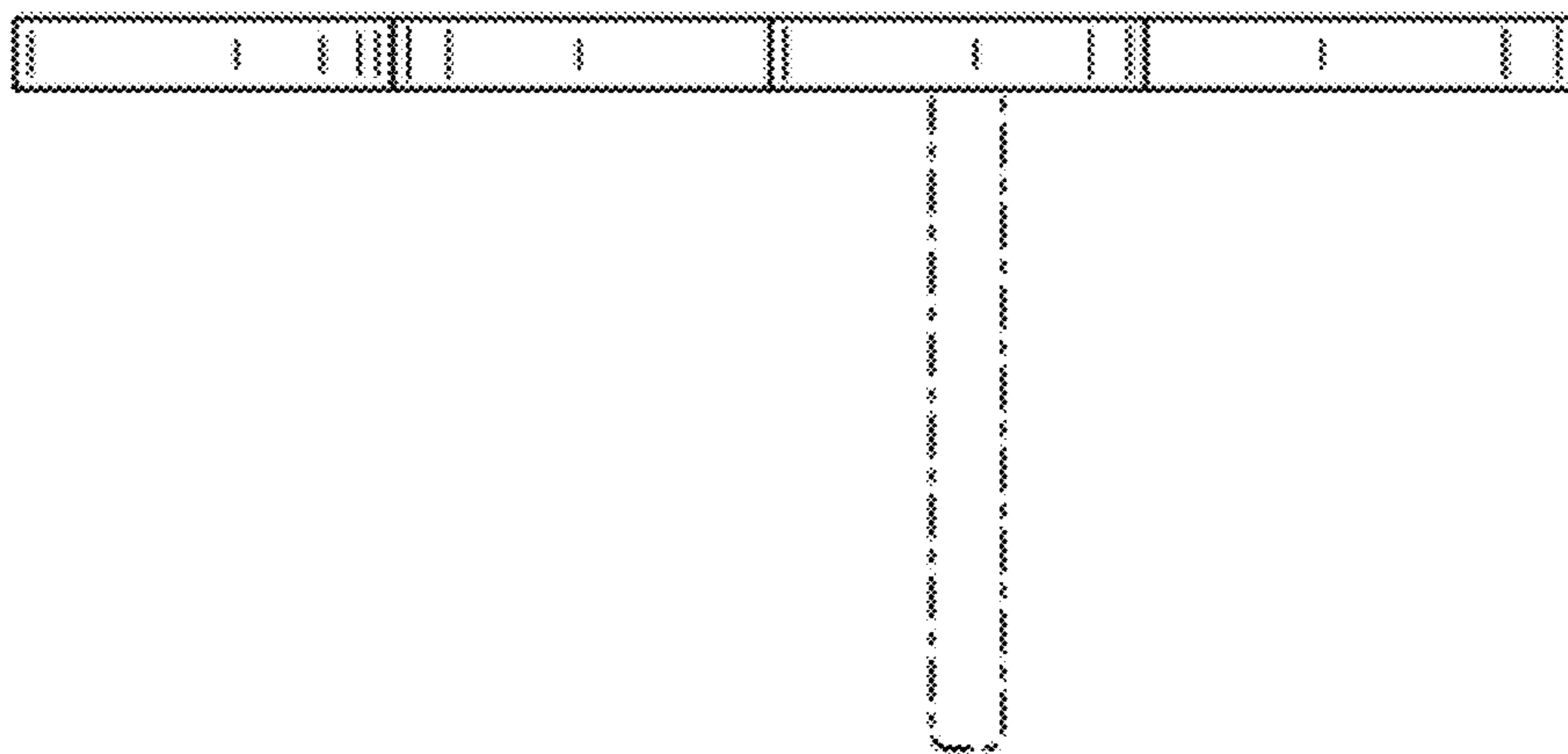

FIG. 10

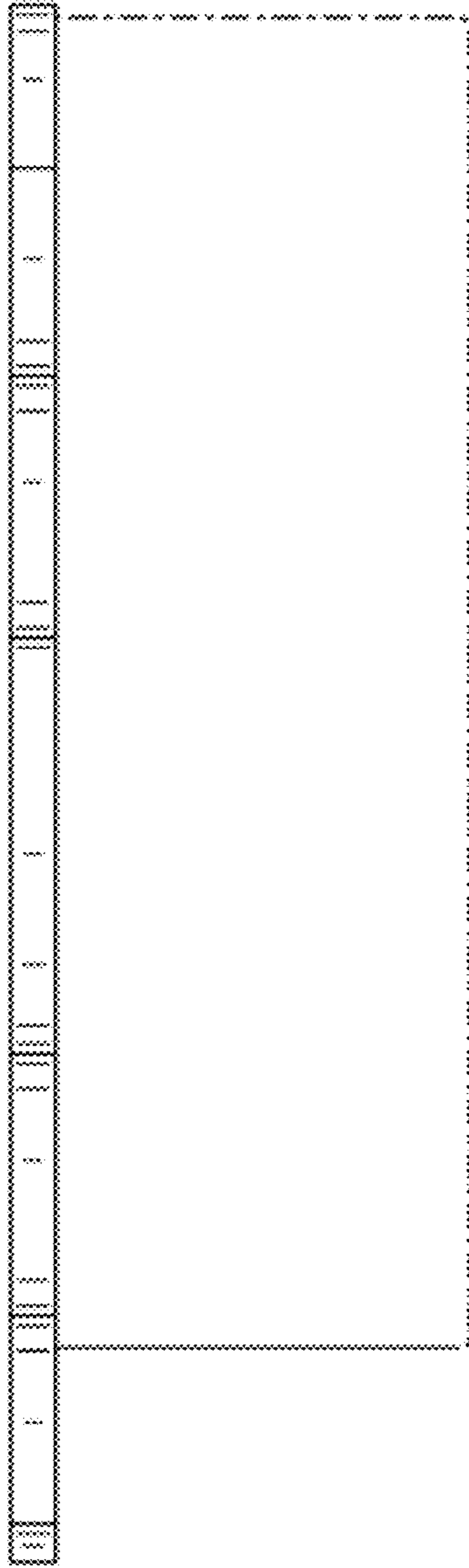

FIG. 12

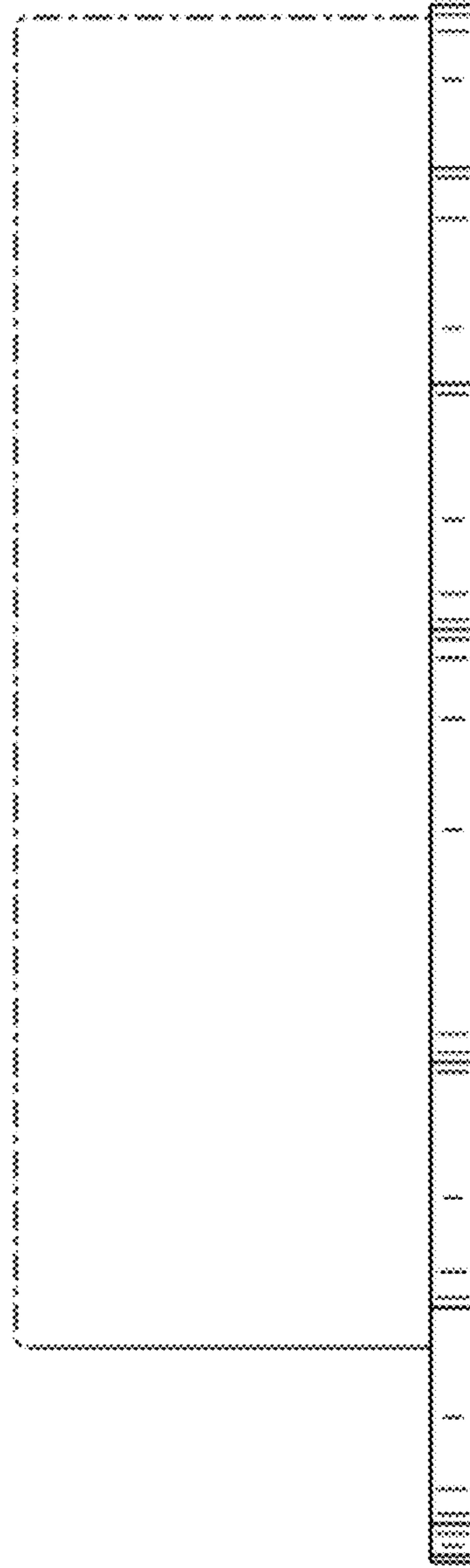

FIG. 13

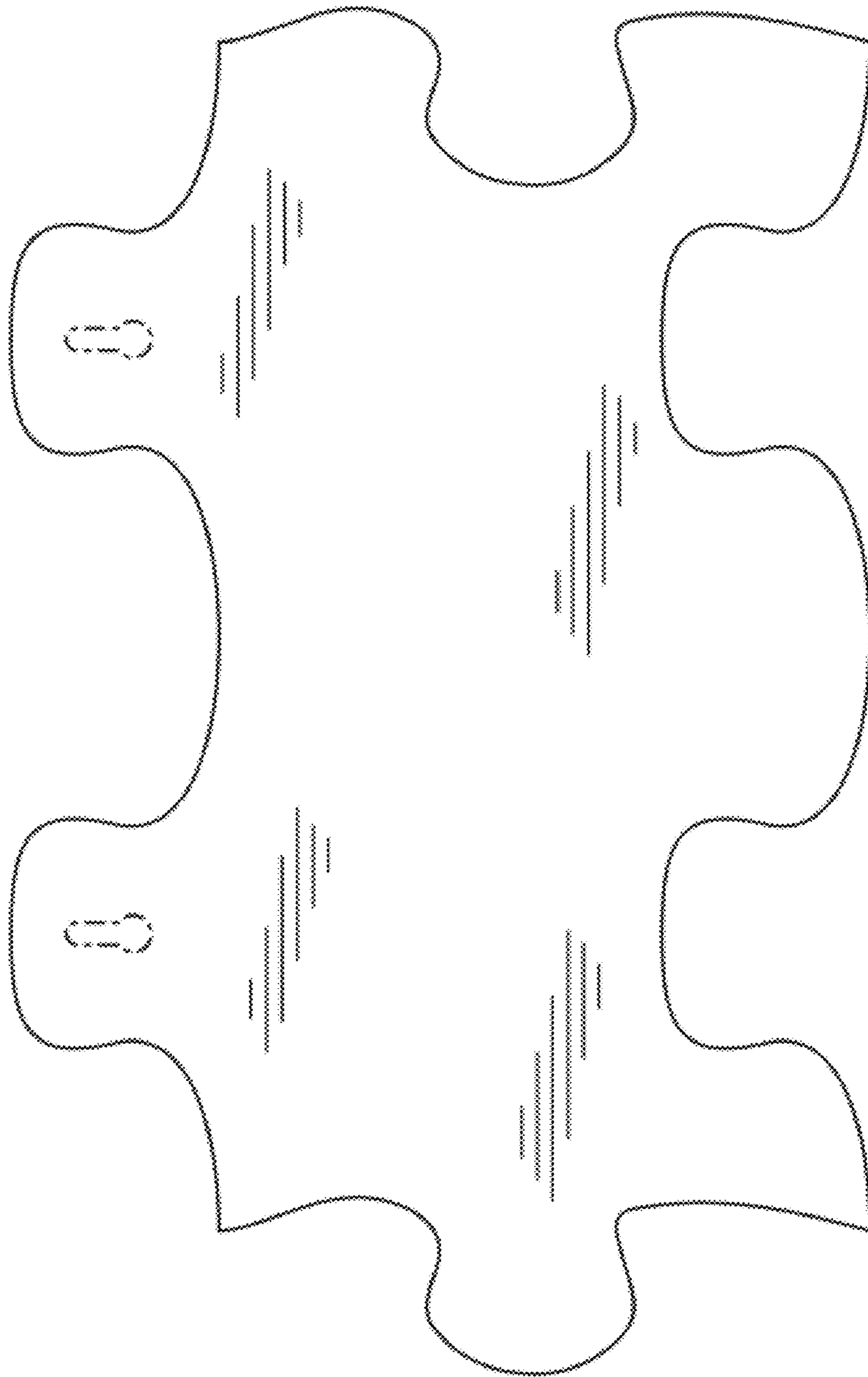

FIG. 14