

US00D666434S

(12) **United States Design Patent**
Grosser

(10) **Patent No.:** **US D666,434 S**
(45) **Date of Patent:** **** Sep. 4, 2012**

(54) **FURNITURE LEG**
(75) Inventor: **Cory Grosser**, Pasadena, CA (US)
(73) Assignee: **Steelcase Inc.**, Grand Rapids, MI (US)
(**) Term: **14 Years**
(21) Appl. No.: **29/390,335**
(22) Filed: **Apr. 22, 2011**
(51) **LOC (9) Cl.** **06-06**
(52) **U.S. Cl.** **D6/495**
(58) **Field of Classification Search** D6/480-489,
D6/495-499, 491, 445, 446, 432, 436; 108/150,
108/153.1, 156, 157.1, 161; 248/188, 188.1,
248/188.7, 188.8
See application file for complete search history.

4,860,667 A 8/1989 Cardenas et al.
D303,885 S 10/1989 Goetz
D305,842 S 2/1990 Herr
D312,736 S 12/1990 Grosfillex
D316,348 S 4/1991 Livi
D318,389 S 7/1991 Hawkinson
D327,592 S 7/1992 Kerem
D327,999 S 7/1992 Grosfillex
D330,132 S 10/1992 Shields
D334,312 S 3/1993 Glass
D335,053 S 4/1993 Morin

(Continued)

OTHER PUBLICATIONS

Coalesse. "Timeless Transitional—Passerelle Collection". Copyright USA_Studio B, 2002.

(Continued)

Primary Examiner — Janice Seeger

(74) *Attorney, Agent, or Firm* — Quarles & Brady LLP

(56) **References Cited**

U.S. PATENT DOCUMENTS

1,051,967 A 2/1913 Person
1,646,175 A 10/1927 Thiede
D168,167 S 6/1952 Molla
D188,900 S 9/1960 Knoll
D215,858 S 11/1969 Hamilton et al.
D223,538 S 5/1972 Manning
D231,886 S 6/1974 Kephart
3,885,765 A 5/1975 Richards
3,912,210 A * 10/1975 von Bohr 248/188.1
D243,376 S 2/1977 Scott
D245,135 S 7/1977 Saltz
D252,431 S 7/1979 Pfister
D256,532 S 8/1980 Aulenti
D259,602 S 6/1981 Mioni
D264,291 S 5/1982 Haigh
D271,551 S 11/1983 Rausch
D278,774 S 5/1985 Fuccio
D282,799 S 3/1986 Doezema
D293,051 S 12/1987 Lemmeyer et al.
D294,318 S 2/1988 Zapf
D299,893 S 2/1989 Diehl

(57) **CLAIM**

The ornamental design for a furniture leg, as shown and described.

DESCRIPTION

FIG. 1 is a right, top, front perspective view of a furniture leg according to my new design shown with additional furniture environment in broken lines;
FIG. 2 is an enlarged right, top, front perspective view thereof shown without the furniture environment shown in FIG. 1;
FIG. 3 is a top, rear perspective view from the left side thereof;
FIG. 4 is a top, front perspective view thereof;
FIG. 5 is a left side elevational view thereof; and,
FIG. 6 is a top plan view thereof.
The broken line representations in the figures are for the purpose of illustrating unclaimed boundaries and/or environment. The broken lines are thus not part of the claim.

1 Claim, 4 Drawing Sheets

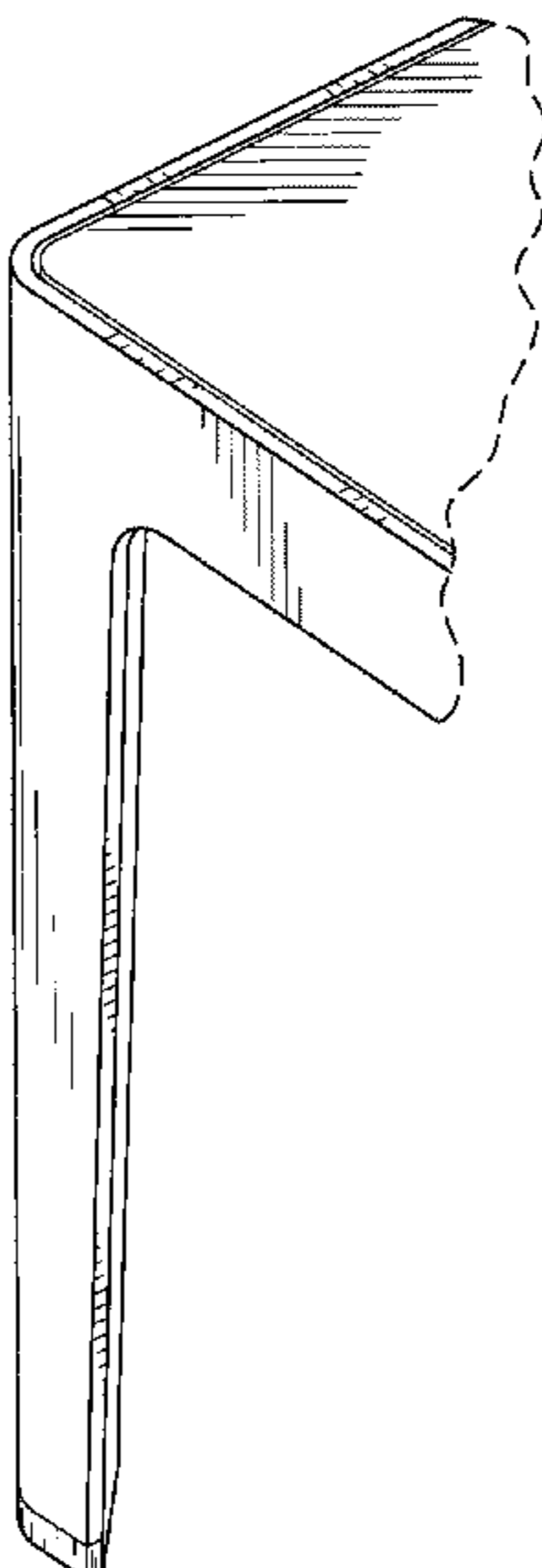

US D666,434 S

Page 2

U.S. PATENT DOCUMENTS

D335,980 S 6/1993 Grosfillex
D340,301 S 10/1993 Evans et al.
D343,312 S 1/1994 Burdick et al.
D346,704 S * 5/1994 Grosfillex D6/349
D350,865 S 9/1994 Ward
D355,315 S 2/1995 Walters
D355,316 S 2/1995 Kellen
D357,374 S 4/1995 Rabe
D358,283 S 5/1995 Kelly
D359,406 S 6/1995 Crawford et al.
D363,189 S 10/1995 Griphoff
D367,563 S 3/1996 Murken
D367,977 S 3/1996 Lewis
D369,045 S 4/1996 Mitchell
D372,819 S 8/1996 Maple
D376,499 S 12/1996 Glick et al.
D382,734 S 8/1997 Hartman, Sr.
D389,346 S 1/1998 Schefcik
D391,422 S 3/1998 Lewis
D395,771 S 7/1998 Kelly et al.
D407,245 S 3/1999 Lewis
D412,255 S 7/1999 Lewis
D415,370 S 10/1999 Zarker, Jr.
D424,841 S 5/2000 Newhouse
D425,335 S 5/2000 Newhouse
D427,811 S 7/2000 Ismail
D433,849 S 11/2000 Walters, III et al.
D445,609 S 7/2001 Jeup
D448,216 S 9/2001 Kolberg
D449,946 S 11/2001 Hokanson
D450,495 S 11/2001 Plavsic
D453,083 S 1/2002 Hokanson
D455,277 S 4/2002 Hutton
D468,938 S 1/2003 Williams
D472,408 S 4/2003 Carroll, III

D476,175 S 6/2003 Jackson
D484,717 S 1/2004 de Blois
D486,329 S 2/2004 Strong
D487,654 S 3/2004 Molteni
D489,926 S 5/2004 Lemmeyer
D493,983 S 8/2004 Guglielmo et al.
D498,949 S 11/2004 Frenkler et al.
D501,103 S 1/2005 Ashby et al.
D503,298 S 3/2005 Juneau
D508,625 S 8/2005 Frenkler et al.
D509,384 S 9/2005 Suzuki et al.
D513,909 S 1/2006 Bibi
D522,279 S 6/2006 Hansbaek
D540,570 S 4/2007 Bibi
D541,559 S 5/2007 Lewis
D551,469 S 9/2007 Bibi
D555,941 S 11/2007 Sorci
D568,639 S 5/2008 Henriott
D573,374 S 7/2008 Vasileiou
D573,384 S 7/2008 Domack
D583,590 S 12/2008 Ellouz
D590,185 S 4/2009 Karashima
D593,342 S 6/2009 Pessa
D611,732 S 3/2010 Hayes
D613,968 S 4/2010 Lambert
D617,122 S 6/2010 Moon et al.
D620,288 S 7/2010 Stiker Metral

OTHER PUBLICATIONS

Blu Dot. "Modern Table—Nick Square". Bludot.com online catalog.
HBF. "Carousel Table". HBF.com online catalog.
Vitra. "Plate Table". Vitra.com online catalog.
Nienkamper. "Virso". Nienkamper.com online catalog.

* cited by examiner

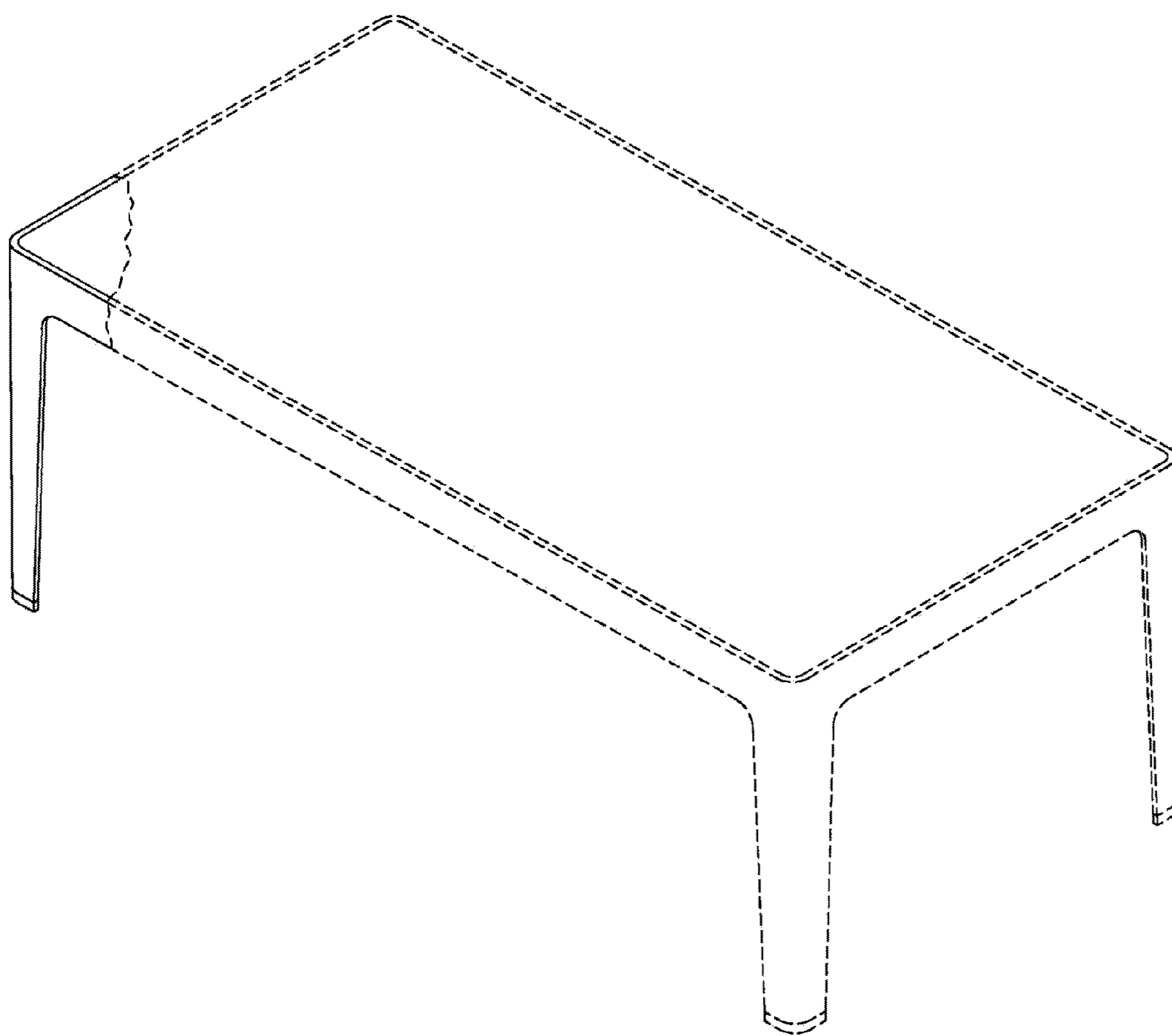

FIG. 1

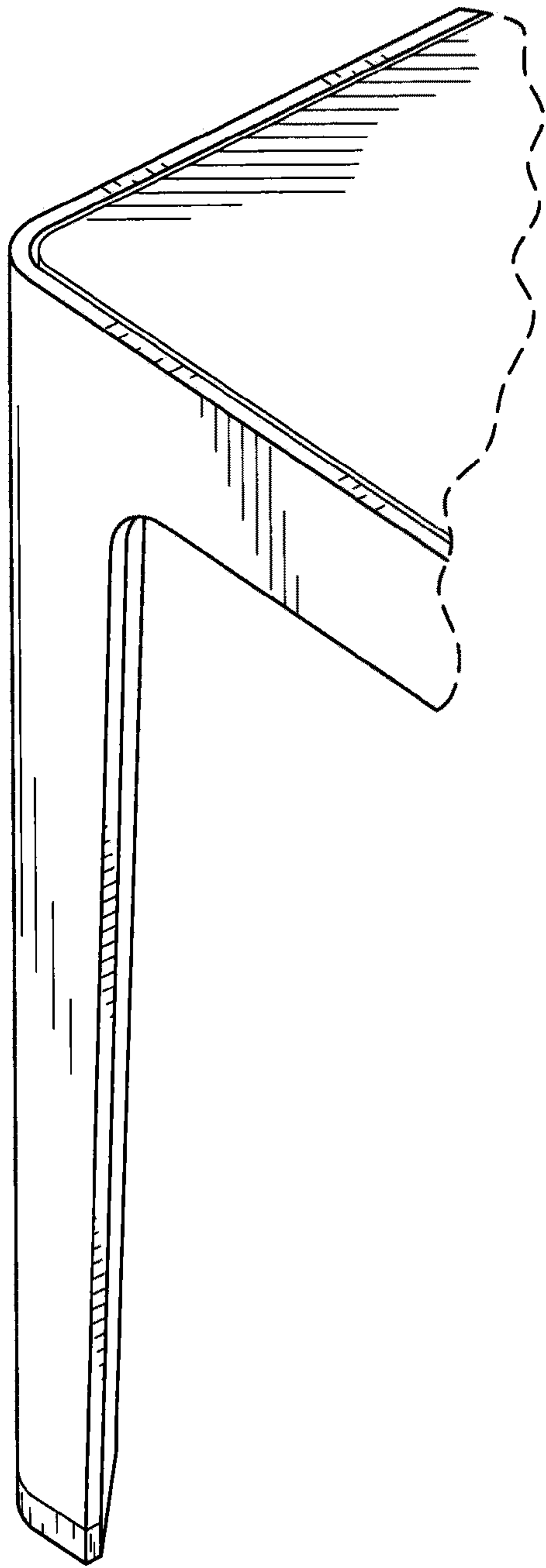

FIG. 2

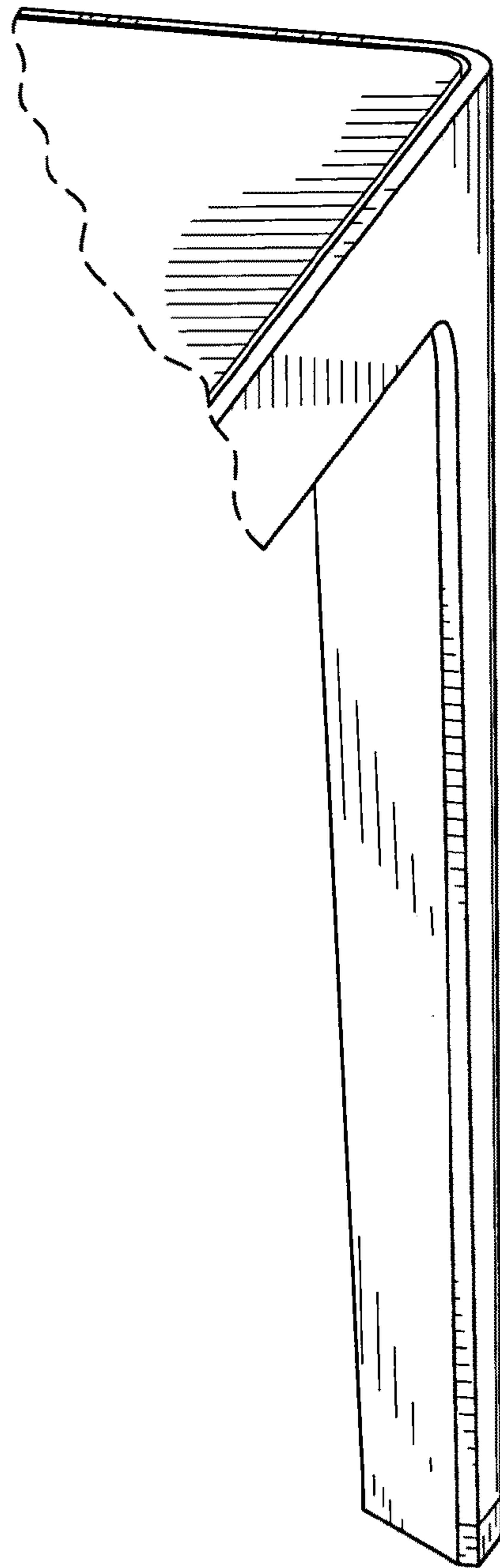

FIG. 3

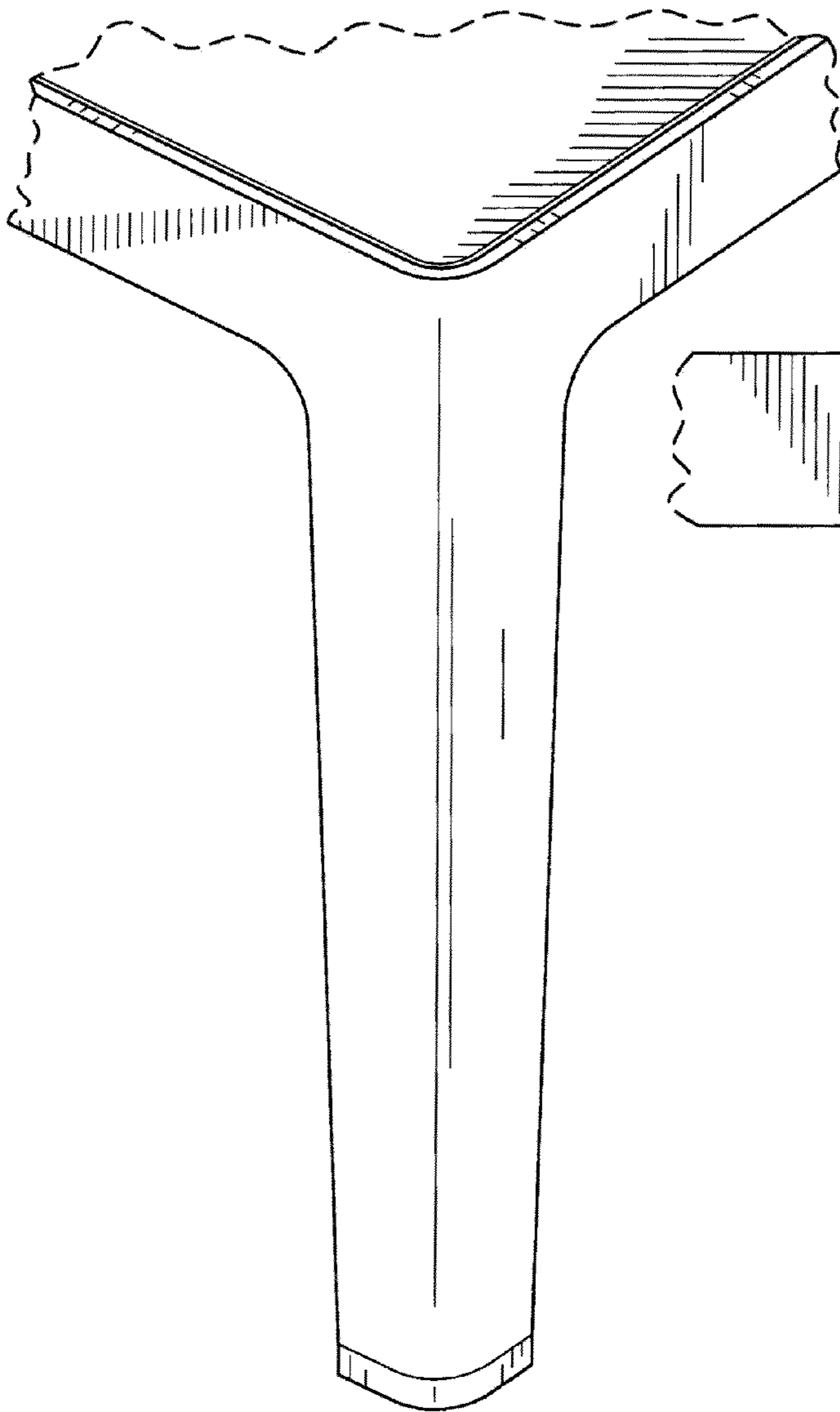

FIG. 4

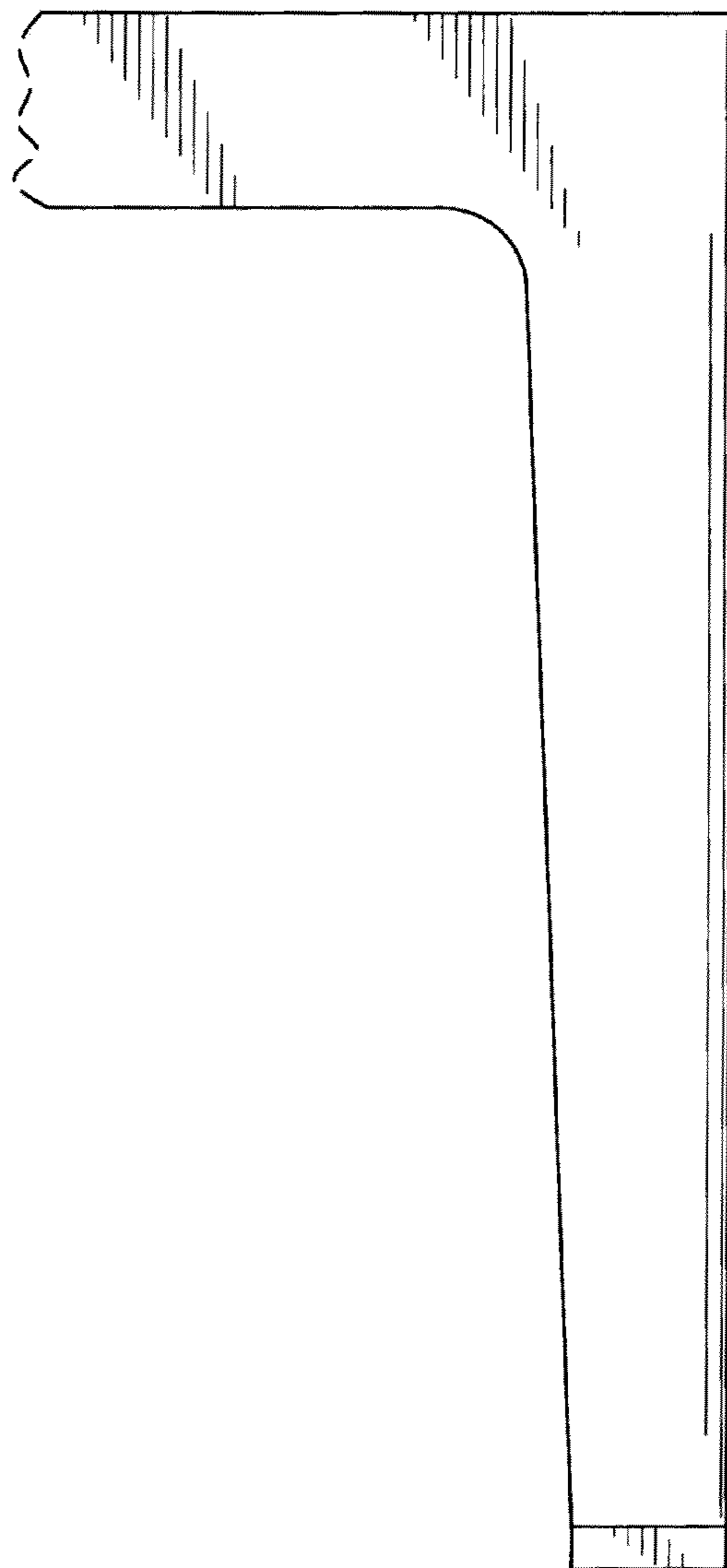

FIG. 5

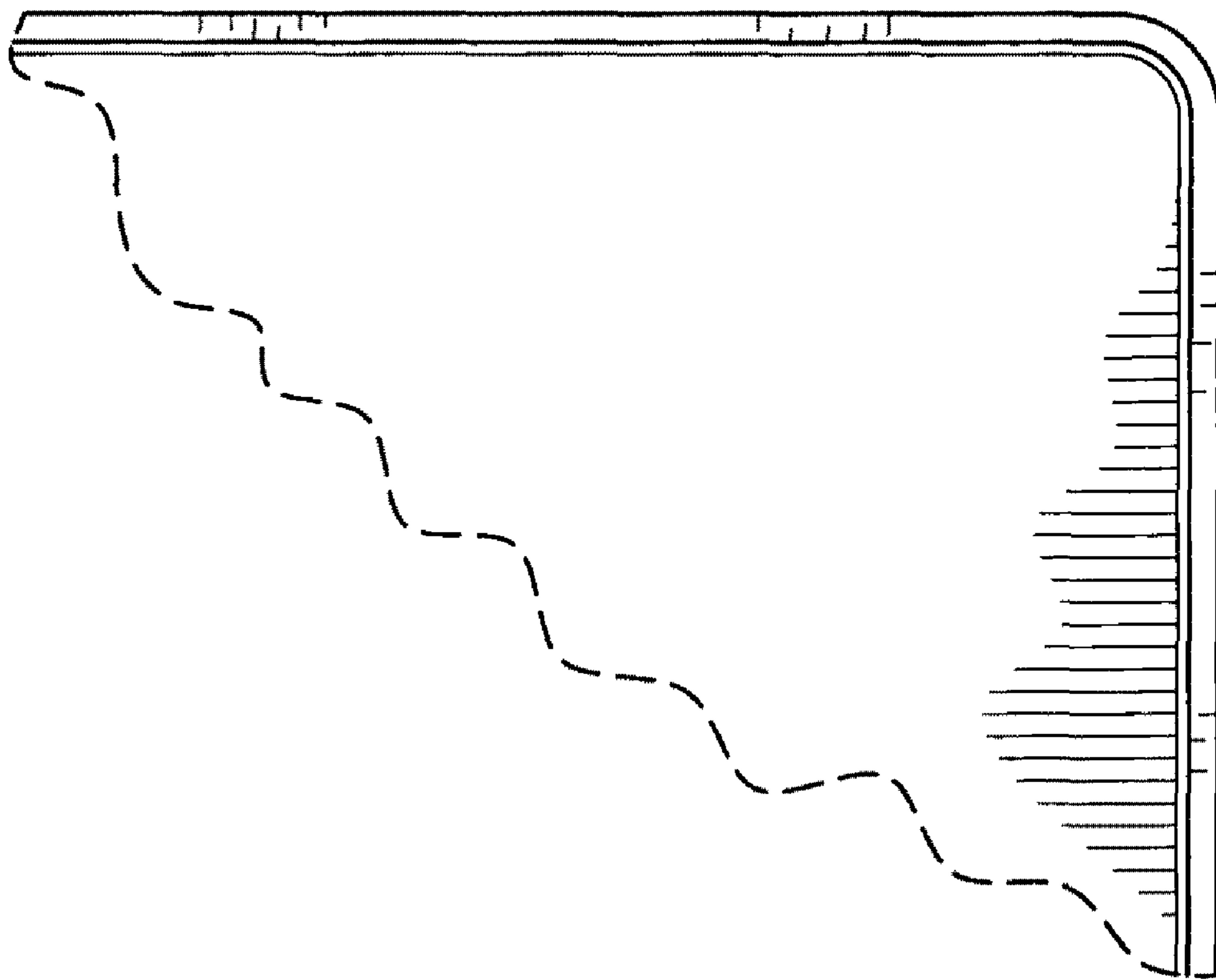

FIG. 6