



US00D666343S

(12) **United States Design Patent**
Lee

(10) **Patent No.:** **US D666,343 S**

(45) **Date of Patent:** **** Aug. 28, 2012**

(54) **CAP LIGHT**

(76) Inventor: **Wen-Sung Lee**, Taichung (TW)

(**) Term: **14 Years**

(21) Appl. No.: **29/400,024**

(22) Filed: **Aug. 23, 2011**

(51) **LOC (9) Cl.** **26-02**

(52) **U.S. Cl.** **D26/39**

(58) **Field of Classification Search** D26/37,
D26/38, 39, 40, 45, 46, 49, 28-30; 362/103,
362/105, 106, 116, 157, 158, 183, 184, 190,
362/194-196, 202-208

See application file for complete search history.

(56) **References Cited**

U.S. PATENT DOCUMENTS

D478,576 S *	8/2003	Leong	D14/240
D498,864 S *	11/2004	Lee	D26/37
D523,573 S *	6/2006	Lee	D26/28
D541,451 S *	4/2007	Leung	D26/38
D547,475 S *	7/2007	Xu	D26/39
D564,111 S *	3/2008	Hillard	D26/39
D566,097 S *	4/2008	Bhavnani	D14/168
D568,509 S *	5/2008	Shiu	D26/39

D570,023 S *	5/2008	Lee	D26/60
D580,573 S *	11/2008	Leslie et al.	D26/37
D590,975 S *	4/2009	Ma	D26/60
D592,340 S *	5/2009	Liao et al.	D26/60
D598,149 S *	8/2009	Leslie et al.	D26/37
D615,227 S *	5/2010	Hine et al.	D26/46

* cited by examiner

Primary Examiner — Ian Simmons

Assistant Examiner — Carissa C Fitts

(57) **CLAIM**

The ornamental design for a cap light, as shown and described.

DESCRIPTION

FIG. 1 is a perspective view of a cap light showing my new design;

FIG. 2 is a front elevational view thereof;

FIG. 3 is a rear elevational view thereof;

FIG. 4 is a left side view thereof;

FIG. 5 is a right side view thereof;

FIG. 6 is a top plan view thereof; and,

FIG. 7 is a bottom plan view thereof.

The broken line showing is for environmental purposes only and forms no part of the claimed design.

1 Claim, 7 Drawing Sheets

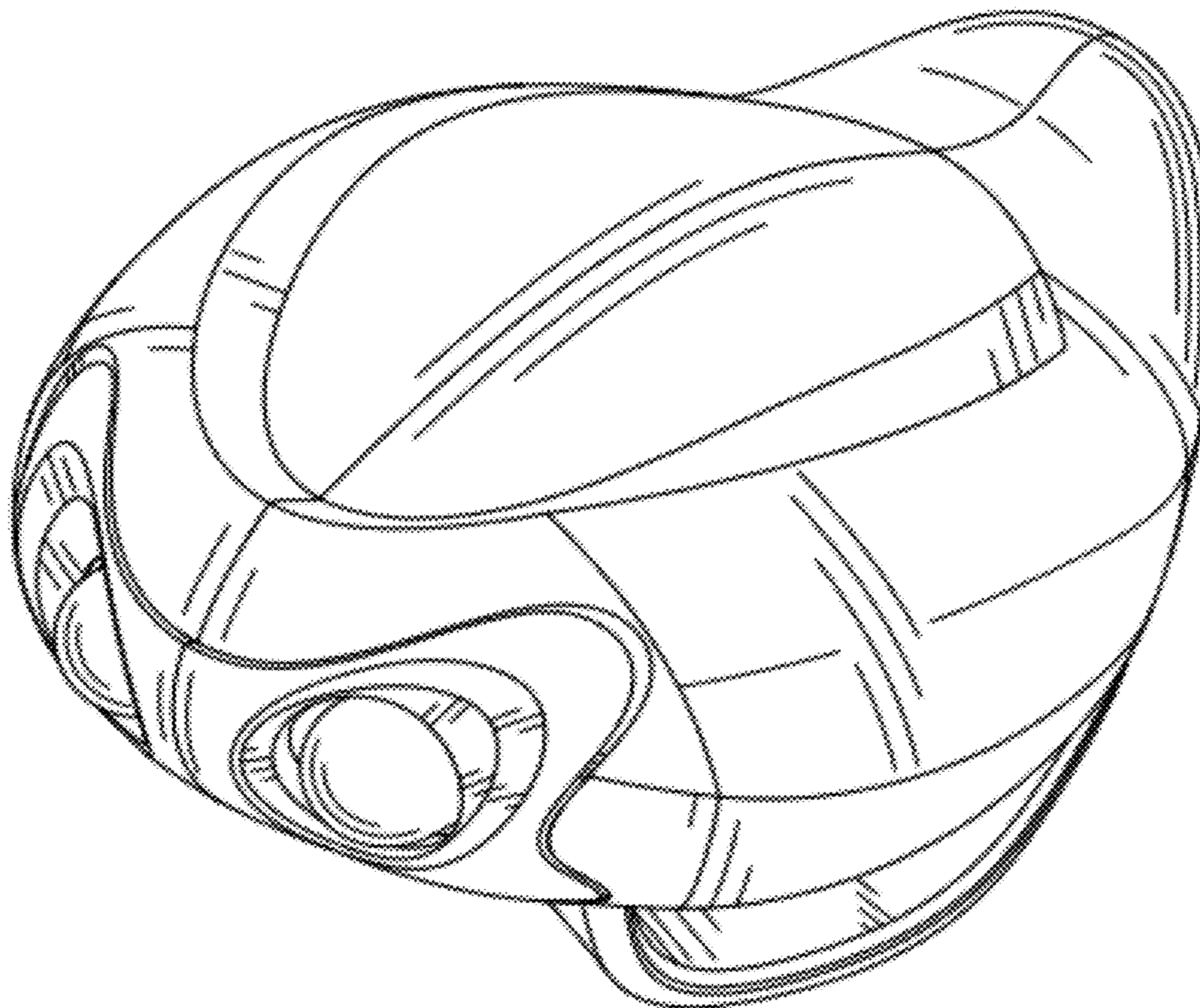

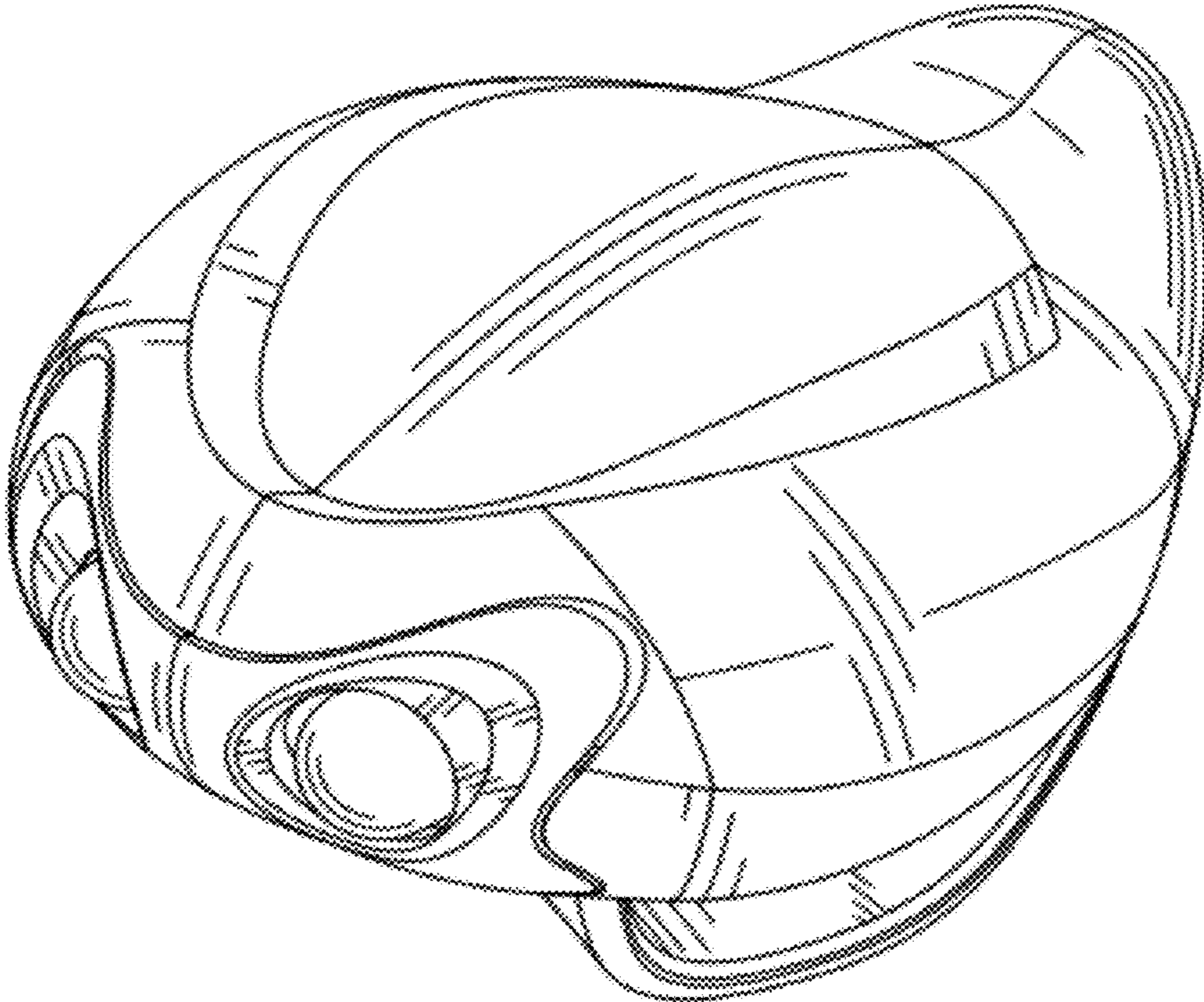

FIG. 1

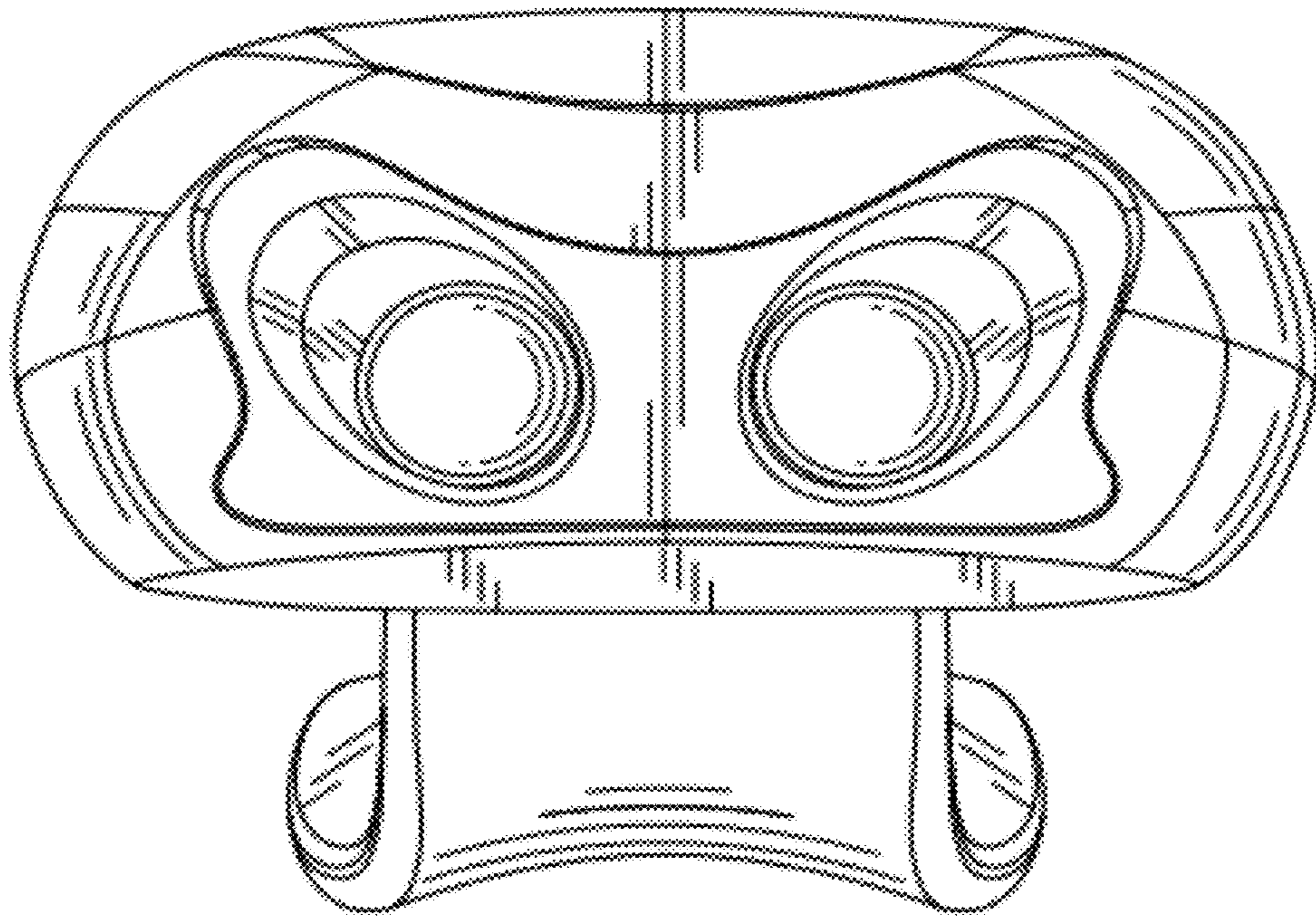

FIG. 2

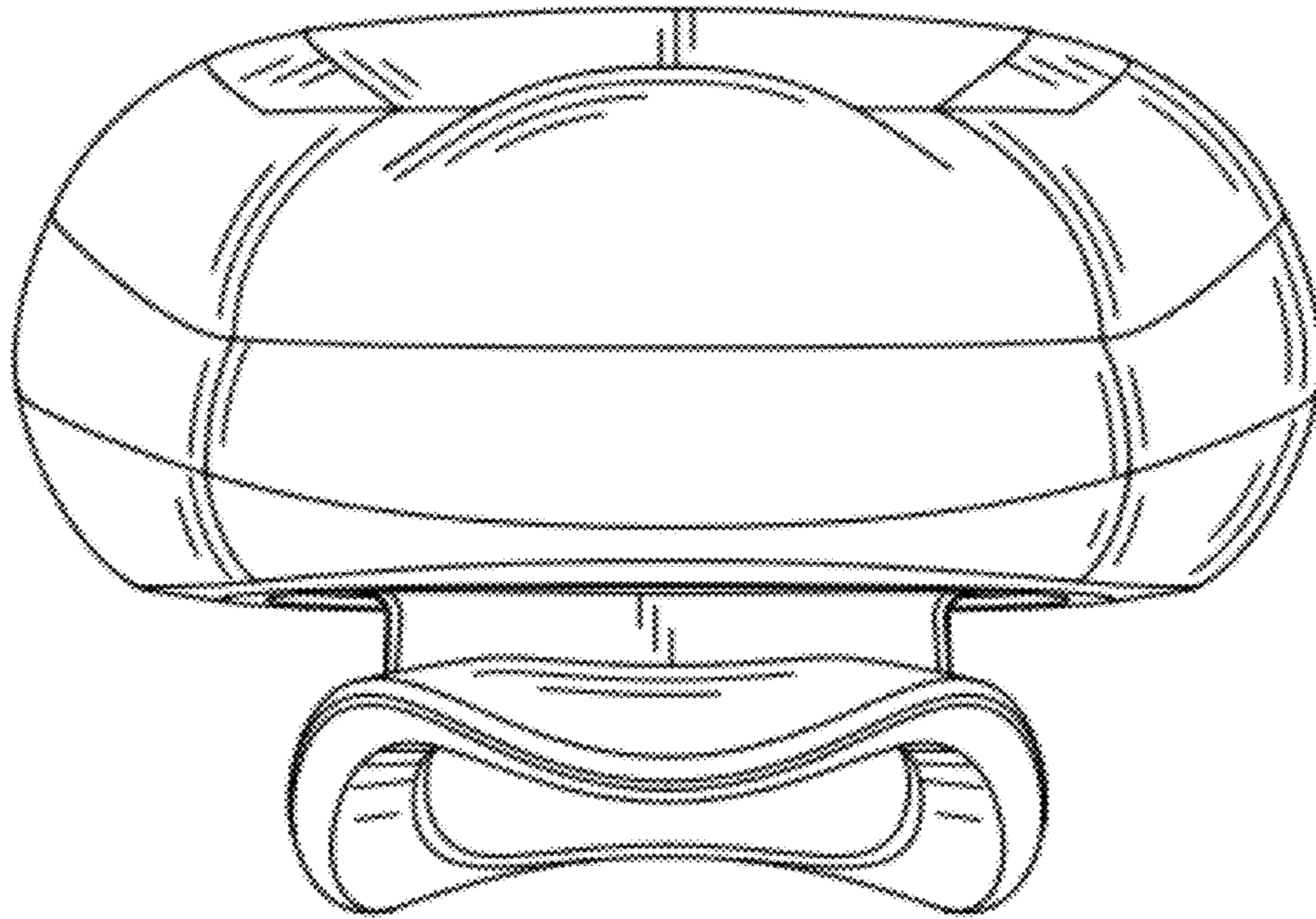

FIG. 3

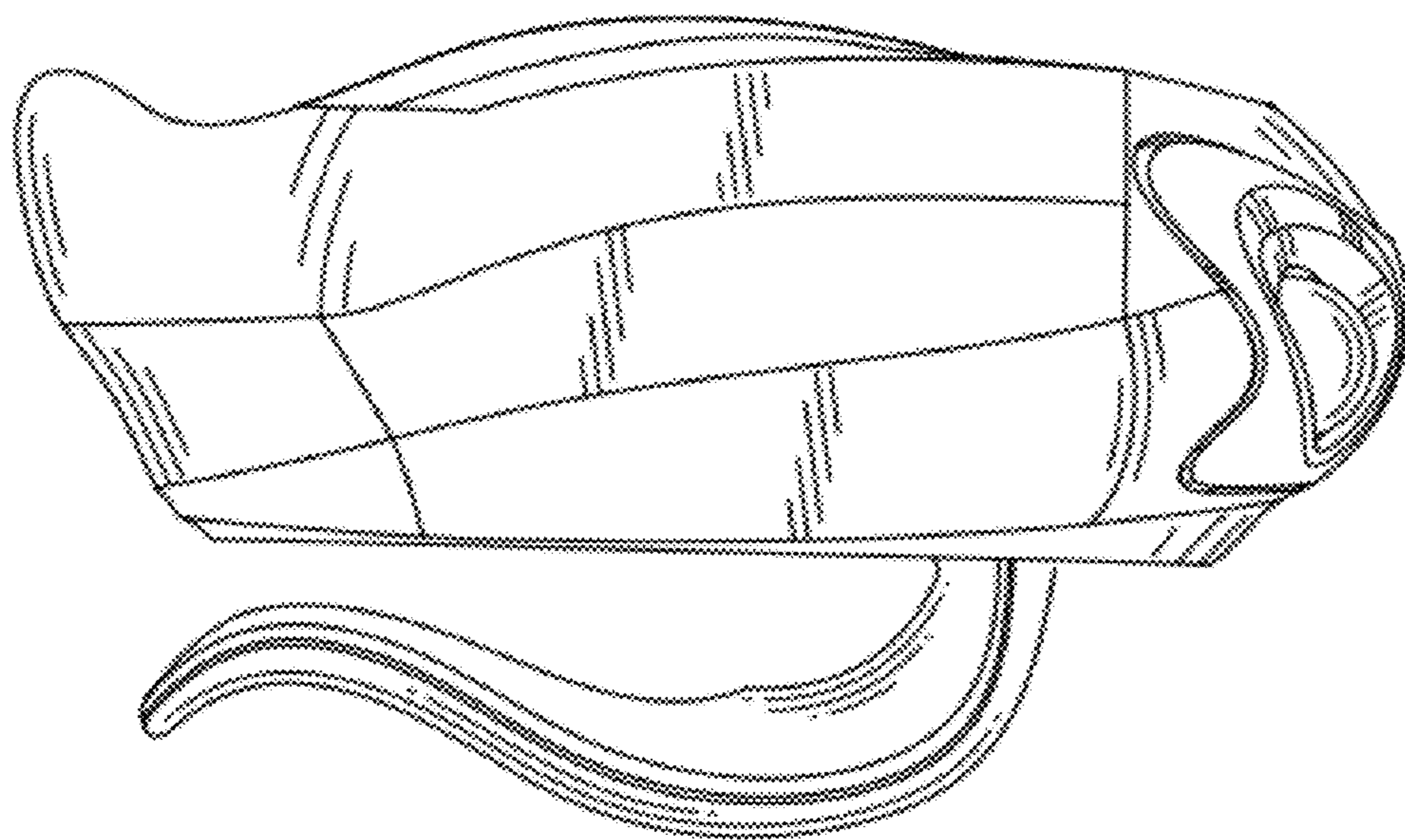

FIG. 4

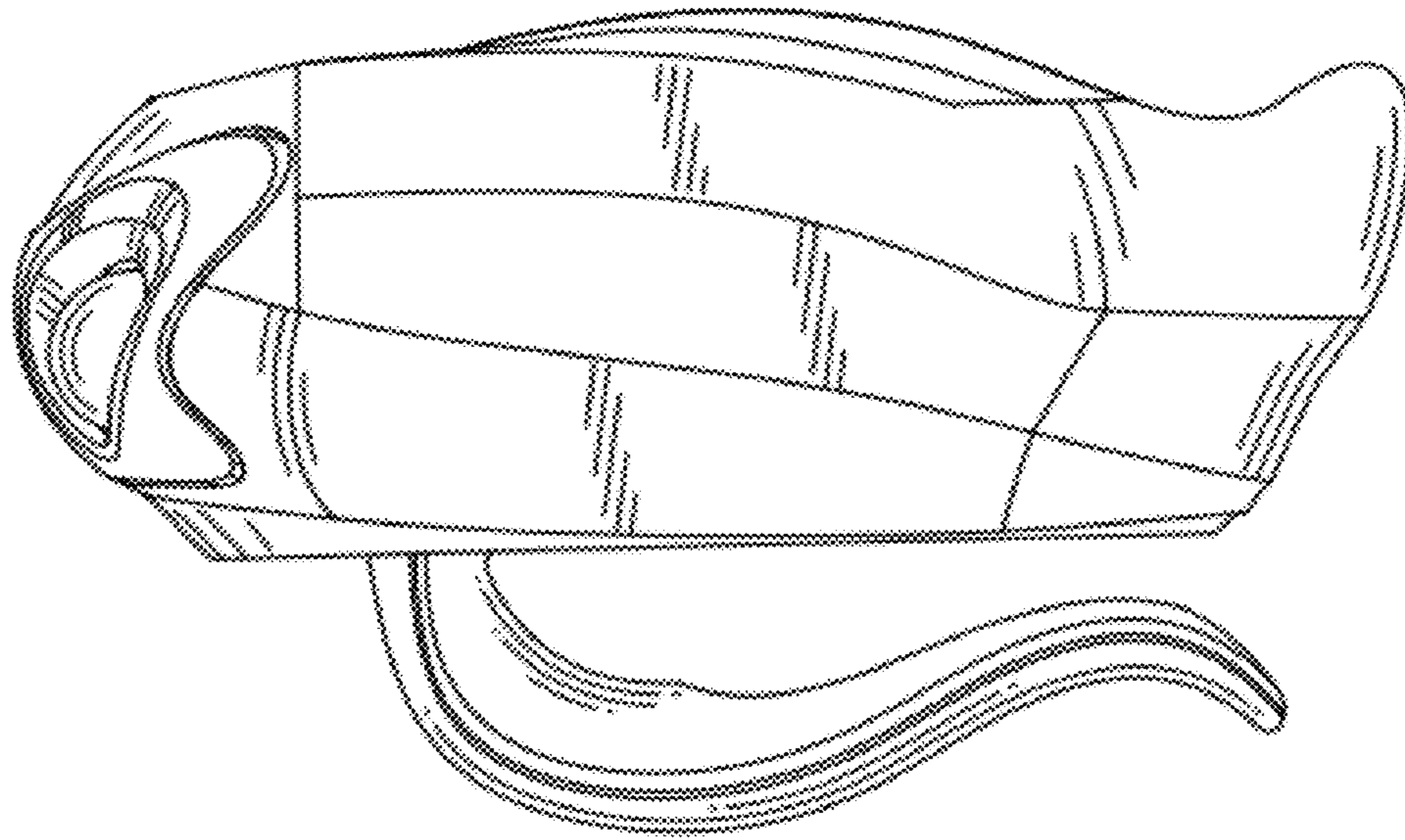

FIG. 5

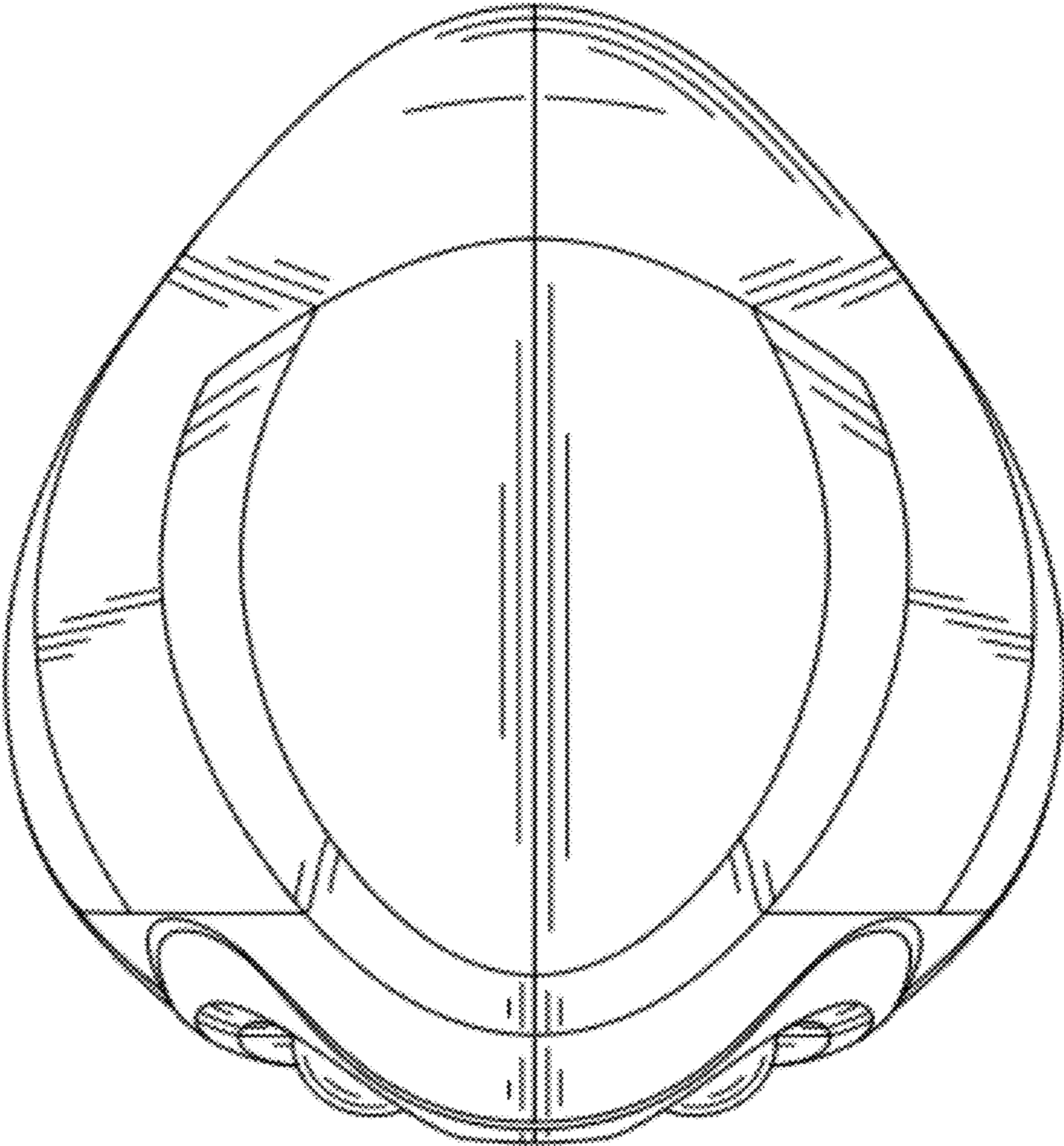

FIG. 6

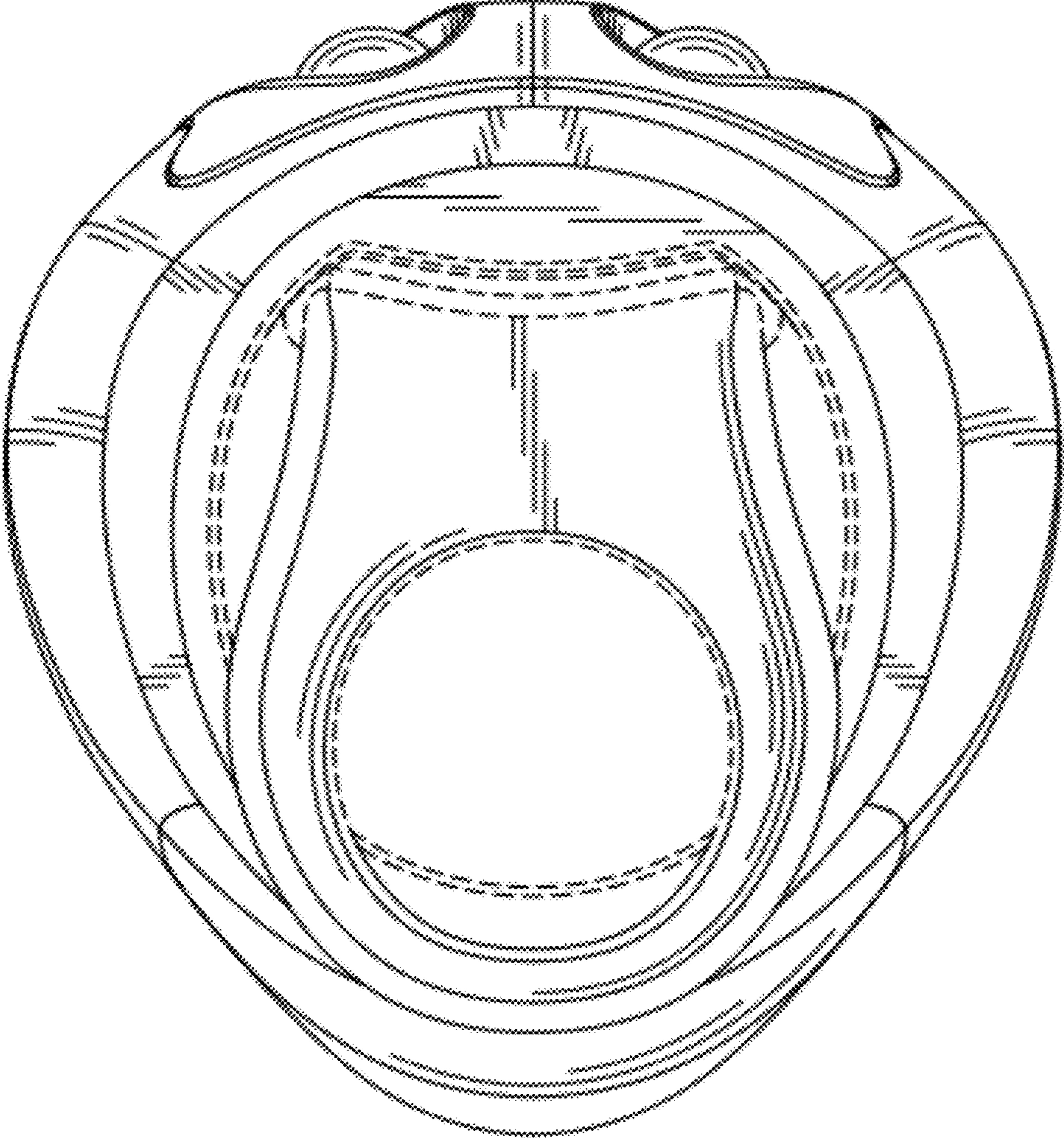

FIG. 7