

US00D666318S

(12) **United States Design Patent**
MacDonald

(10) **Patent No.:** **US D666,318 S**
(45) **Date of Patent:** **** Aug. 28, 2012**

- (54) **LANDSCAPING BLOCK**
- (75) Inventor: **Robert A. MacDonald**, Plymouth, MN (US)
- (73) Assignee: **Keystone Retaining Wall Systems, Inc.**, Bloomington, MN (US)
- (**) Term: **14 Years**
- (21) Appl. No.: **29/403,310**
- (22) Filed: **Oct. 4, 2011**

Related U.S. Application Data

- (62) Division of application No. 29/386,331, filed on Feb. 28, 2011, now Pat. No. Des. 647,632.
- (51) **LOC (9) Cl.** **25-01**
- (52) **U.S. Cl.** **D25/113**
- (58) **Field of Classification Search** D25/102-118, D25/136, 138, 140, 151, 152, 153, 156-162, D25/164; D21/484-491, 499-504; 405/16, 405/284, 286; 52/503-505, 574, 575, 596-612; 404/27-42

See application file for complete search history.

(56) **References Cited**

U.S. PATENT DOCUMENTS

4,197,669	A	4/1980	Hynes	
4,496,266	A	1/1985	Ruckstuhl	
D280,024	S	8/1985	Risi et al.	
D315,026	S	2/1991	Castonguay et al.	
5,003,746	A *	4/1991	Wilston	52/608
5,426,888	A	6/1995	Gnaedig	
D361,853	S	8/1995	Northrop	
5,568,994	A	10/1996	Dawson	
5,601,384	A	2/1997	Dawson	
D380,560	S	7/1997	Forsberg	
D381,086	S	7/1997	Forsberg	
D384,168	S	9/1997	Stevenson	
D387,434	S	12/1997	Dawson	
D397,230	S	8/1998	Forsberg	

D397,808	S	9/1998	Dawson	
5,865,006	A	2/1999	Dawson	
5,913,790	A	6/1999	Dawson	
D426,322	S	6/2000	Anderson et al.	
D430,308	S	8/2000	Dawson	
6,102,374	A	8/2000	Macri	
6,149,352	A	11/2000	MacDonald	
D435,305	S *	12/2000	Pullen et al.	D25/164
D448,856	S	10/2001	Boone	
D448,857	S	10/2001	Staten et al.	
D448,859	S *	10/2001	Doman	D25/113
D448,861	S	10/2001	Daniels et al.	
D459,006	S	6/2002	Staten et al.	
D461,566	S	8/2002	Ogawa et al.	
D464,147	S	10/2002	Van Cauwenbergh	
6,536,994	B2	3/2003	Race	
D475,147	S	5/2003	Ogawa et al.	
6,591,547	B1	7/2003	Staten et al.	
D479,341	S	9/2003	Scullion et al.	

(Continued)

OTHER PUBLICATIONS

U.S. Appl. No. 29/366,124, filed Jul. 20, 2010 (59 pages).

Primary Examiner — Anhdao Doan

(74) *Attorney, Agent, or Firm* — Popovich, Wiles & O'Connell, P.A.

(57) **CLAIM**

The ornamental design for a landscaping block, as shown and described.

DESCRIPTION

FIG. 1 is a left and front perspective view of a landscaping block according to my new design; FIG. 2 is a right and front perspective view thereof; FIG. 3 is a left side elevational view thereof; FIG. 4 is a right side elevational view thereof; FIG. 5 is a front elevational view thereof; FIG. 6 is a rear elevational view thereof; FIG. 7 is a top plan view thereof; and, FIG. 8 is a bottom plan view thereof.

1 Claim, 8 Drawing Sheets

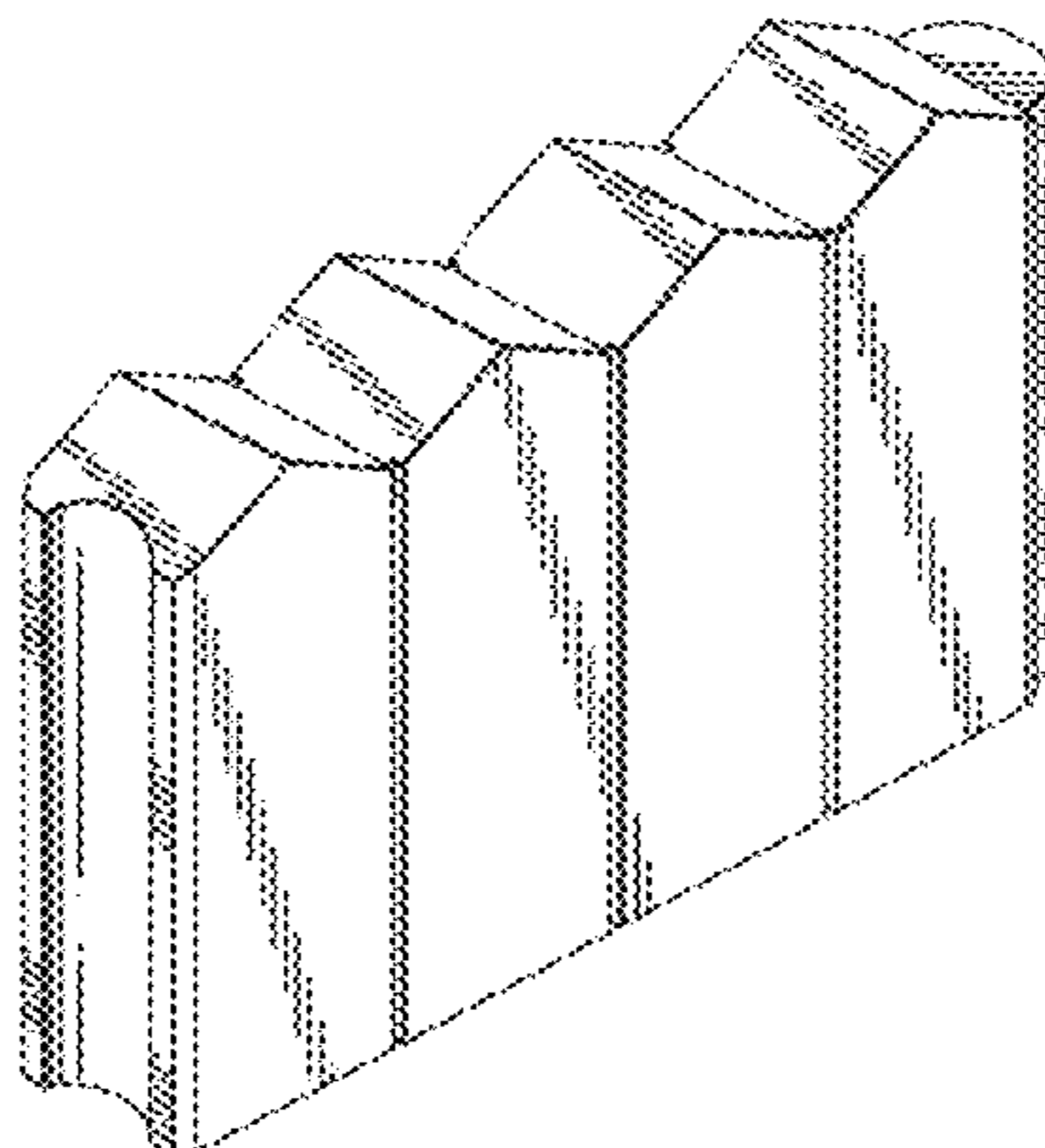

US D666,318 S

Page 2

U.S. PATENT DOCUMENTS					
D479,611 S	9/2003	Ogawa et al.	D572,832 S *	7/2008	Gratner et al. D25/113
6,615,561 B2	9/2003	MacDonald et al.	D574,515 S	8/2008	Bouchard
6,668,484 B2	12/2003	Riccobene	D610,710 S	2/2010	LaCroix et al.
D488,242 S	4/2004	MacDonald	D613,430 S	4/2010	Perotti
D488,568 S	4/2004	MacDonald	D621,070 S	8/2010	MacDonald et al.
D488,569 S	4/2004	Dawson	D624,213 S	9/2010	Perotti
D490,542 S	5/2004	MacDonald	2005/0050823 A1 *	3/2005	Whitson 52/311.1
D491,675 S	6/2004	Ogawa et al.	2006/0110223 A1	5/2006	Dawson
6,821,058 B1	11/2004	Dawson	2008/0277561 A1	11/2008	MacDonald
D501,934 S	2/2005	Mushett	2008/0289282 A1	11/2008	MacDonald
D501,935 S	2/2005	Dawson et al.	2008/0307740 A1	12/2008	MacDonald
6,854,231 B2	2/2005	MacDonald et al.	2009/0120029 A1	5/2009	LaCroix et al.
D512,784 S *	12/2005	Quintana D25/115	2009/0188196 A1	7/2009	MacDonald
D516,736 S	3/2006	Mushett et al.	2009/0308015 A1	12/2009	MacDonald et al.
7,168,218 B2	1/2007	Spratlen et al.	2011/0072753 A1	3/2011	MacDonald
7,168,892 B1	1/2007	MacDonald et al.	2011/0217127 A1	9/2011	MacDonald
D539,927 S	4/2007	Whitson	2011/0243669 A1	10/2011	Friederichs et al.

* cited by examiner

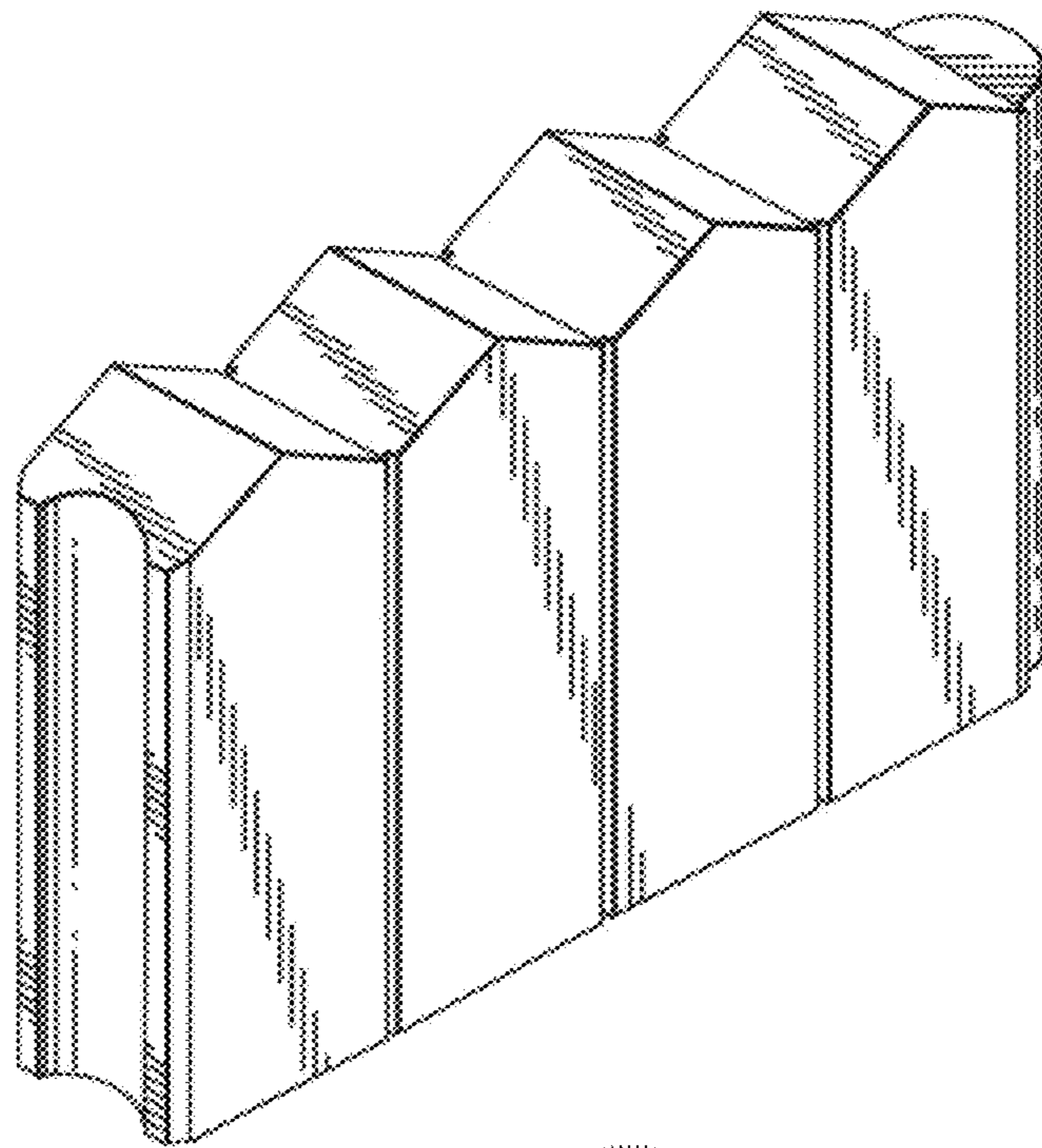

Fig. 1

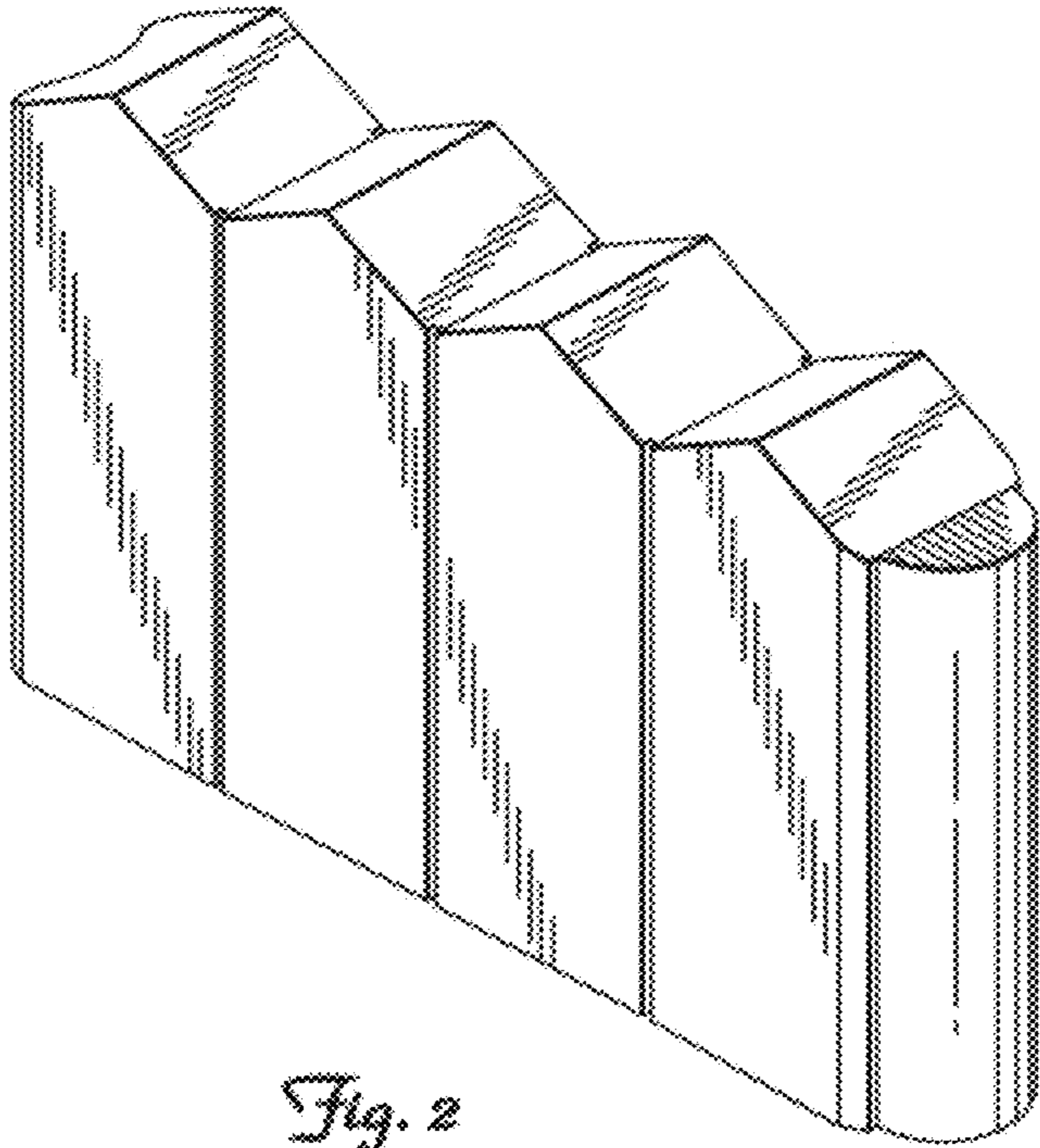

Fig. 2

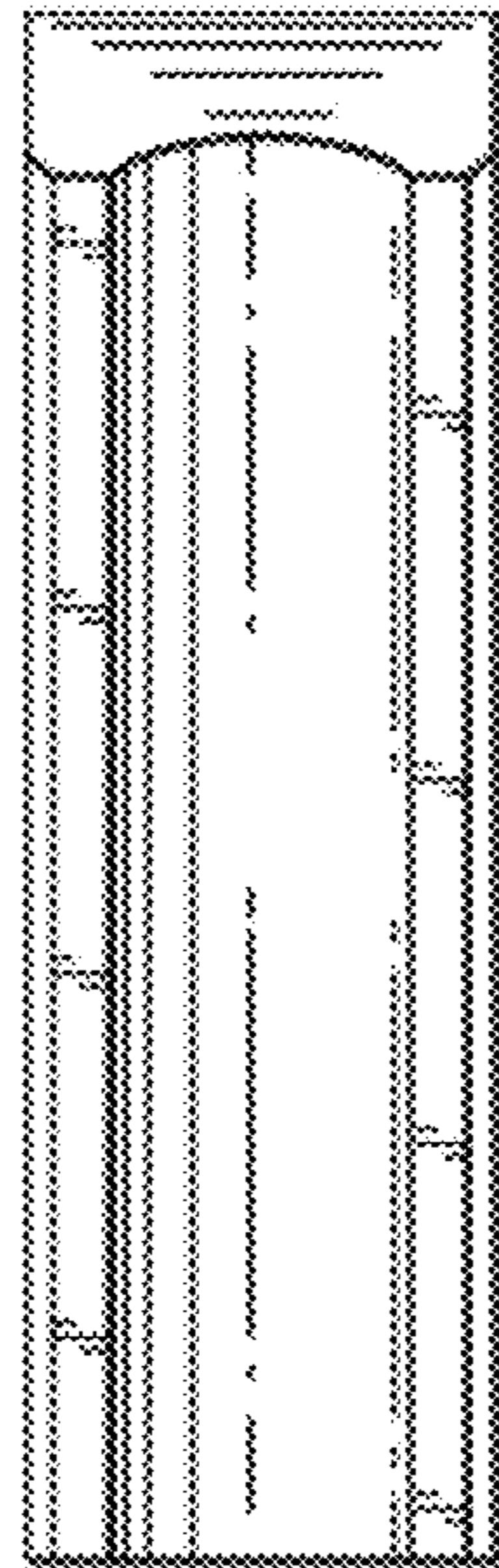

Fig. 3

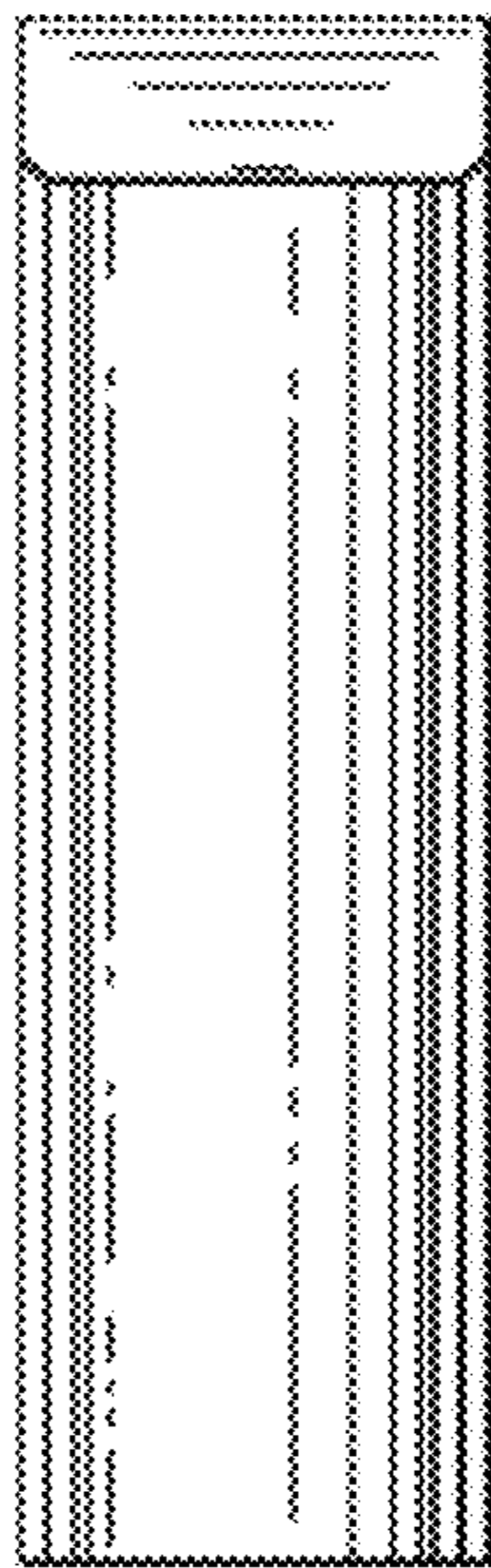

Fig. 4

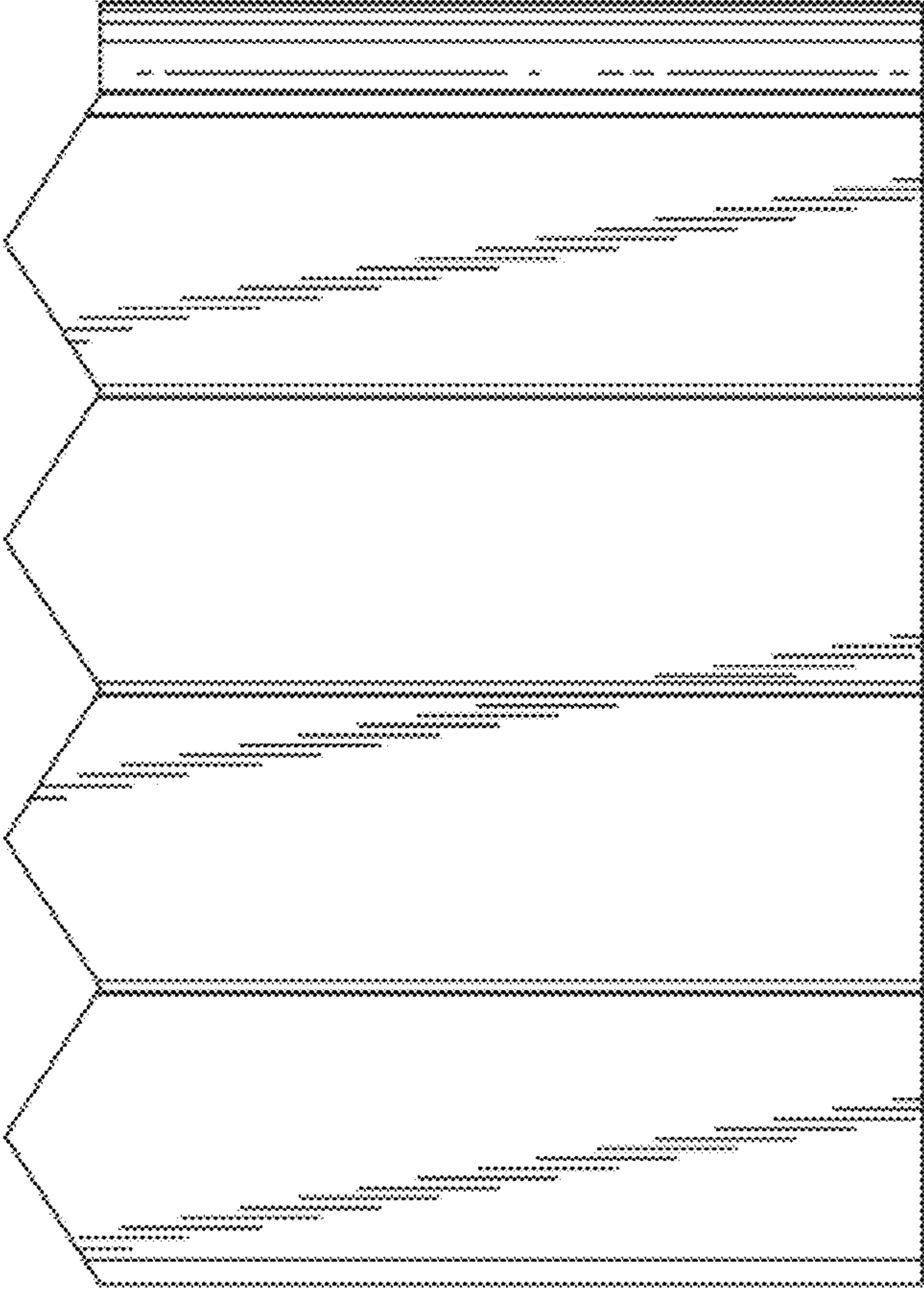

Fig. 5

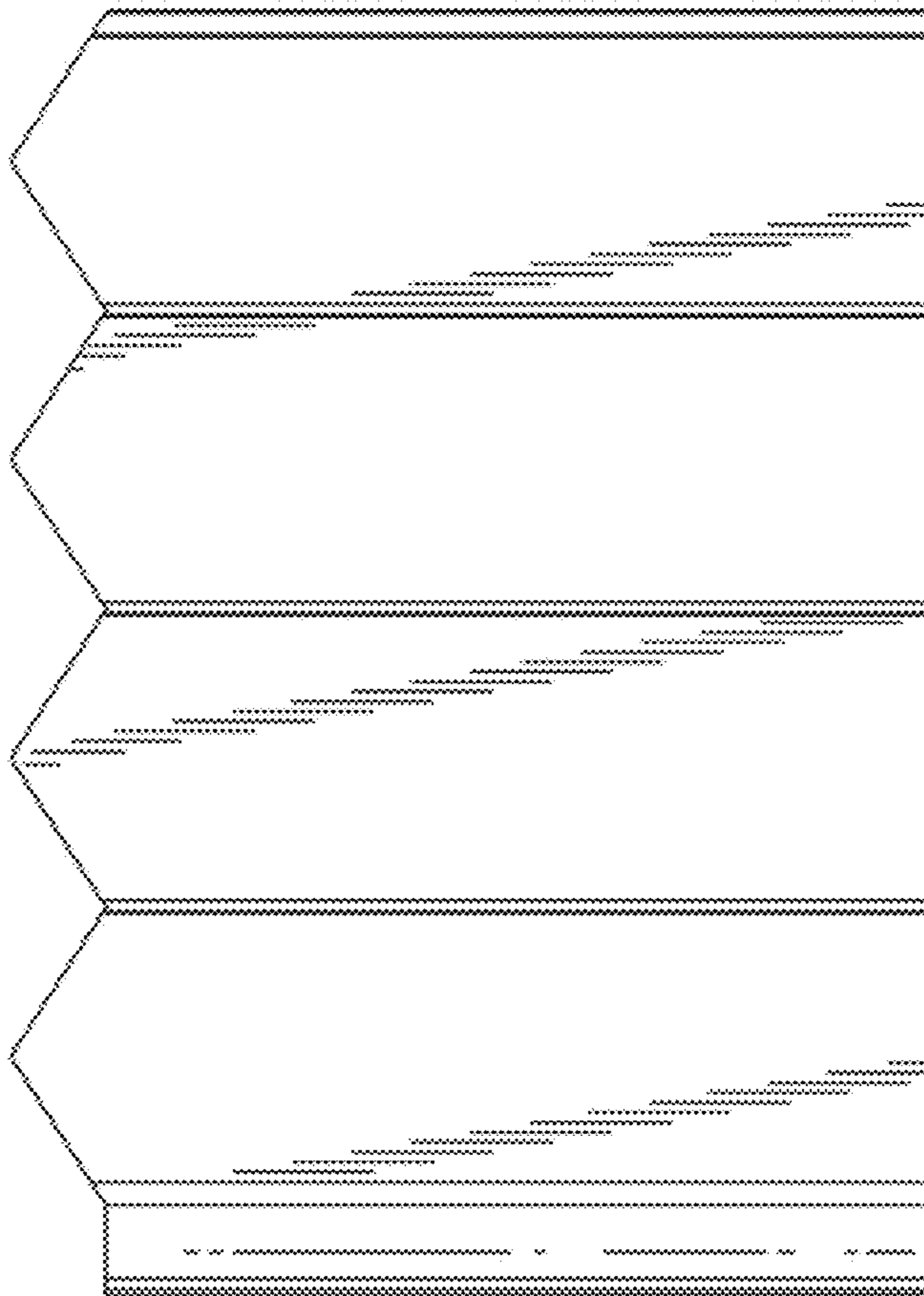

Fig. 6

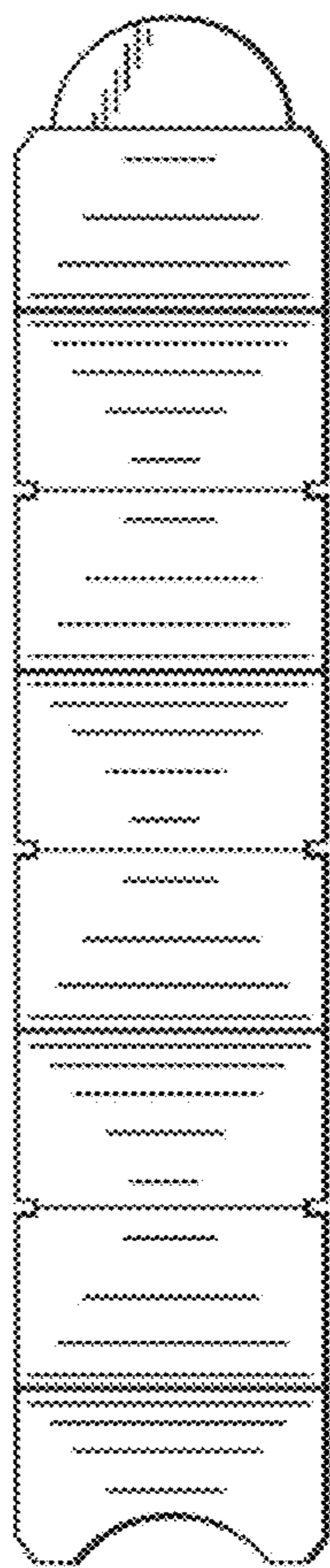

Fig. 7

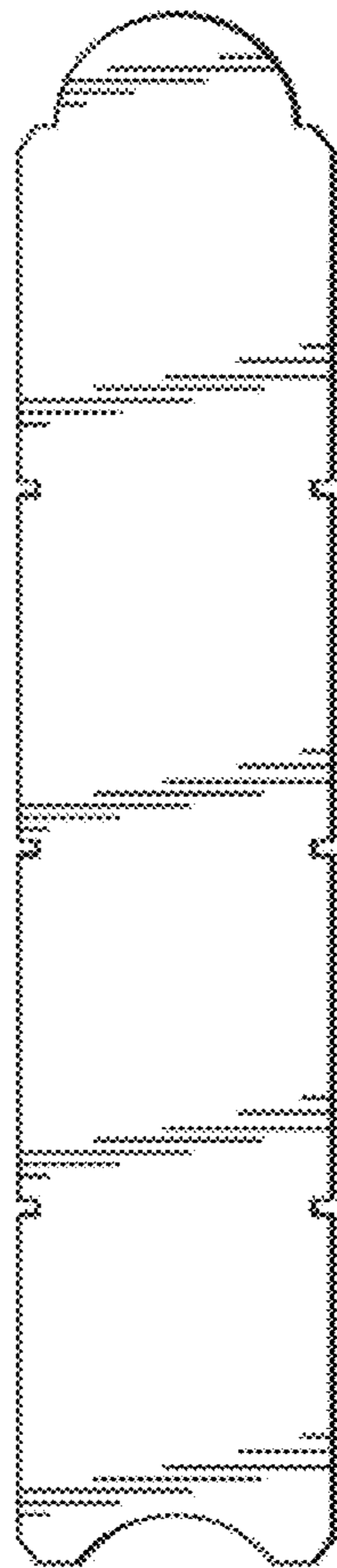

Fig. 8