



US00D666295S

(12) **United States Design Patent**
Hung

(10) **Patent No.:** **US D666,295 S**

(45) **Date of Patent:** **** Aug. 28, 2012**

(54) **DENTAL IMPLANT**

(76) Inventor: **William Y. S. Hung**, Rancho Cucamonga, CA (US)

(**) Term: **14 Years**

(21) Appl. No.: **29/374,795**

(22) Filed: **Oct. 5, 2011**

(51) **LOC (9) Cl.** **24-03**

(52) **U.S. Cl.** **D24/156**

(58) **Field of Classification Search** D24/155-156,
D24/176; D8/387; 433/172-176; 623/17.16,
623/17.17, 23.26, 23.27, 11.11

See application file for complete search history.

(56) **References Cited**

U.S. PATENT DOCUMENTS

5,195,892	A *	3/1993	Gersberg	433/174
5,246,369	A *	9/1993	Poulmaire	433/173
5,628,630	A *	5/1997	Misch et al.	433/174
5,642,996	A *	7/1997	Mochida et al.	433/174
5,823,777	A *	10/1998	Misch et al.	433/174
6,135,772	A *	10/2000	Jones	433/174
D565,181	S *	3/2008	Anitua Aldecoa	D24/156
D577,122	S *	9/2008	Aldecoa	D24/156
D583,945	S *	12/2008	Anitua Aldecoa	D24/156
D588,699	S *	3/2009	Aldecoa	D24/156
2008/0118893	A1 *	5/2008	Armellini et al.	433/174

2011/0070557	A1 *	3/2011	Elyav	433/174
2011/0111369	A1 *	5/2011	Laster et al.	433/174
2011/0244427	A1 *	10/2011	Hung	433/174
2011/0250564	A1 *	10/2011	Hung	433/174

* cited by examiner

Primary Examiner — Wan Laymon

(74) *Attorney, Agent, or Firm* — Raymond Y. Chan; David and Raymond Patent Firm

(57) **CLAIM**

The ornamental design for a dental implant, as shown and described.

DESCRIPTION

FIG. 1 is a perspective view of dental implant showing my new design.

FIG. 2 is a top view thereof.

FIG. 3 is a front view thereof.

FIG. 4 is a rear view thereof.

FIG. 5 is a left view thereof; and,

FIG. 6 is a right view thereof.

The dash-dot-dot line immediately adjacent the claimed area in FIGS. 1 and 2 represents the bounds of the claimed design, while all other dash-dot-dot lines in the figure drawings are depict environmental subject matter only; the dash-dot-dot lines form no part of the claimed design.

1 Claim, 1 Drawing Sheet

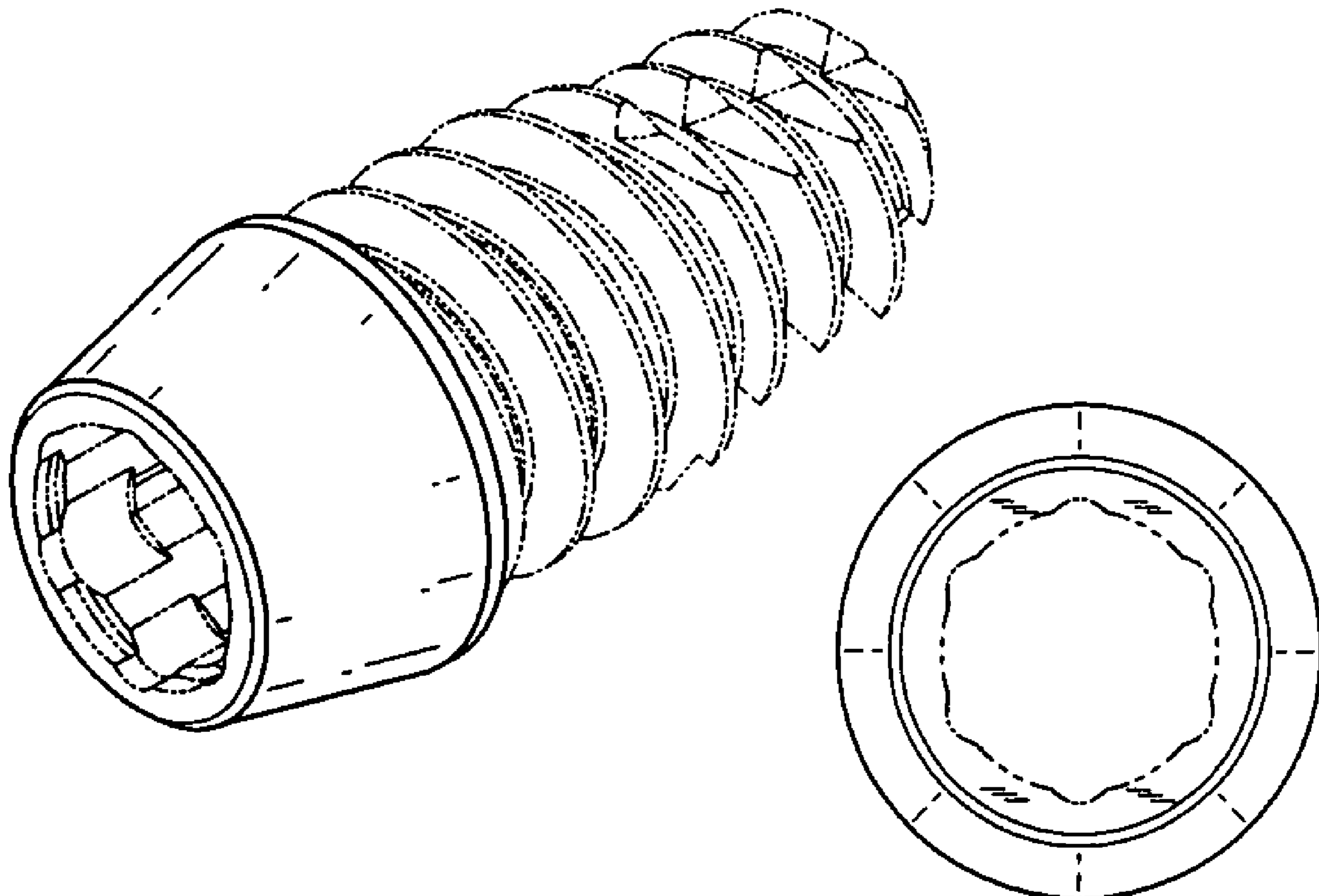

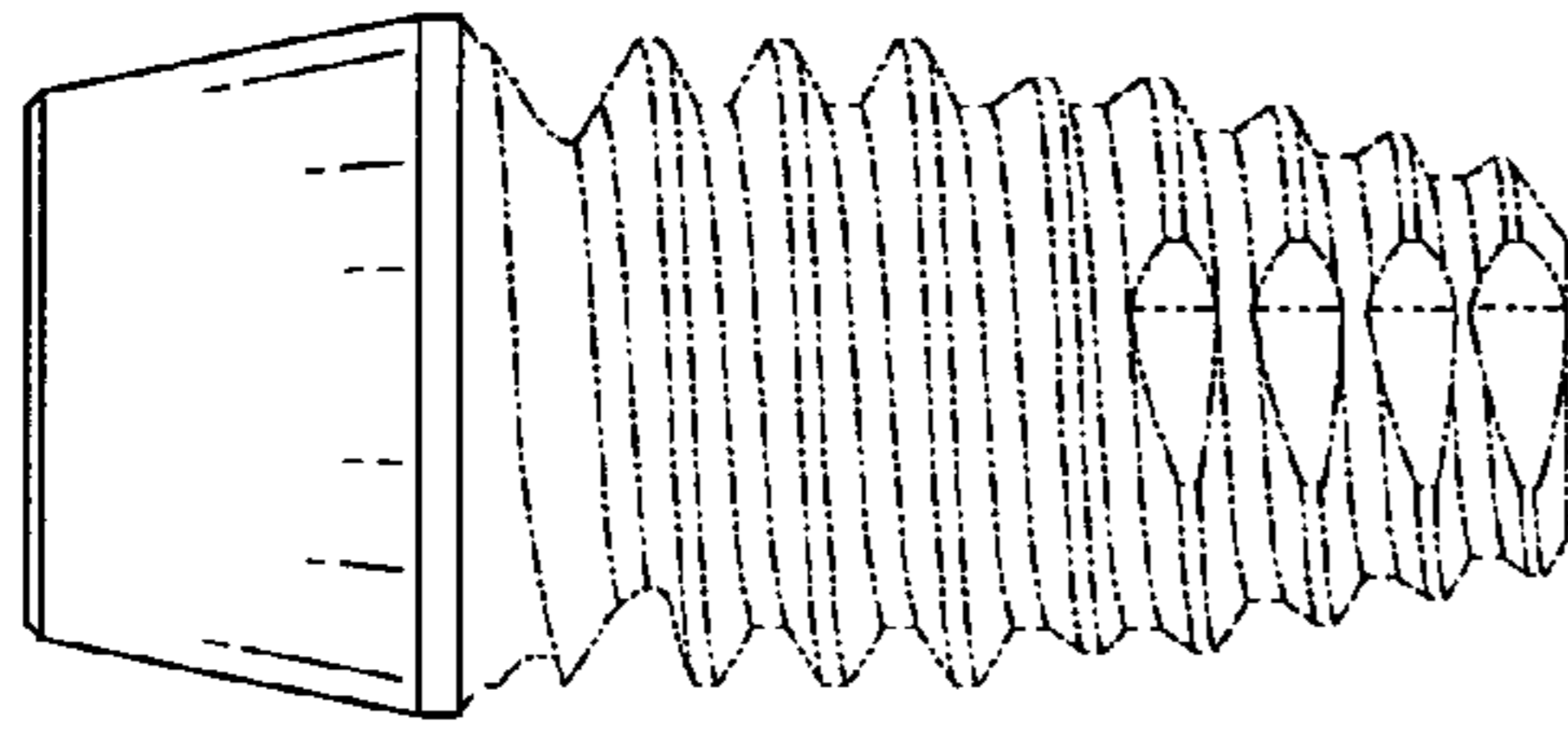

FIG.3

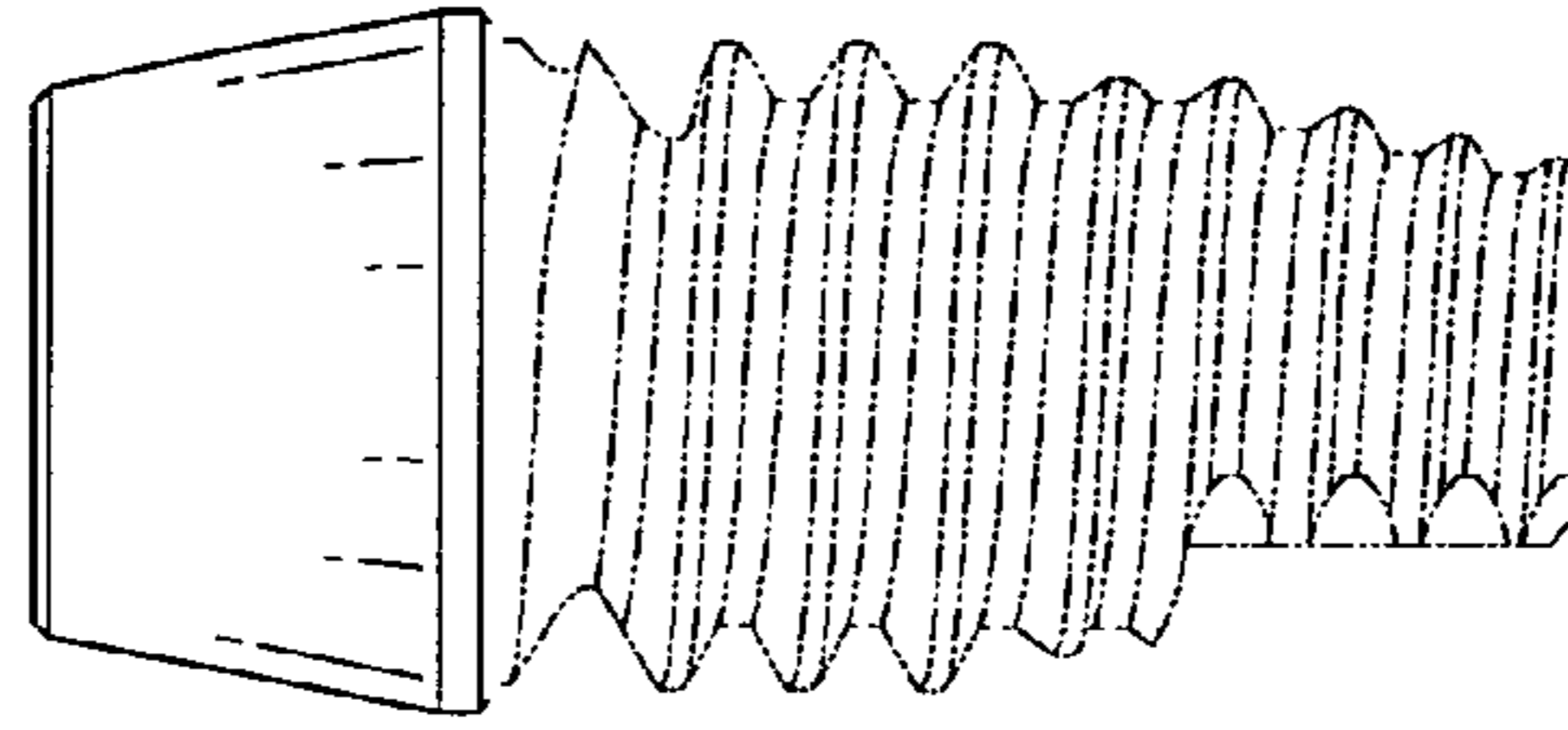

FIG.6

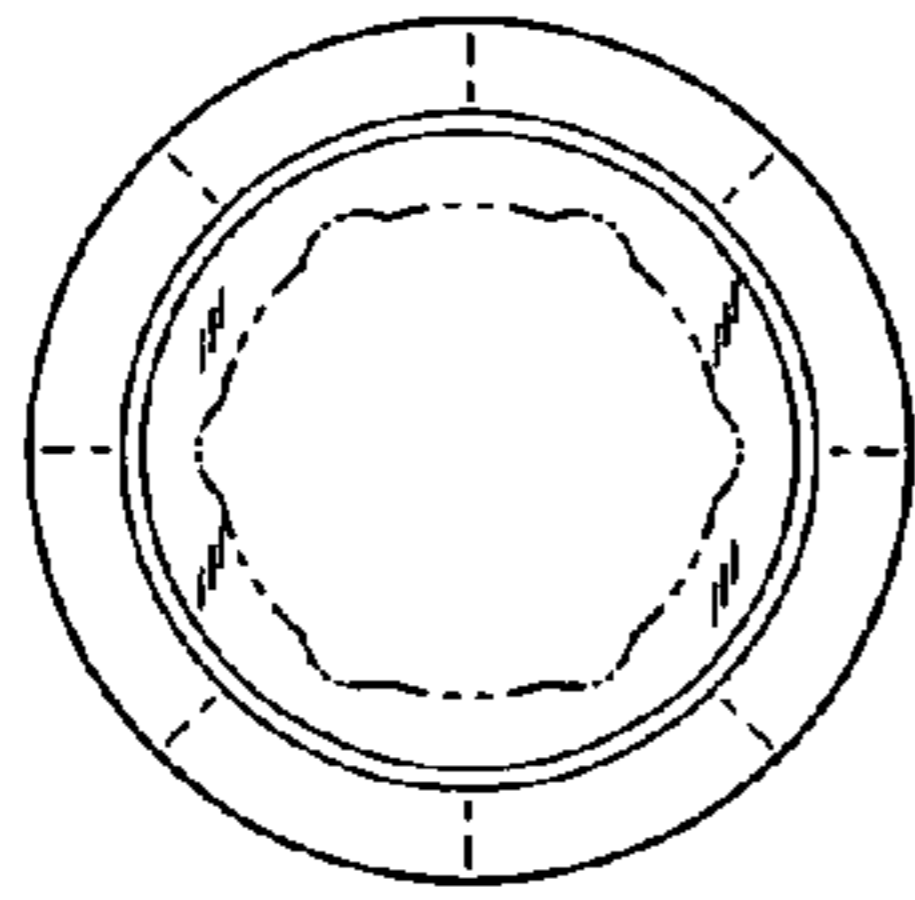

FIG.2

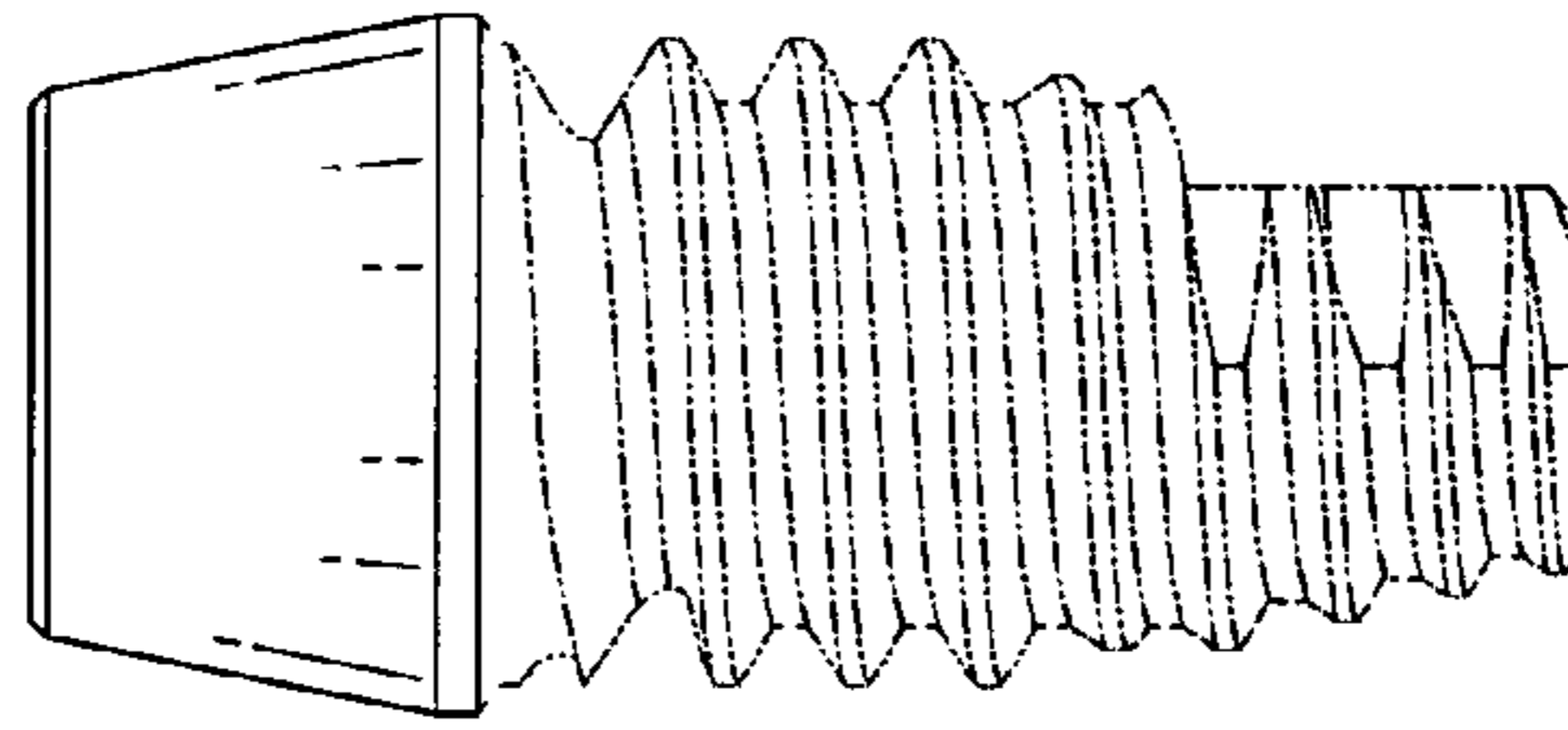

FIG.5

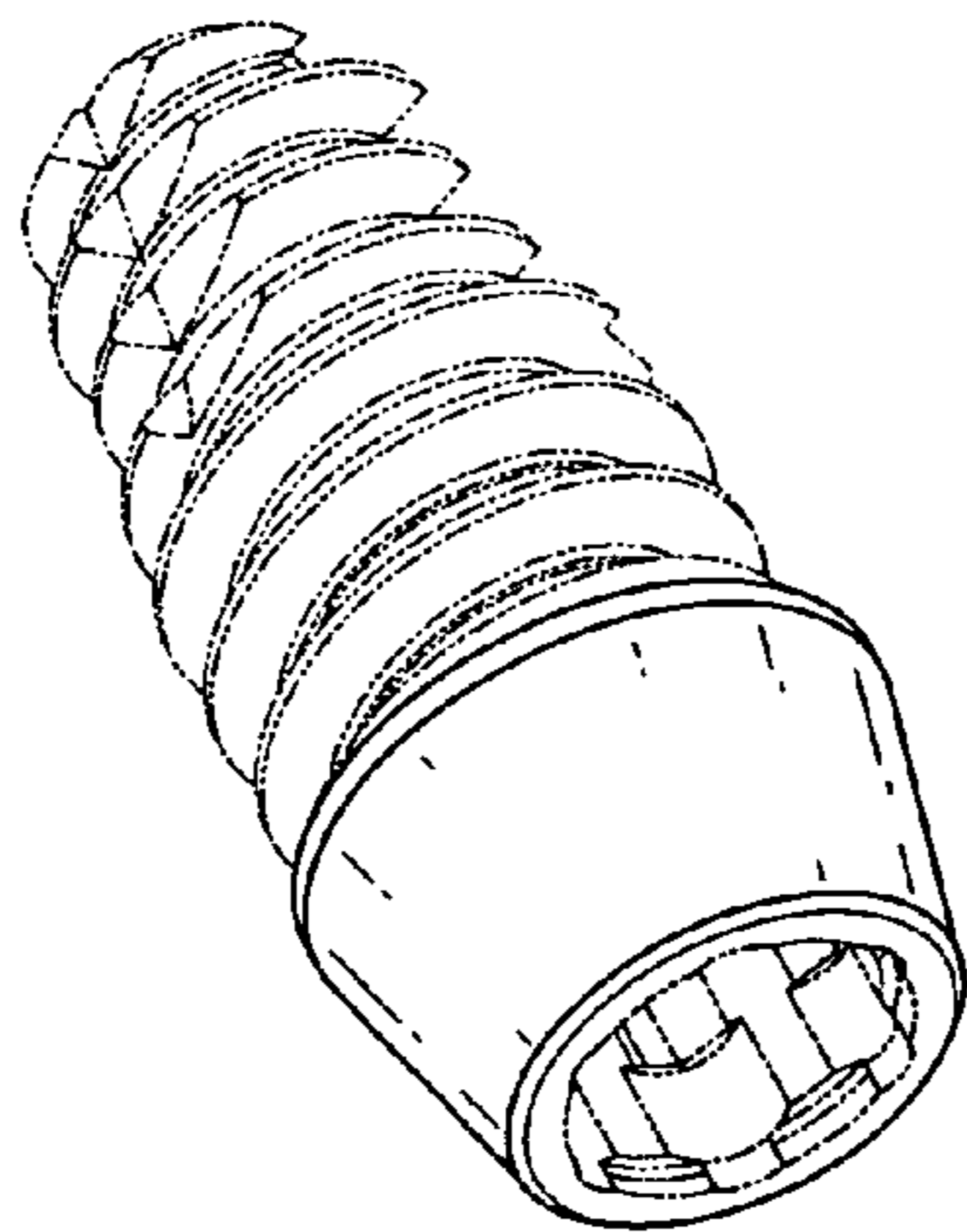

FIG.1

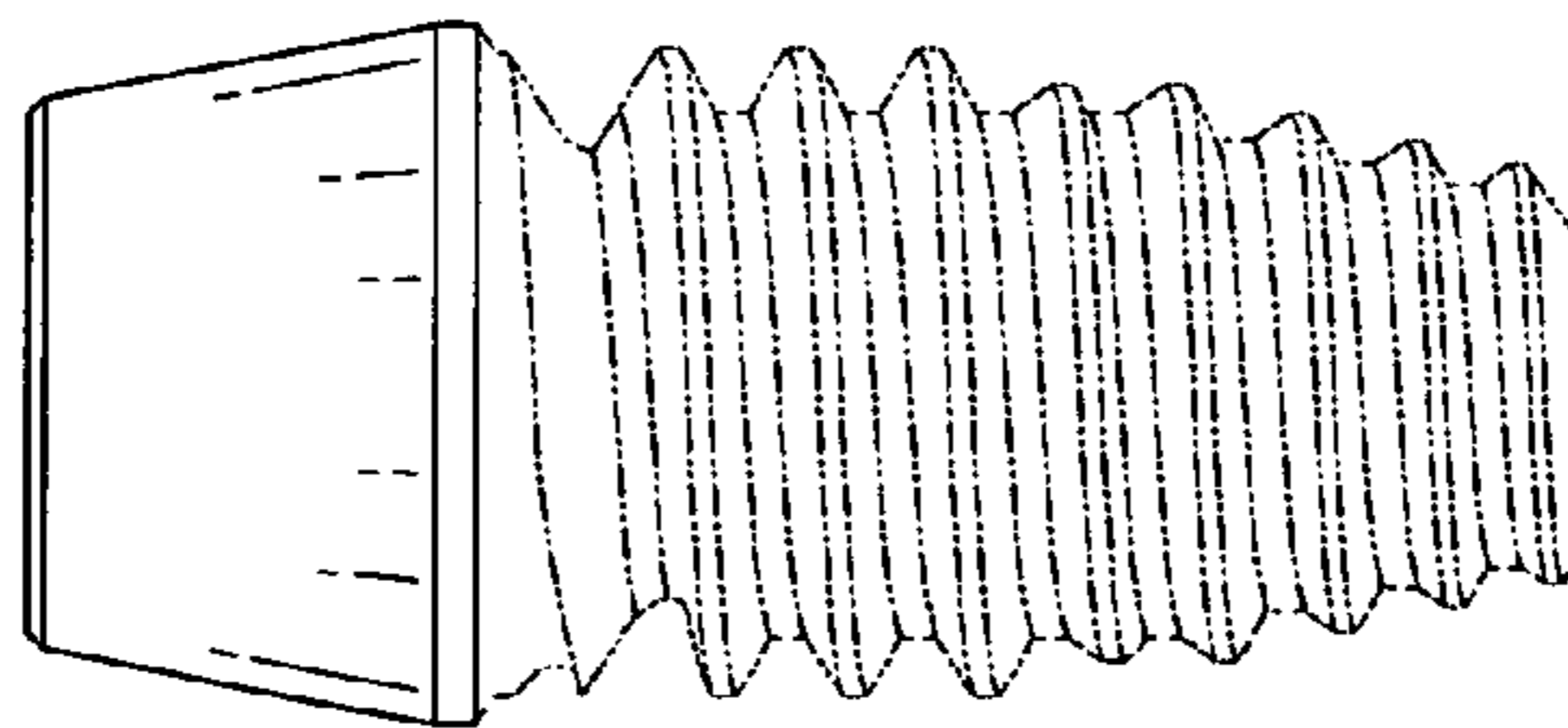

FIG.4