



US00D666261S

(12) **United States Design Patent**
Roach et al.

(10) **Patent No.:** **US D666,261 S**

(45) **Date of Patent:** **** Aug. 28, 2012**

(54) **GOLF CLUB HEAD**

(75) Inventors: **Ryan L. Roach**, Carlsbad, CA (US);
Douglas E. Roberts, Carlsbad, CA (US);
Austin B. Oliveiro, San Marcos, CA
(US); **Mitchell E. Bac**, Temecula, CA
(US); **Philamon W. Rodgers**, San
Diego, CA (US)

(73) Assignee: **Cobra Golf Incorporated**, Carlsbad,
CA (US)

(**) Term: **14 Years**

(21) Appl. No.: **29/399,767**

(22) Filed: **Aug. 18, 2011**

(51) **LOC (9) Cl.** **21-02**

(52) **U.S. Cl.** **D21/749**

(58) **Field of Classification Search** D21/747-751,
D21/759; 473/324-331, 350

See application file for complete search history.

(56) **References Cited**

U.S. PATENT DOCUMENTS

D559,931 S	1/2008	Roach et al.	
D559,933 S	1/2008	Roach et al.	
D576,695 S *	9/2008	Foster et al.	D21/747
D586,414 S *	2/2009	Foster et al.	D21/747
D597,617 S *	8/2009	Ines et al.	D21/747
D598,060 S *	8/2009	Barez et al.	D21/747
D622,344 S *	8/2010	Oldknow et al.	D21/759

D639,880 S *	6/2011	Roach et al.	D21/747
D639,883 S *	6/2011	Roach et al.	D21/759
D643,081 S *	8/2011	Roach et al.	D21/759

* cited by examiner

Primary Examiner — Mitchell Siegel

(74) *Attorney, Agent, or Firm* — Mark S. Leonardo; Brown
Rudnick LLP

(57) **CLAIM**

The ornamental design for a golf club head, as shown and
described.

DESCRIPTION

FIG. 1 illustrates a back side perspective view of a golf club
head employing an ornamental design in accordance with the
present invention;

FIG. 2 illustrates a front side view of the golf club head of
FIG. 1;

FIG. 3 illustrates a back side view of the golf club head of
FIG. 1;

FIG. 4 illustrates a bottom side view of the golf club head of
FIG. 1;

FIG. 5 illustrates a top side view of the golf club head of FIG.
1;

FIG. 6 illustrates a heel side view of the golf club head of FIG.
1; and,

FIG. 7 illustrates a toe side view of the golf club head of FIG.
1.

All features illustrated in phantom line are expressly dis-
claimed and form no part of the claimed design.

1 Claim, 5 Drawing Sheets

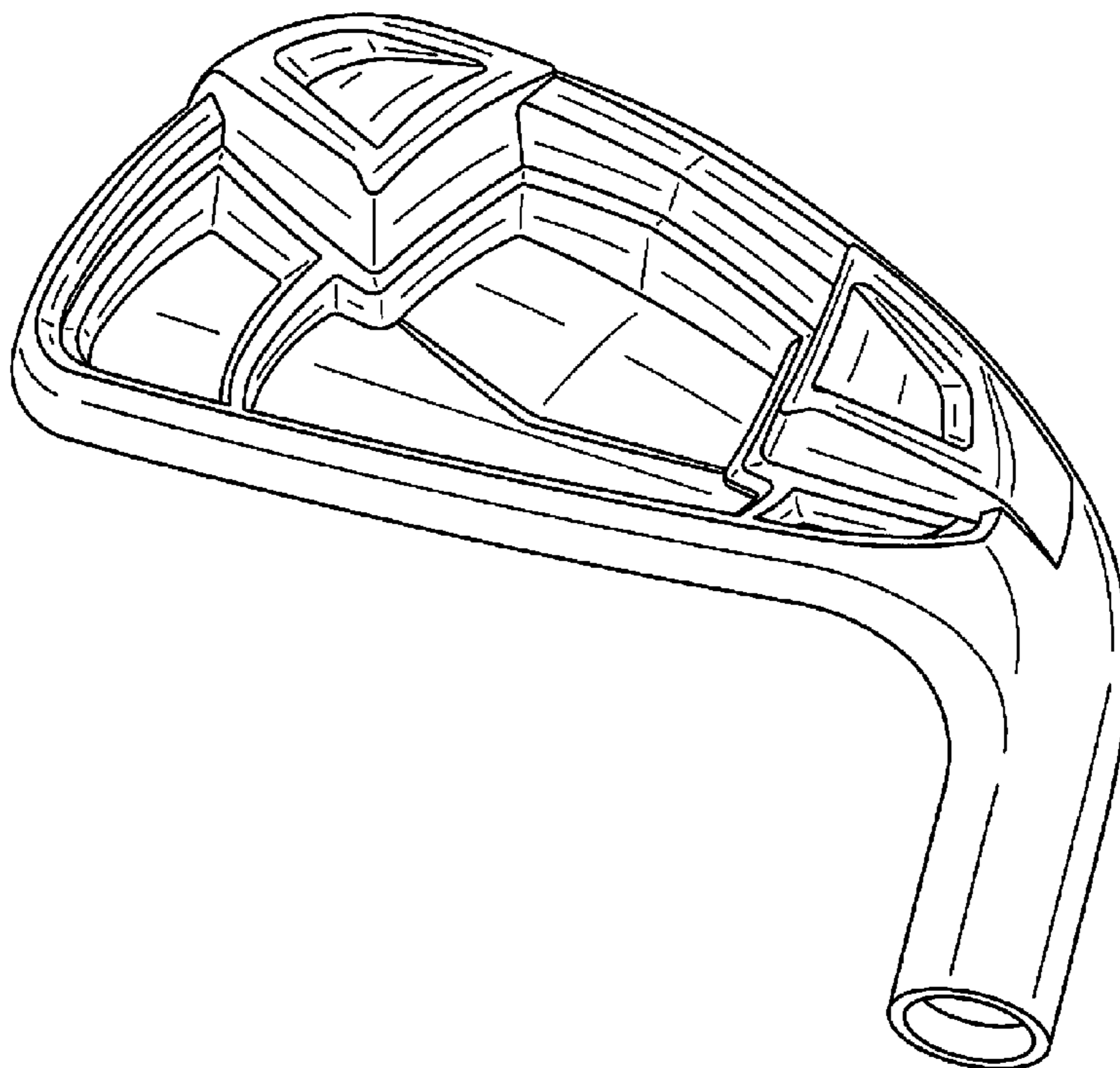

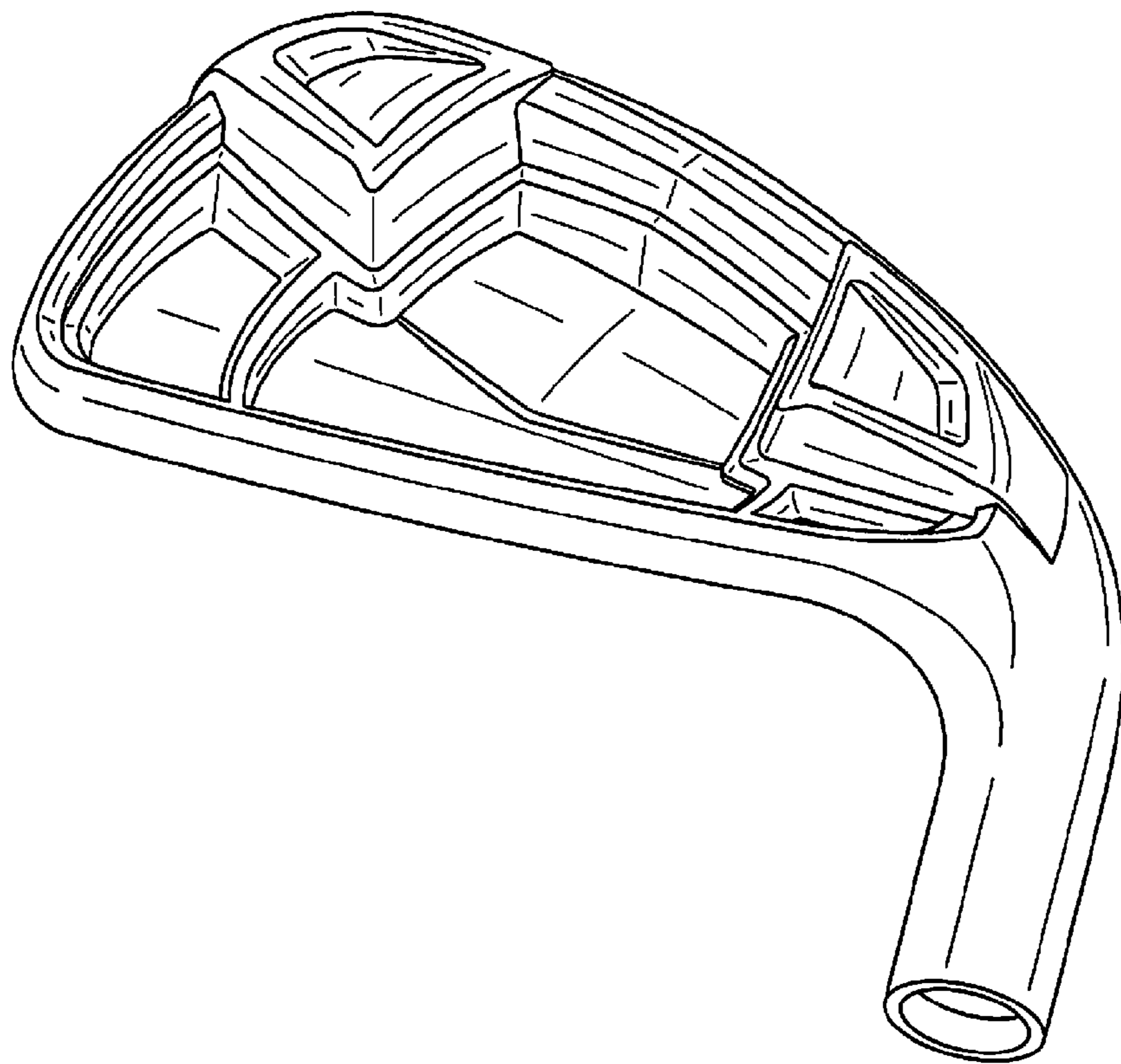

FIG.1

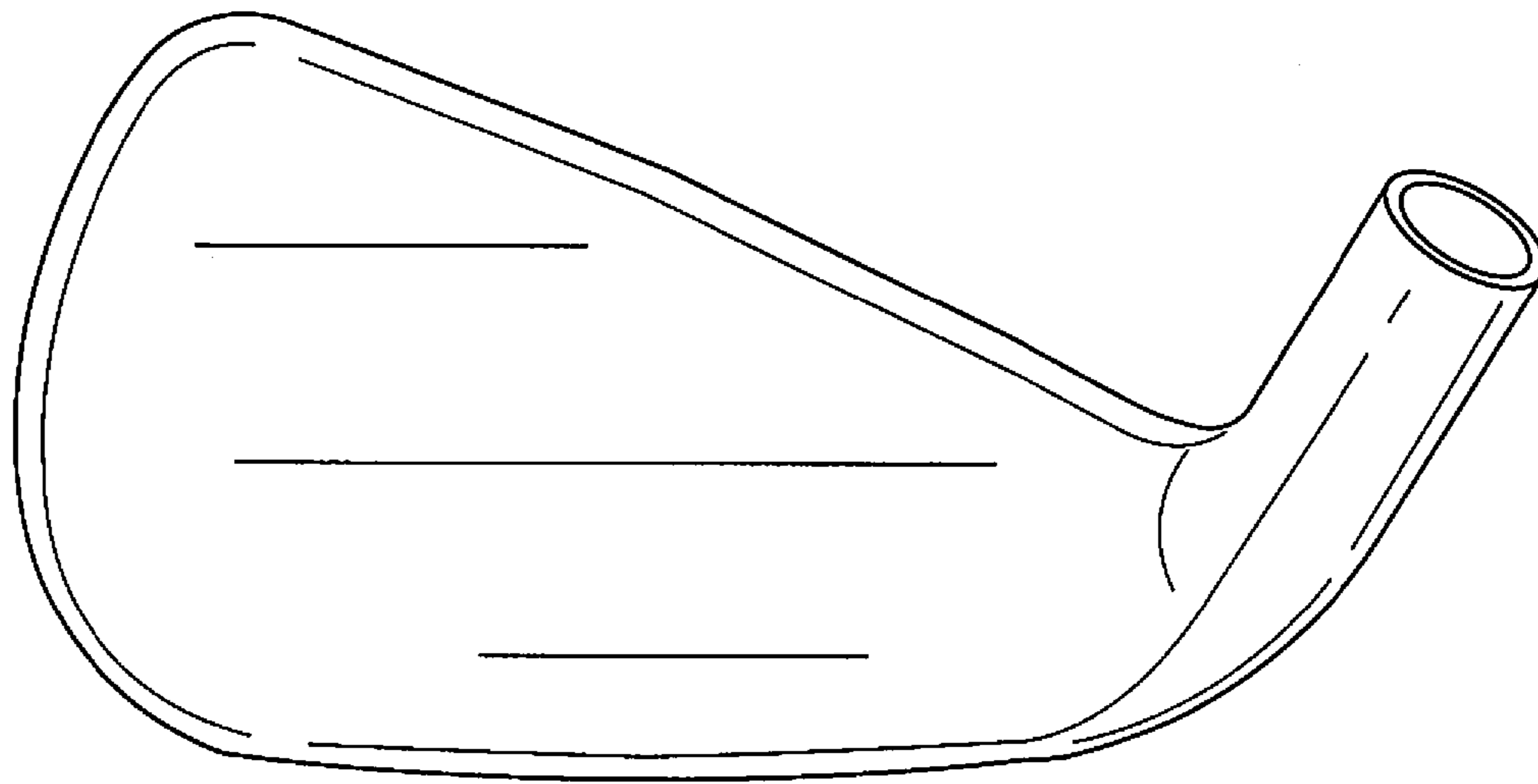

FIG. 2

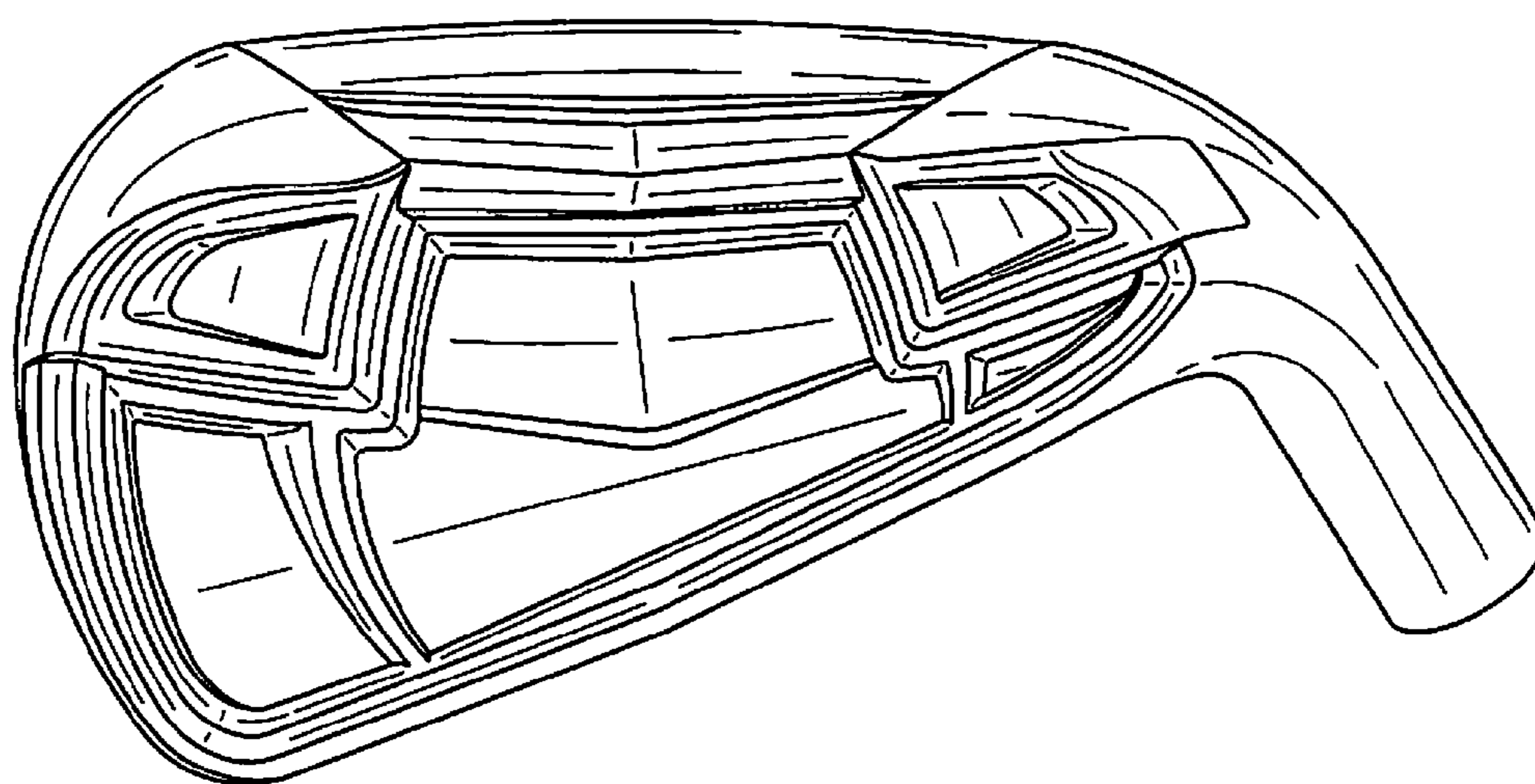

FIG. 3

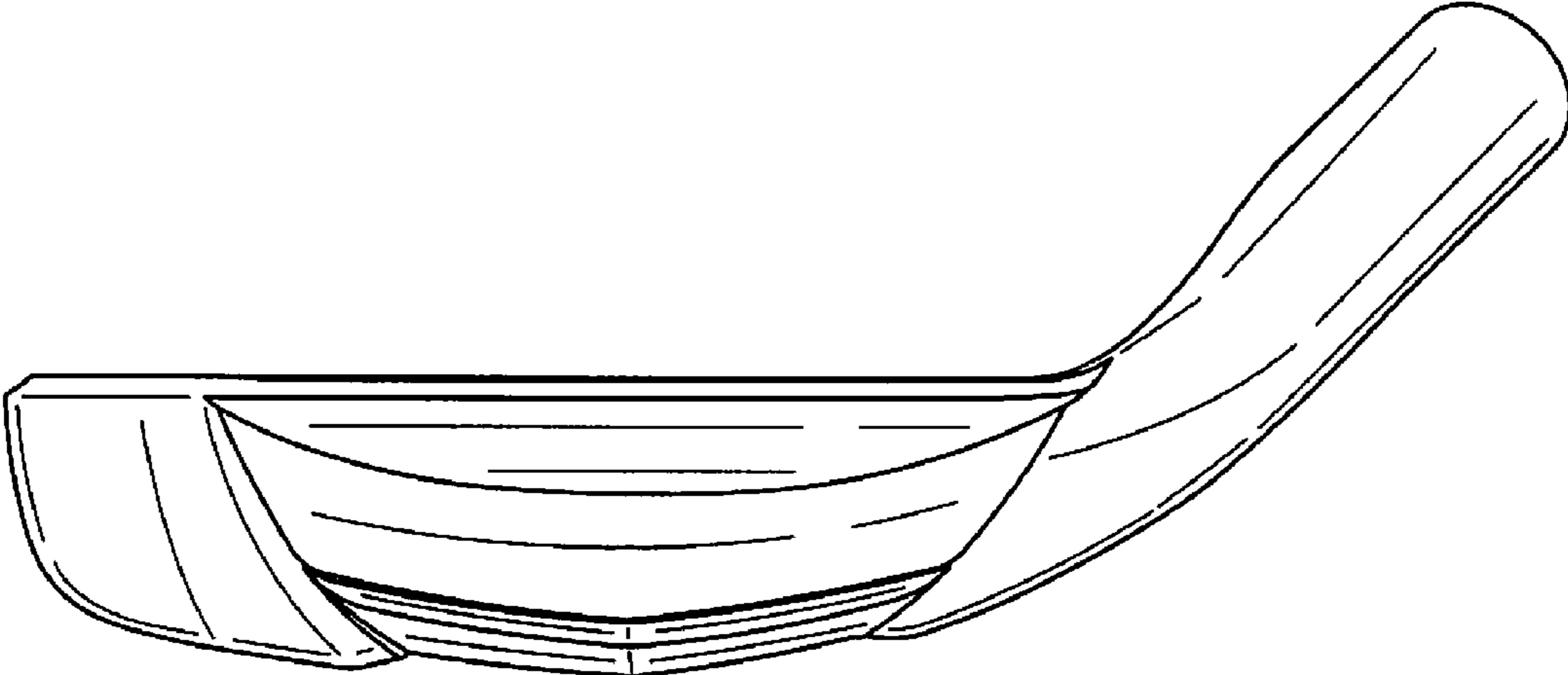

FIG. 4

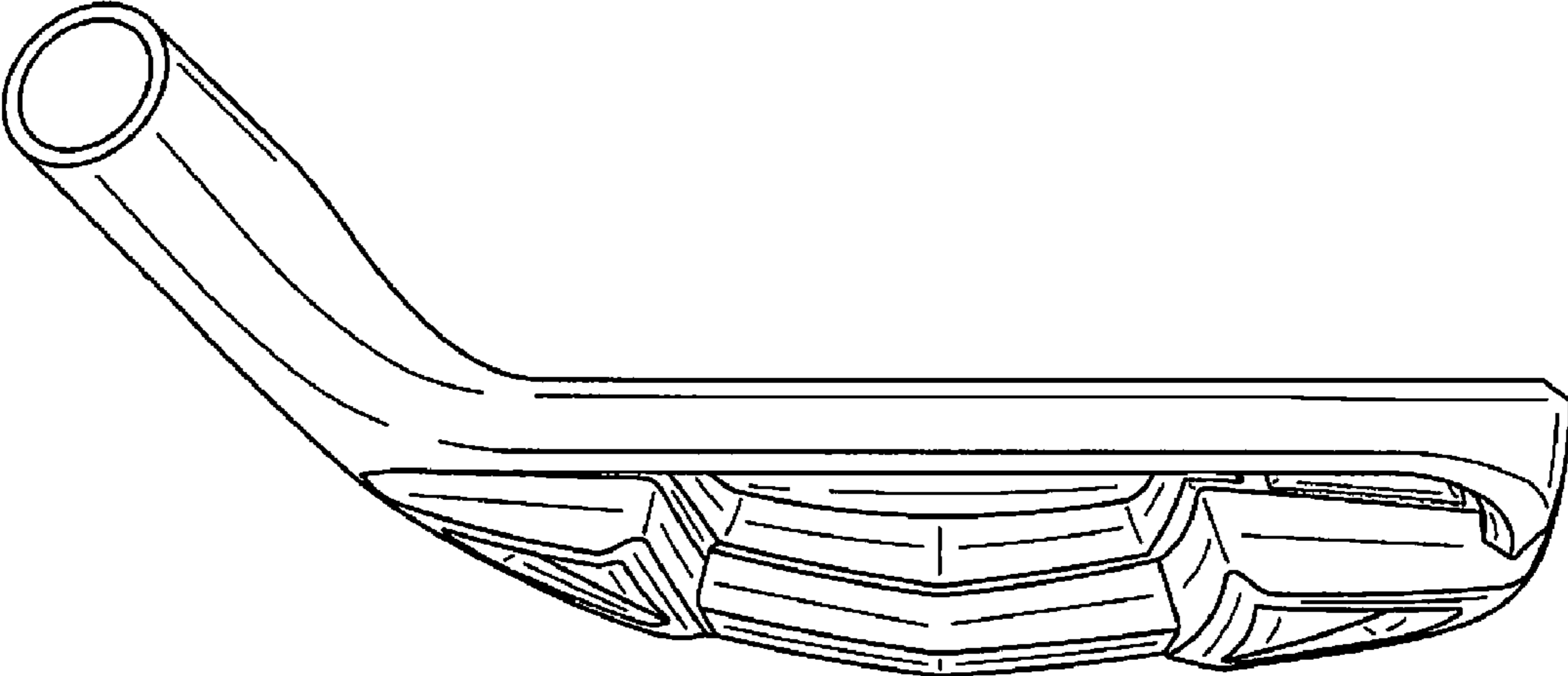

FIG. 5

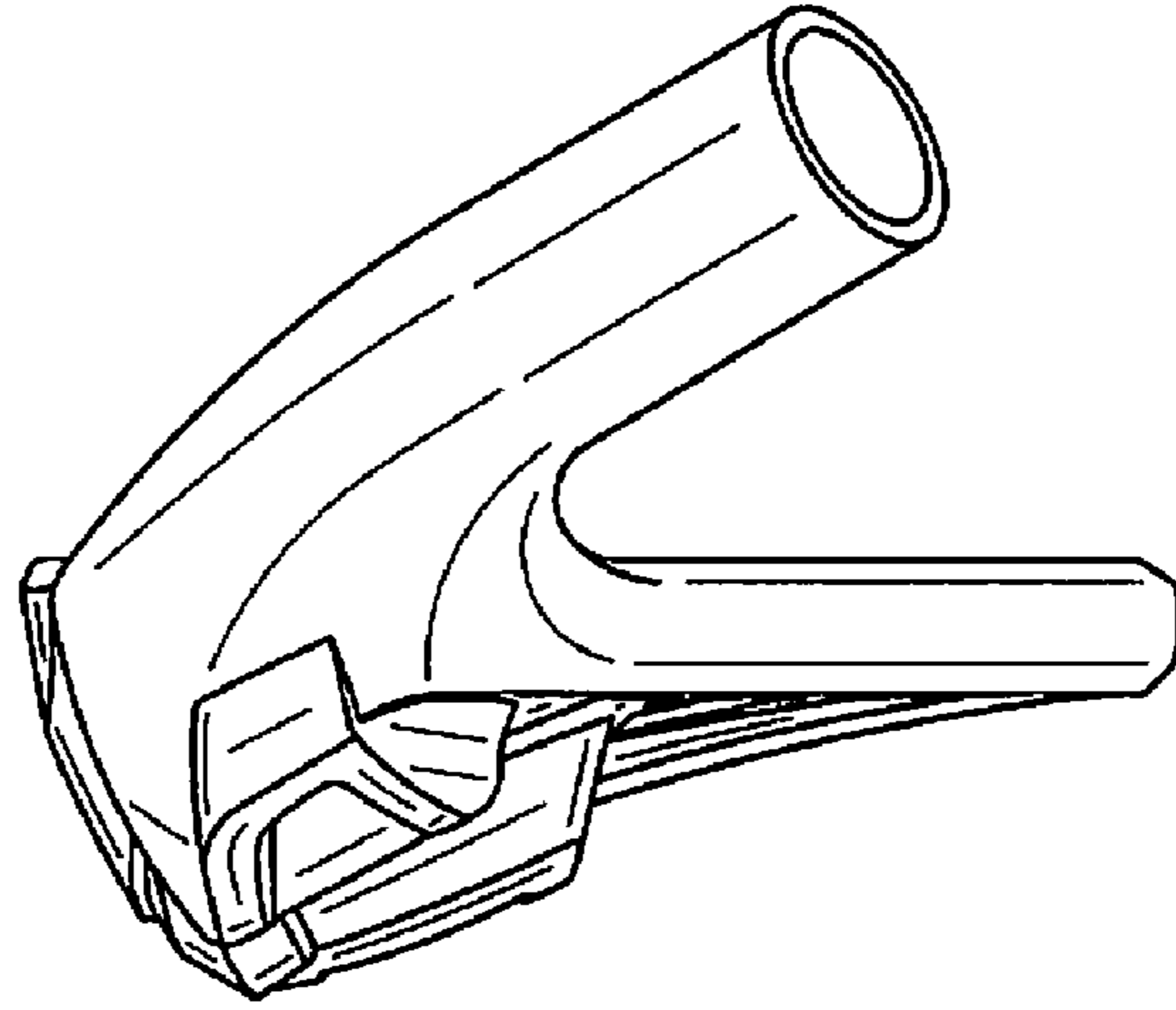

FIG. 6

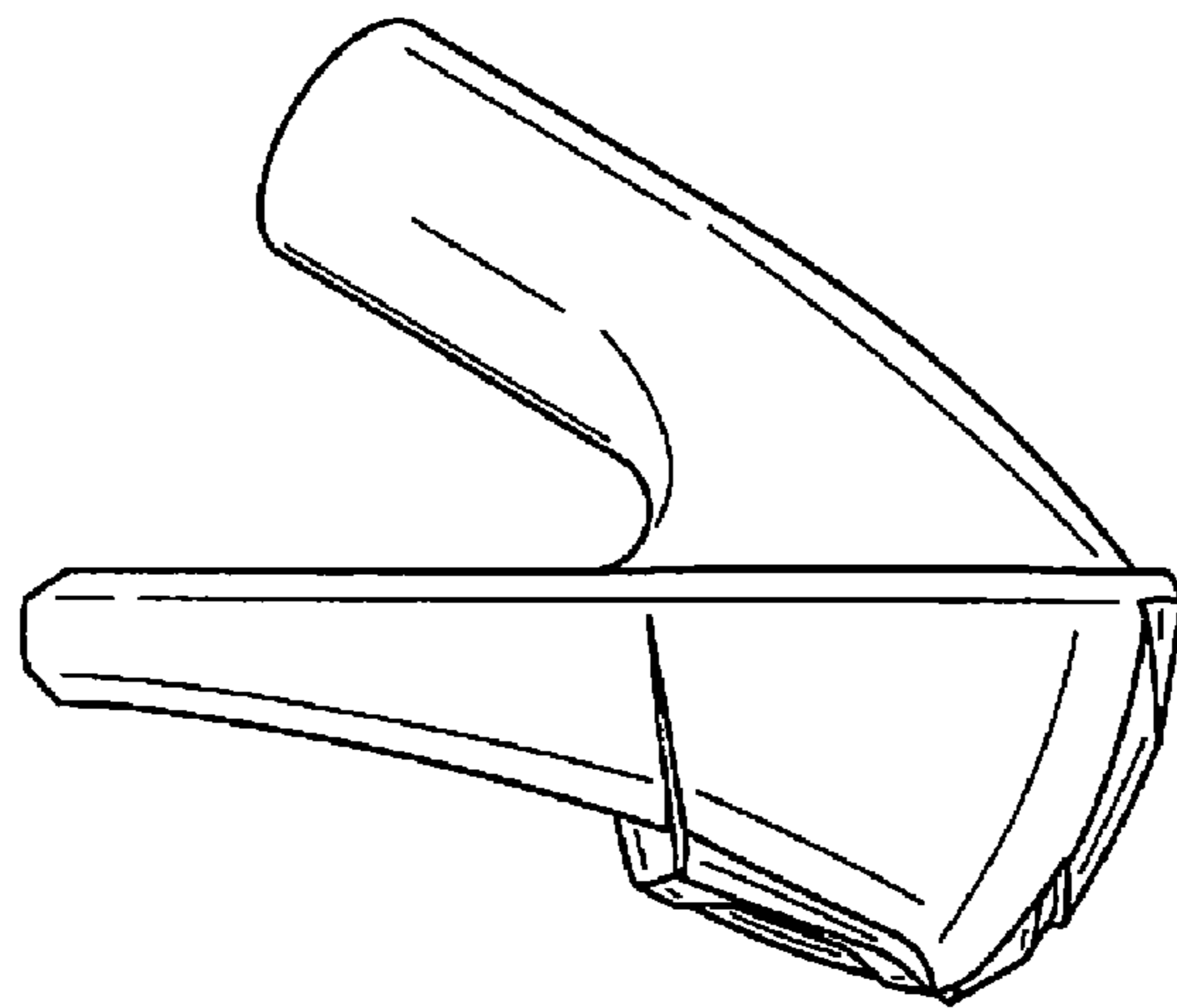

FIG. 7