

US00D666260S

(12) **United States Design Patent**
Cynn

(10) **Patent No.:** **US D666,260 S**

(45) **Date of Patent:** **** Aug. 28, 2012**

(54) **GOLF PUTTER HEAD**

(76) **Inventor:** **Kie Ho Cynn, Kapolei, HI (US)**

(**) **Term:** **14 Years**

(21) **Appl. No.:** **29/373,529**

(22) **Filed:** **Apr. 19, 2011**

(30) **Foreign Application Priority Data**

Feb. 21, 2011	(KR)	30-2011-0006671
Feb. 21, 2011	(KR)	30-2011-0006673
Feb. 21, 2011	(KR)	30-2011-0006675

(51) **LOC (9) Cl.** **21-02**

(52) **U.S. Cl.** **D21/742**

(58) **Field of Classification Search** D21/736-746;
473/324-331, 340-341, 251-256

See application file for complete search history.

(56) **References Cited**

U.S. PATENT DOCUMENTS

D231,624 S *	5/1974	Wilmoth	D21/741
4,369,974 A *	1/1983	Komperda	473/250
D300,839 S *	4/1989	Dupont	D21/738
D325,414 S *	4/1992	Woolsey	D21/737
D401,636 S *	11/1998	Duclos	D21/742
D403,387 S *	12/1998	Bloomer	D21/736
D435,879 S *	1/2001	Jackson	D21/736
7,905,794 B2 *	3/2011	Ross	473/250
D636,828 S *	4/2011	Ross	D21/736

* cited by examiner

Primary Examiner — Mitchell Siegel

(74) *Attorney, Agent, or Firm* — Kay H. Chin

(57) **CLAIM**

The ornamental design for a golf putter head, as shown and described.

DESCRIPTION

FIG. 1 is a top plan view of a golf putter head showing my new design;

FIG. 2 is a bottom plan view thereof;

FIG. 3 is a front elevational view thereof;

FIG. 4 is a rear elevational view thereof;

FIG. 5 is a left side elevational view thereof;

FIG. 6 is a right side elevational view thereof;

FIG. 7 is a top perspective view thereof;

FIG. 8 is another top perspective view thereof. the broken lines are for illustrative purposes only and form no part of the claimed design;

FIG. 9 is a top plan view of a second embodiment of a golf putter head;

FIG. 10 is a bottom plan view of FIG. 9;

FIG. 11 is a front elevational view of FIG. 9;

FIG. 12 is a rear elevational view of FIG. 9;

FIG. 13 is a left side elevational view of FIG. 9;

FIG. 14 is a right side elevational view of FIG. 9;

FIG. 15 is a top perspective view of FIG. 9;

FIG. 16 is another top perspective of FIG. 9, the broken lines are for illustrative purposes only and form no part of the claimed design;

FIG. 17 is a top plan view of a third embodiment of a golf putter head;

FIG. 18 is a bottom plan view of FIG. 17;

FIG. 19 is a front elevational view of FIG. 17;

FIG. 20 is a rear elevational view of FIG. 17;

FIG. 21 is a left side elevational view of FIG. 17;

FIG. 22 is a right side elevational view of FIG. 17;

FIG. 23 is a top perspective view of FIG. 17; and,

FIG. 24 is another top perspective view of FIG. 17, the broken lines are for illustrative purposes only and form no part of the claimed design.

1 Claim, 12 Drawing Sheets

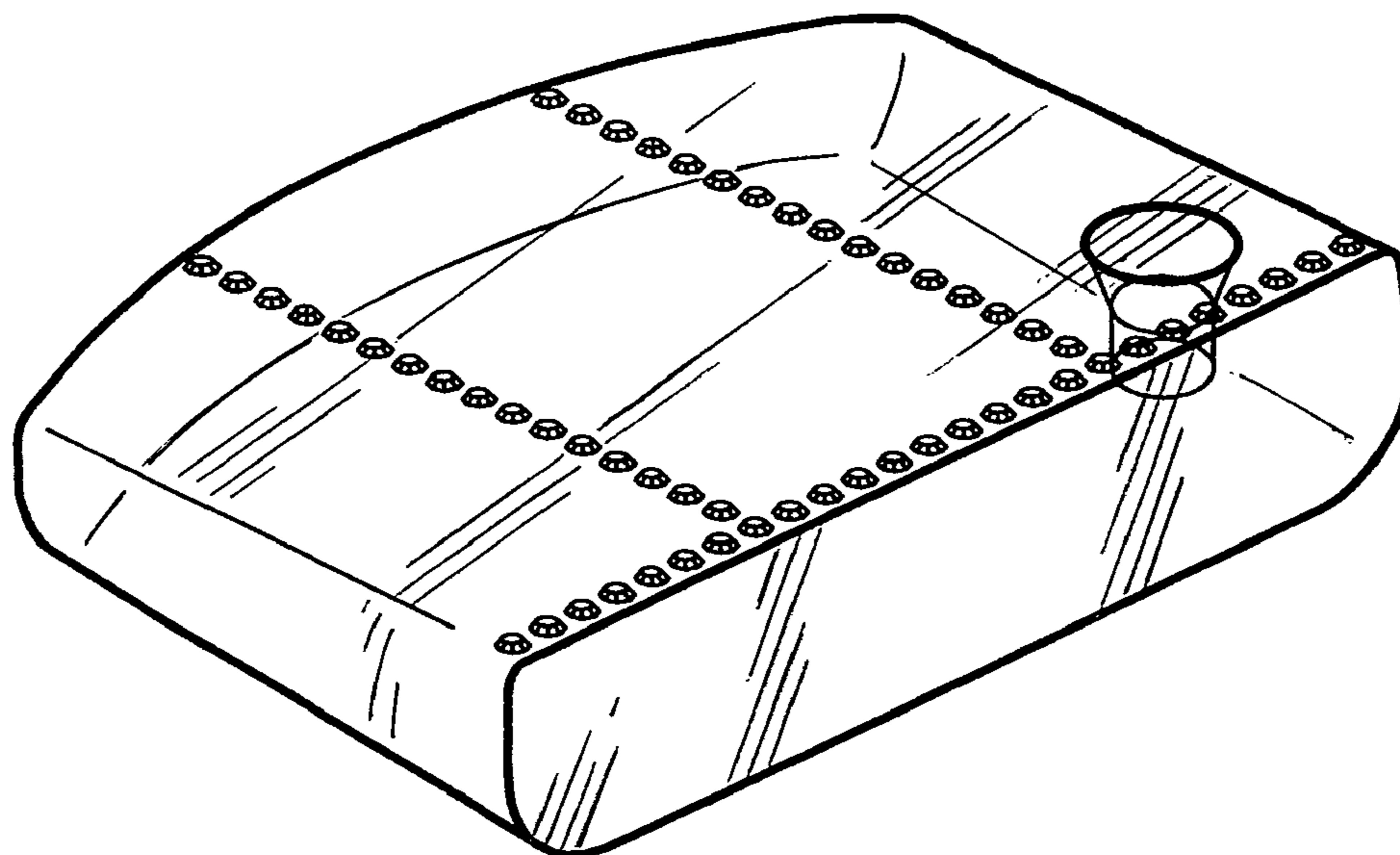

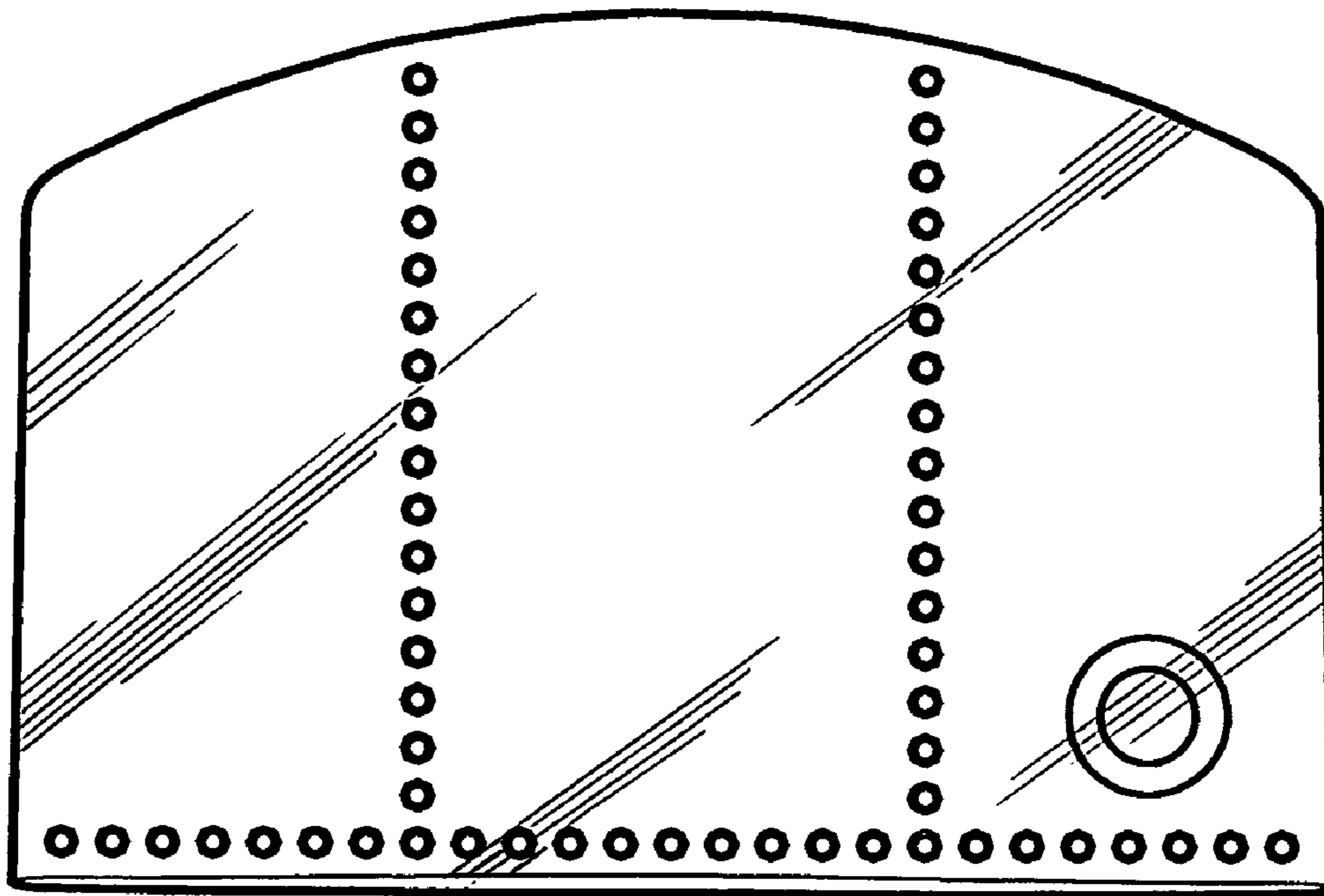

Fig 1

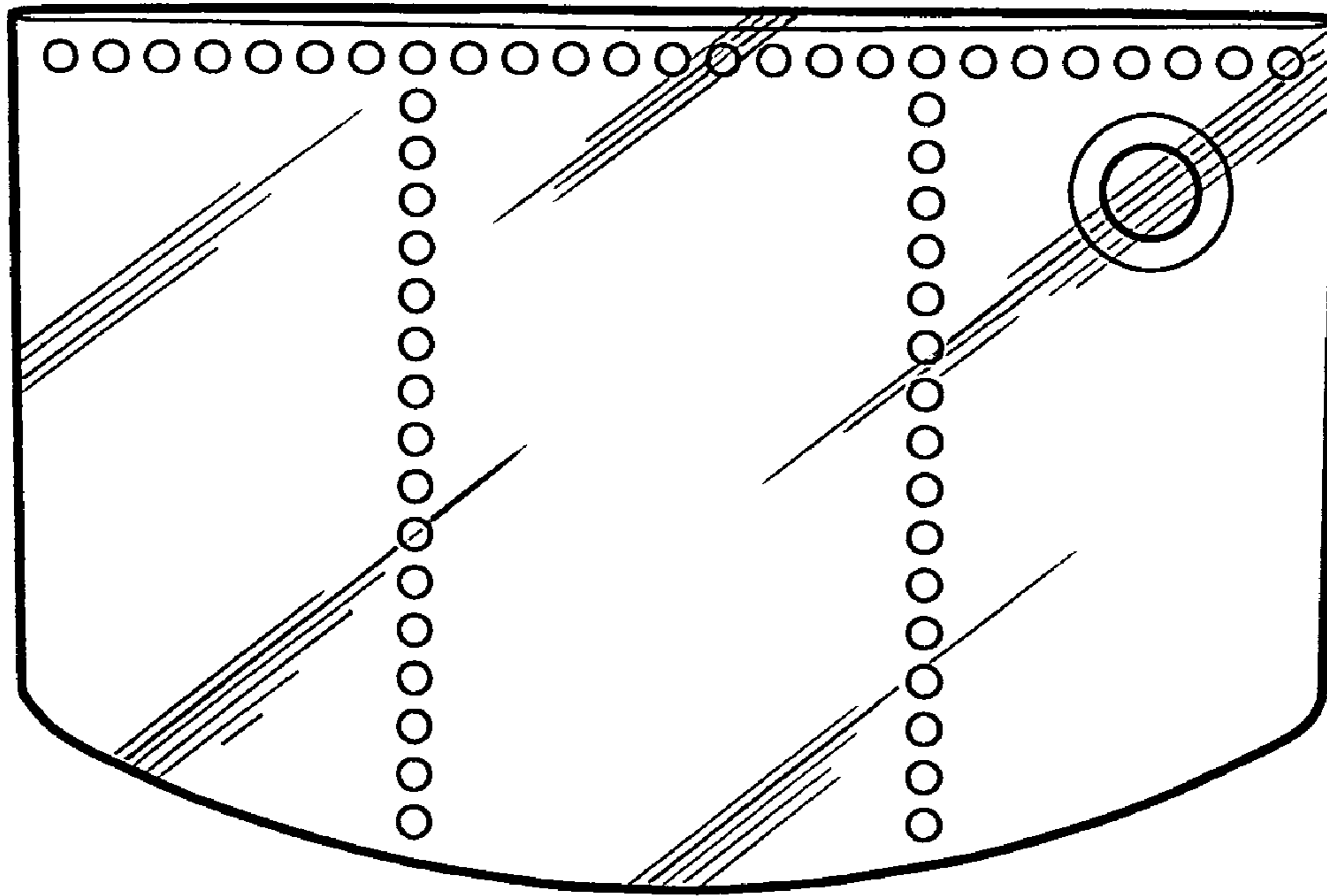

Fig 2

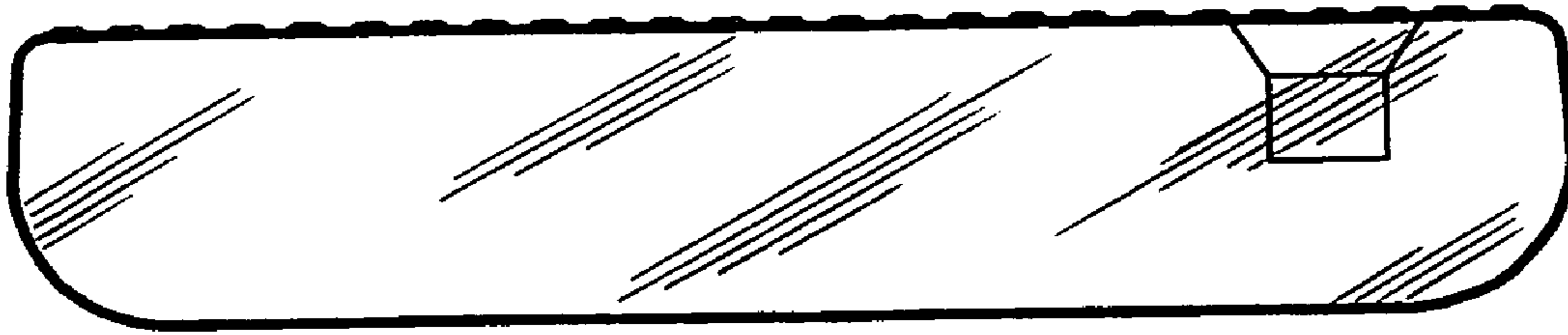

Fig 3



Fig 4

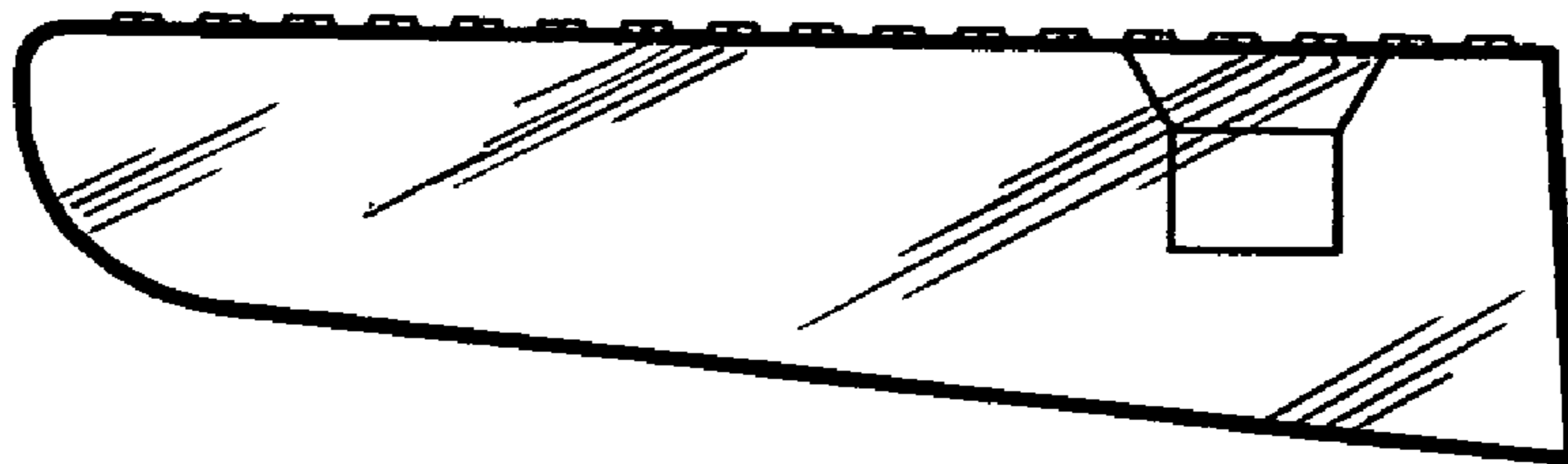

Fig 5

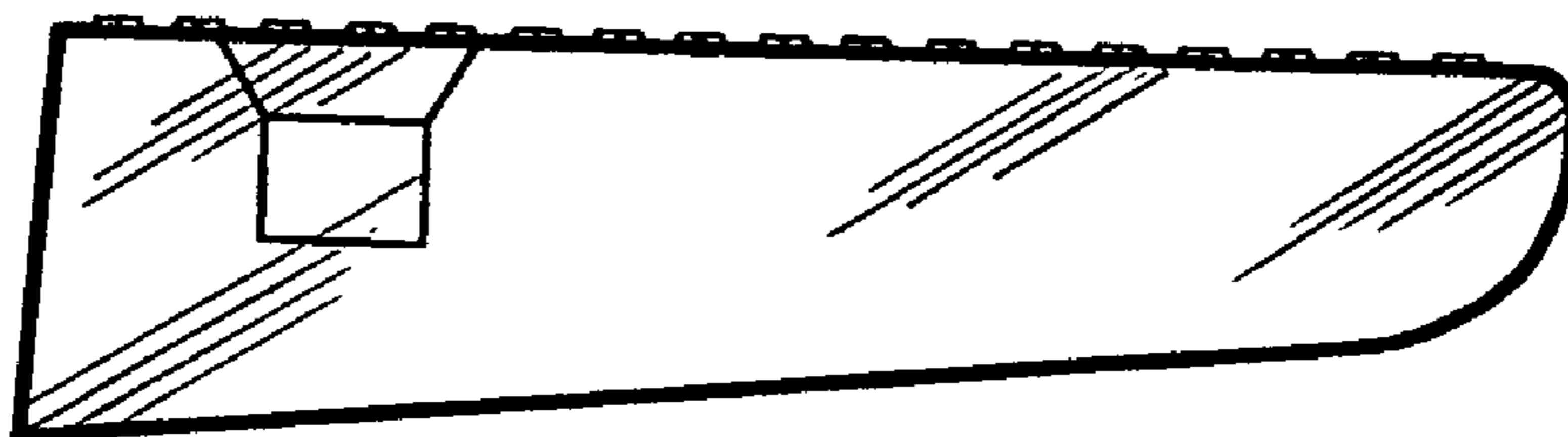

Fig 6

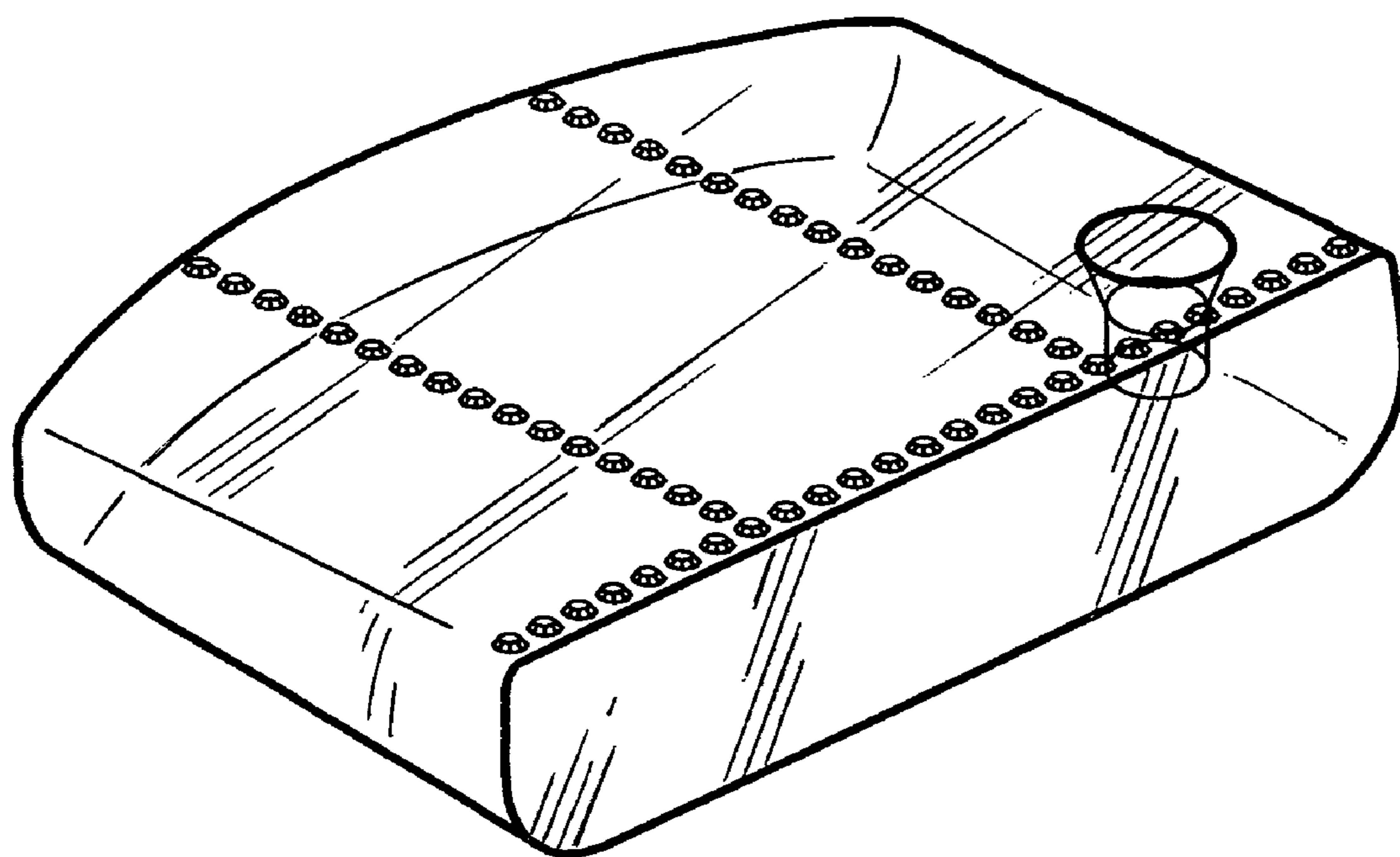

Fig 7

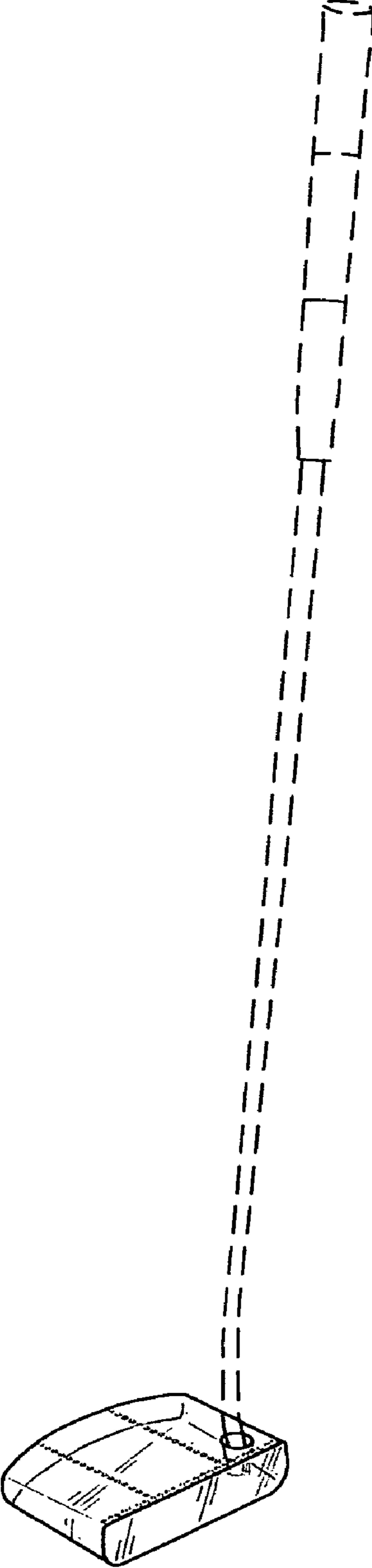

Fig 8

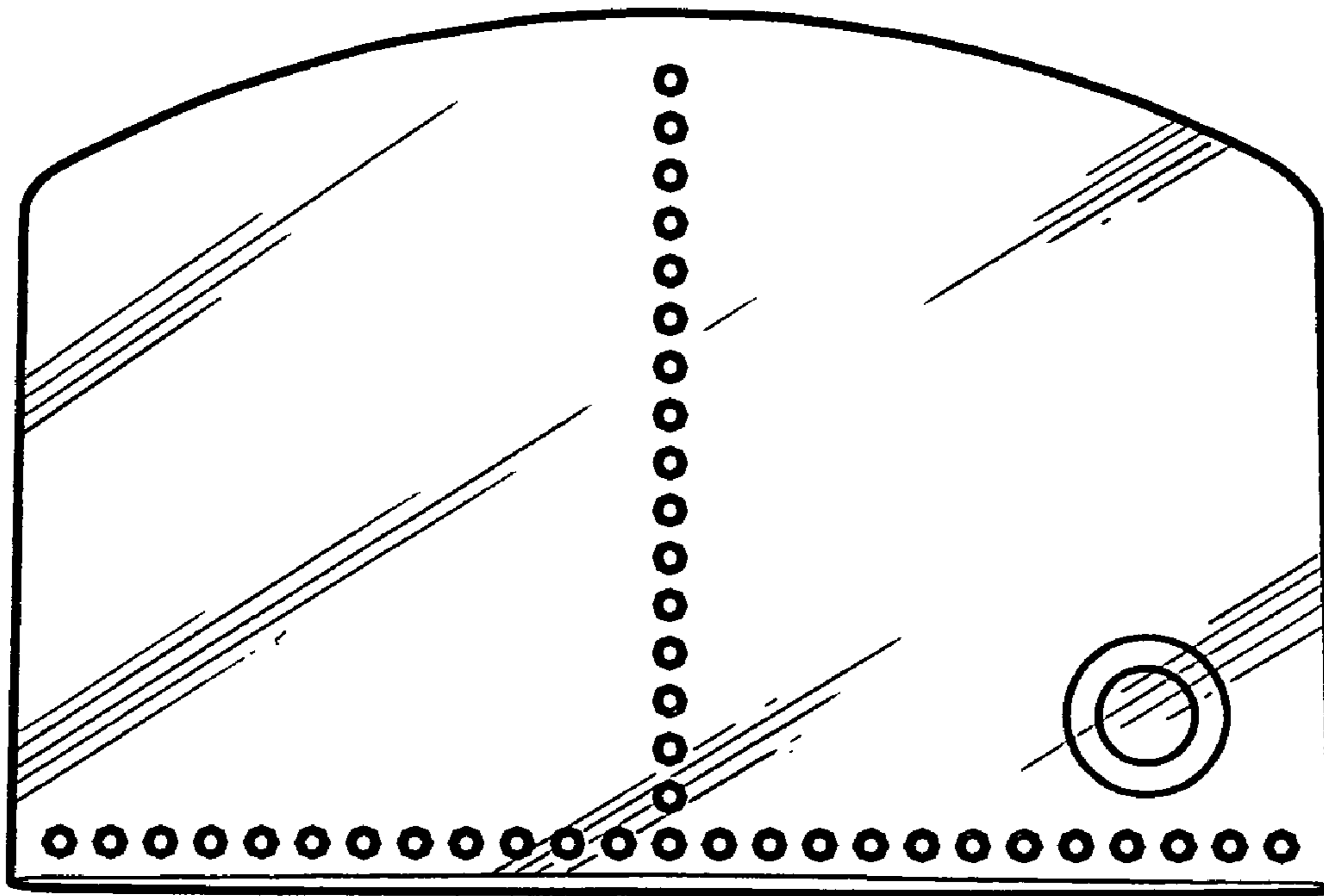

Fig 9

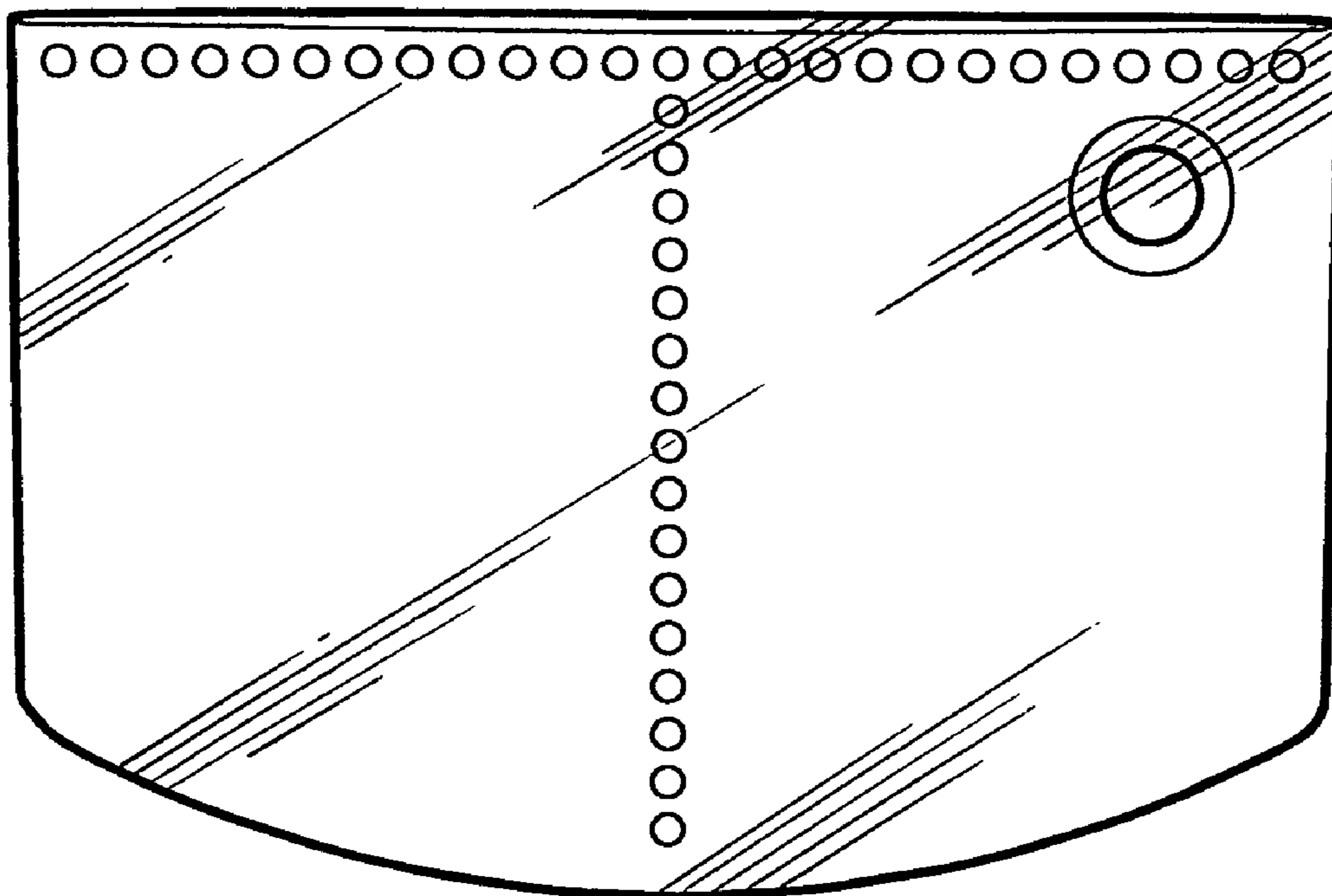

Fig 10

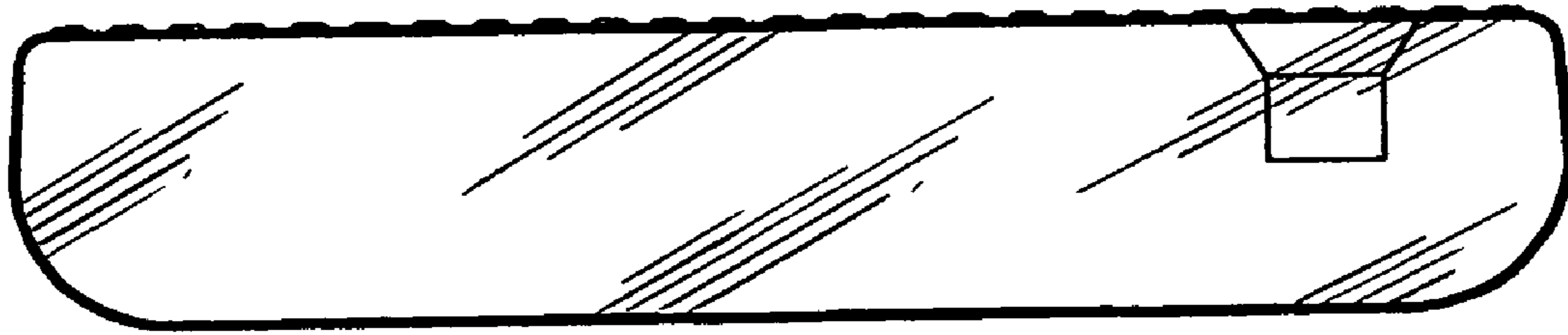

Fig 11



Fig 12

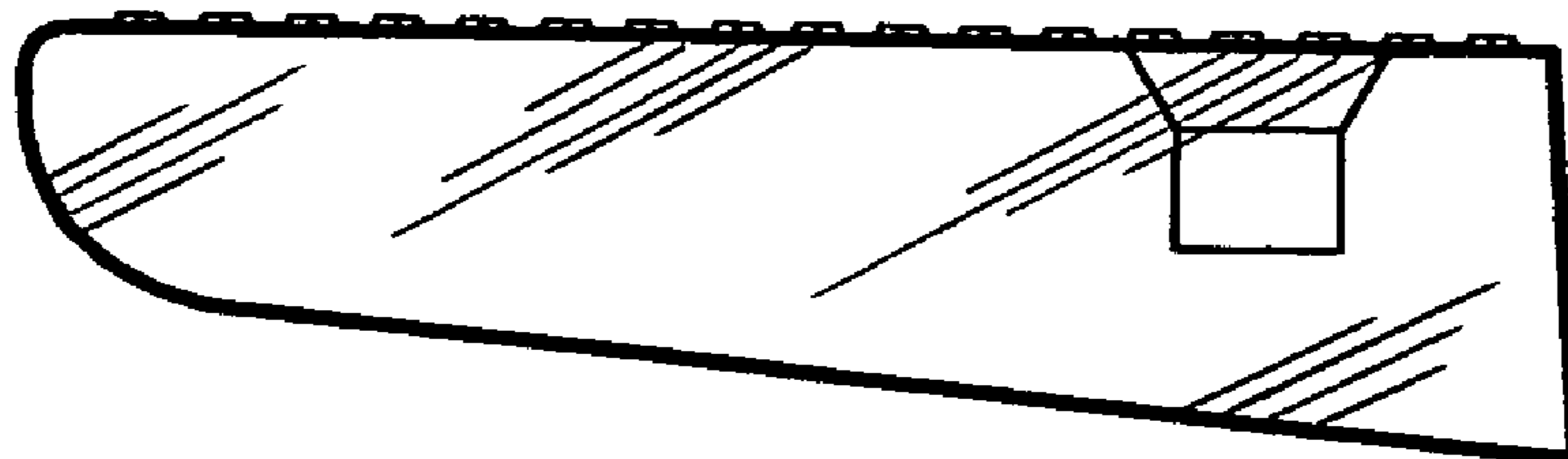

Fig 13

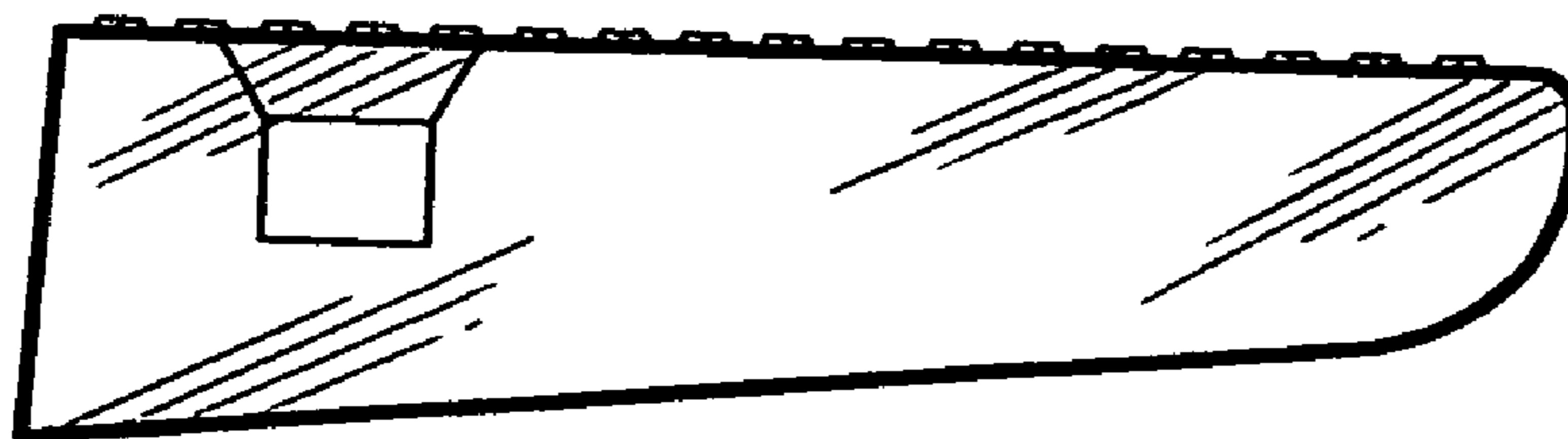

Fig 14

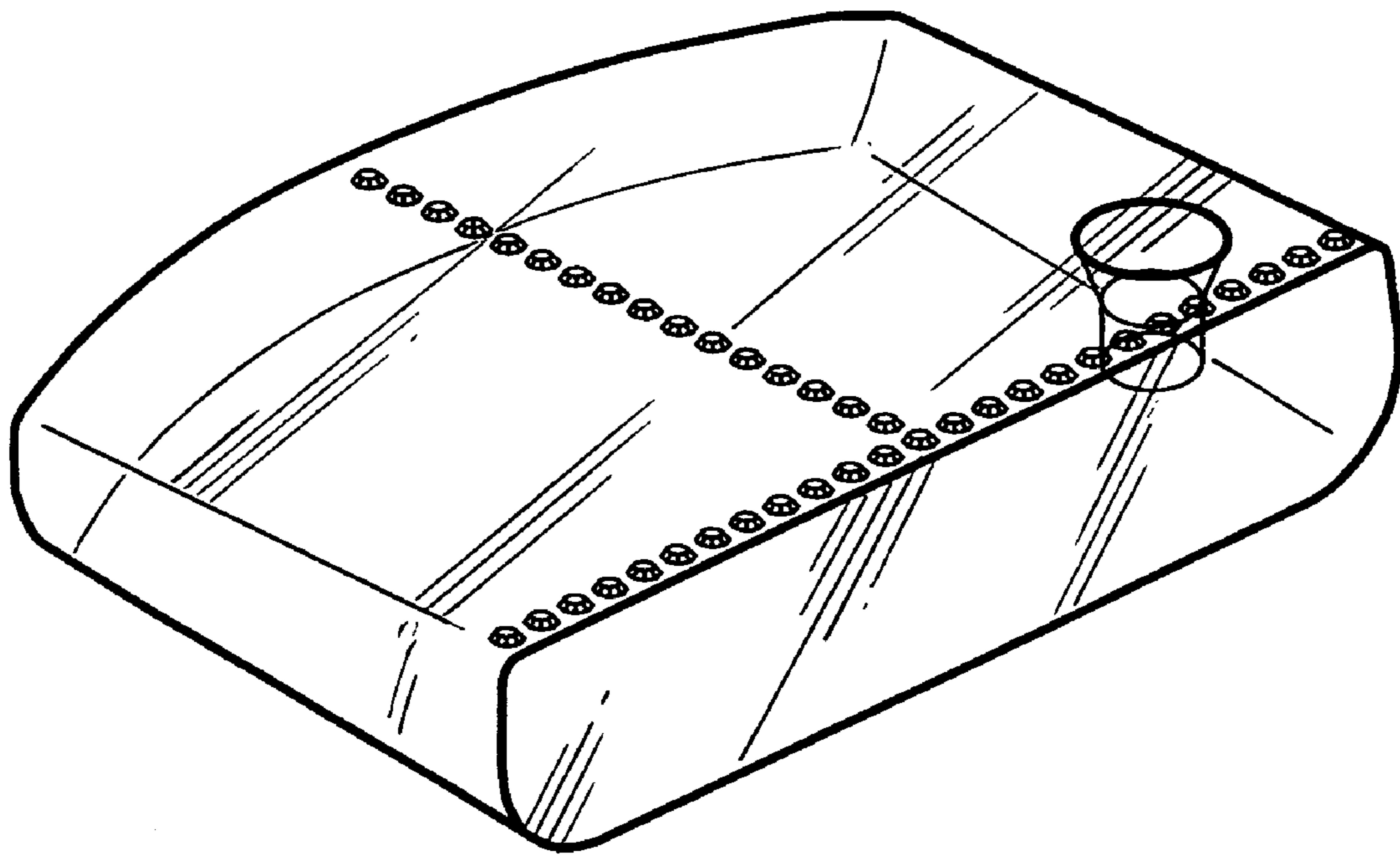

Fig 15

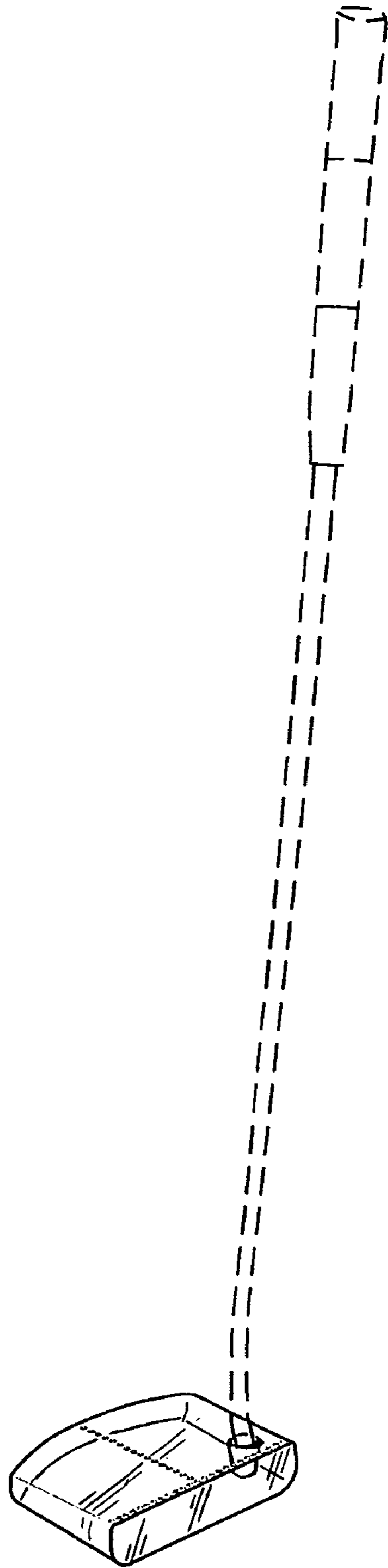

Fig 16

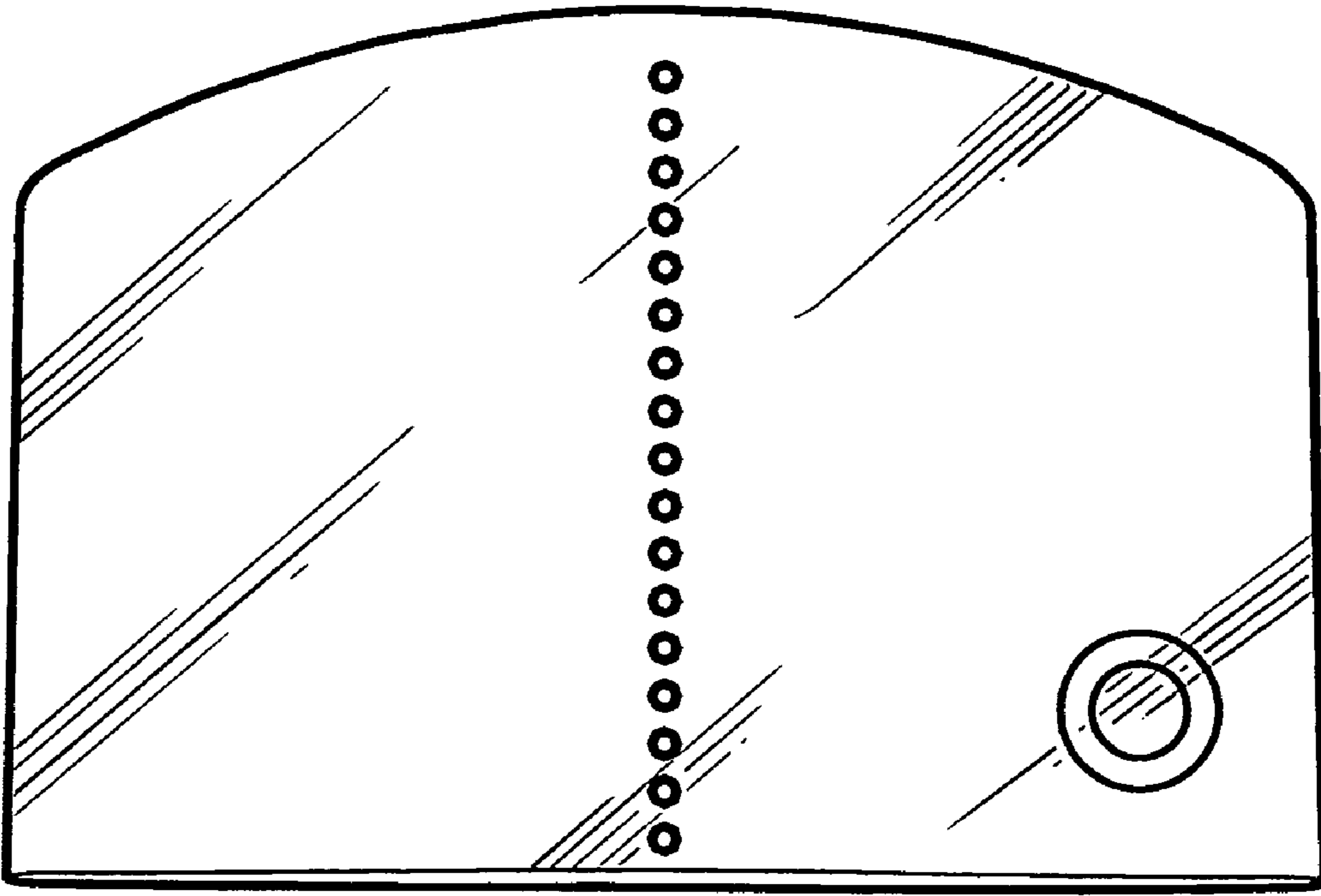

Fig 17

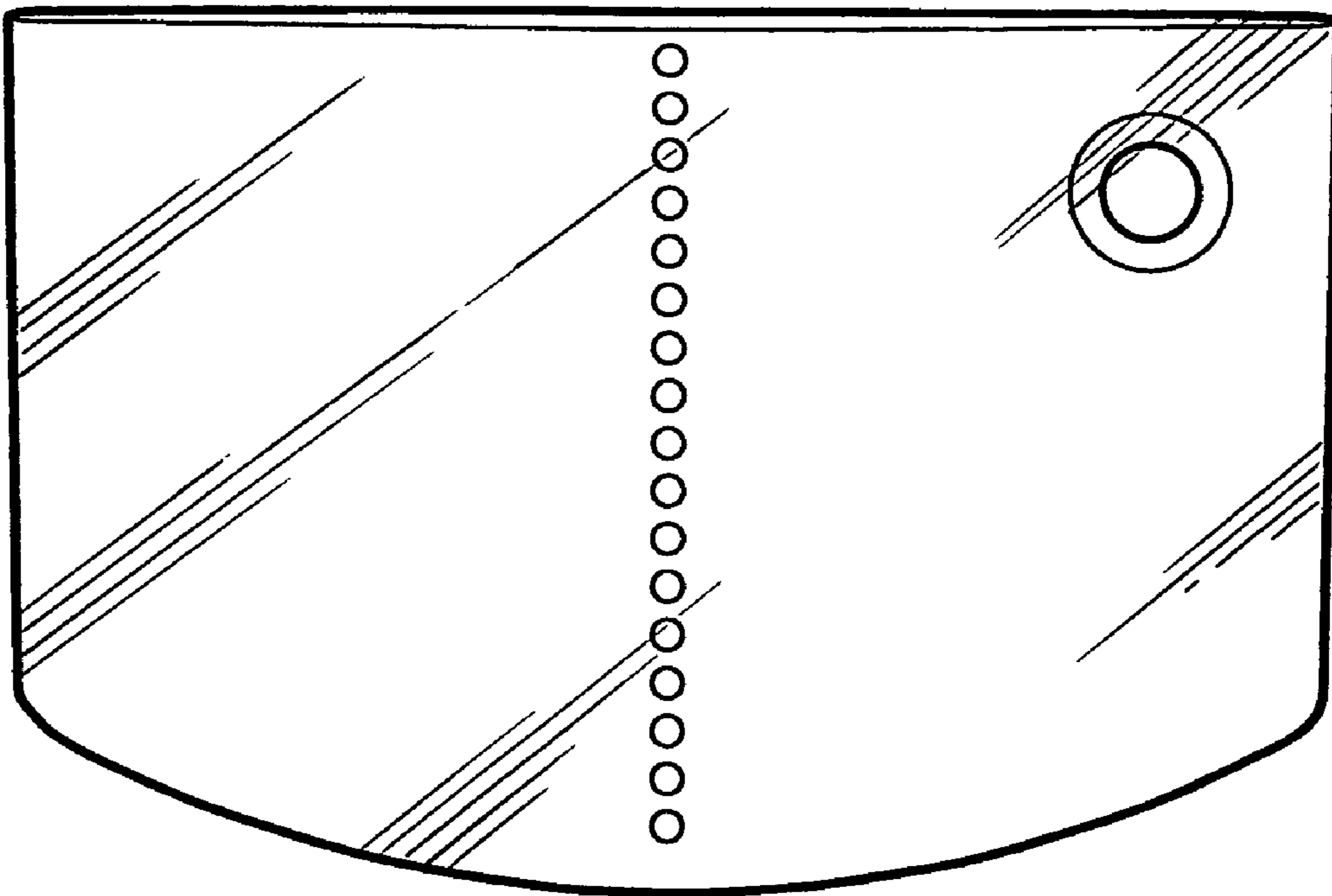

Fig 18

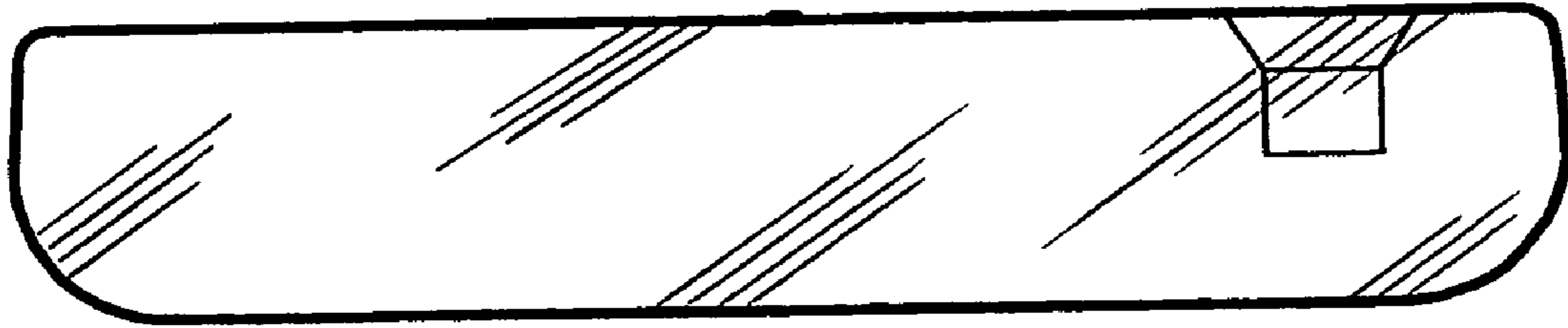

Fig 19



Fig 20

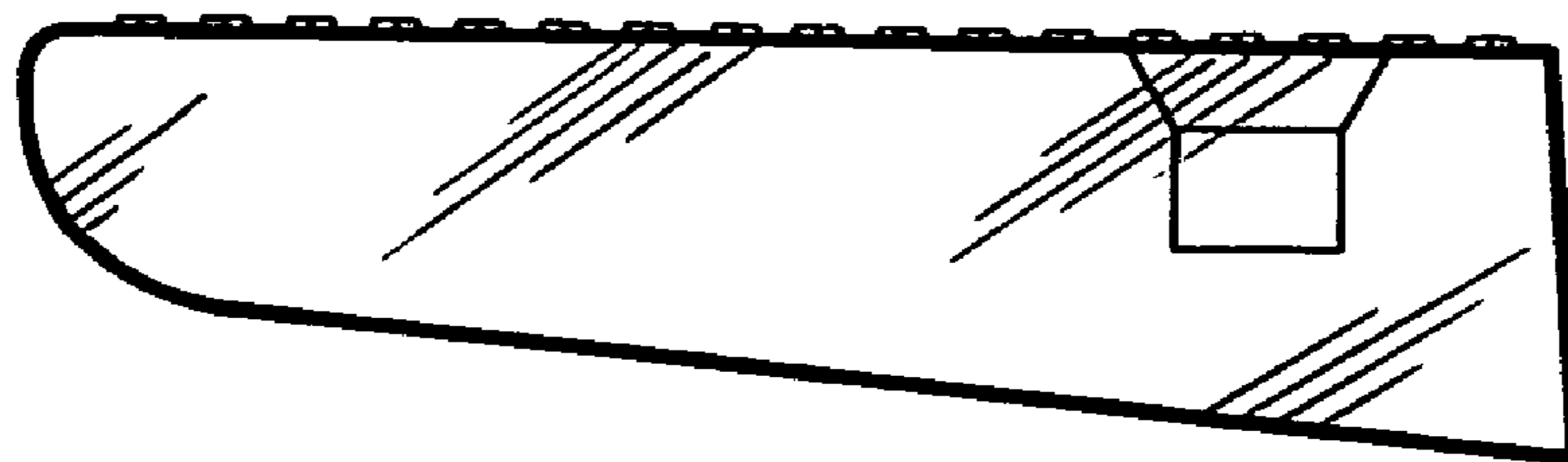

Fig 21

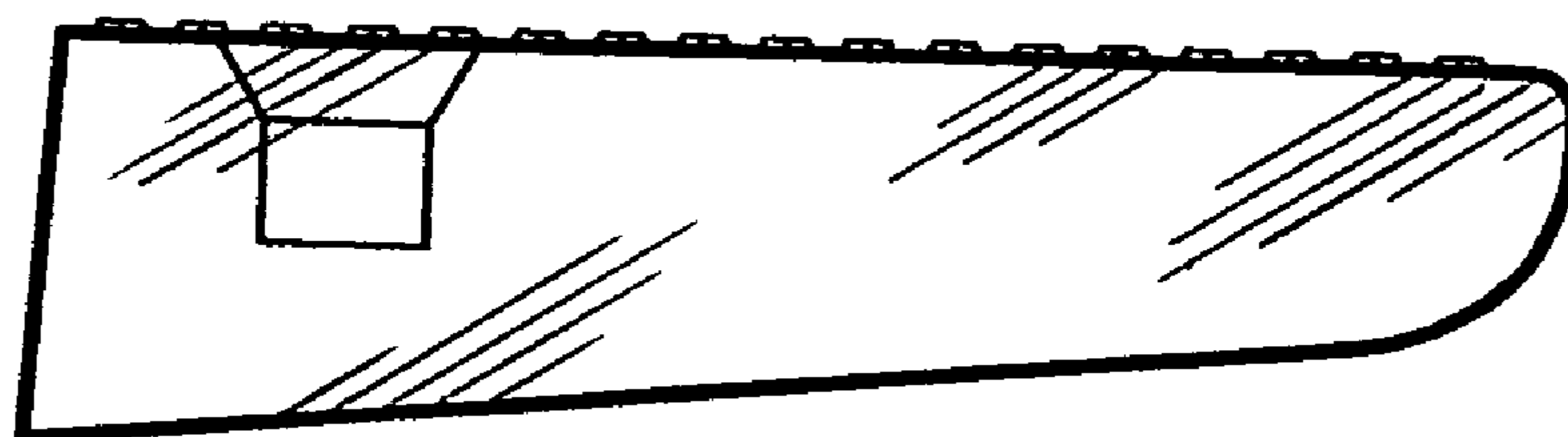

Fig 22

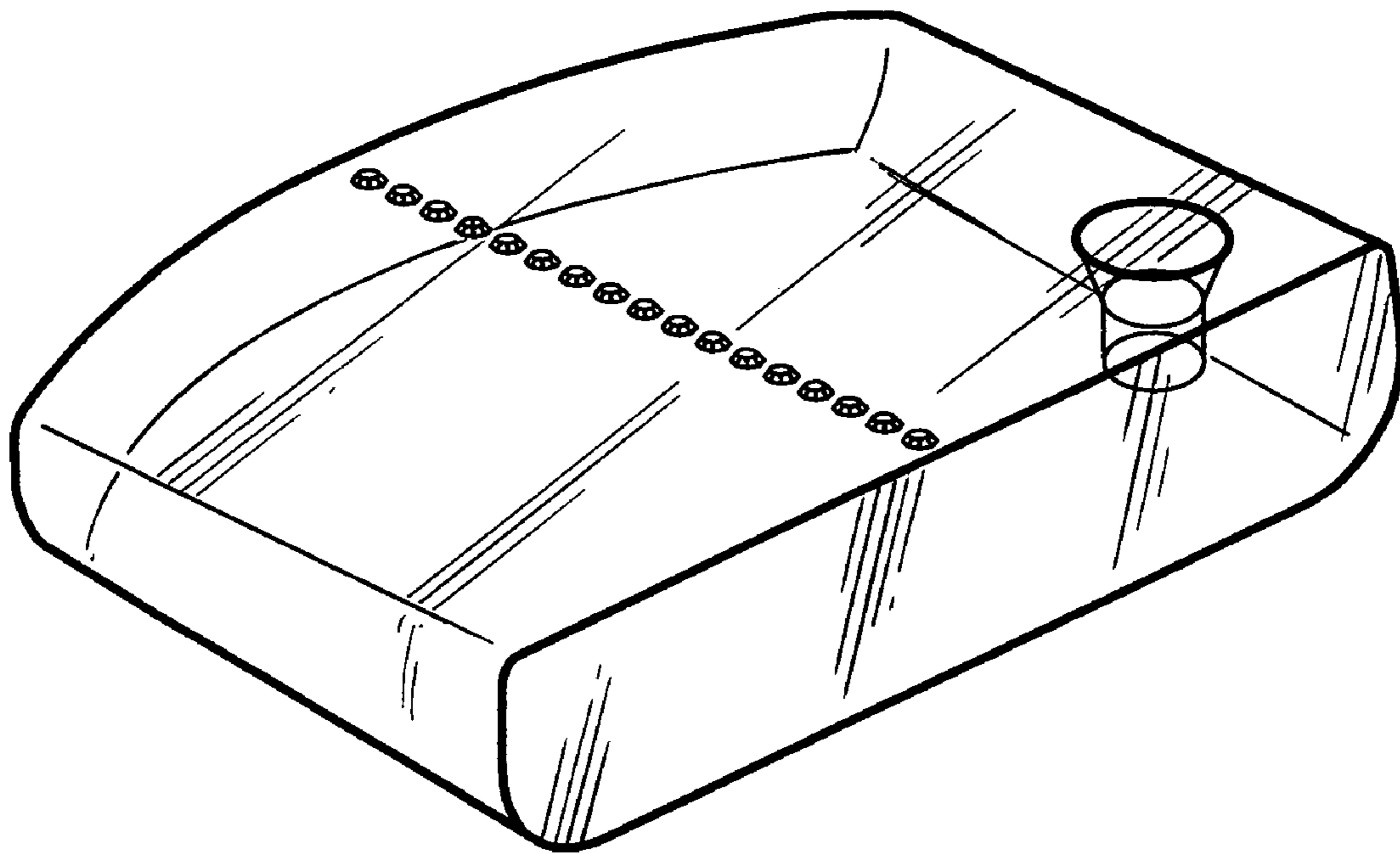

Fig 23

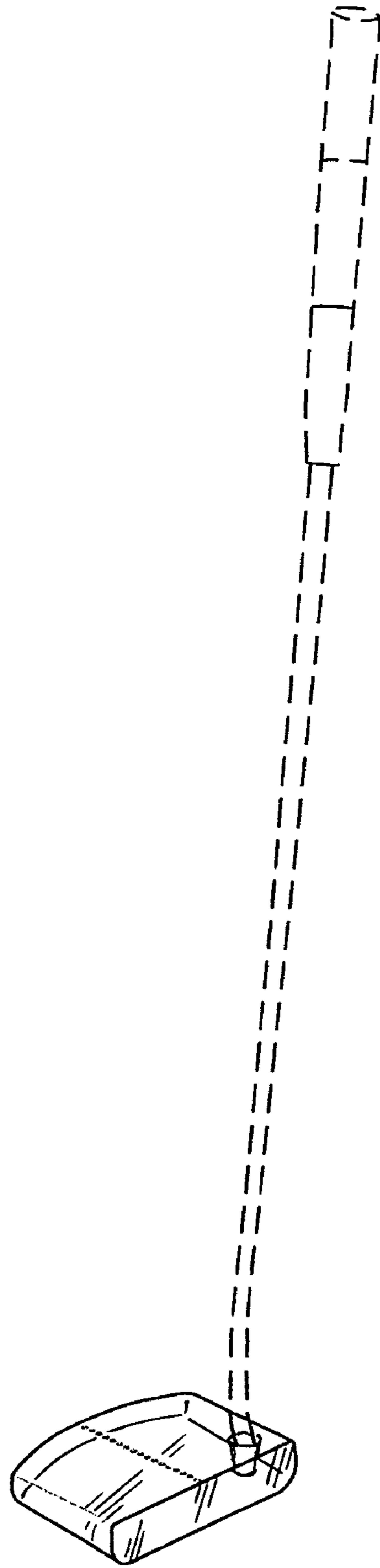

Fig 24