



US00D666251S

(12) **United States Design Patent**
Yanagita

(10) **Patent No.:** **US D666,251 S**

(45) **Date of Patent:** **** Aug. 28, 2012**

(54) **BOARD GAME**

(76) Inventor: **Roger Yanagita**, Los Angeles, CA (US)

(**) Term: **14 Years**

(21) Appl. No.: **29/380,993**

(22) Filed: **Dec. 14, 2010**

(51) **LOC (9) Cl.** **21-01**

(52) **U.S. Cl.** **D21/335; D21/363; D21/393**

(58) **Field of Classification Search** D21/334–369,
D21/385, 392–397; 273/236–288, 148 R
See application file for complete search history.

(56) **References Cited**

U.S. PATENT DOCUMENTS

D124,909 S *	1/1941	Walker	D21/341
3,843,130 A *	10/1974	Whitney, Jr.	273/261
D243,544 S *	3/1977	Hope	D21/361
D250,133 S *	10/1978	Azbill et al.	D21/349
D301,346 S *	5/1989	Sjostrand et al.	D21/335
4,925,194 A *	5/1990	Anderson	273/271
5,586,762 A *	12/1996	Wearley	273/261
D499,772 S *	12/2004	Creech	D21/385

* cited by examiner

Primary Examiner — Sandra Morris

(74) *Attorney, Agent, or Firm* — QuickPatents, Inc.; Kevin Prince

(57) **CLAIM**

The ornamental design for a board game, as shown and described.

DESCRIPTION

FIG. 1 is a perspective view of a board game, showing the new design in a packed configuration;

FIG. 2 is an exploded perspective view thereof, showing a game board removed from a packaging tray;

FIG. 3 is a top plan view of the game board in an unfolded configuration;

FIG. 4 is a front elevational view of FIG. 3, the rear elevational view being a mirror image thereof;

FIG. 5 is a left-side elevational view of FIG. 3, the right-side elevational view being a mirror image thereof;

FIG. 6 is a rear elevational view thereof;

FIG. 7 is a top plan view of the packaging tray;

FIG. 8 is a bottom plan view of FIG. 7;

FIG. 9 is a left-side elevational view of FIG. 7, the right-side elevational view being a mirror image thereof; and,

FIG. 10 is a front elevational view of FIG. 7, the rear elevational view being a mirror image thereof.

1 Claim, 3 Drawing Sheets

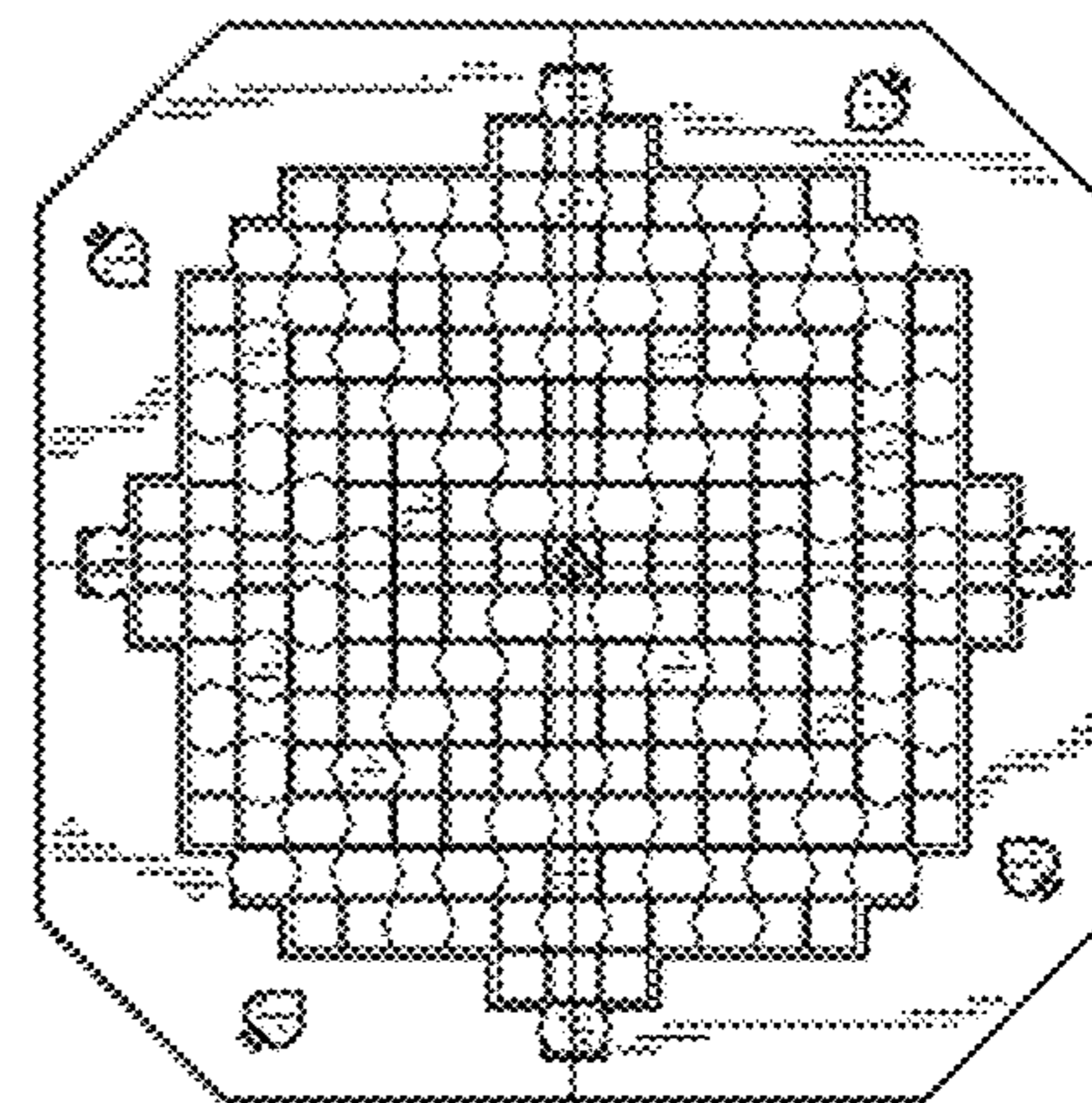
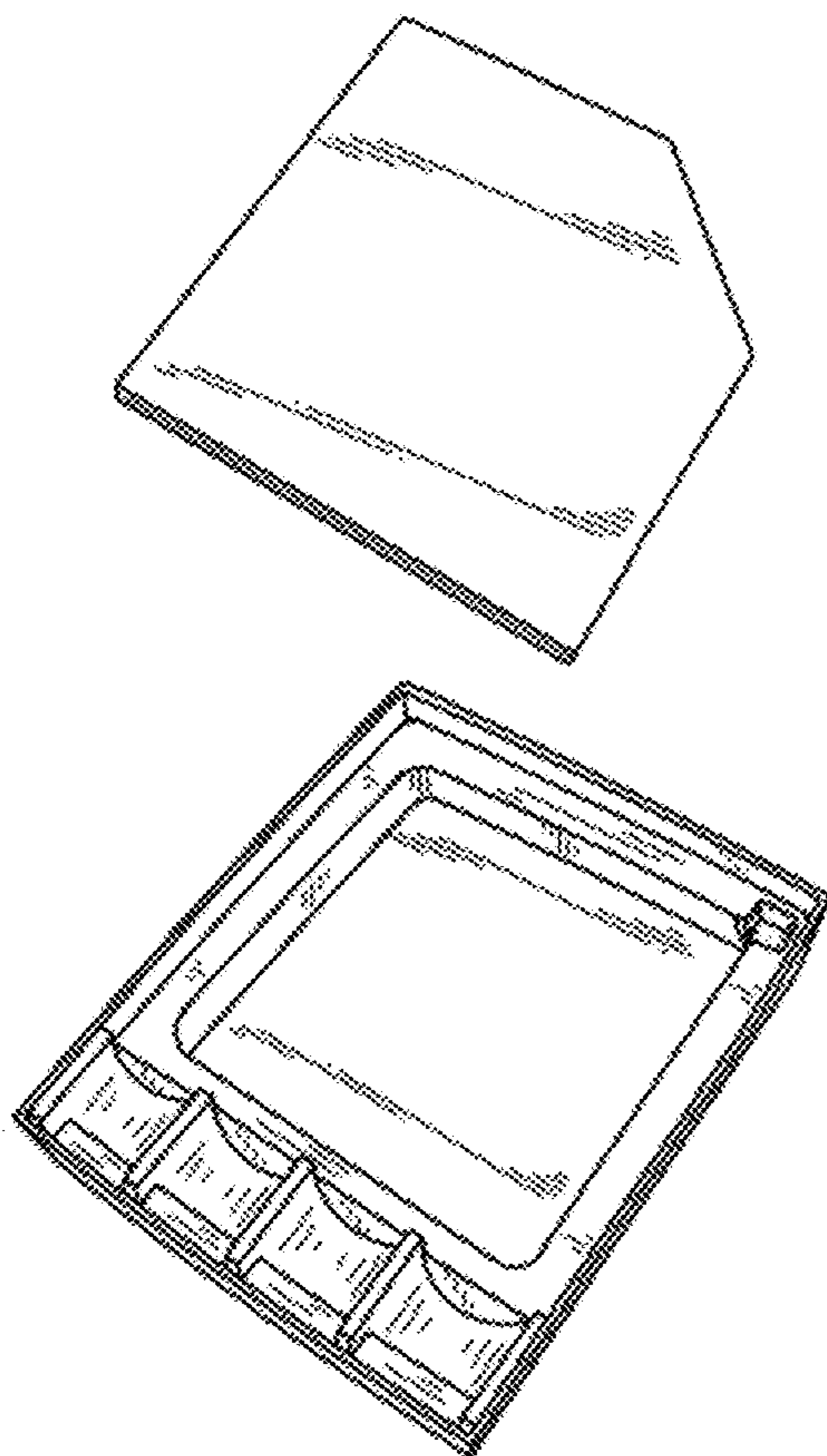

FIG. 1

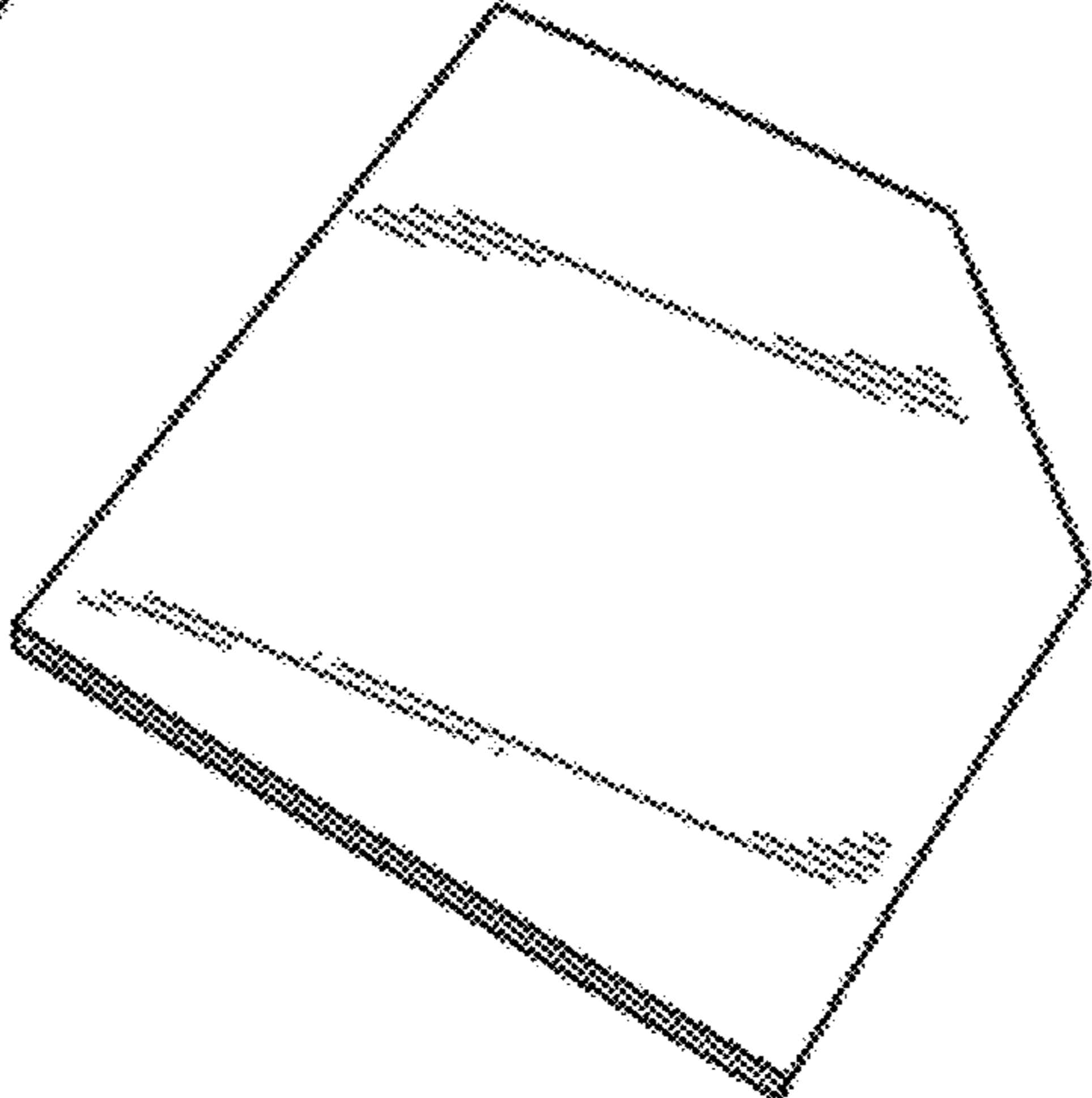
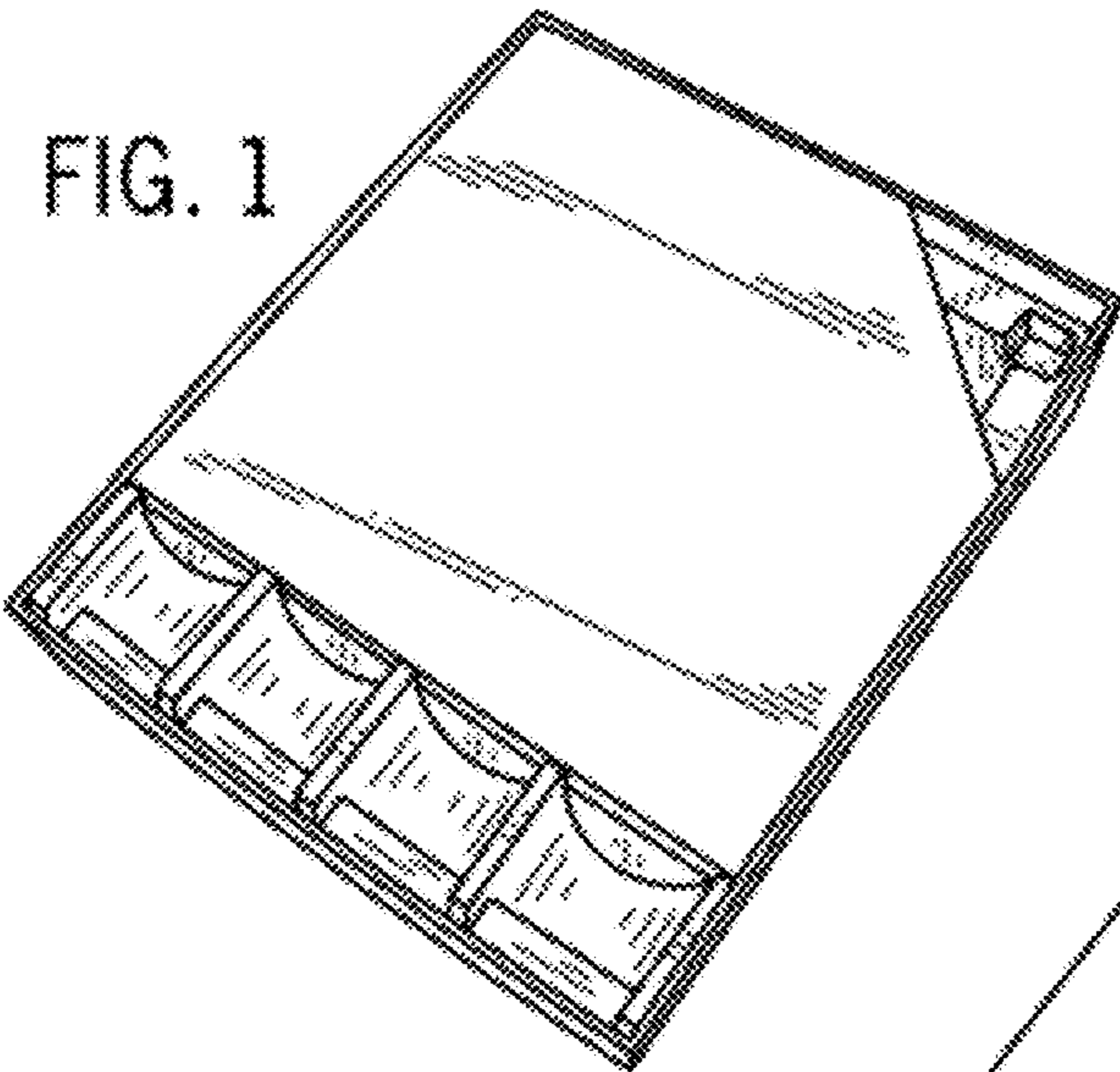

FIG. 2

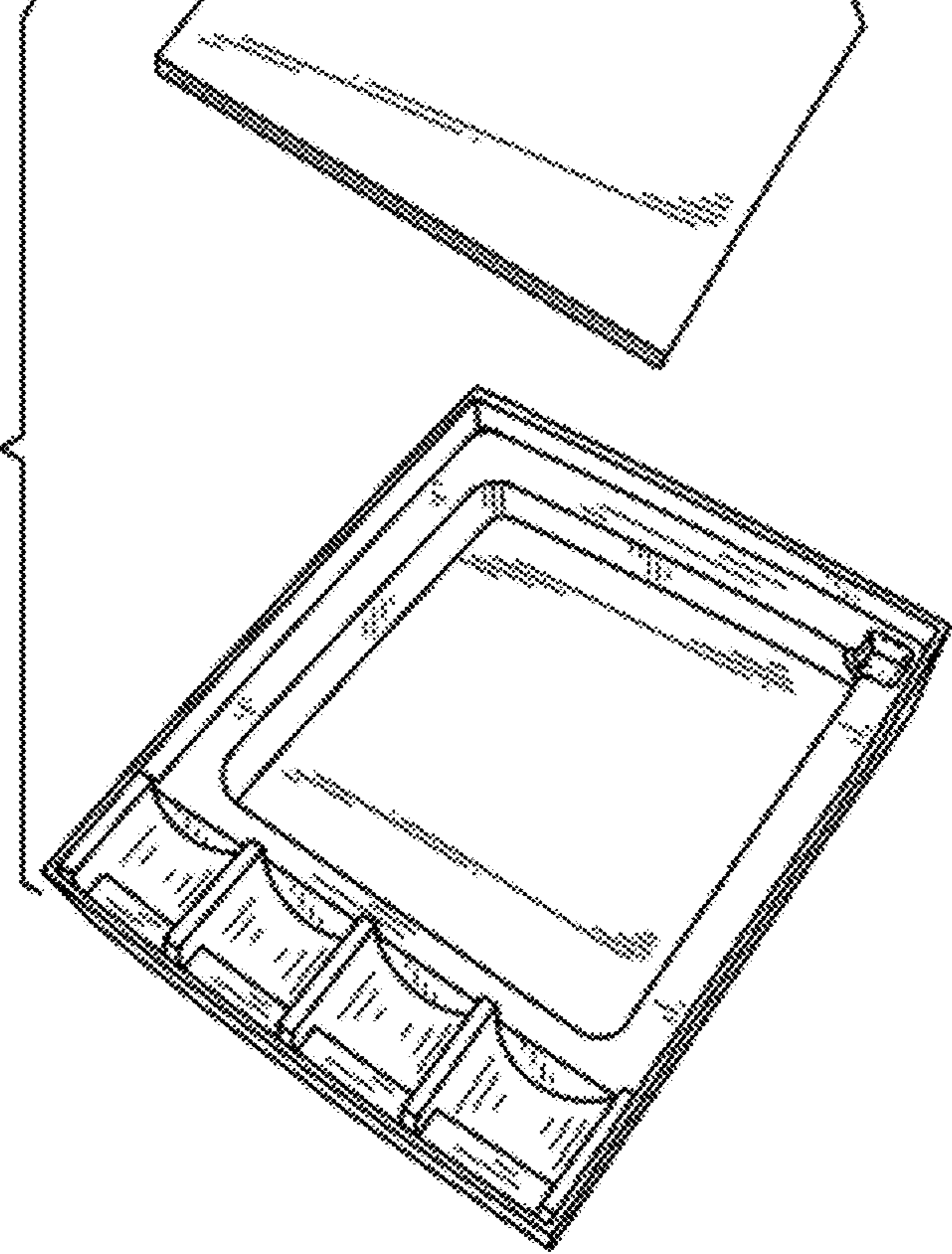

FIG. 3

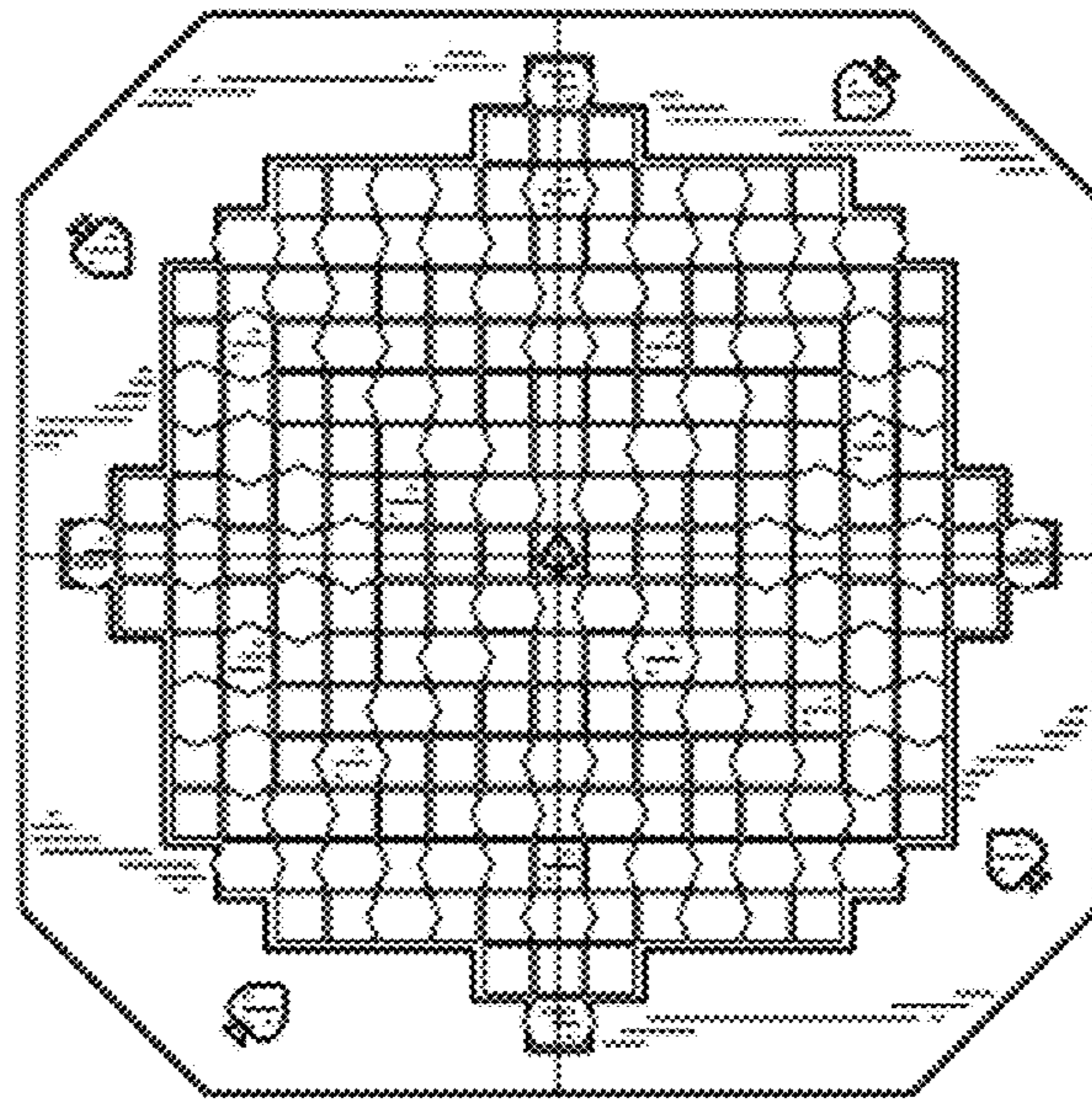

FIG. 4

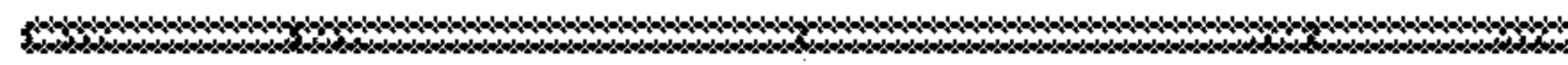

FIG. 5

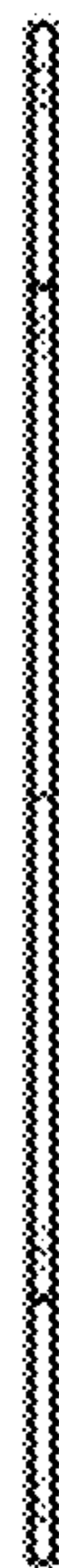

FIG. 6

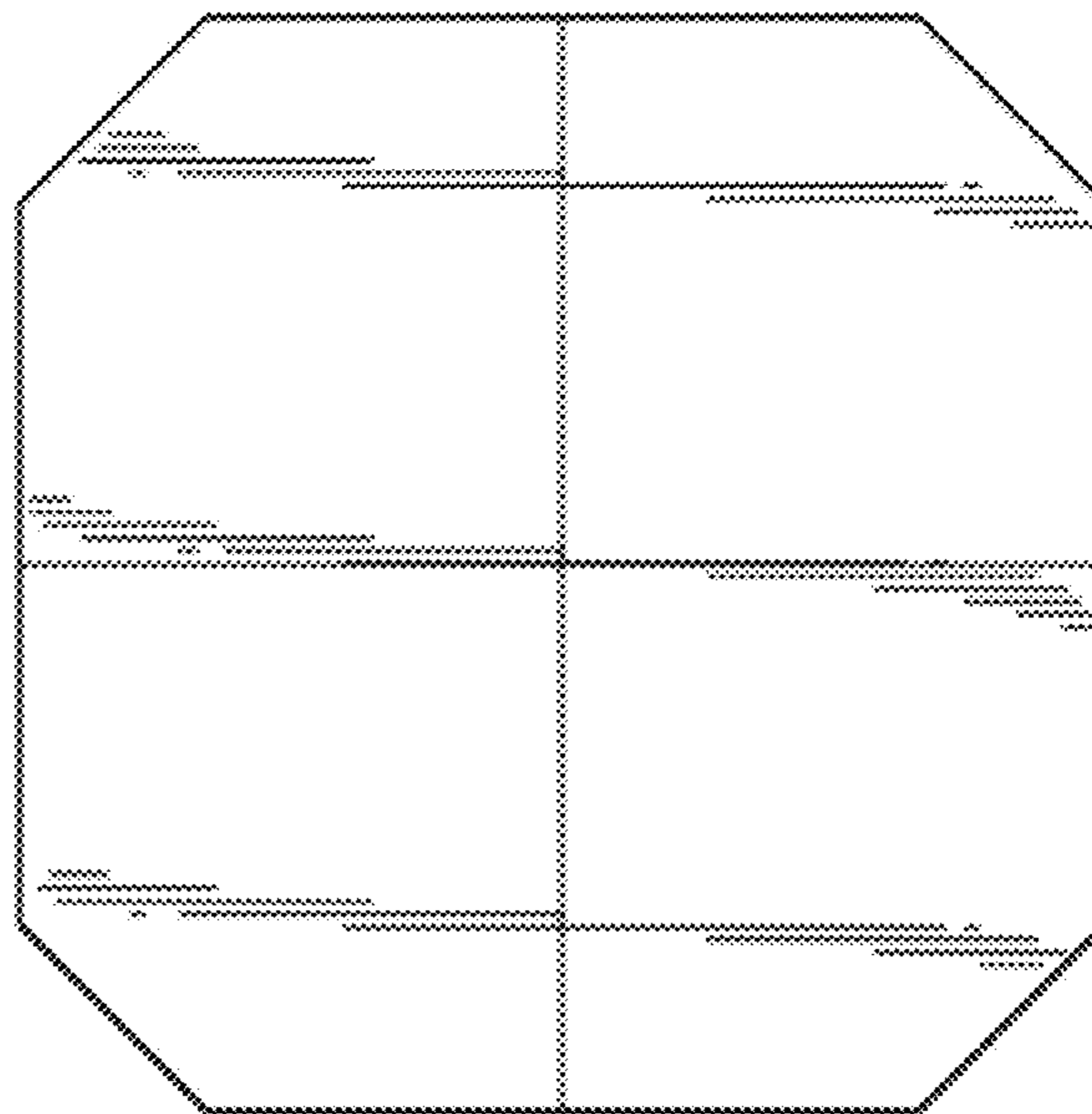

FIG. 7

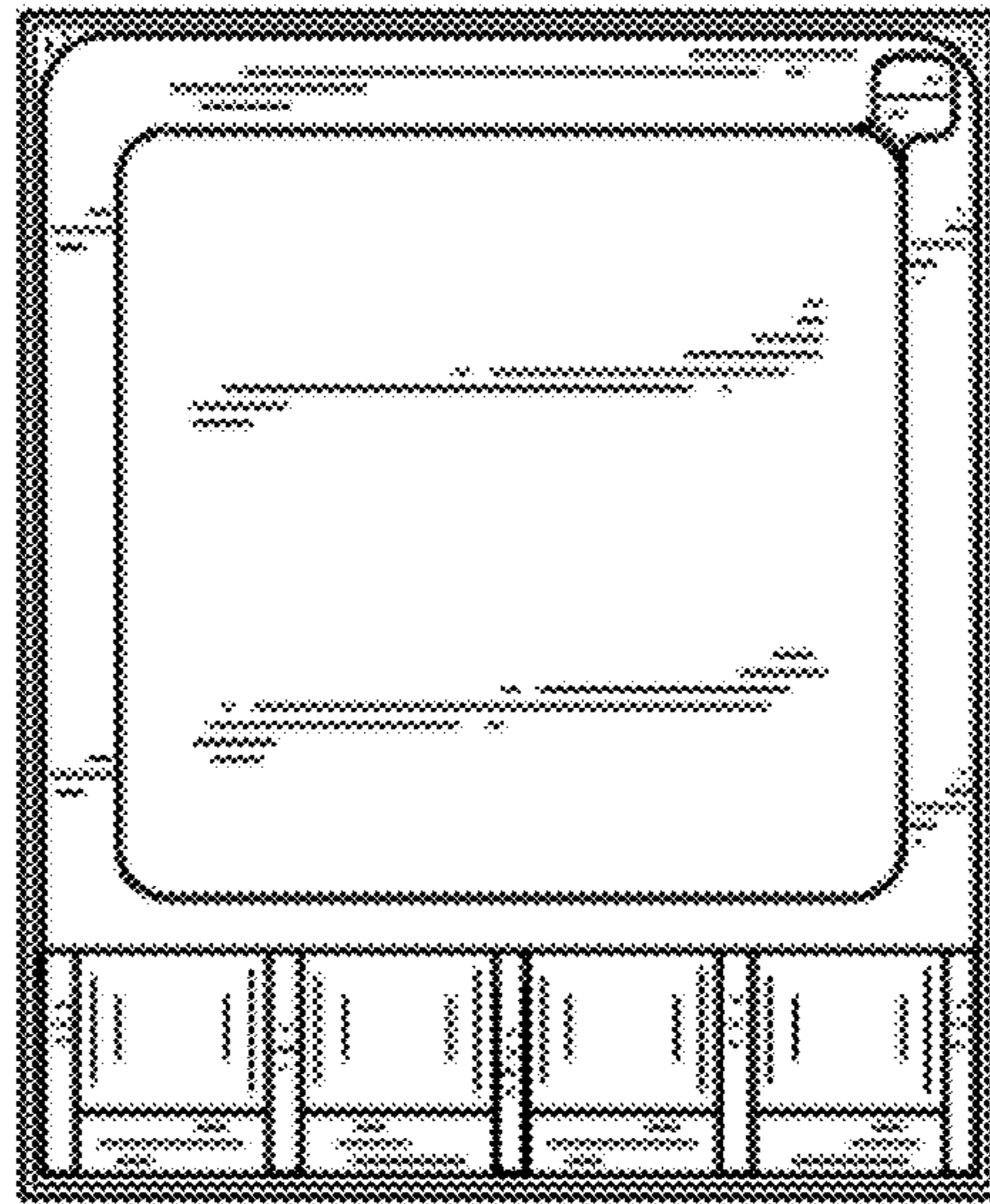

FIG. 8

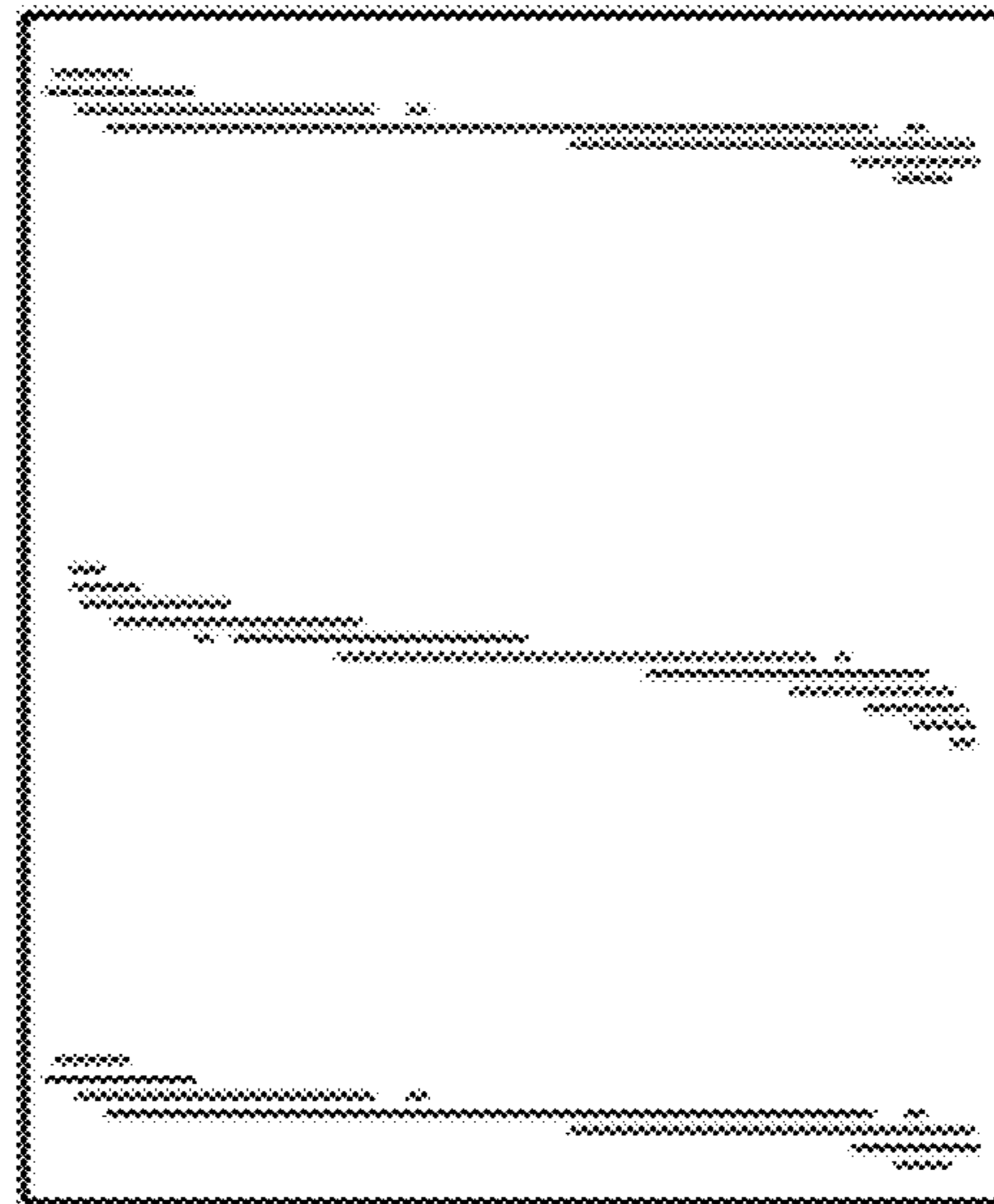

FIG. 9



FIG. 10

