



US00D666213S

(12) **United States Design Patent**  
**Fahrberger et al.**

(10) **Patent No.:** **US D666,213 S**

(45) **Date of Patent:** **\*\* \*Aug. 28, 2012**

(54) **PORTABLE ELECTRONIC MEDIA HOLDER WITH PLUSH ANIMAL**

(76) Inventors: **Beatriz Fahrberger**, Tracy, CA (US);  
**Louis Fahrberger**, Tracy, CA (US)

(\*) Notice: This patent is subject to a terminal disclaimer.

(\*\*) Term: **14 Years**

(21) Appl. No.: **29/351,982**

(22) Filed: **Dec. 15, 2009**

(51) **LOC (9) Cl.** ..... **14-03**

(52) **U.S. Cl.** ..... **D14/496**

(58) **Field of Classification Search** ..... D14/496,  
D14/497, 435, 463, 217, 168, 137, 138, 160,  
D14/432, 434, 203.2; 345/156, 169, 173-179,  
345/903; 455/11.1, 7.73, 344-351, 93-95;  
370/342-344; 369/1, 2, 6, 12; 463/43-47;  
273/148 B; D21/604, 605

See application file for complete search history.

(56) **References Cited**

U.S. PATENT DOCUMENTS

D360,207 S *	7/1995	Grasso et al. ....	D14/165
D384,103 S *	9/1997	Chuang .....	D19/42
D465,646 S *	11/2002	Hendrickson .....	D3/218
D565,126 S *	3/2008	Fong et al. ....	D21/605
D582,894 S *	12/2008	Richter .....	D14/217
7,505,583 B2 *	3/2009	Rohrbach .....	379/455
D592,188 S *	5/2009	Huang .....	D14/217

D604,744 S *	11/2009	Tseng et al. ....	D14/496
7,611,114 B1 *	11/2009	Griffin .....	248/311.2
7,828,259 B2 *	11/2010	Wang et al. ....	248/316.4
7,913,961 B2 *	3/2011	Del Frari .....	248/205.1
7,930,006 B2 *	4/2011	Neu et al. ....	455/575.1

\* cited by examiner

*Primary Examiner* — Prabhakar Deshmukh

(57) **CLAIM**

The ornamental design for a portable electronic media holder with plush animal, as shown and described.

**DESCRIPTION**

Portions of the disclosure of this patent document contain material that is subject to copyright protection. The copyright owner has no objection to the facsimile reproduction by anyone of the patent document or the patent disclosure as it appears in the Patent and Trademark Office file or records, but otherwise reserves all copyright rights whatsoever.

FIG. 1 is a right perspective view of a portable electronic media holder with plush animal showing our new design;

FIG. 2 is a rear elevational view thereof;

FIG. 3 is a left perspective view thereof;

FIG. 4 is a front elevational view thereof, with hands shown in an extended position and exposing the electronic device;

FIG. 5 is an enlarged partial front elevational view thereof; and,

FIG. 6 is another enlarged partial front elevational view thereof, shown with the arm and pocket.

The broken lines showing of human hand is for illustrative purpose only and forms no part of the claimed design.

**1 Claim, 6 Drawing Sheets**

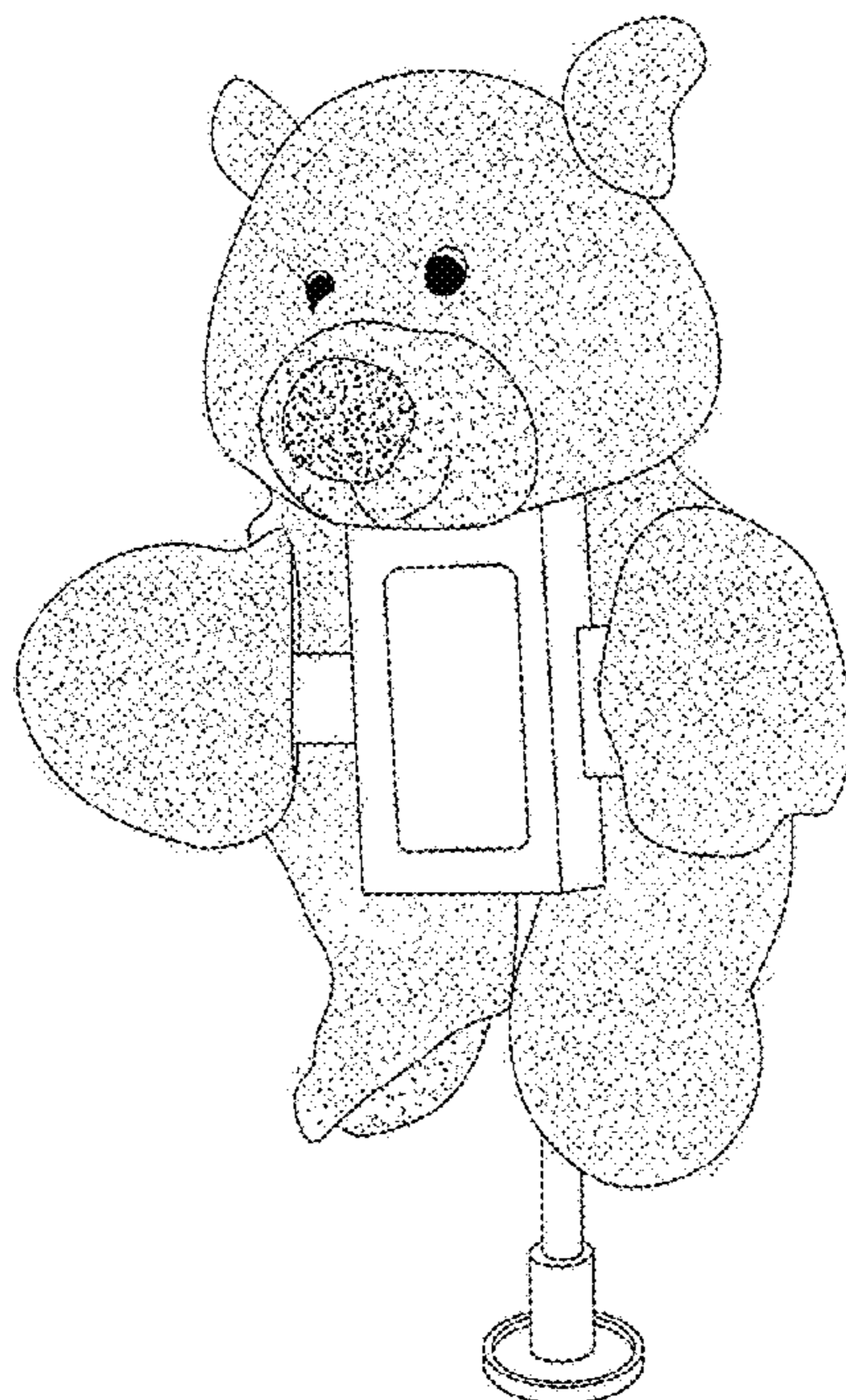

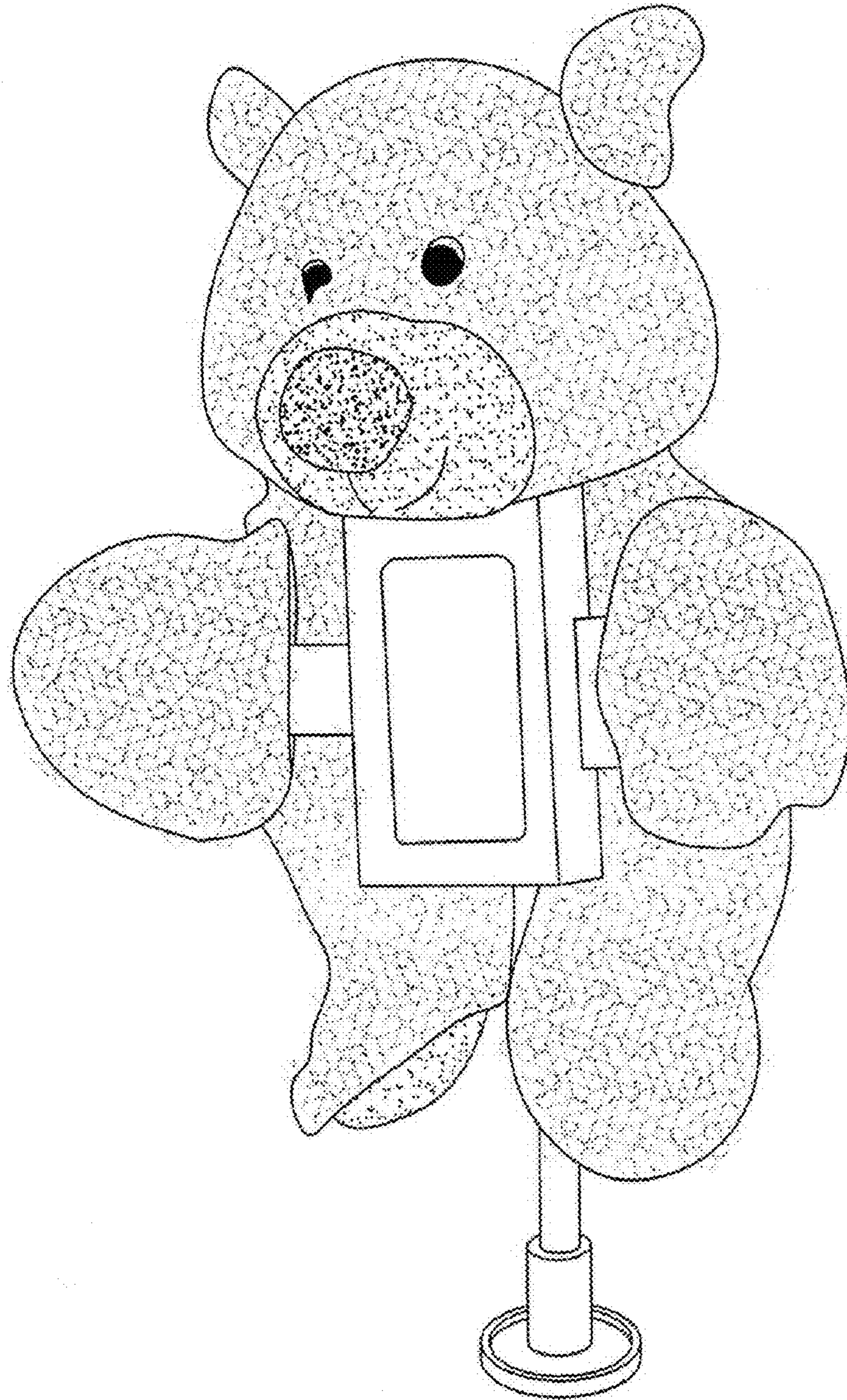

FIG. 1



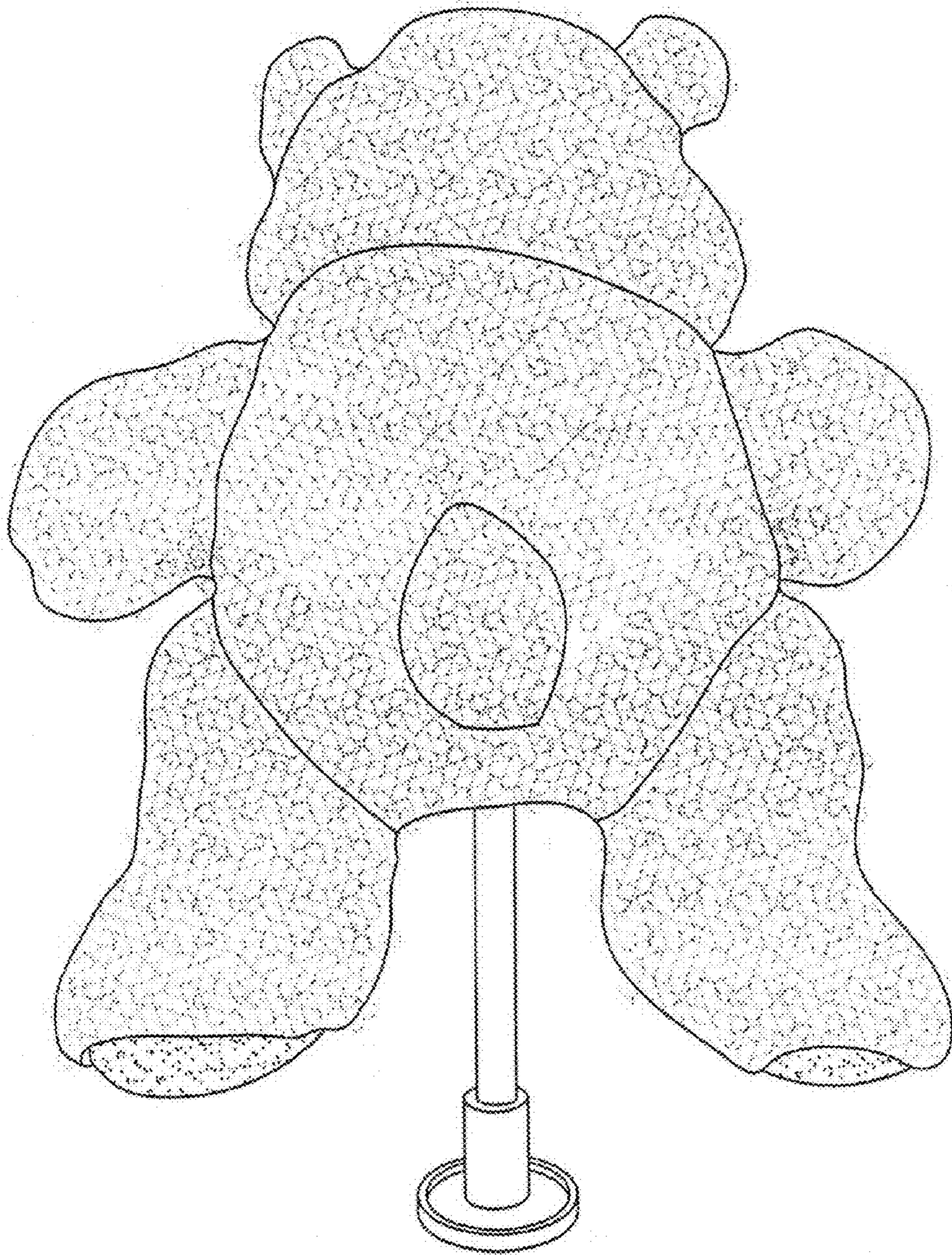

FIG. 2



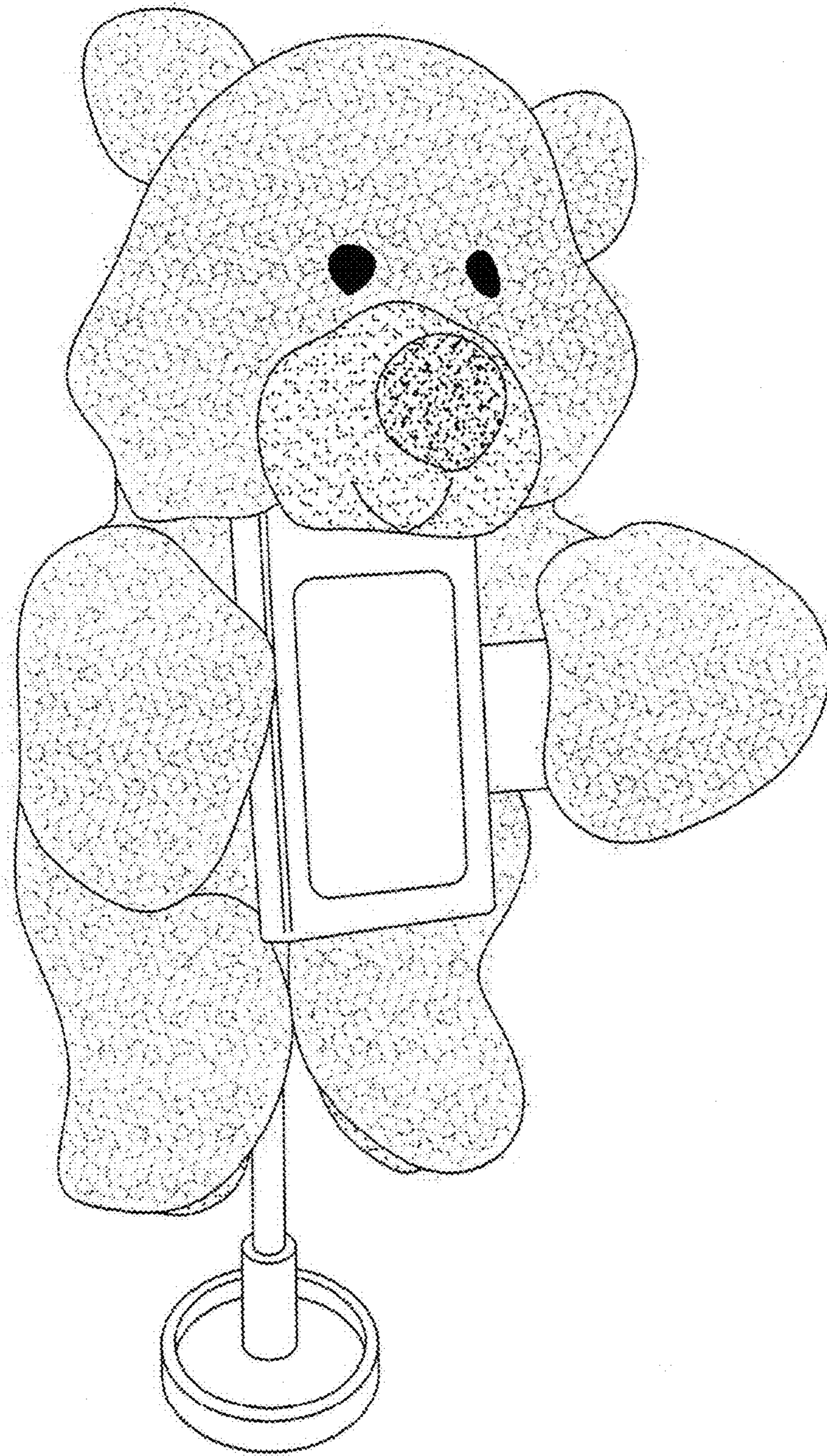

FIG. 3

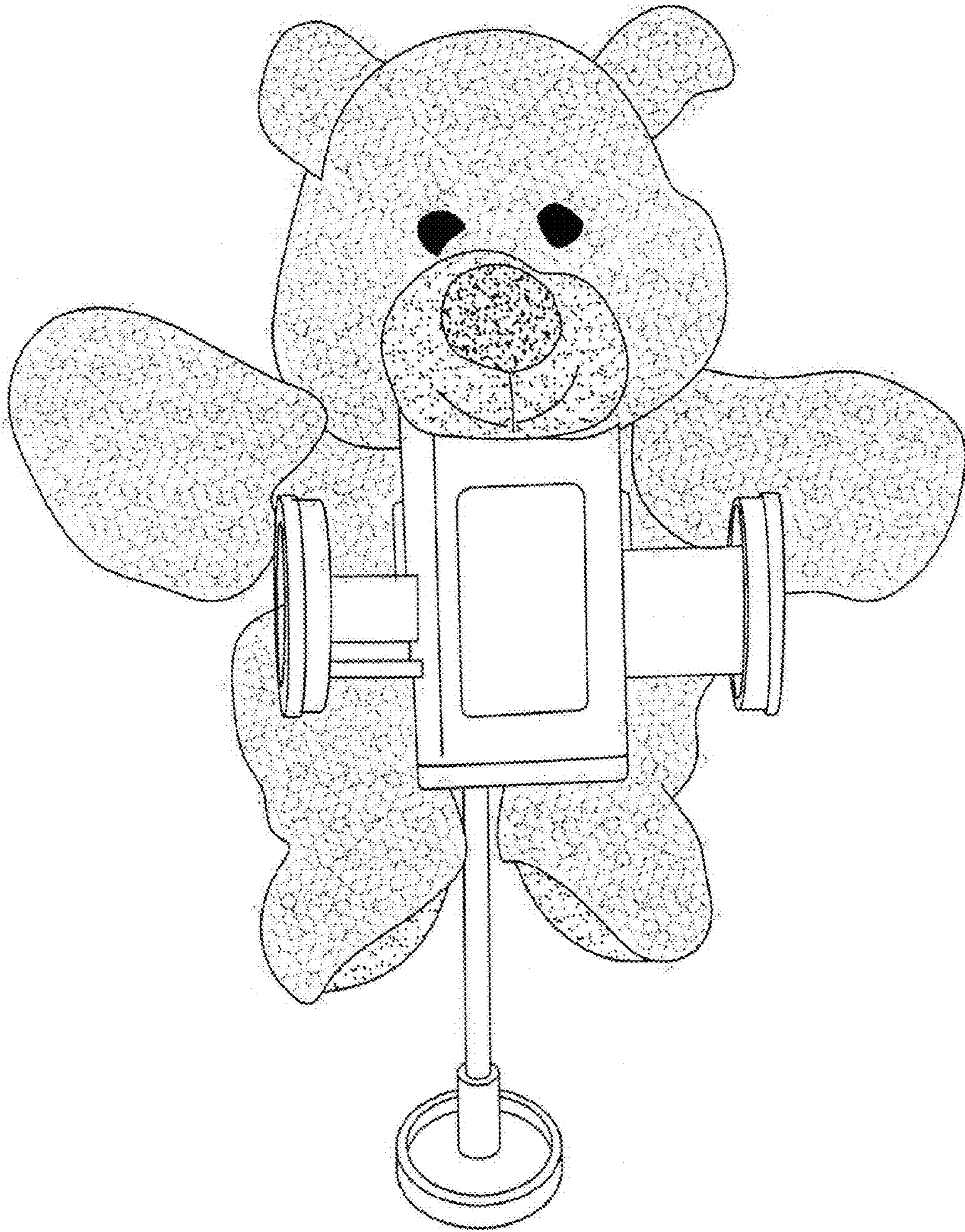

FIG. 4



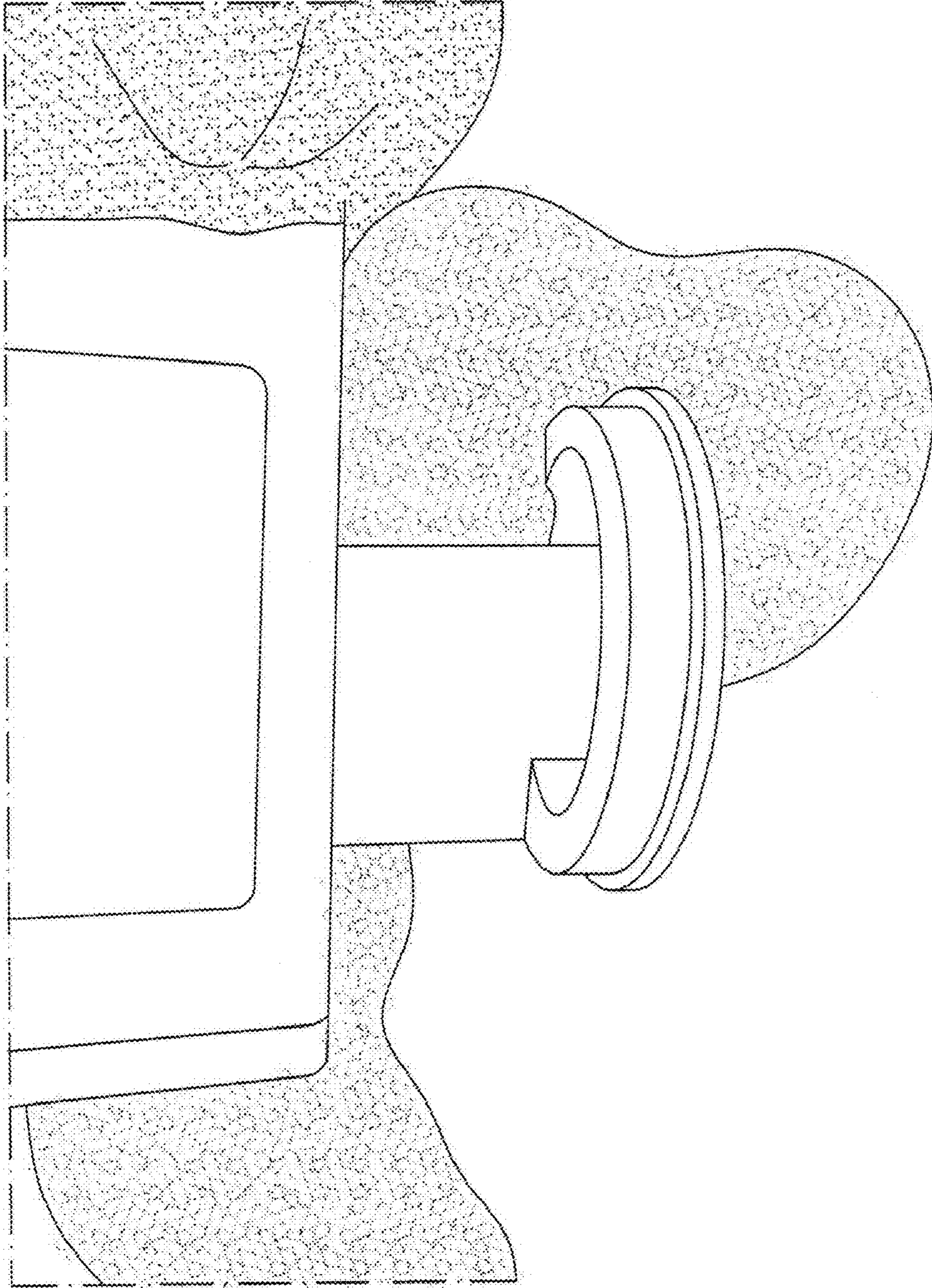

FIG. 5

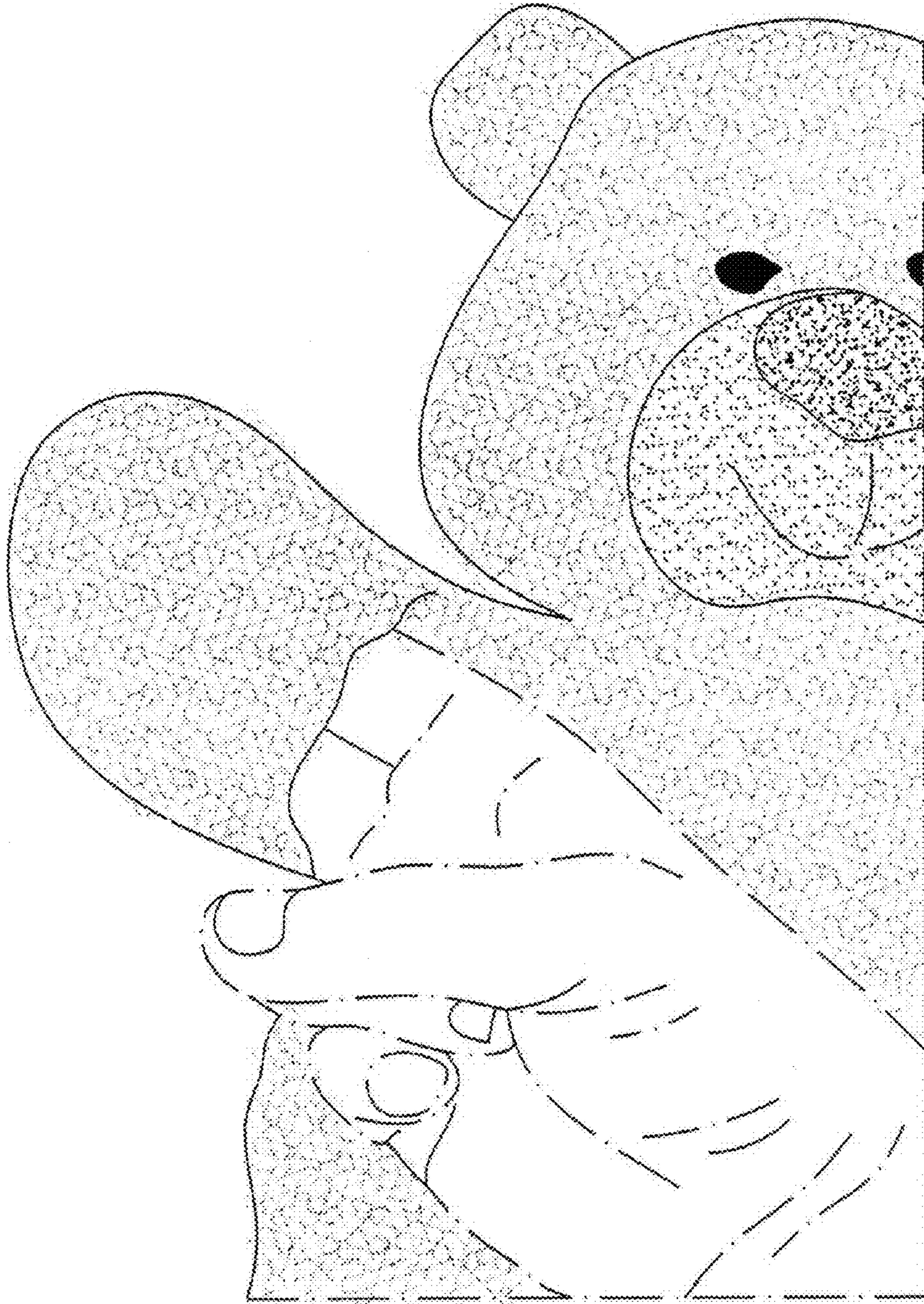

FIG. 6