



US00D666124S

(12) **United States Design Patent**
Dunn

(10) **Patent No.:** **US D666,124 S**

(45) **Date of Patent:** **** Aug. 28, 2012**

(54) **STAR DISPLAY HOLDER FOR A CORD**

2,616,196 A * 11/1952 Sandahl, Jr. et al. 40/606.03
2,786,983 A 3/1957 Hill
3,203,700 A 8/1965 Antoniouus

(76) Inventor: **Scott Eben Dunn**, Atlanta, GA (US)

(Continued)

(**) Term: **14 Years**

FOREIGN PATENT DOCUMENTS

(21) Appl. No.: **29/411,297**

WO WO-2010132567 A1 11/2010

(22) Filed: **Jan. 19, 2012**

OTHER PUBLICATIONS

(51) **LOC (9) Cl.** **11-99**

Specification, Claims, and Drawings entered by the U.S. Patent and Trademark Office on Feb. 4, 2011 for U.S. Appl. No. 61/439,606, filed Feb. 4, 2011 (First Named Inventor—Dunn) (21 pages).

(52) **U.S. Cl.** **D11/184**

(58) **Field of Classification Search** D11/184;

D8/105, 107, 333, 349, 354, 356, 358, 367,
D8/373, 382, 383, 394–396; D23/261; D26/38;
24/197, 561; 174/153 G; 242/400.1, 405.1,
242/405.2, 600, 916; 248/65, 74.1–74.4,
248/214, 215, 229.26, 201, 302, 204, 316.7,
248/316.8; 439/501; D34/38; 108/57.52

See application file for complete search history.

(Continued)

Primary Examiner — T. Chase Nelson
Assistant Examiner — Michelle E Wilson
(74) *Attorney, Agent, or Firm* — Ballard Spahr LLP

(57) **CLAIM**

The ornamental design for a star display holder for a cord, as shown and described.

DESCRIPTION

(56) **References Cited**

U.S. PATENT DOCUMENTS

168,063 A	9/1875	Taylor
807,747 A	12/1905	Kling
1,195,276 A	8/1916	Seaman
1,337,722 A	4/1920	Porter
1,388,219 A	8/1921	Thompson
D67,289 S	5/1925	Ladewich
1,593,078 A	7/1926	Jacoss
1,832,318 A	11/1931	Myers
2,083,431 A	6/1937	Cole
D133,983 S	10/1942	Anderson
D137,768 S	4/1944	Shirley
2,355,154 A	8/1944	Goudreau
D156,622 S	12/1949	Harmon
2,601,088 A	6/1952	Burgess
D167,185 S	7/1952	Wendt
2,611,615 A	9/1952	Watson

FIG. 1 is a perspective view of a star display holder for a cord of the present invention;
FIG. 2 is a front elevational view of the star display holder for a cord of FIG. 1;
FIG. 3 is a rear elevational view of the star display holder for a cord of FIG. 1;
FIG. 4 is a left side elevational view of the star display holder for a cord of FIG. 1;
FIG. 5 is a right side elevational view of the star display holder for a cord of FIG. 1;
FIG. 6 is a top elevational view of the star display holder for a cord of FIG. 1; and,
FIG. 7 is a bottom elevational view of the star display holder for a cord of FIG. 1.

1 Claim, 5 Drawing Sheets

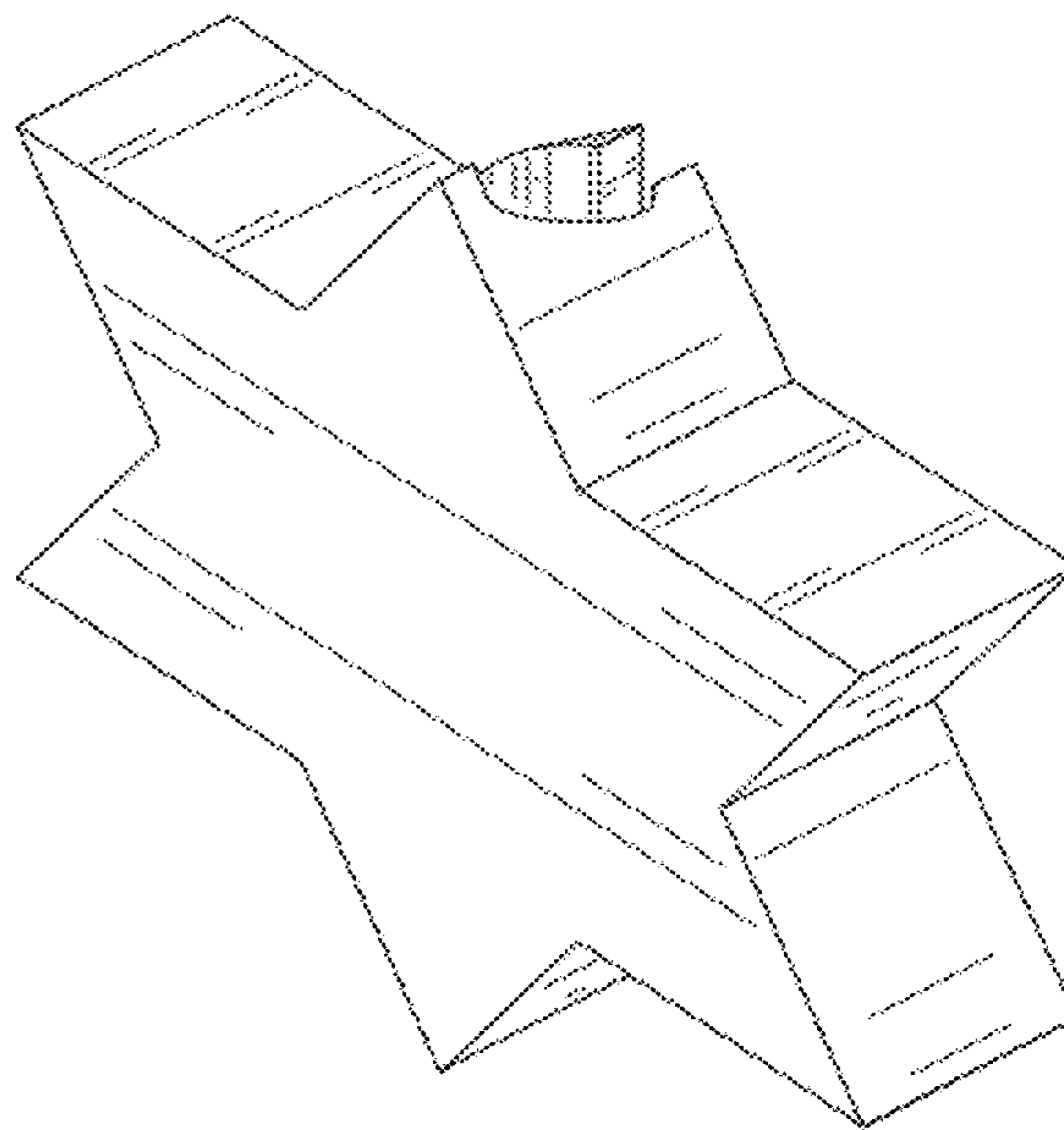

US D666,124 S

Page 2

U.S. PATENT DOCUMENTS			
3,228,640	A *	1/1966	Wolsh 248/72
3,322,381	A *	5/1967	Bubb 248/121
3,519,731	A	7/1970	Grunbaum
3,576,304	A	4/1971	Gillemot et al.
3,696,920	A *	10/1972	Lahay 206/370
3,766,854	A	10/1973	Scarlet
3,772,809	A	11/1973	Schneller
3,788,269	A	1/1974	Scarlet
D235,023	S *	4/1975	Swayze D14/229
4,004,362	A	1/1977	Barbieri
4,011,673	A	3/1977	Levine
4,103,949	A	8/1978	Bouloy
4,131,226	A	12/1978	Breiter et al.
4,177,750	A	12/1979	Scarlet
4,198,202	A	4/1980	Kleber
D256,398	S	8/1980	Mitchell
4,261,121	A	4/1981	Coon
4,294,895	A	10/1981	Atkins
D266,054	S	9/1982	Goodman
4,398,444	A	8/1983	Walker
D270,525	S *	9/1983	Bayusik D11/125
D275,174	S	8/1984	Rolli
4,464,834	A	8/1984	Simms
D280,393	S *	9/1985	Lee D11/70
D280,394	S *	9/1985	Lee D11/70
4,539,767	A	9/1985	Jaffe
D285,044	S	8/1986	Mockett
D289,138	S	4/1987	Nead
4,656,767	A	4/1987	Tarrant
D289,732	S	5/1987	Jason
D293,766	S	1/1988	Lamb
4,738,817	A	4/1988	Wittwer et al.
4,821,988	A *	4/1989	Jimenez 248/227.3
4,856,214	A	8/1989	Machen
D305,254	S	12/1989	Bateman et al.
D308,011	S	5/1990	Norris
D314,529	S *	2/1991	Willard D11/120
D317,171	S	5/1991	Saks
D321,913	S	11/1991	Wolff
D325,400	S	4/1992	Wolff
5,122,068	A	6/1992	Koss
5,161,799	A	11/1992	Nandra
5,203,129	A *	4/1993	Johnson 52/202
5,207,174	A	5/1993	Fabbrini
5,209,992	A	5/1993	Feres
D336,131	S *	6/1993	Nordstrom et al. D24/128
D340,038	S	10/1993	Venne et al.
D356,350	S	3/1995	Berggreen
D358,615	S	5/1995	Cline
D364,201	S	11/1995	Jensen
D365,781	S	1/1996	Osborn
5,479,735	A *	1/1996	Martin, Jr. 40/593
D369,042	S	4/1996	Kinart
D369,758	S *	5/1996	Remidio D11/90
5,536,096	A	7/1996	Nowak
5,537,042	A	7/1996	Beutler et al.
5,584,122	A	12/1996	Kato et al.
5,657,198	A	8/1997	Flener
5,669,191	A *	9/1997	Weaver 52/202
D388,833	S	1/1998	Wilson
5,712,767	A	1/1998	Koizumi
D390,066	S *	2/1998	Watkins et al. D7/633
D393,345	S *	4/1998	Clegg et al. D2/869
5,740,622	A	4/1998	Martin
D396,146	S *	7/1998	Blue D4/113
D401,883	S	12/1998	Madhvani
5,845,883	A *	12/1998	Meyer 248/73
5,869,784	A	2/1999	Shinchi
D407,453	S	3/1999	Rashman
5,887,368	A	3/1999	Rupp
D412,136	S	7/1999	Namdar et al.
5,922,993	A	7/1999	Ide et al.
5,925,202	A	7/1999	Ide et al.
5,929,384	A	7/1999	Ide et al.
5,933,995	A	8/1999	Gorbach
5,934,509	A	8/1999	Niss
D413,544	S *	9/1999	Steinberg D11/91
5,971,436	A	10/1999	Cox
5,979,028	A	11/1999	Hicks et al.
D421,773	S	3/2000	Yashar
6,087,589	A	7/2000	Ide
6,120,565	A	9/2000	Dix et al.
D436,518	S	1/2001	Matsubara
D438,624	S	3/2001	Reina
D438,788	S *	3/2001	Rigel D9/669
6,226,865	B1	5/2001	Tanikawa et al.
D446,676	S	8/2001	Mayes
D446,903	S *	8/2001	Pavan D1/106
6,269,573	B1 *	8/2001	Najmi 40/666
D448,276	S	9/2001	Kelleghan
6,301,756	B1	10/2001	Howard
D449,981	S *	11/2001	Davis D9/669
D452,135	S *	12/2001	Wyatt et al. D8/354
6,332,247	B1	12/2001	Hsieh
D454,244	S	3/2002	Scheff
D454,971	S	3/2002	Crosby
D455,145	S	4/2002	Williams
D456,016	S	4/2002	Denson
D456,389	S	4/2002	Denson
D456,692	S *	5/2002	Epstein D8/356
D457,157	S	5/2002	Best
6,381,840	B2	5/2002	Ide
6,392,147	B1	5/2002	Hier et al.
D459,194	S	6/2002	Johansson et al.
6,409,131	B1 *	6/2002	Bentley et al. 248/219.4
D460,350	S	7/2002	Davis
6,430,782	B1	8/2002	Torres et al.
D465,993	S	11/2002	Kelleghan
6,490,789	B1	12/2002	Ide
6,497,063	B1	12/2002	Stephens
D477,772	S *	7/2003	Nezu D8/383
6,598,558	B2	7/2003	Griffin
6,634,528	B2	10/2003	Hurtgam
D481,649	S	11/2003	Samuels
D482,391	S *	11/2003	Hui D19/36
6,651,362	B2	11/2003	Caveney
6,657,126	B2	12/2003	Ide et al.
6,662,445	B2	12/2003	Tanikawa et al.
D485,783	S	1/2004	Youngman
D486,926	S *	2/2004	Yuen D26/26
D490,692	S	6/2004	Williams
D491,836	S	6/2004	Haimoff
D492,800	S *	7/2004	Yuen D26/26
D494,087	S	8/2004	Lax
D494,090	S	8/2004	Lax
D494,091	S	8/2004	Lax
D494,092	S	8/2004	Lax
D494,093	S	8/2004	Lax
6,844,499	B2	1/2005	Ide et al.
D502,122	S	2/2005	Lax
6,858,804	B2	2/2005	Murakami et al.
D505,091	S	5/2005	Youngman
D505,356	S *	5/2005	Ho D11/90
D507,508	S	7/2005	Brownell
6,940,020	B2	9/2005	Ide et al.
D511,709	S *	11/2005	Mehta D11/90
D511,987	S	11/2005	Swarovski
D511,989	S	11/2005	De Castro et al.
D512,934	S *	12/2005	Voorn D11/90
D514,978	S	2/2006	Lakhi
D520,676	S	5/2006	Chen
D521,409	S	5/2006	De Castro et al.
7,073,282	B2	7/2006	Savagian et al.
7,111,812	B2 *	9/2006	Shannon et al. 248/230.7
D529,557	S	10/2006	Greenwald
D534,594	S	1/2007	Revere
D535,907	S	1/2007	Sevdermish
D538,351	S	3/2007	Strong et al.
D542,123	S	5/2007	Symons
D548,057	S	8/2007	Kelleghan
D563,157	S	3/2008	Bouveret et al.
D563,616	S	3/2008	Lynde et al.
D563,828	S	3/2008	Meijer
D568,723	S	5/2008	Morgan
D572,126	S	7/2008	Tomaka
D572,165	S	7/2008	Lichtenstein
D578,163	S	10/2008	Chou

D578,275 S	10/2008	Shantz et al.	
D585,196 S	1/2009	Bundrick	
D587,162 S	2/2009	Baker	
D587,163 S	2/2009	Baker	
D587,164 S	2/2009	Baker	
D587,623 S	3/2009	Baker	
D587,624 S	3/2009	Baker	
D589,328 S	3/2009	Edge	
7,509,765 B2	3/2009	Flores	
D590,676 S	4/2009	Pickard	
D590,885 S	4/2009	Love	
D592,540 S	5/2009	Rydlawicz	
D599,246 S	9/2009	Rudes	
D609,951 S	2/2010	Walker	
D610,482 S	2/2010	Shaw	
7,687,999 B2	3/2010	Essick et al.	
D618,985 S *	7/2010	Sjoqvist	D8/356
D626,880 S	11/2010	Castaline et al.	
D629,286 S	12/2010	Laskowski	
D629,671 S *	12/2010	Ohuri et al.	D8/356
D635,485 S *	4/2011	Schanzer	D11/81
D639,408 S	6/2011	Newman	
D639,700 S	6/2011	Adams et al.	
D644,150 S	8/2011	Edick	
D644,501 S	9/2011	Chen	
D645,345 S	9/2011	Liebowitz et al.	
D646,730 S	10/2011	Burch	
D652,460 S	1/2012	Kulzer	
D652,766 S	1/2012	Dunn	
D652,767 S	1/2012	Dunn	
D653,163 S	1/2012	Dunn	
D653,164 S	1/2012	Dunn	
D653,165 S	1/2012	Dunn	
D653,166 S	1/2012	Dunn	
D653,167 S	1/2012	Dunn	
D653,168 S	1/2012	Dunn	
D655,887 S	3/2012	Zbuchalski	
D656,067 S	3/2012	Dunn	
2008/0285785 A1	11/2008	Zieg et al.	
2012/0031981 A1 *	2/2012	Westlake et al.	235/492

OTHER PUBLICATIONS

Specification, Claims, and Drawings entered by the U.S. Patent and Trademark Office on Feb. 6, 2012 for U.S. Appl. No. 13/367,352, filed Feb. 6, 2012 (First Named Inventor—Dunn) (28 pages).

Specification, Claims, and Drawings entered by the U.S. Patent and Trademark Office on Jun. 18, 2011 for U.S. Appl. No. 29/394,588, filed Jun. 18, 2011 (First Named Inventor—Dunn) (34 pages).

Requirement for Restriction/Election entered by the U.S. Patent and Trademark Office on Sep. 21, 2011 for U.S. Appl. No. 29/394,588, filed Jun. 18, 2011 (First Named Inventor—Dunn) (5 pages).

Response to Election/Restriction Filed entered by the U.S. Patent and Trademark Office on Nov. 21, 2011 for U.S. Appl. No. 29/394,588, filed Jun. 18, 2011 (First Named Inventor—Dunn) (2 pages).

Notice of Allowance and Fees Due entered by the U.S. Patent and Trademark Office on Jan. 6, 2012 for U.S. Appl. No. 29/394,588, filed Jun. 18, 2011 (First Named Inventor—Dunn) (8 pages).

Specification, Claims, and Drawings entered by the U.S. Patent and Trademark Office on Jun. 18, 2011 for U.S. Appl. No. 29/394,589, filed Jun. 18, 2011 (First Named Inventor—Dunn) (12 pages).

Notice of Allowance and Fees Due entered by the U.S. Patent and Trademark Office on Sep. 20, 2011 for U.S. Appl. No. 29/394,589, filed Jun. 18, 2011 (First Named Inventor—Dunn) (7 pages).

Supplemental Notice of Allowability entered by the U.S. Patent and Trademark Office on Nov. 14, 2011 for U.S. Appl. No. 29/394,589, filed Jun. 18, 2011 (First Named Inventor—Dunn) (4 pages).

Issue Notification entered by the U.S. Patent and Trademark Office on Jan. 11, 2012 for U.S. Appl. No. 29/394,589, filed Jun. 18, 2011 (First Named Inventor—Dunn) (1 page).

Specification, Claims, and Drawings entered by the U.S. Patent and Trademark Office on Jun. 18, 2011 for U.S. Appl. No. 29/394,590, filed Jun. 18, 2011 (First Named Inventor—Dunn) (14 pages).

Notice of Allowance and Fees Due entered by the U.S. Patent and Trademark Office on Sep. 23, 2011 for U.S. Appl. No. 29/394,590, filed Jun. 18, 2011 (First Named Inventor—Dunn) (7 pages).

Supplemental Notice of Allowability entered by the U.S. Patent and Trademark Office on Oct. 25, 2011 for U.S. Appl. No. 29/394,590, filed Jun. 18, 2011 (First Named Inventor—Dunn) (2 pages).

Issue Notification entered by the U.S. Patent and Trademark Office on Jan. 4, 2012 for U.S. Appl. No. 29/394,590, filed Jun. 18, 2011 (First Named Inventor—Dunn) (1 page).

Specification, Claims, and Drawings entered by the U.S. Patent and Trademark Office on Jun. 18, 2011 for U.S. Appl. No. 29/394,591, filed Jun. 18, 2011 (First Named Inventor—Dunn) (10 pages).

Notice of Allowance and Fees Due entered by the U.S. Patent and Trademark Office on Sep. 19, 2011 for U.S. Appl. No. 29/394,591, filed Jun. 18, 2011 (First Named Inventor—Dunn) (7 pages).

Supplemental Notice of Allowability entered by the U.S. Patent and Trademark Office on Oct. 12, 2011 for U.S. Appl. No. 29/394,591, filed Jun. 18, 2011 (First Named Inventor—Dunn) (2 pages).

Issue Notification entered by the U.S. Patent and Trademark Office on Jan. 11, 2012 for U.S. Appl. No. 29/394,591, filed Jun. 18, 2011 (First Named Inventor—Dunn) (1 page).

Specification, Claims, and Drawings entered by the U.S. Patent and Trademark Office on Jun. 18, 2011 for U.S. Appl. No. 29/394,592, filed Jun. 18, 2011 (First Named Inventor—Dunn) (18 pages).

Requirement for Restriction/Election entered by the U.S. Patent and Trademark Office on Sep. 22, 2011 for U.S. Appl. No. 29/394,592, filed Jun. 18, 2011 (First Named Inventor—Dunn) (5 pages).

Response to Restriction Requirement entered by the U.S. Patent and Trademark Office on Oct. 27, 2011 for U.S. Appl. No. 29/394,592, filed Jun. 18, 2011 (First Named Inventor—Dunn) (2 pages).

Notice of Allowance and Fees Due entered by the U.S. Patent and Trademark Office on Dec. 20, 2011 for U.S. Appl. No. 29/394,592, filed Jun. 18, 2011 (First Named Inventor—Dunn) (9 pages).

Specification, Claims, and Drawings entered by the U.S. Patent and Trademark Office on Jun. 18, 2011 for U.S. Appl. No. 29/394,593, filed Jun. 18, 2011 (First Named Inventor—Dunn) (12 pages).

Notice of Allowance and Fees Due entered by the U.S. Patent and Trademark Office on Sep. 20, 2011 for U.S. Appl. No. 29/394,593, filed Jun. 18, 2011 (First Named Inventor—Dunn) (7 pages).

Supplemental Notice of Allowability entered by the U.S. Patent and Trademark Office on Oct. 12, 2011 for U.S. Appl. No. 29/394,593, filed Jun. 18, 2011 (First Named Inventor—Dunn) (2 pages).

Issue Notification entered by the U.S. Patent and Trademark Office on Jan. 11, 2012 for U.S. Appl. No. 29/394,593, filed Jun. 18, 2011 (First Named Inventor—Dunn) (1 page).

Specification, Claims, and Drawings entered by the U.S. Patent and Trademark Office on Jun. 18, 2011 for U.S. Appl. No. 29/394,594, filed Jun. 18, 2011 (First Named Inventor—Dunn) (7 pages).

Notice of Allowance and Fees Due entered by the U.S. Patent and Trademark Office on Sep. 23, 2011 for U.S. Appl. No. 29/394,594, filed Jun. 18, 2011 (First Named Inventor—Dunn) (7 pages).

Supplemental Notice of Allowability entered by the U.S. Patent and Trademark Office on Nov. 29, 2011 for U.S. Appl. No. 29/394,594, filed Jun. 18, 2011 (First Named Inventor—Dunn) (2 pages).

Issue Notification entered by the U.S. Patent and Trademark Office on Jan. 11, 2012 for U.S. Appl. No. 29/394,594, filed Jun. 18, 2011 (First Named Inventor—Dunn) (1 page).

Specification, Claims, and Drawings entered by the U.S. Patent and Trademark Office on Jun. 18, 2011 for U.S. Appl. No. 29/394,595, filed Jun. 18, 2011 (First Named Inventor—Dunn) (12 pages).

Notice of Allowance and Fees Due entered by the U.S. Patent and Trademark Office on Sep. 23, 2011 for U.S. Appl. No. 29/394,595, filed Jun. 18, 2011 (First Named Inventor—Dunn) (7 pages).

Supplemental Notice of Allowability entered by the U.S. Patent and Trademark Office on Oct. 26, 2011 for U.S. Appl. No. 29/394,595, filed Jun. 18, 2011 (First Named Inventor—Dunn) (2 pages).

Issue Notification entered by the U.S. Patent and Trademark Office on Jan. 11, 2012 for U.S. Appl. No. 29/394,595, filed Jun. 18, 2011 (First Named Inventor—Dunn) (1 page).

Specification, Claims, and Drawings entered by the U.S. Patent and Trademark Office on Jun. 18, 2011 for U.S. Appl. No. 29/394,596, filed Jun. 18, 2011 (First Named Inventor—Dunn) (23 pages).

Requirement for Restriction/Election entered by the U.S. Patent and Trademark Office on Sep. 29, 2011 for U.S. Appl. No. 29/394,596, filed Jun. 18, 2011 (First Named Inventor—Dunn) (5 pages).

Response to Restriction Requirement entered by the U.S. Patent and Trademark Office on Nov. 4, 2011 for U.S. Appl. No. 29/394,596, filed Jun. 18, 2011 (First Named Inventor—Dunn) (2 pages).

Notice of Allowance and Fees Due entered by the U.S. Patent and Trademark Office on Dec. 13, 2011 for U.S. Appl. No. 29/394,596, filed Jun. 18, 2011 (First Named Inventor—Dunn) (9 pages).

Specification, Claims, and Drawings entered by the U.S. Patent and Trademark Office on Jun. 18, 2011 for U.S. Appl. No. 29/394,597, filed Jun. 18, 2011 (First Named Inventor—Dunn) (29 pages).

Requirement for Restriction/Election entered by the U.S. Patent and Trademark Office on Sep. 29, 2011 for U.S. Appl. No. 29/394,597, filed Jun. 18, 2011 (First Named Inventor—Dunn) (5 pages).

Response to Restriction Requirement entered by the U.S. Patent and Trademark Office on Nov. 29, 2011 for U.S. Appl. No. 29/394,597, filed Jun. 18, 2011 (First Named Inventor—Dunn) (2 pages).

Notice of Allowance and Fees Due entered by the U.S. Patent and Trademark Office on Jan. 5, 2012 for U.S. Appl. No. 29/394,597, filed Jun. 18, 2011 (First Named Inventor—Dunn) (8 pages).

Specification, Claims, and Drawings entered by the U.S. Patent and Trademark Office on Jun. 18, 2011 for U.S. Appl. No. 29/394,598, filed Jun. 18, 2011 (First Named Inventor—Dunn) (7 pages).

Notice of Allowance and Fees Due entered by the U.S. Patent and Trademark Office on Sep. 19, 2011 for U.S. Appl. No. 29/394,598, filed Jun. 18, 2011 (First Named Inventor—Dunn) (7 pages).

Supplemental Notice of Allowability entered by the U.S. Patent and Trademark Office on Oct. 25, 2011 for U.S. Appl. No. 29/394,598, filed Jun. 18, 2011 (First Named Inventor—Dunn) (2 pages).

Issue Notification entered by the U.S. Patent and Trademark Office on Jan. 4, 2012 for U.S. Appl. No. 29/394,598, filed Jun. 18, 2011 (First Named Inventor—Dunn) (1 page).

Specification, Claims, and Drawings entered by the U.S. Patent and Trademark Office on Jun. 18, 2011 for U.S. Appl. No. 29/394,599, filed Jun. 18, 2011 (First Named Inventor—Dunn) (8 pages).

Notice of Allowance and Fees Due entered by the U.S. Patent and Trademark Office on Sep. 23, 2011 for U.S. Appl. No. 29/394,599, filed Jun. 18, 2011 (First Named Inventor—Dunn) (7 pages).

Supplemental Notice of Allowability entered by the U.S. Patent and Trademark Office on Oct. 26, 2011 for U.S. Appl. No. 29/394,599, filed Jun. 18, 2011 (First Named Inventor—Dunn) (2 pages).

Issue Notification entered by the U.S. Patent and Trademark Office on Jan. 11, 2012 for U.S. Appl. No. 29/394,599, filed Jun. 18, 2011 (First Named Inventor—Dunn) (1 page).

Specification, Claims, and Drawings entered by the U.S. Patent and Trademark Office on Jun. 18, 2011 for U.S. Appl. No. 29/394,600, filed Jun. 18, 2011 (First Named Inventor—Dunn) (12 pages).

Requirement for Restriction/Election entered by the U.S. Patent and Trademark Office on Sep. 29, 2011 for U.S. Appl. No. 29/394,600, filed Jun. 18, 2011 (First Named Inventor—Dunn) (5 pages).

Response to Restriction Requirement entered by the U.S. Patent and Trademark Office on Nov. 17, 2011 for U.S. Appl. No. 29/394,600, filed Jun. 18, 2011 (First Named Inventor—Dunn) (2 pages).

Notice of Allowance and Fees Due entered by the U.S. Patent and Trademark Office on Dec. 12, 2011 for U.S. Appl. No. 29/394,600, filed Jun. 18, 2011 (First Named Inventor—Dunn) (9 pages).

Amendment and Response to Notice of Allowability entered by the U.S. Patent and Trademark Office on Feb. 2, 2012 for U.S. Appl. No. 29/394,600, filed Jun. 18, 2011 (First Named Inventor—Dunn) (9 pages).

Issue Notification entered by the U.S. Patent and Trademark Office on Feb. 29, 2012 for U.S. Appl. No. 29/394,600, filed Jun. 18, 2011 (First Named Inventor—Dunn) (1 page).

Specification, Claims, and Drawings entered by the U.S. Patent and Trademark Office on Jan. 19, 2012 for U.S. Appl. No. 29/411,283, filed Jan. 19, 2012 (First Named Inventor—Dunn) (7 pages).

Specification, Claims, and Drawings entered by the U.S. Patent and Trademark Office on Jan. 19, 2012 for U.S. Appl. No. 29/411,284, filed Jan. 19, 2012 (First Named Inventor—Dunn) (7 pages).

Specification, Claims, and Drawings entered by the U.S. Patent and Trademark Office on Jan. 19, 2012 for U.S. Appl. No. 29/411,285, filed Jan. 19, 2012 (First Named Inventor—Dunn) (7 pages).

Notice of Allowance entered by the U.S. Patent and Trademark Office on Apr. 9, 2012 for U.S. Appl. No. 29/411,285, filed Jan. 19, 2012 (First Named Inventor—Dunn) (7 pages).

Specification, Claims, and Drawings entered by the U.S. Patent and Trademark Office on Jan. 19, 2012 for U.S. Appl. No. 29/411,286, filed Jan. 19, 2012 (First Named Inventor—Dunn) (7 pages).

Notice of Allowance and Fees Due entered by the U.S. Patent and Trademark Office on Mar. 2, 2012 for U.S. Appl. No. 29/411,286, filed Jan. 19, 2012 (First Named Inventor—Dunn) (7 pages).

Specification, Claims, and Drawings entered by the U.S. Patent and Trademark Office on Jan. 19, 2012 for U.S. Appl. No. 29/411,288, filed Jan. 19, 2012 (First Named Inventor—Dunn) (7 pages).

Specification, Claims, and Drawings entered by the U.S. Patent and Trademark Office on Jan. 19, 2012 for U.S. Appl. No. 29/411,291, filed Jan. 19, 2012 (First Named Inventor—Dunn) (7 pages).

Specification, Claims, and Drawings entered by the U.S. Patent and Trademark Office on Jan. 19, 2012 for U.S. Appl. No. 29/411,293, filed Jan. 19, 2012 (First Named Inventor—Dunn) (7 pages).

Specification, Claims, and Drawings entered by the U.S. Patent and Trademark Office on Jan. 19, 2012 for U.S. Appl. No. 29/411,295, filed Jan. 19, 2012 (First Named Inventor—Dunn) (7 pages).

Notice of Allowance entered by the U.S. Patent and Trademark Office on Apr. 4, 2012 for U.S. Appl. No. 29/411,295, filed Jan. 19, 2012 (First Named Inventor—Dunn) (7 pages).

Specification, Claims, and Drawings entered by the U.S. Patent and Trademark Office on Jan. 19, 2012 for U.S. Appl. No. 29/411,296, filed Jan. 19, 2012 (First Named Inventor—Dunn) (7 pages).

Specification, Claims, and Drawings entered by the U.S. Patent and Trademark Office on Jan. 19, 2012 for U.S. Appl. No. 29/411,298, filed Jan. 19, 2012 (First Named Inventor—Dunn) (7 pages).

Specification, Claims, and Drawings entered by the U.S. Patent and Trademark Office on Jan. 19, 2012 for U.S. Appl. No. 29/411,300, filed Jan. 19, 2012 (First Named Inventor—Dunn) (8 pages).

Specification, Claims, and Drawings entered by the U.S. Patent and Trademark Office on Jan. 19, 2012 for U.S. Appl. No. 29/411,302, filed Jan. 19, 2012 (First Named Inventor—Dunn) (8 pages).

Specification, Claims, and Drawings entered by the U.S. Patent and Trademark Office on Jan. 19, 2012 for U.S. Appl. No. 29/411,309, filed Jan. 19, 2012 (First Named Inventor—Dunn) (8 pages).

Specification, Claims, and Drawings entered by the U.S. Patent and Trademark Office on Jan. 19, 2012 for U.S. Appl. No. 29/411,311, filed Jan. 19, 2012 (First Named Inventor—Dunn) (8 pages).

Specification, Claims, and Drawings entered by the U.S. Patent and Trademark Office on Jan. 19, 2012 for U.S. Appl. No. 29/411,313, filed Jan. 19, 2012 (First Named Inventor—Dunn) (8 pages).

Specification, Claims, and Drawings entered by the U.S. Patent and Trademark Office on Jan. 19, 2012 for U.S. Appl. No. 29/411,315, filed Jan. 19, 2012 (First Named Inventor—Dunn) (8 pages).

Specification, Claims, and Drawings entered by the U.S. Patent and Trademark Office on Jan. 19, 2012 for U.S. Appl. No. 29/411,316, filed Jan. 19, 2012 (First Named Inventor—Dunn) (8 pages).

Stick'nGo, <http://stickngo.com.au>, Stick'nGo Cables Label, Accessed Nov. 26, 2010.

Fiber Network Tools, <http://www.fibernetnetworktools.com/catalog2.php>, FNT Cables and Assemblies, Accessed Nov. 26, 2010.

NELCO Products Incorporated, <http://www.nelcoproducts.com>, NELCO Blank Flag Tie Markets, Accessed Nov. 26, 2010.

Sunlec International, <http://www.sunlec.com.au>, Sunlec International Cable Sleeves, Accessed Nov. 26, 2010.

The Cable Label Co., <http://www.thecablelabelco.co.uk/buy.php>, Buy Cable Bug Labels in Bags, Accessed Nov. 26, 2010.

The Storage Store, <http://www.thestoragelabelco.com>, Computer Cable Flags, Accessed Nov. 26, 2010.

Non-final Office Action entered by the U.S. Patent and Trademark Office on Mar. 6, 2012 for U.S. Appl. No. 29/411,283, filed Jan. 19, 2012 (First Named Inventor—Dunn) (5 pages).

Non-final Office Action entered by the U.S. Patent and Trademark Office on Mar. 26, 2012 for U.S. Appl. No. 29/411,284, filed Jan. 19, 2012 (First Named Inventor—Dunn) (5 pages).

Notice of Allowance and Fees Due entered by the U.S. Patent and Trademark Office on Mar. 6, 2012 for U.S. Appl. No. 29/411,288, filed Jan. 19, 2012 (First Named Inventor—Dunn) (7 pages).

Notice of Allowance entered by the U.S. Patent and Trademark Office on Apr. 4, 2012 for U.S. Appl. No. 29/411,291, filed Jan. 19, 2012 (First Named Inventor—Dunn) (7 pages).

Notice of Allowance entered by the U.S. Patent and Trademark Office on Apr. 4, 2012 for U.S. Appl. No. 29/411,293, filed Jan. 19, 2012 (First Named Inventor—Dunn) (7 pages).

Notice of Allowance entered by the U.S. Patent and Trademark Office on Apr. 2, 2012 for U.S. Appl. No. 29/411,298, filed Jan. 19, 2012 (First Named Inventor—Dunn) (7 pages).

Notice of Allowance entered by the U.S. Patent and Trademark Office on Apr. 2, 2012 for U.S. Appl. No. 29/411,300, filed Jan. 19, 2012 (First Named Inventor—Dunn) (7 pages).

Office Action entered by the U.S. Patent and Trademark Office on Mar. 30, 2012 for U.S. Appl. No. 29/411,309, filed Jan. 19, 2012 (First Named Inventor—Dunn) (6 pages).

Notice of Allowance entered by the U.S. Patent and Trademark Office on Apr. 4, 2012 for U.S. Appl. No. 29/411,311, filed Jan. 19, 2012 (First Named Inventor—Dunn) (7 pages).

Specification, Claims, and Drawings entered by the U.S. Patent and Trademark Office on Jan. 19, 2012 for U.S. Appl. No. 29/411,277, filed Jan. 19, 2012 (First Named Inventor—Dunn) (7 pages).

Notice of Allowance and Fees Due entered by the U.S. Patent and Trademark Office on Mar. 2, 2012 for U.S. Appl. No. 29/411,277, filed Jan. 19, 2012 (First Named Inventor—Dunn) (7 pages).

Specification, Claims, and Drawings entered by the U.S. Patent and Trademark Office on Jan. 19, 2012 for U.S. Appl. No. 29/411,282, filed Jan. 19, 2012 (First Named Inventor—Dunn) (8 pages).

Notice of Allowance and Fees Due entered by the U.S. Patent and Trademark Office on Mar. 20, 2012 for U.S. Appl. No. 29/411,296, filed Jan. 19, 2012 (First Named Inventor—Dunn) (7 pages).

* cited by examiner

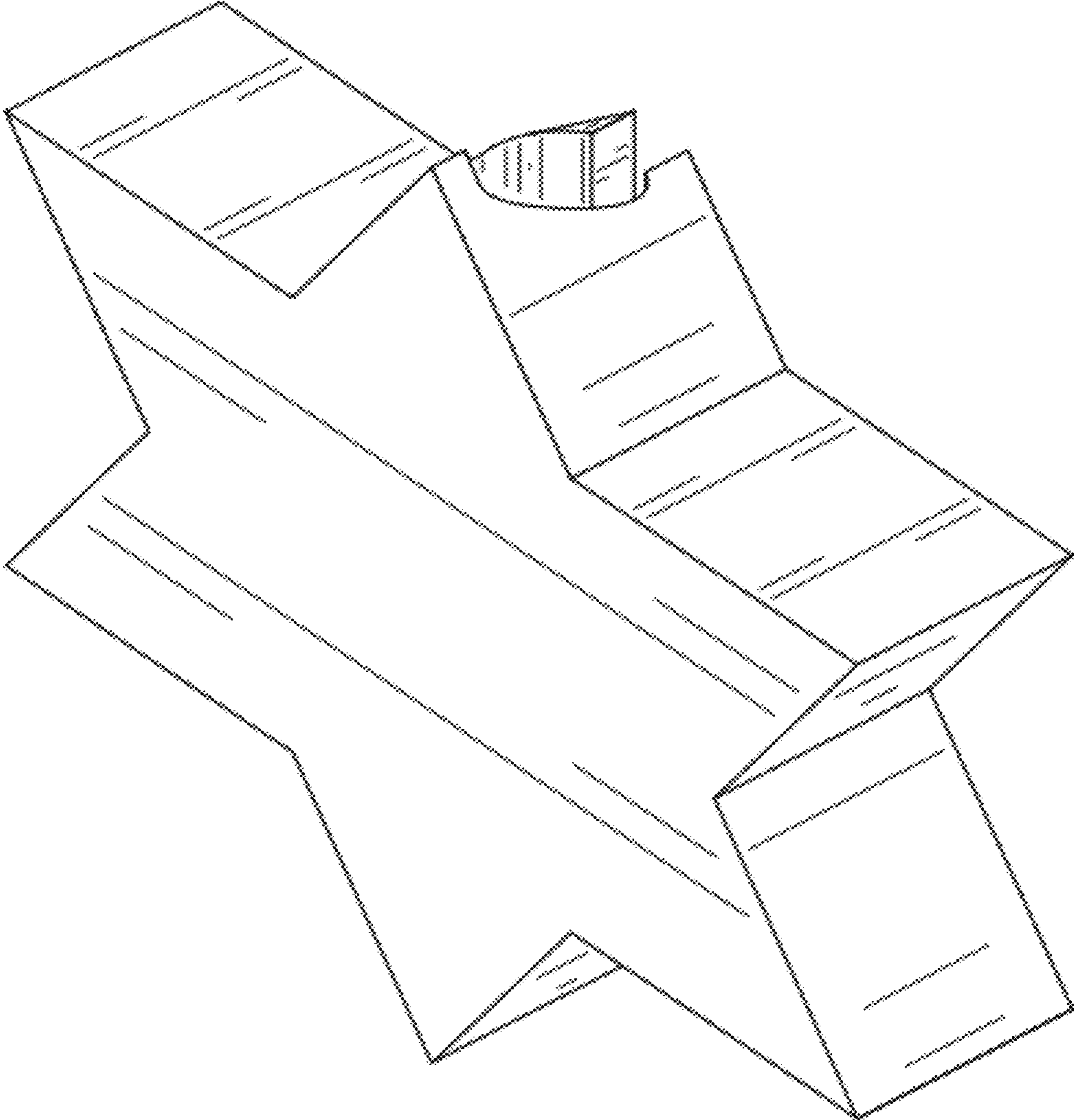

FIG. 1

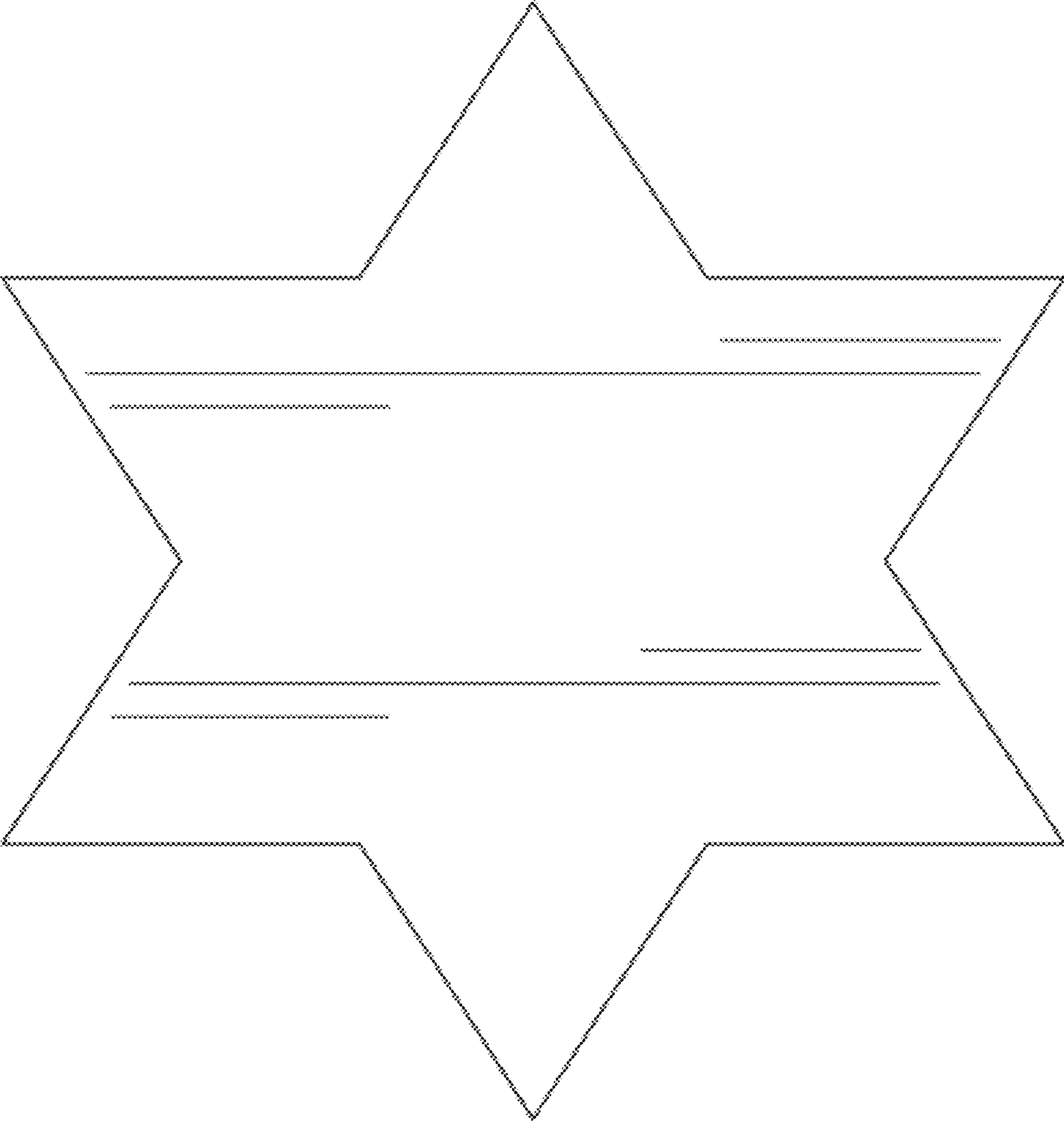

FIG. 2

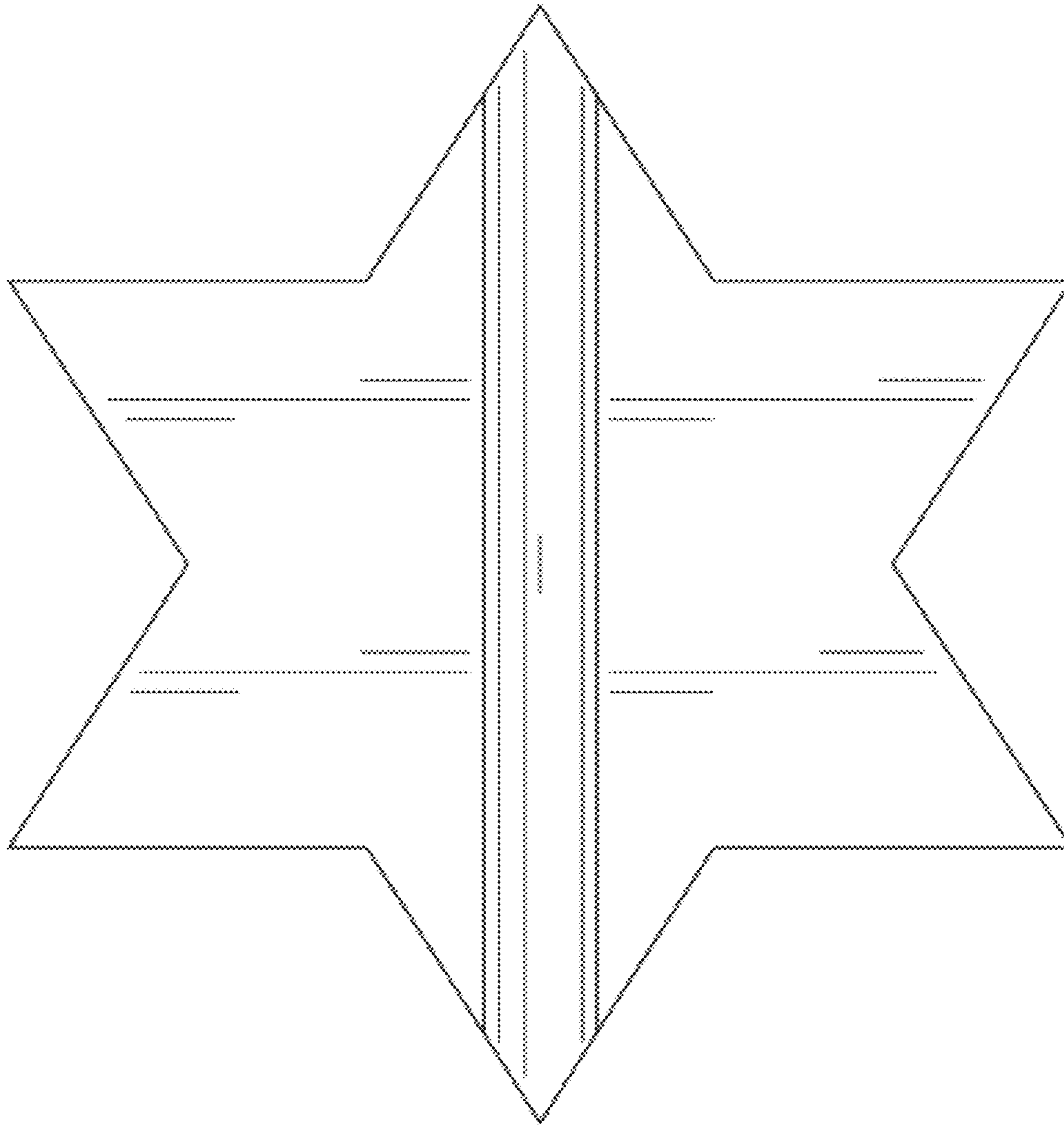

FIG. 3

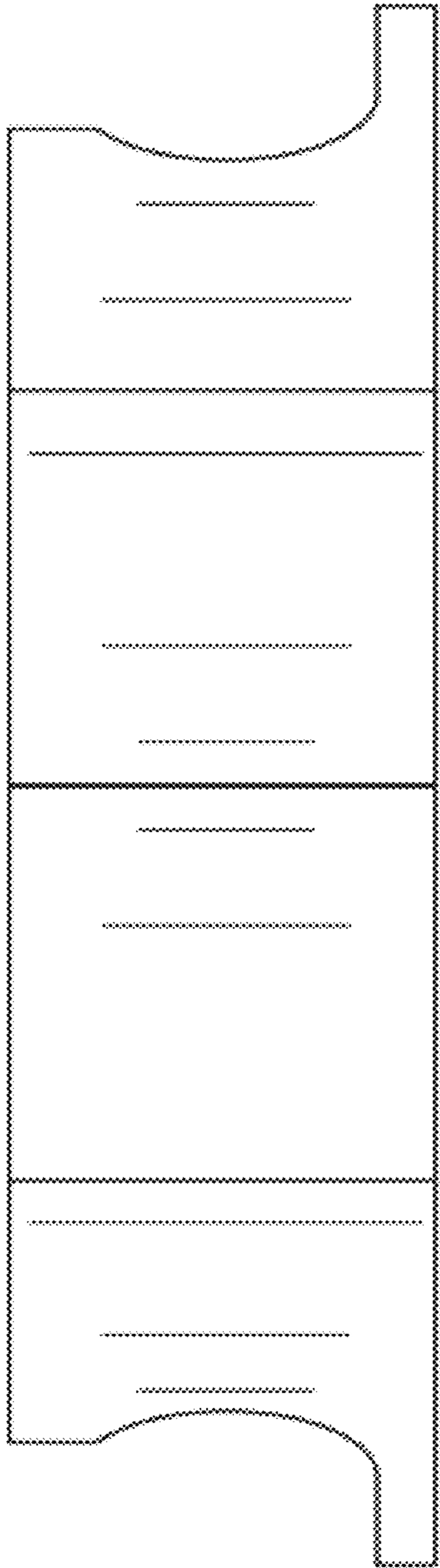

FIG. 4

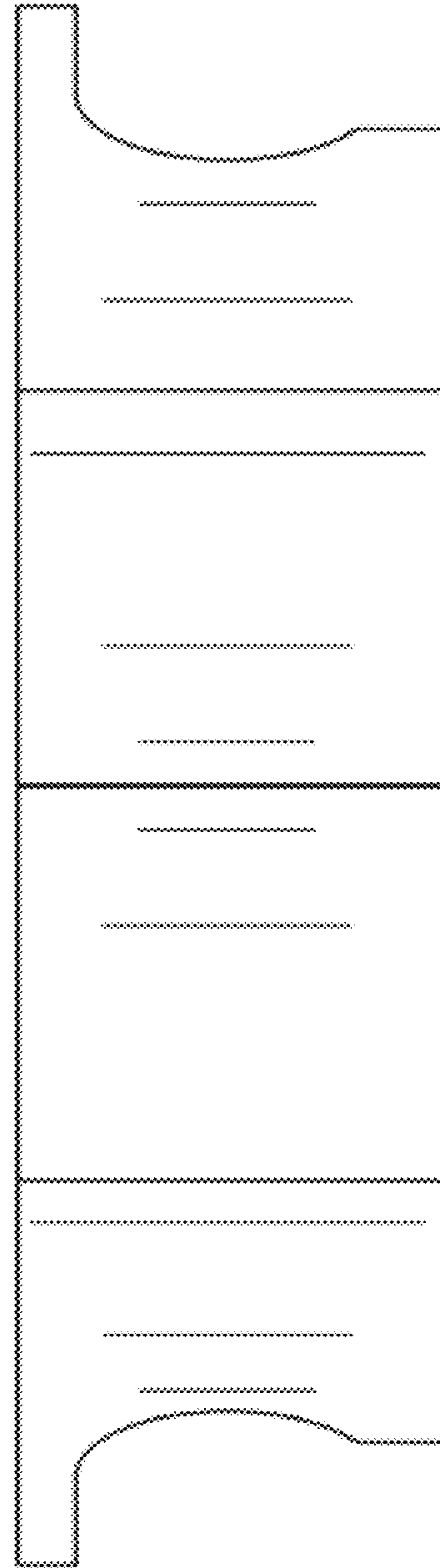

FIG. 5

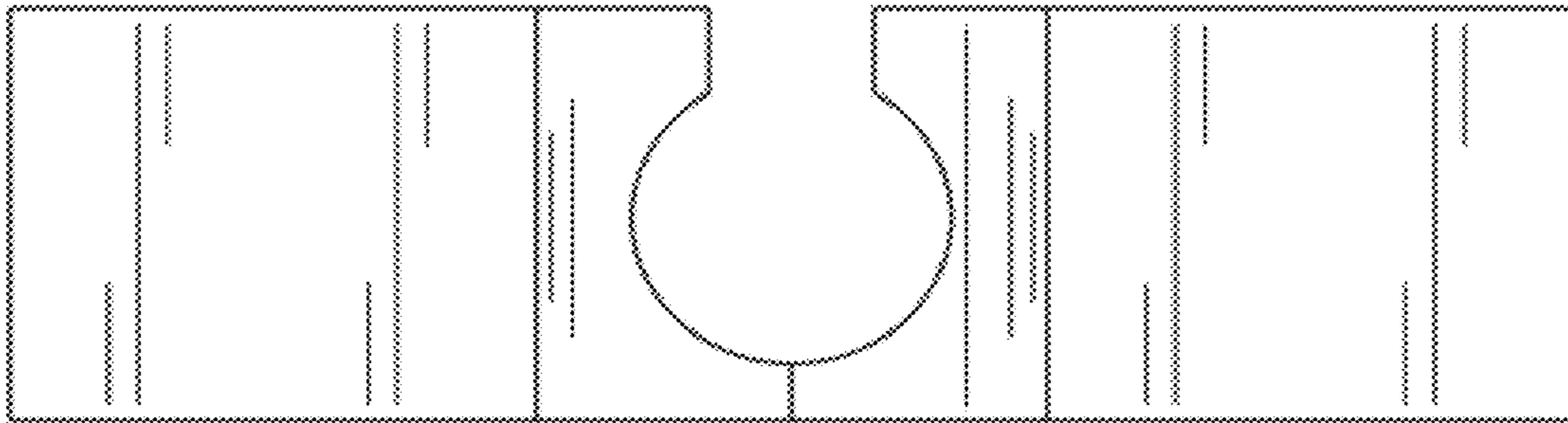

FIG. 6

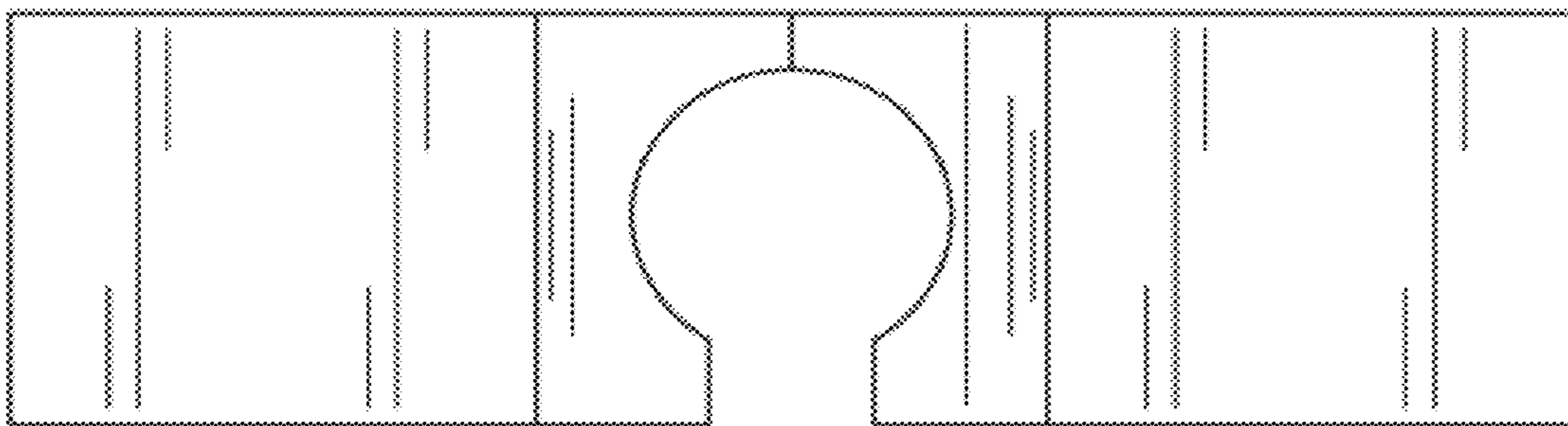

FIG. 7