



US00D666091S

(12) **United States Design Patent**
Klopp et al.

(10) **Patent No.:** **US D666,091 S**
(45) **Date of Patent:** **** Aug. 28, 2012**

(54) **FEMININE HYGIENE PRODUCT PACKAGE WITH SURFACE GRAPHICS**

DESCRIPTION

(75) Inventors: **Nora Elena Klopp**, Cincinnati, OH (US); **Emma Sherras Bracey**, London (GB)

(73) Assignee: **The Procter & Gamble Company**, Cincinnati, OH (US)

(**) Term: **14 Years**

(21) Appl. No.: **29/364,769**

(22) Filed: **Jun. 28, 2010**

(51) **LOC (9) Cl.** **09-07**

(52) **U.S. Cl.** **D9/434**

(58) **Field of Classification Search** D9/692,
D9/685, 682, 669, 667, 631, 451, 450, 448,
D9/434, 432, 430, 414; D23/226, 225; 239/526,
239/492, 333, 112; 222/402.15, 402.13,
222/383.1, 334, 331, 321.8, 182

See application file for complete search history.

(56) **References Cited**

U.S. PATENT DOCUMENTS

D383,669 S *	9/1997	Taylor	D9/669
D475,615 S *	6/2003	Podlucky	D9/669
D494,863 S *	8/2004	Hamuro et al.	D9/432
D496,859 S *	10/2004	Hamuro et al.	D9/432
D522,856 S *	6/2006	Hamuro et al.	D9/432
D524,156 S *	7/2006	Hamuro et al.	D9/432
D526,194 S *	8/2006	Hamuro et al.	D9/432
D527,253 S *	8/2006	Hamuro et al.	D9/432
D543,110 S *	5/2007	Harada et al.	D9/457
D600,548 S *	9/2009	Seol et al.	D9/432
D603,701 S *	11/2009	Seol et al.	D9/432
D644,513 S *	9/2011	Marotti et al.	D9/434
D650,273 S *	12/2011	Tekulve et al.	D9/432

* cited by examiner

Primary Examiner — Susan Bennett Hattan

(74) *Attorney, Agent, or Firm* — Amanda T. Barry; Jason J. Camp

(57) **CLAIM**

The ornamental design for feminine hygiene product package with surface graphics, as shown and described.

The patent or application file contains at least one drawing executed in color. Copies of this patent or patent application publication with color drawing(s) will be provided by the Office upon request and payment of the necessary fee.

FIG. 1 is a perspective view of a first embodiment of feminine hygiene product package with surface graphics showing our new design;

FIG. 2 is a front view of the feminine hygiene product package with surface graphics as shown in FIG. 1;

FIG. 3 is a left side view of the feminine hygiene product package with surface graphics as shown in FIG. 1;

FIG. 4 is a right side view of the feminine hygiene product package with surface graphics as shown in FIG. 1;

FIG. 5 is a top view of the feminine hygiene product package with surface graphics as shown in FIG. 1;

FIG. 6 is a bottom view of the feminine hygiene product package with surface graphics as shown in FIG. 1;

FIG. 7 is a back view of of the feminine hygiene product package with surface graphics as shown in FIG. 1;

FIG. 8 is a perspective view of a second embodiment of feminine hygiene product package with surface graphics showing our new design;

FIG. 9 is a front view of the feminine hygiene product package with surface graphics as shown in FIG. 8;

FIG. 10 is a left side view of the feminine hygiene product package with surface graphics as shown in FIG. 8;

FIG. 11 is a right side view of the feminine hygiene product package with surface graphics as shown in FIG. 8;

FIG. 12 is a top view of the feminine hygiene product package with surface graphics as shown in FIG. 8;

FIG. 13 is a bottom view of the feminine hygiene product package with surface graphics as shown in FIG. 8;

FIG. 14 is a back view of the feminine hygiene product package with surface graphics as shown in FIG. 8;

FIG. 15 is a perspective view of a third embodiment of feminine hygiene product package with surface graphics showing our new design;

FIG. 16 is a front view of the feminine hygiene product package with surface graphics as shown in FIG. 15;

FIG. 17 is a left side view of the feminine hygiene product package with surface graphics as shown in FIG. 15;

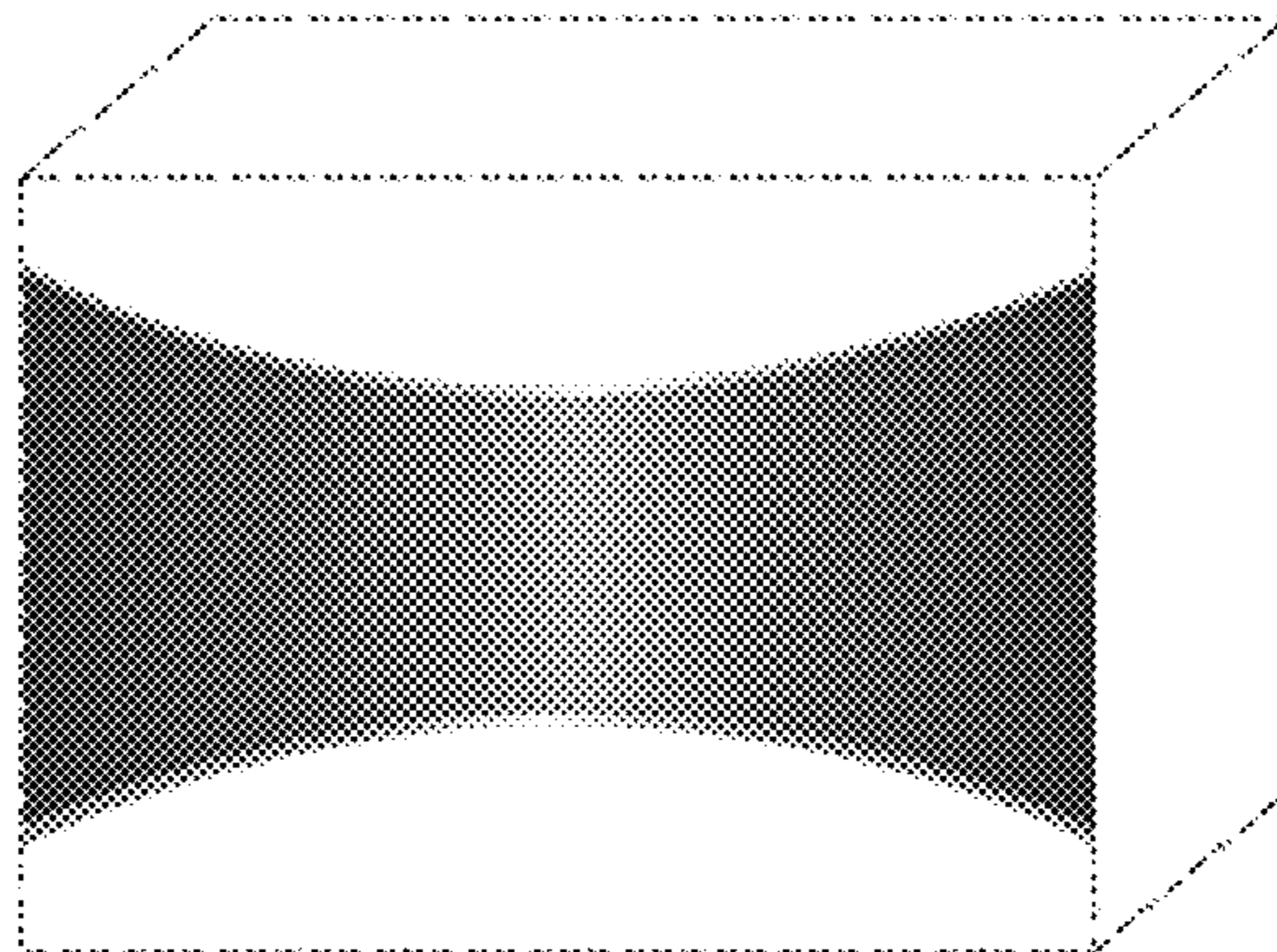

FIG. 18 is a right side view of the feminine hygiene product package with surface graphics as shown in FIG. 15;

FIG. 19 is a top view of the feminine hygiene product package with surface graphics as shown in FIG. 15;

FIG. 20 is a bottom view of the feminine hygiene product package with surface graphics as shown in FIG. 15;

FIG. 21 is a back view of the feminine hygiene product package with surface graphics as shown in FIG. 15;

FIG. 22 is a perspective view of a fourth embodiment of feminine hygiene product package with surface graphics showing our new design;

FIG. 23 is a front view of the feminine hygiene product package with surface graphics as shown in FIG. 22;

FIG. 24 is a left side view of the feminine hygiene product package with surface graphics as shown in FIG. 22;

FIG. 25 is a right side view of the feminine hygiene product package with surface graphics as shown in FIG. 22;

FIG. 26 is a top view of the feminine hygiene product package with surface graphics as shown in FIG. 22;

FIG. 27 is a bottom view of the feminine hygiene product package with surface graphics as shown in FIG. 22; and,

FIG. 28 is a back view of the feminine hygiene product package with surface graphics as shown in FIG. 22.

The broken lines shown depict environmental subject matter only and form no part of the claimed design.

**1 Claim, 28 Drawing Sheets
(6 of 28 Drawing Sheet(s) Filed in Color)**

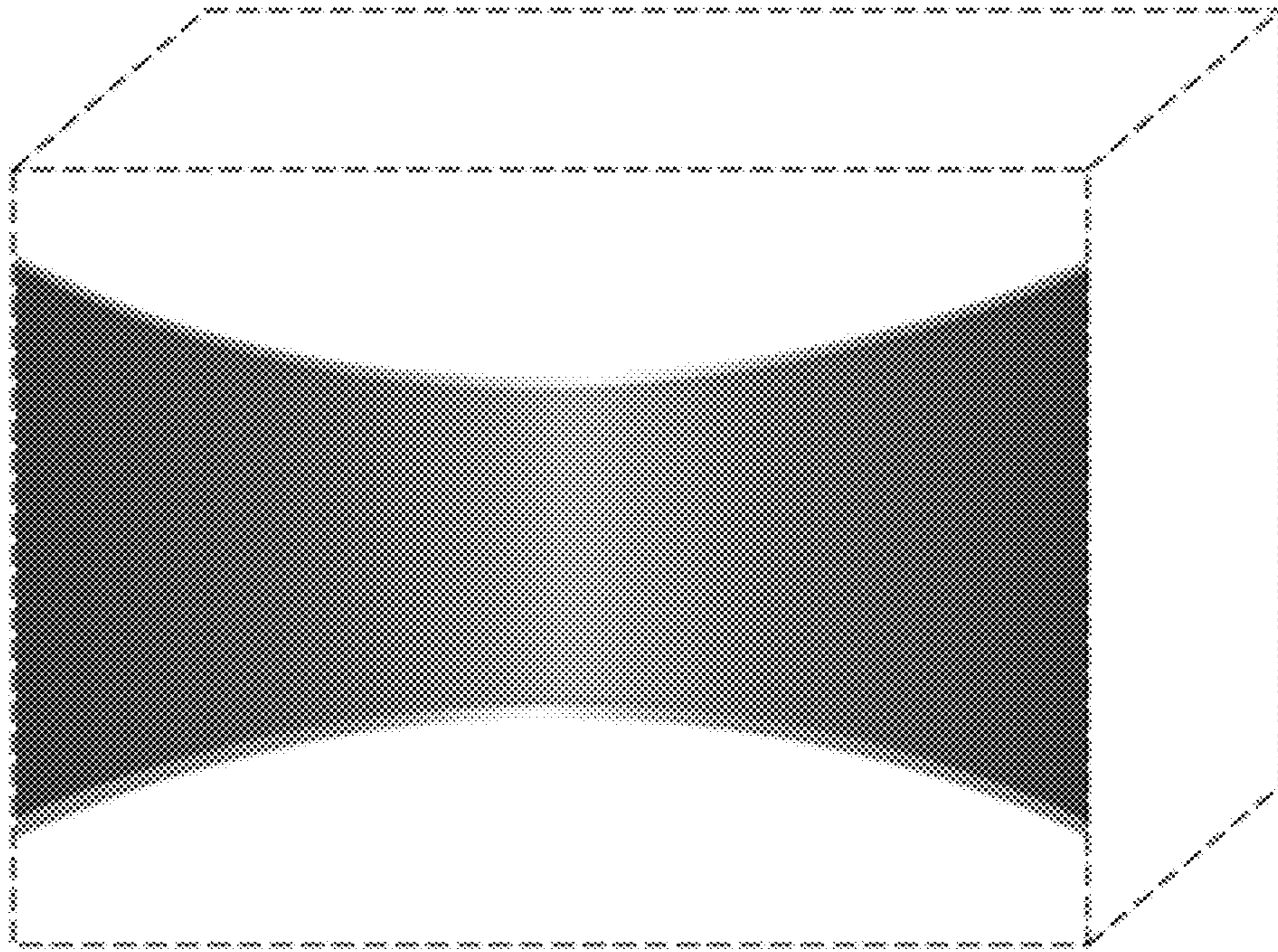

Fig. 1

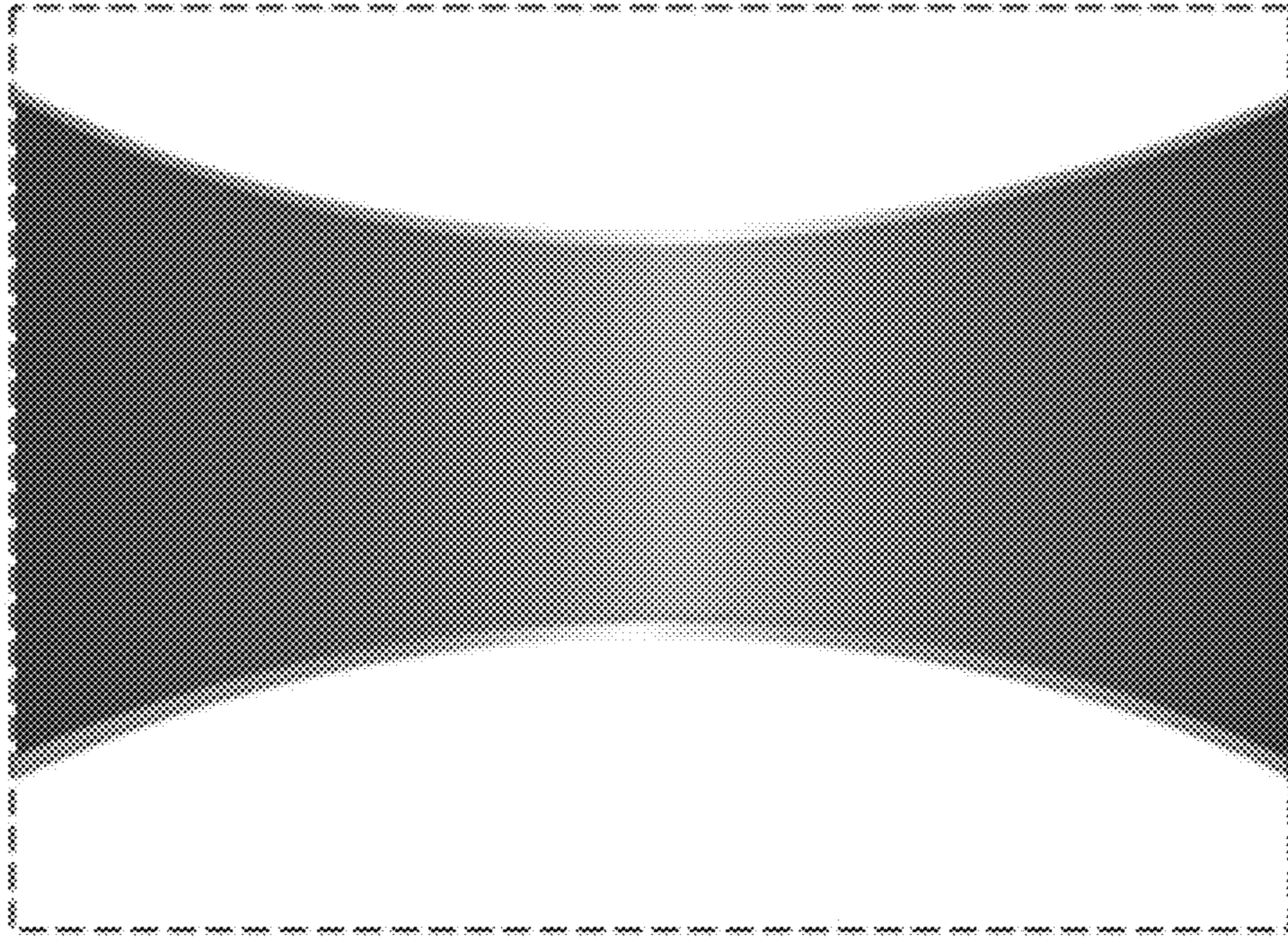

Fig. 2

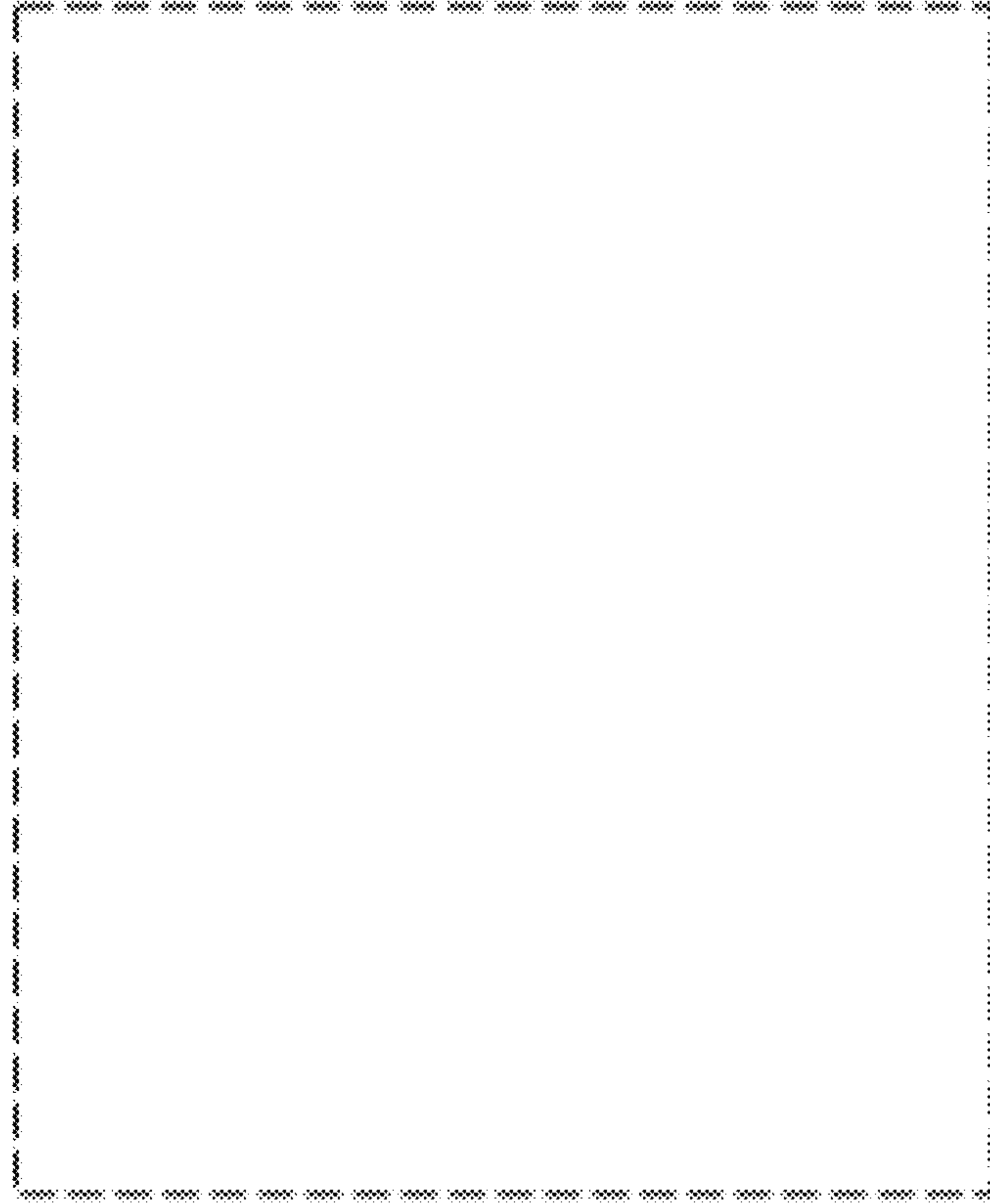

Fig. 3



Fig. 4



Fig. 5



Fig. 6



Fig. 7

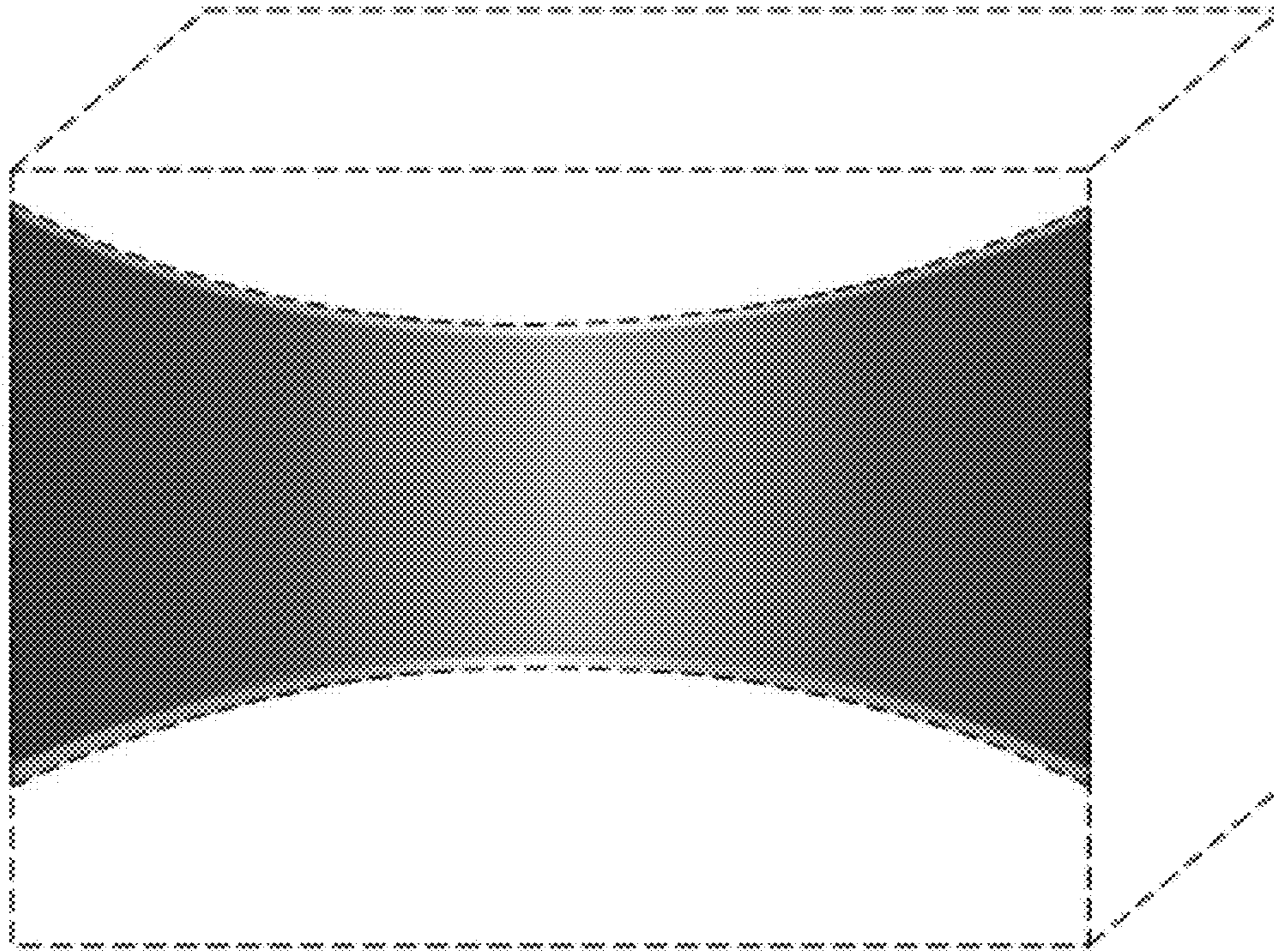

Fig. 8

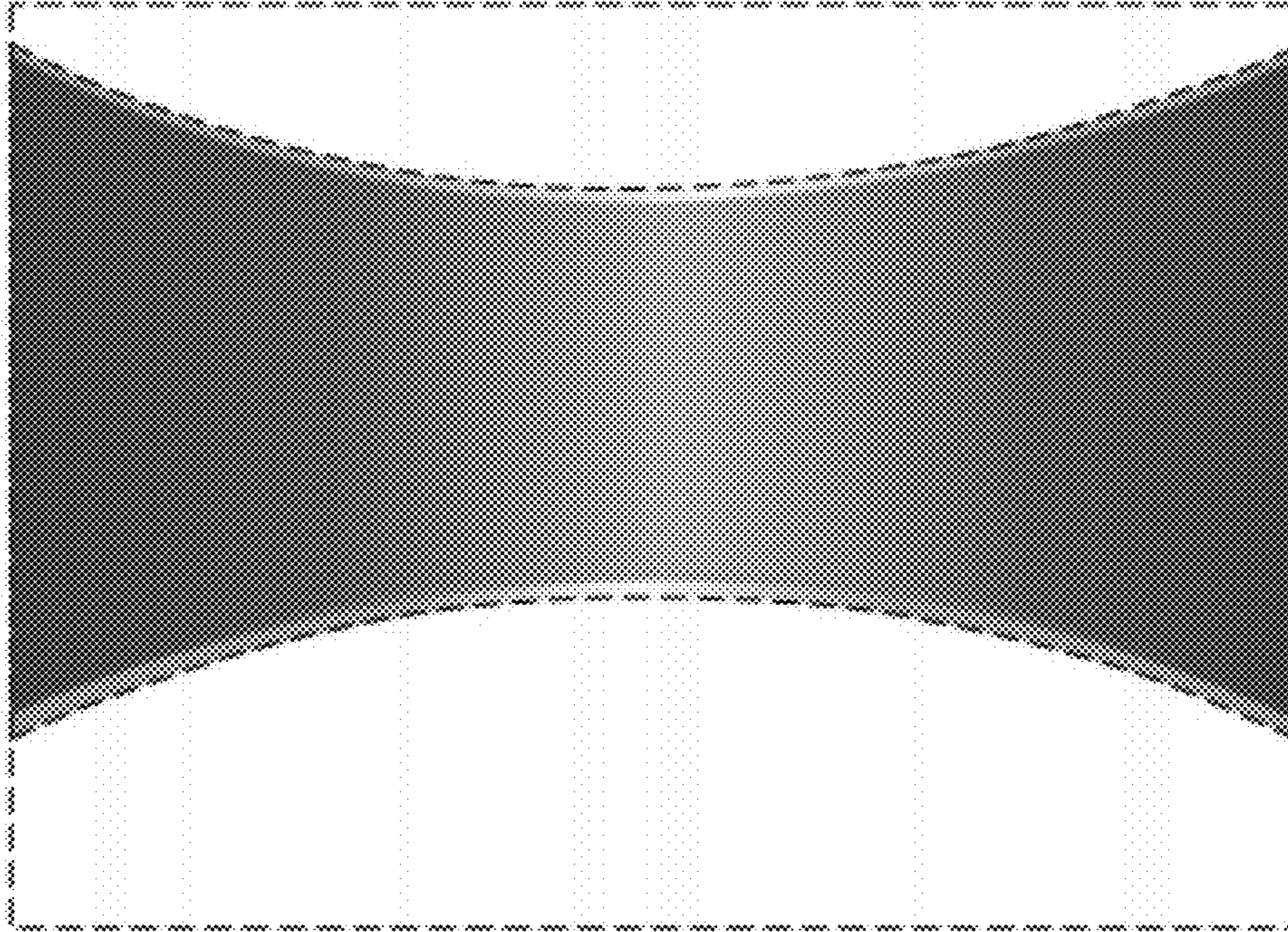

Fig. 9

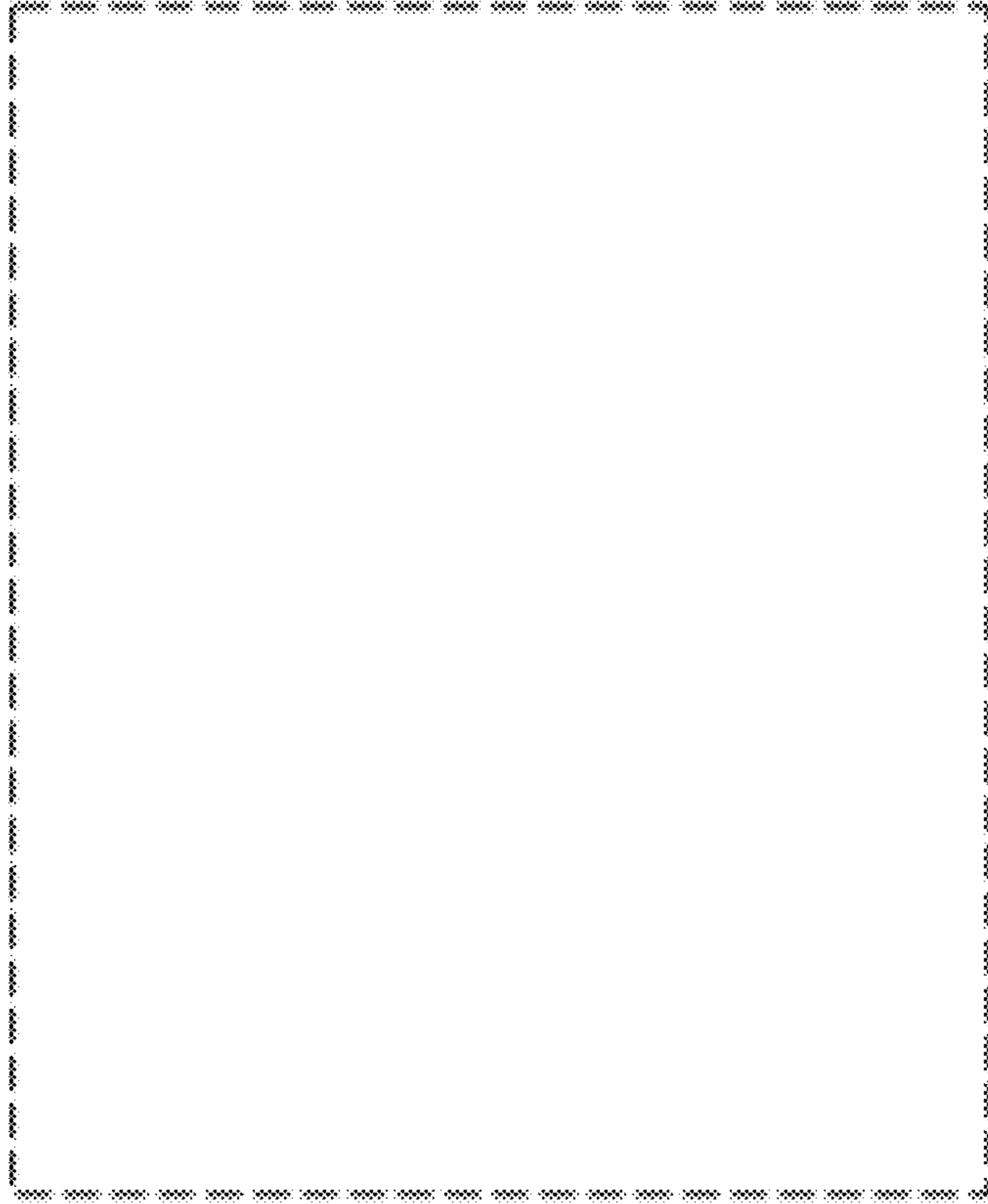

Fig. 10

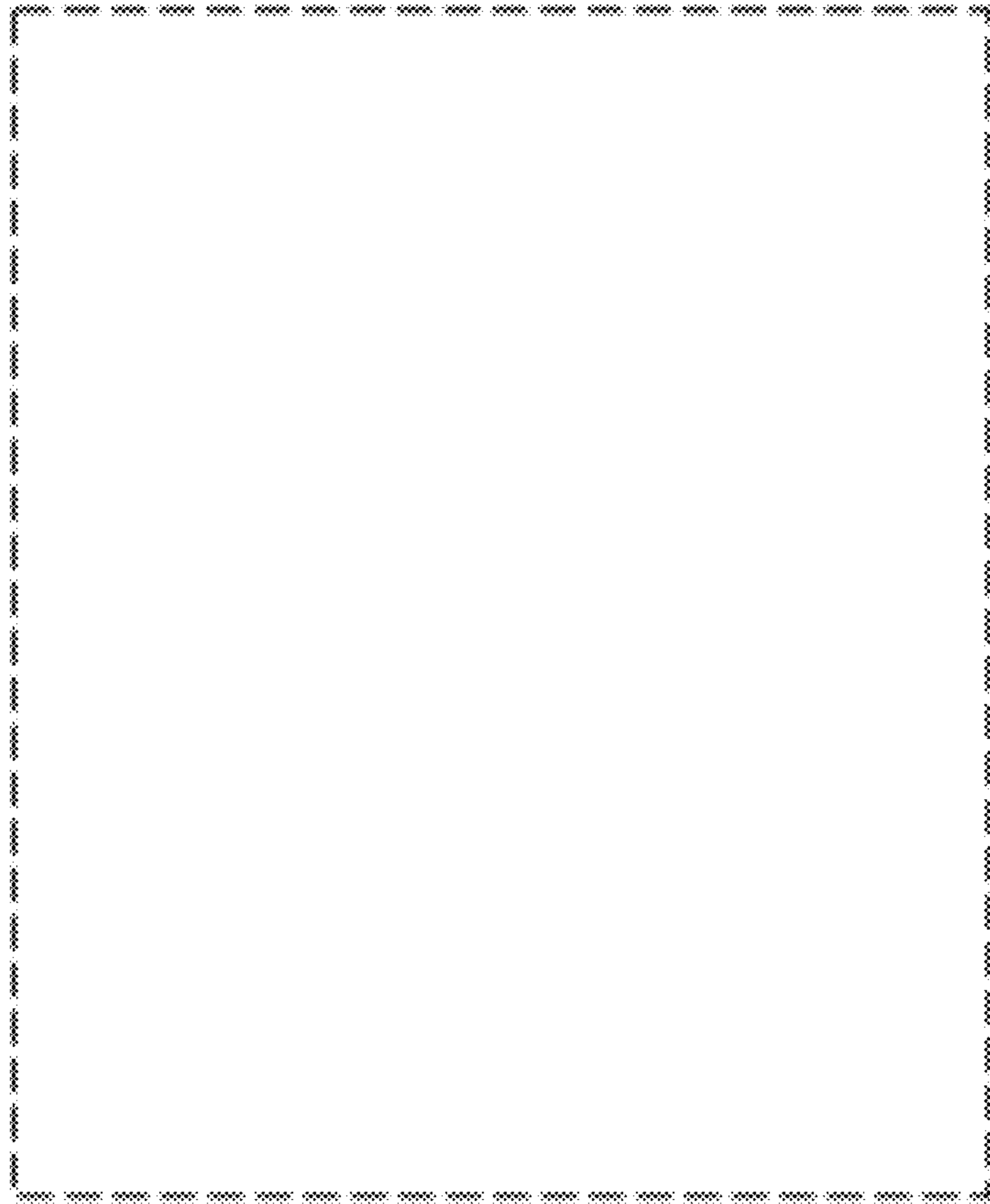

Fig. 11



Fig. 12



Fig. 13



Fig. 14

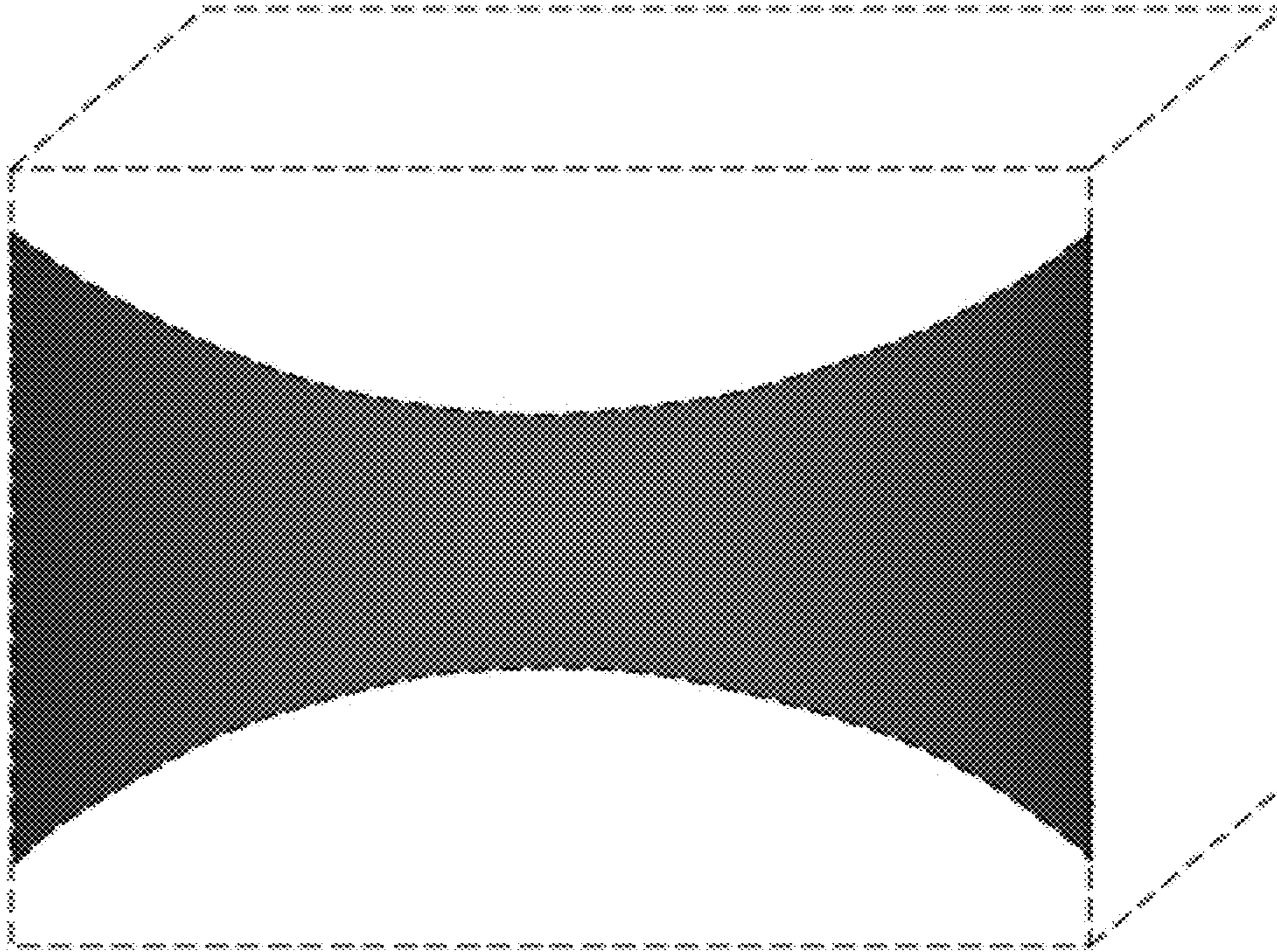

Fig. 15

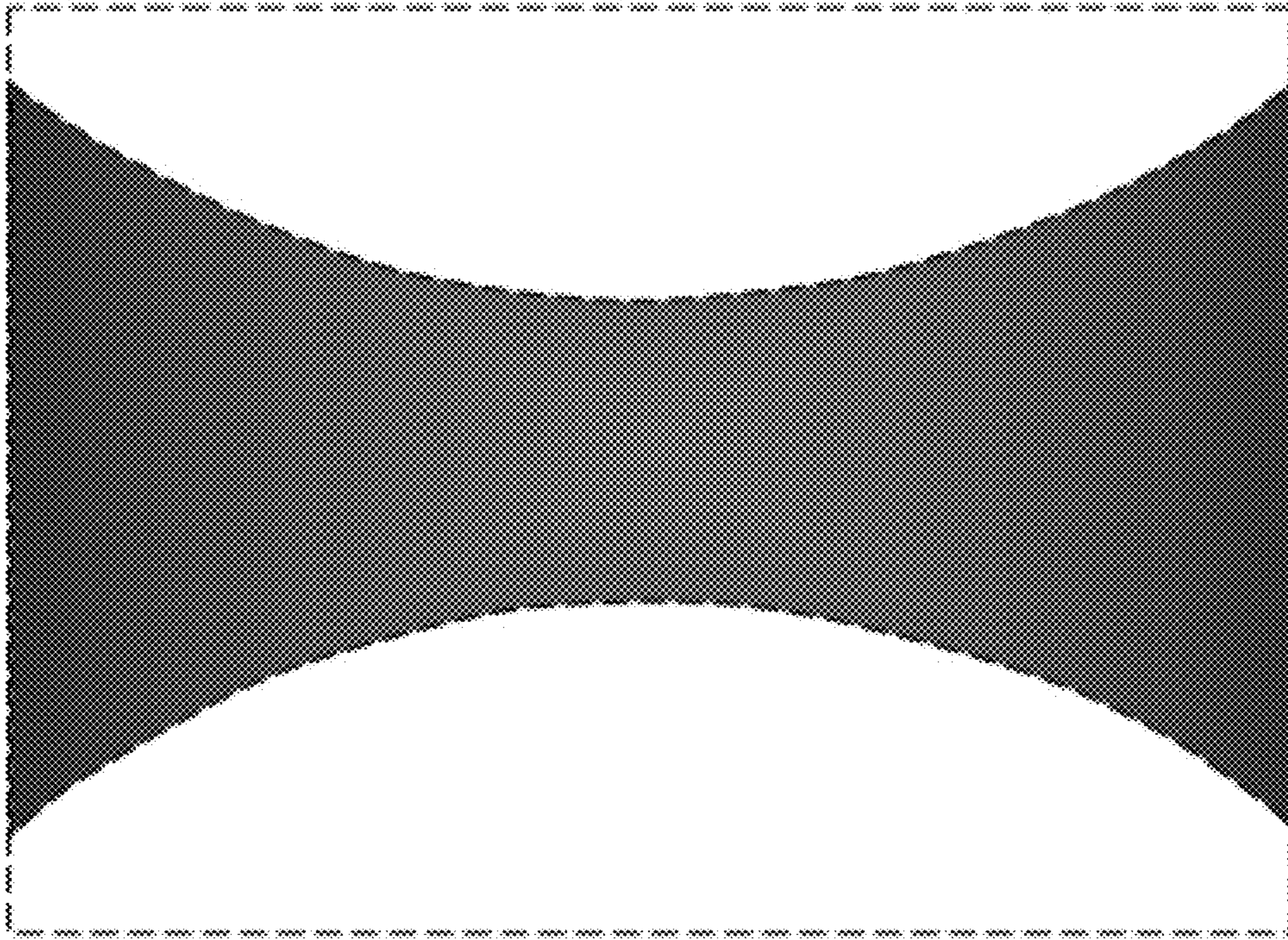

Fig. 16

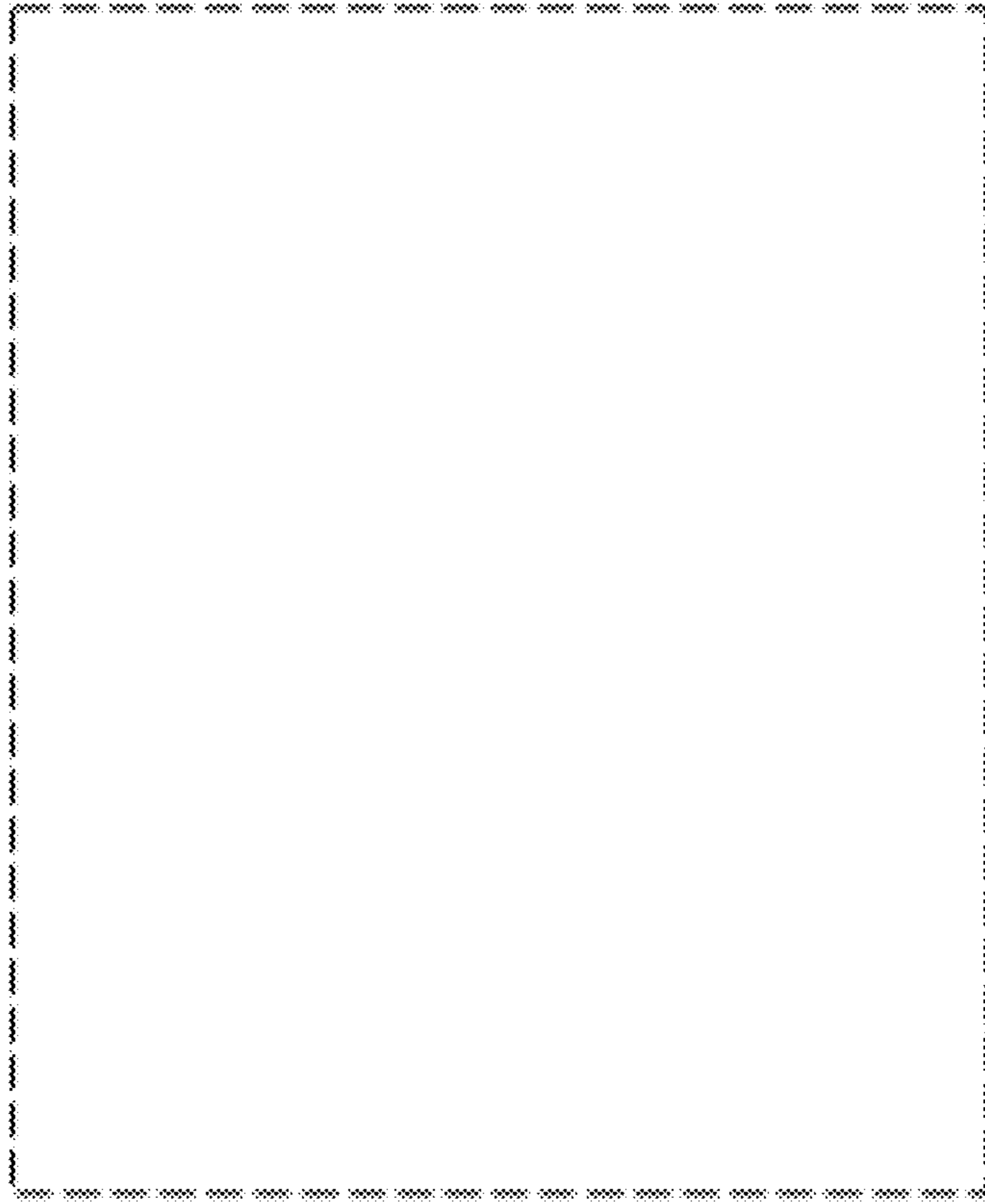

Fig. 17

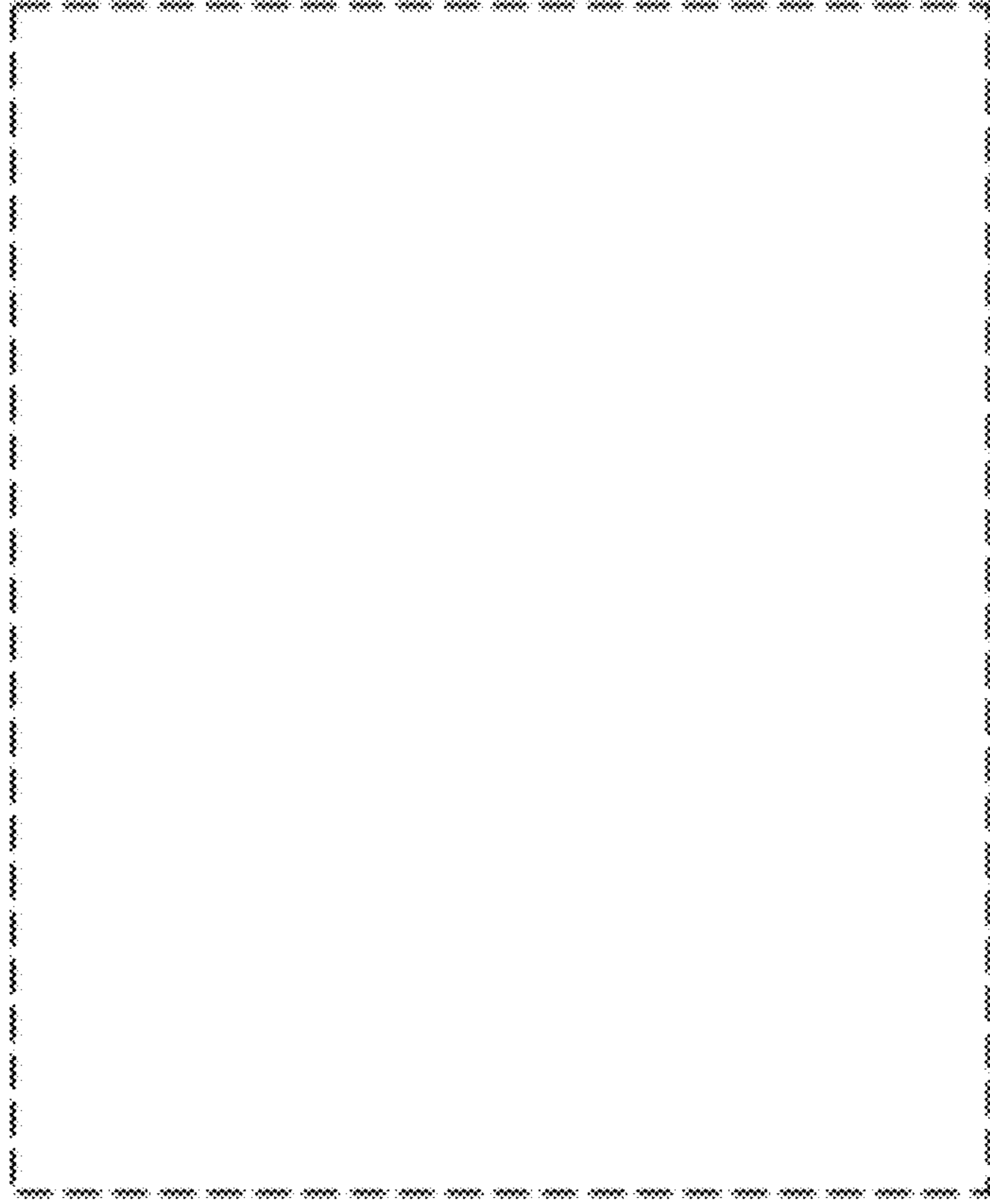

Fig. 18



Fig. 19



Fig. 20



Fig. 21

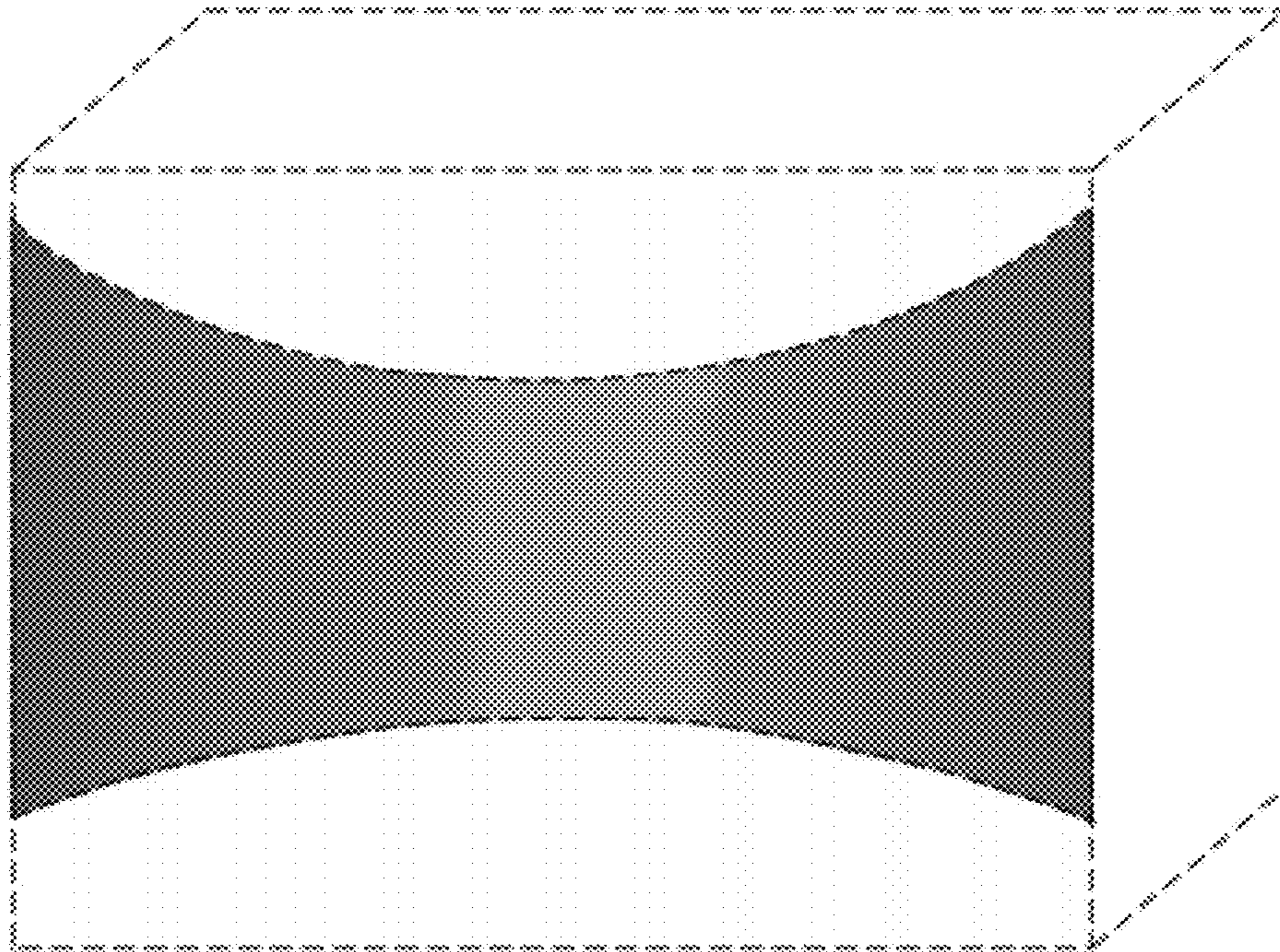

Fig. 22

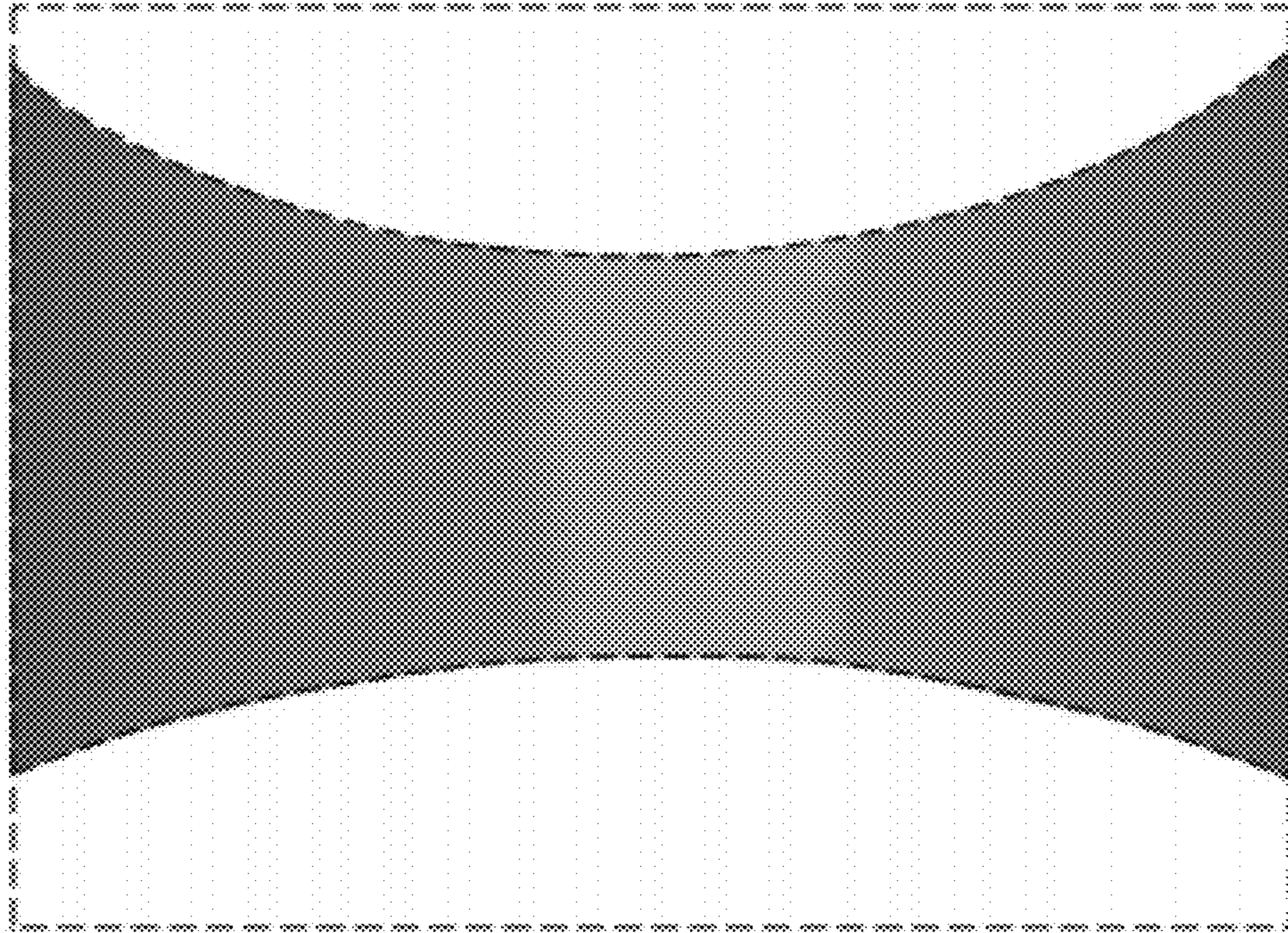

Fig. 23

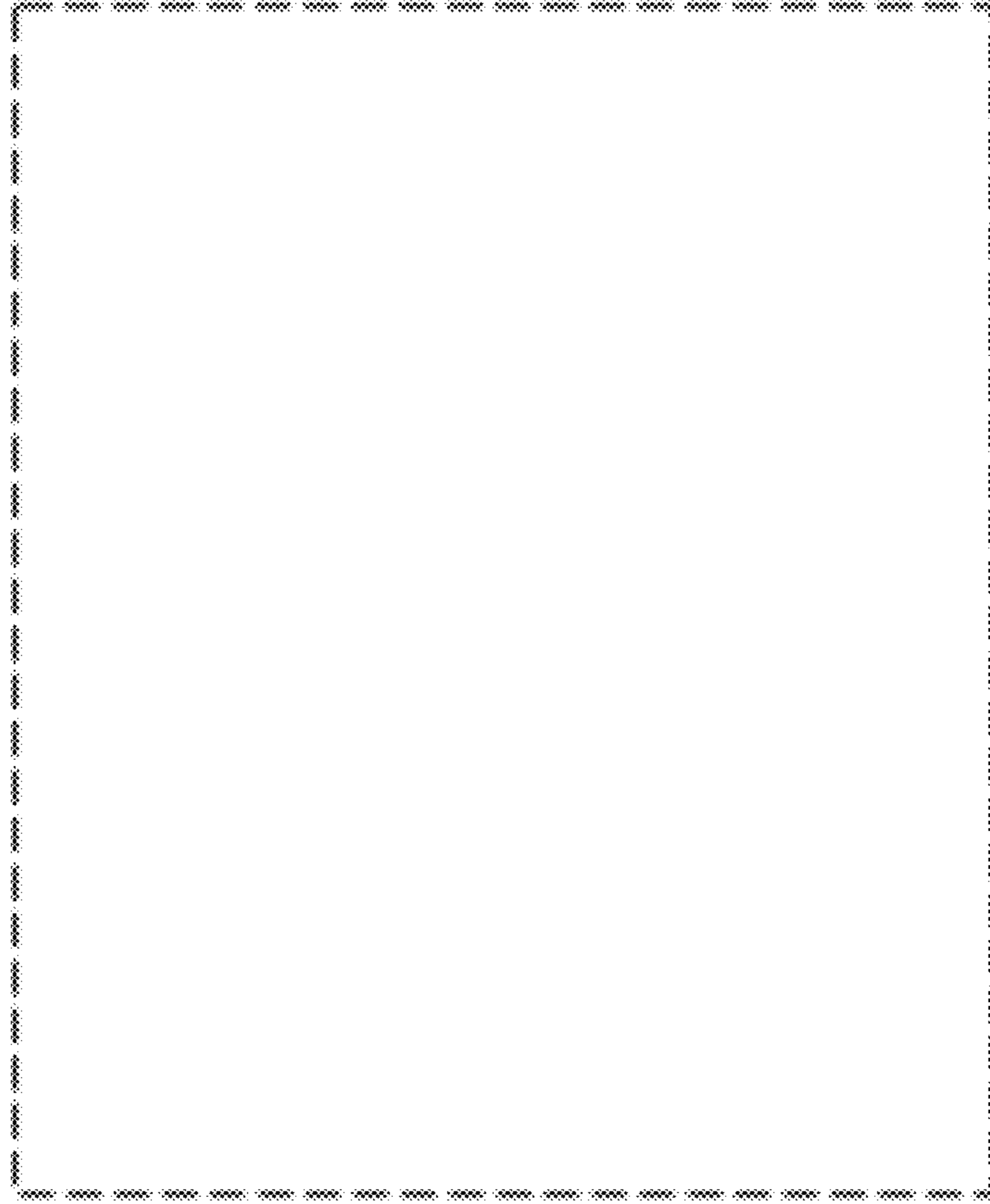

Fig. 24

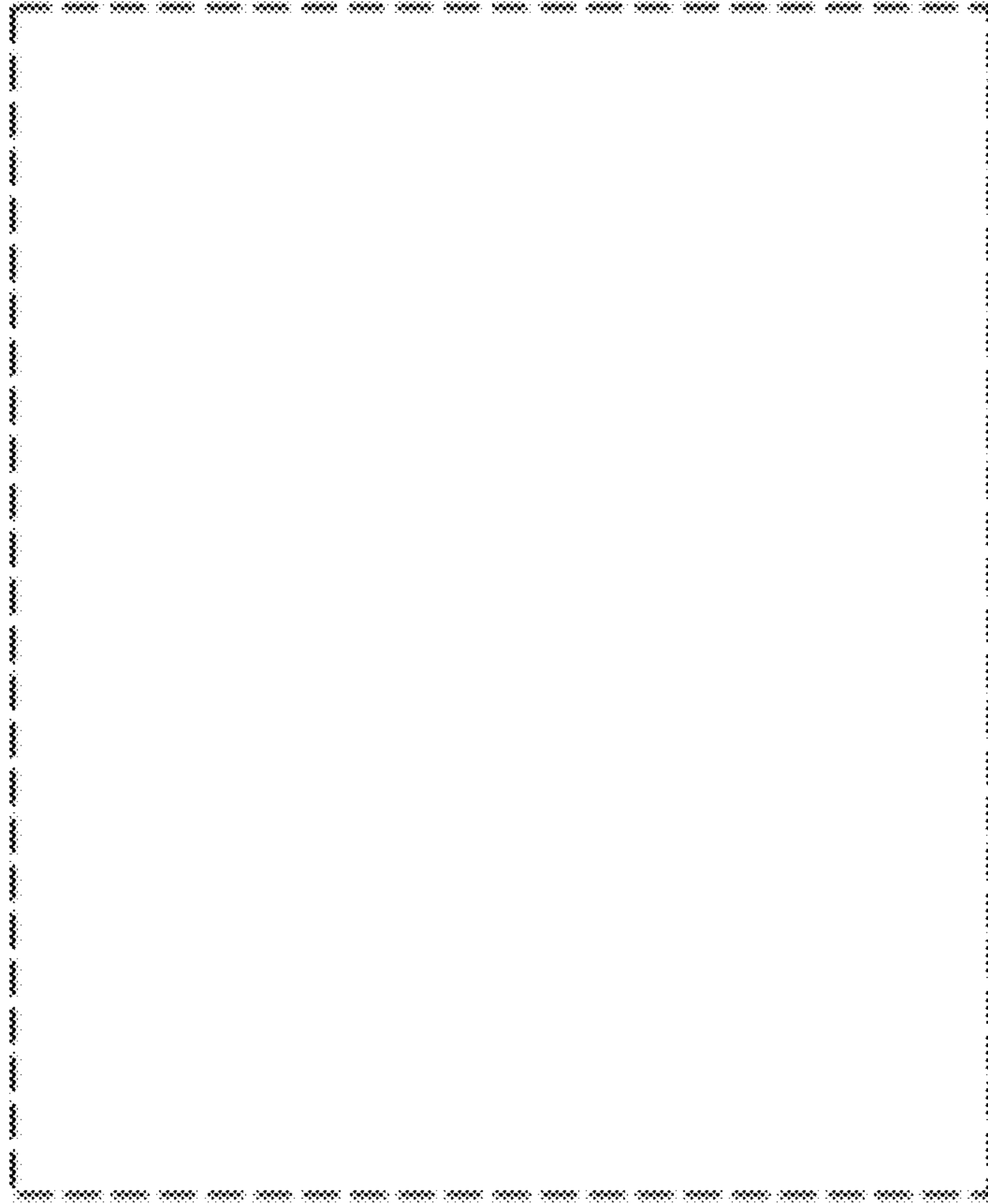

Fig. 25



Fig. 26



Fig. 27



Fig. 28