

US00D665977S

(12) **United States Design Patent**  
**Natkin**

(10) **Patent No.:** **US D665,977 S**

(45) **Date of Patent:** **\*\* Aug. 28, 2012**

(54) **FOLDABLE SHOE**

(75) Inventor: **Christine Natkin**, Paris (FR)

(73) Assignee: **Natkin Paris**, Paris (FR)

(\*\*) Term: **14 Years**

(21) Appl. No.: **29/389,666**

(22) Filed: **Apr. 14, 2011**

(30) **Foreign Application Priority Data**

Oct. 14, 2010 (FR) ..... 2010 5158

(51) **LOC (9) Cl.** ..... **02-04**

(52) **U.S. Cl.** ..... **D2/896; D2/925; D2/941**

(58) **Field of Classification Search** ..... D2/896,  
D2/919-922, 925-942, 946, 969, 971; 36/1,  
36/83, 8.3, 45-58, 104, 108, 76 R, 5.2, 9 R,  
36/10

See application file for complete search history.

(56) **References Cited**

**U.S. PATENT DOCUMENTS**

98,793	A *	1/1870	Palmer et al.	36/9 R
123,313	A *	1/1872	Washburn	36/9 R
D39,412	S *	7/1908	Ostrowsky	D2/919
1,520,708	A *	12/1924	Goldstein et al.	36/8.3
1,525,848	A *	2/1925	Bonaventure	36/8.3
1,655,198	A *	1/1928	Selva	36/8.3
D85,164	S *	9/1931	de Cristofaro	D2/932
D101,463	S *	10/1936	Joyce	D2/927
D140,325	S *	2/1945	Ingram	D2/919
D149,685	S *	5/1948	Sandler	D2/935
2,995,838	A *	8/1961	Servin	36/9 R

3,120,711	A *	2/1964	Scholl	36/9 R
3,148,378	A *	9/1964	Tibbitts	36/9 R
D338,093	S *	8/1993	Uhr	D2/930
D339,669	S *	9/1993	Miller	D2/919
D388,592	S *	1/1998	Minden	D2/919
D571,084	S *	6/2008	Comeau	D2/925
D571,548	S *	6/2008	Seamans	D2/971
D579,637	S *	11/2008	Liow	D2/925
D630,829	S *	1/2011	Weisner	D2/925
7,926,203	B2 *	4/2011	Wilkenfeld	36/8.3
D640,861	S *	7/2011	Wilkenfeld	D2/896

\* cited by examiner

*Primary Examiner* — Dominic Simone

(74) *Attorney, Agent, or Firm* — Christie, Parker & Hales, LLP

(57) **CLAIM**

The ornamental design for foldable shoe, as shown and described.

**DESCRIPTION**

FIG. 1 is front perspective view of the foldable shoe;

FIG. 2 is a top view thereof;

FIG. 3 is a left side view thereof;

FIG. 4 is a bottom view thereof;

FIG. 5 is a right side view thereof;

FIG. 6 is a front view thereof;

FIG. 7 is a rear view thereof; and,

FIG. 8 is a front perspective view of the foldable shoe in a folded position.

The broken lines shown in the stitching in the bottom view is for illustrative purpose only and forms no part of the claimed design.

**1 Claim, 7 Drawing Sheets**

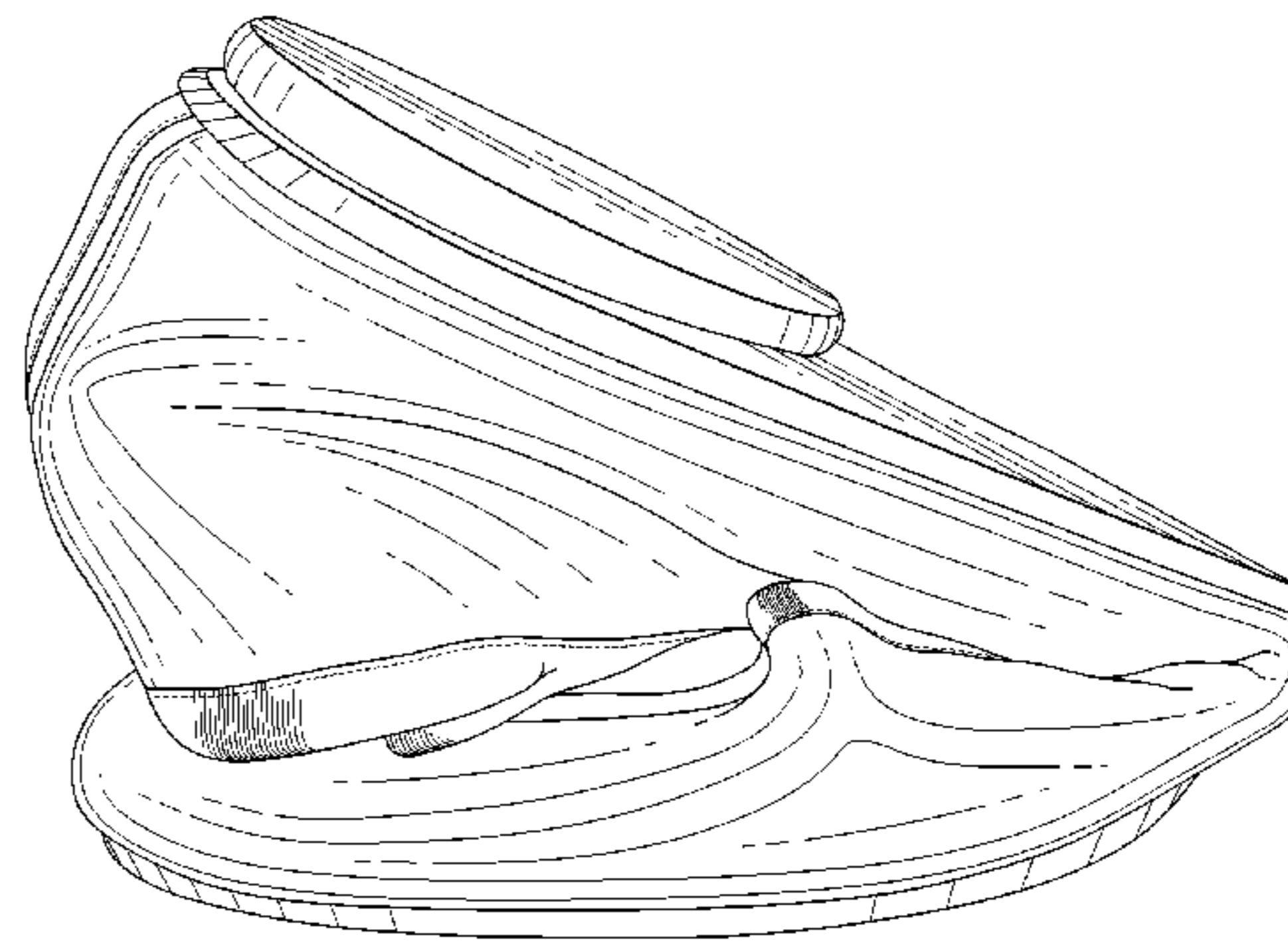
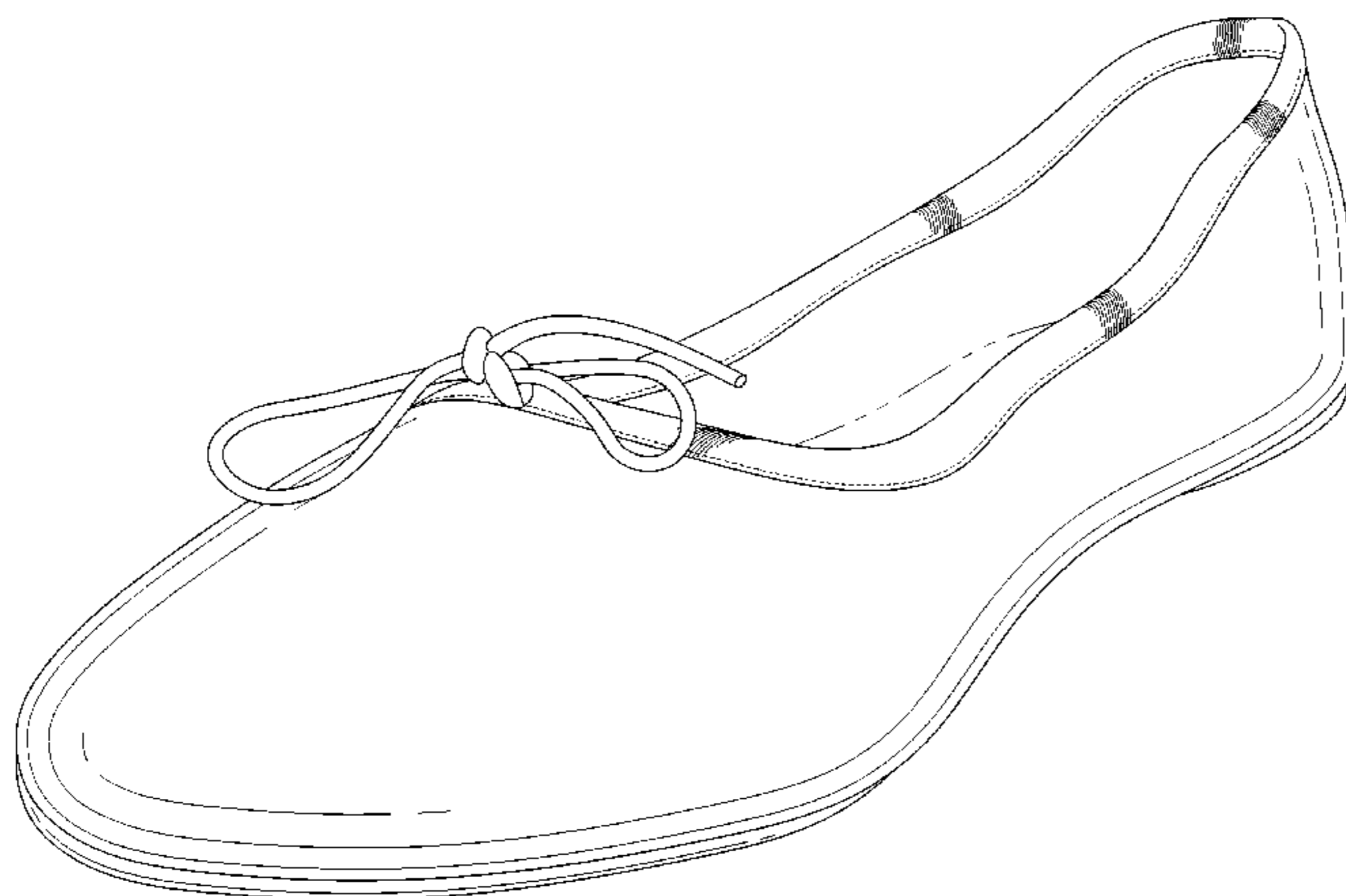

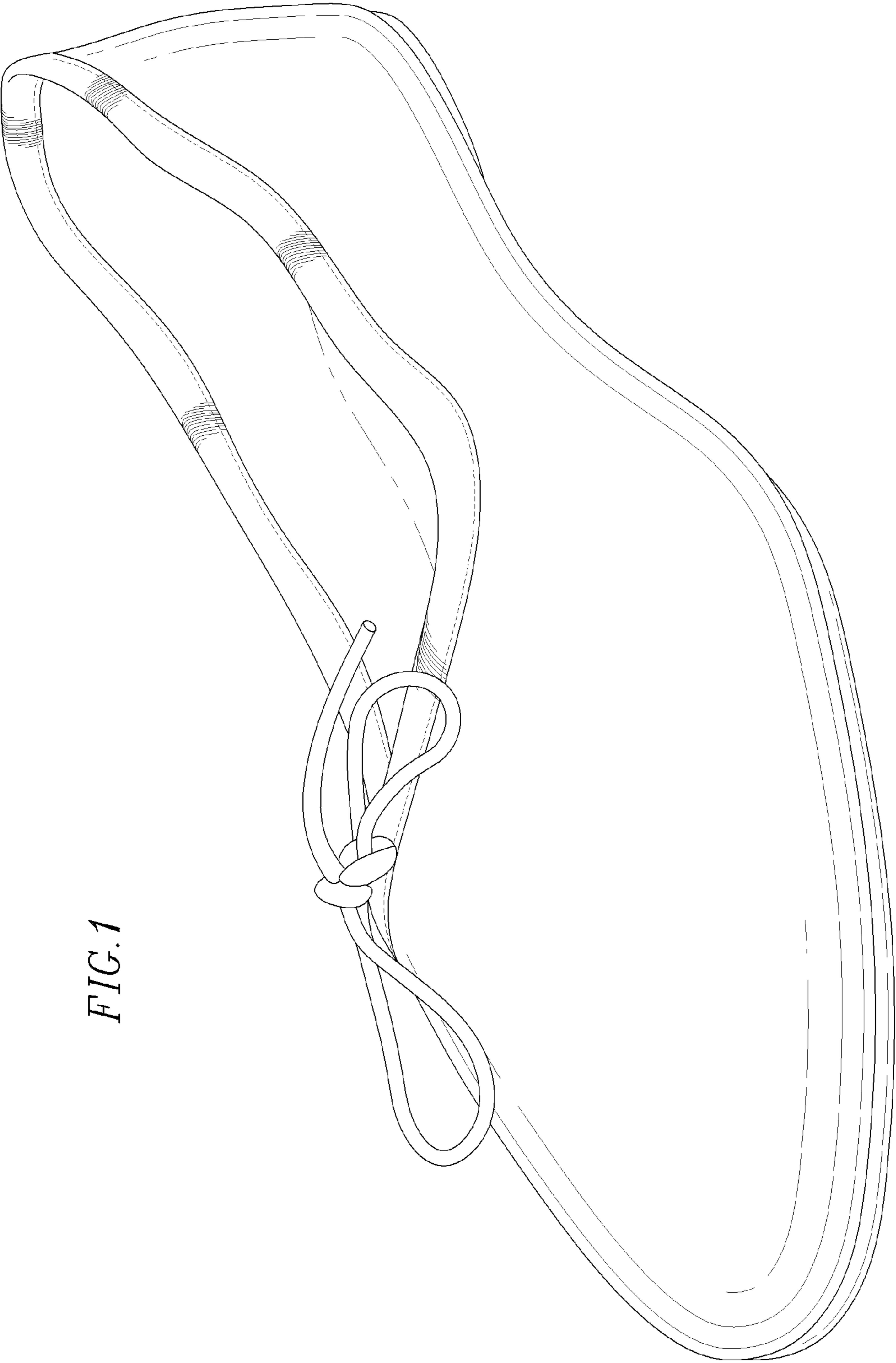

FIG. 1

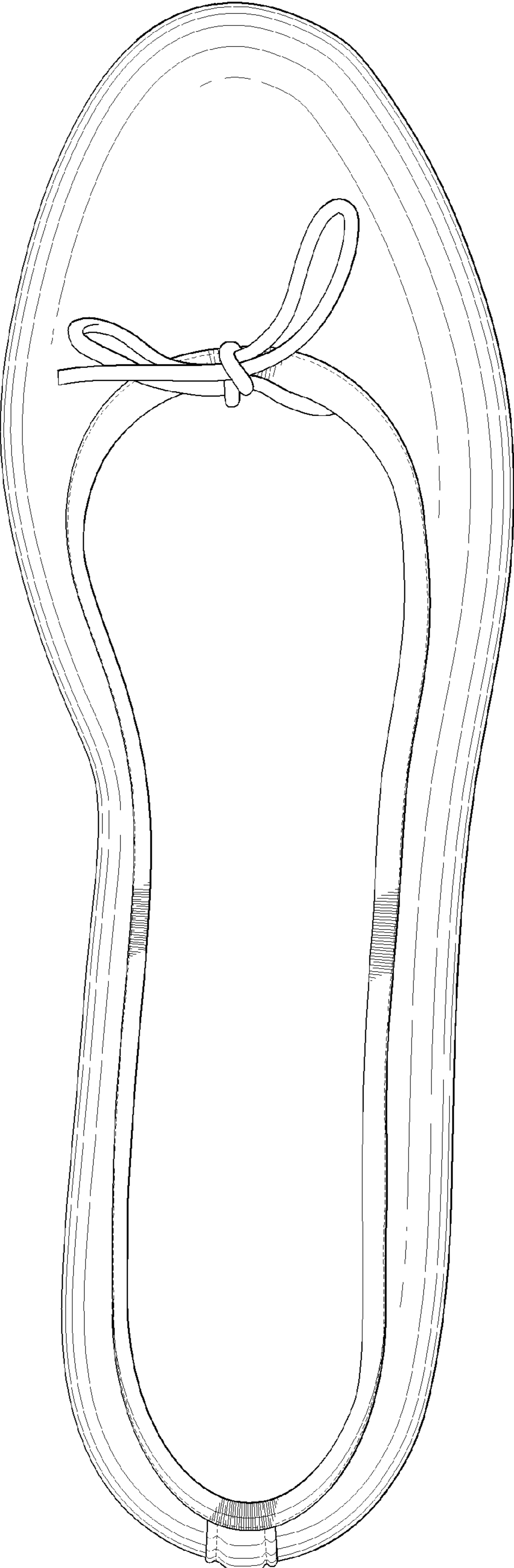

FIG. 2

FIG. 3

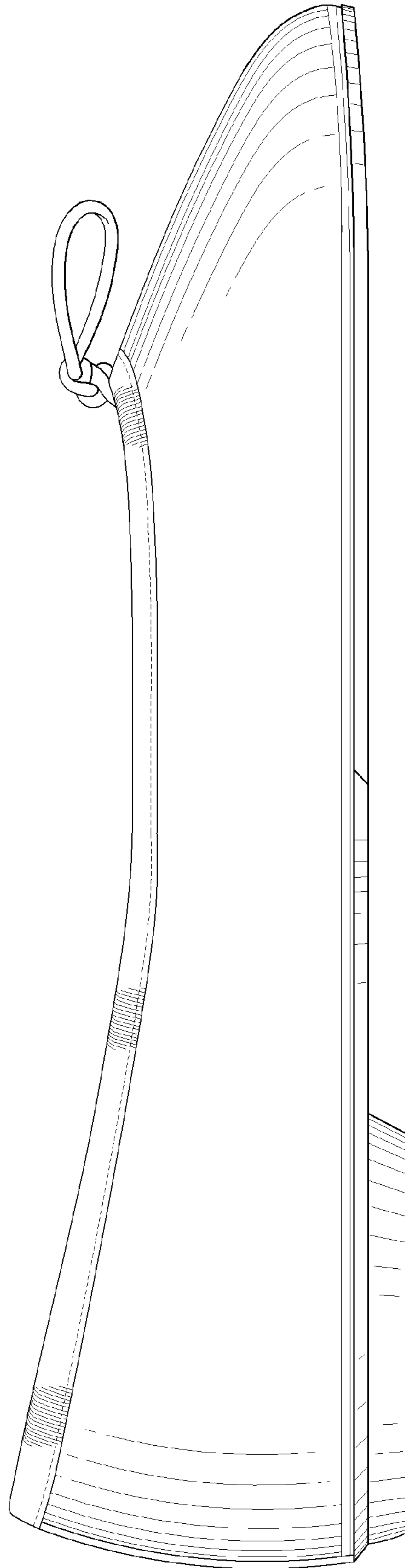

FIG. 4

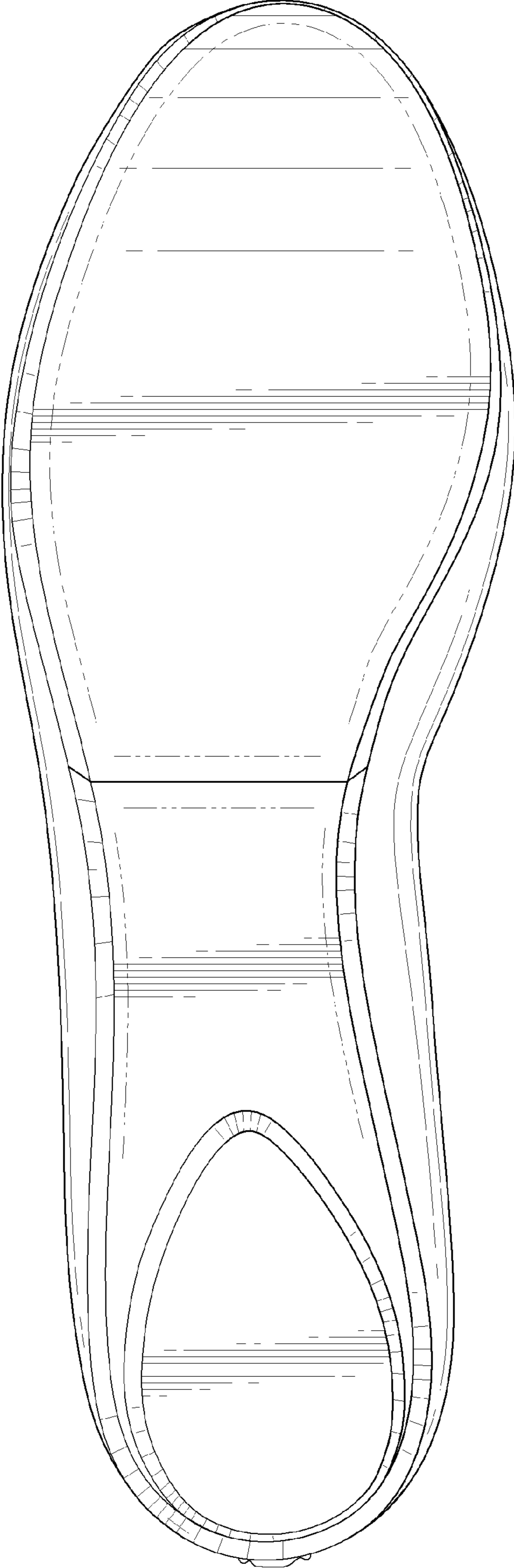

FIG. 5

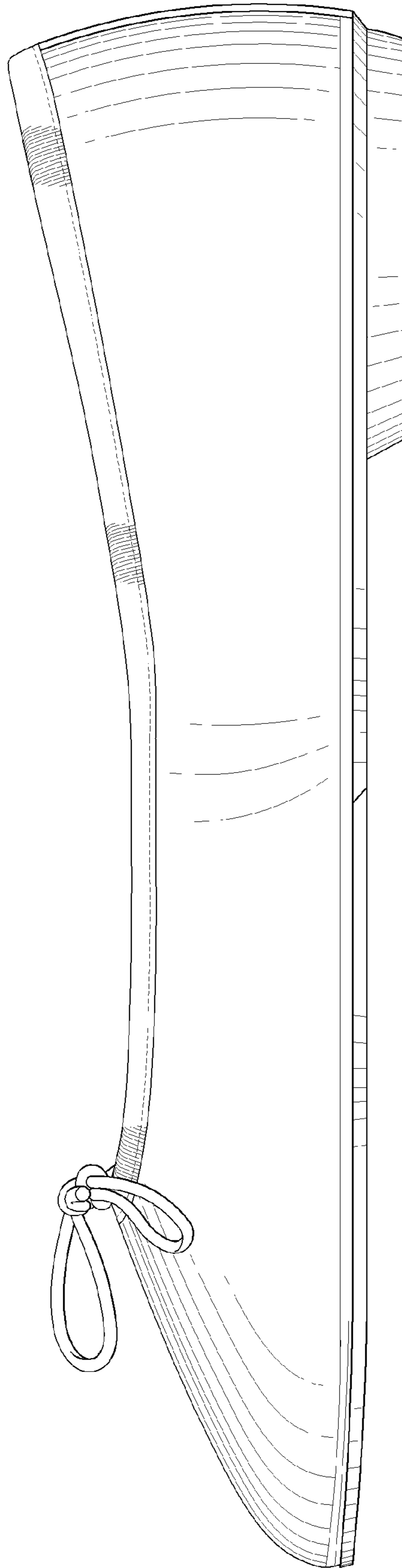

FIG. 7

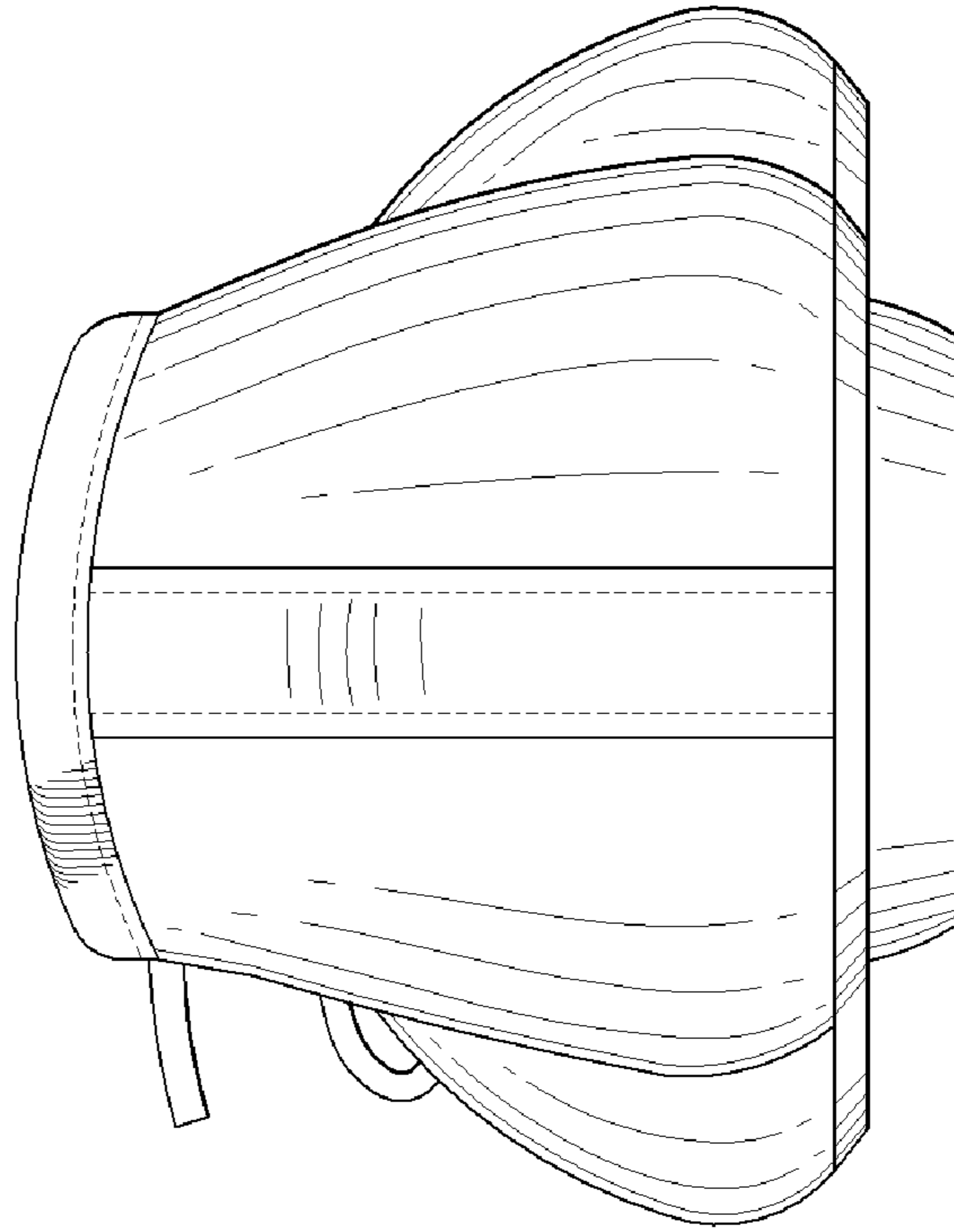

FIG. 6

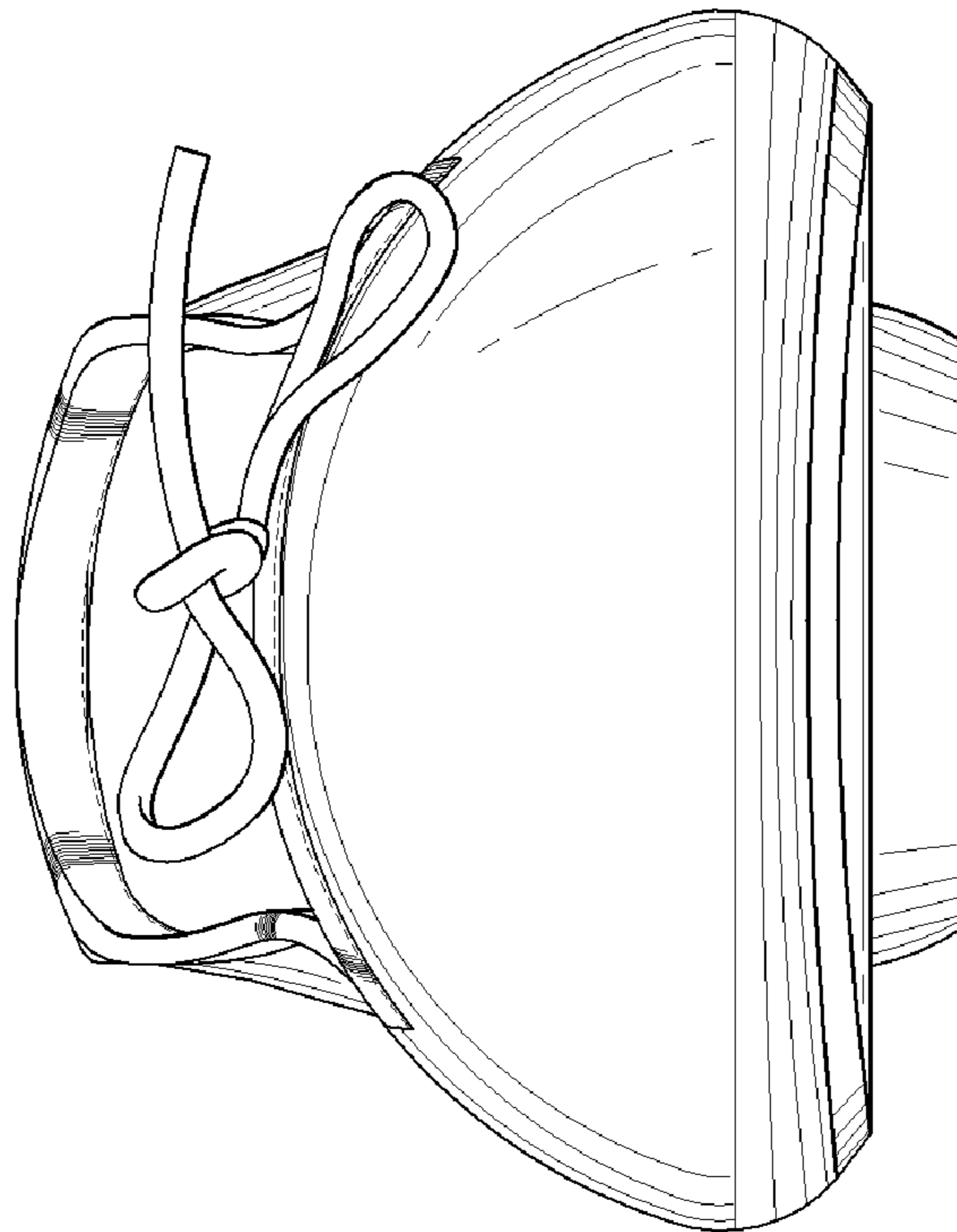
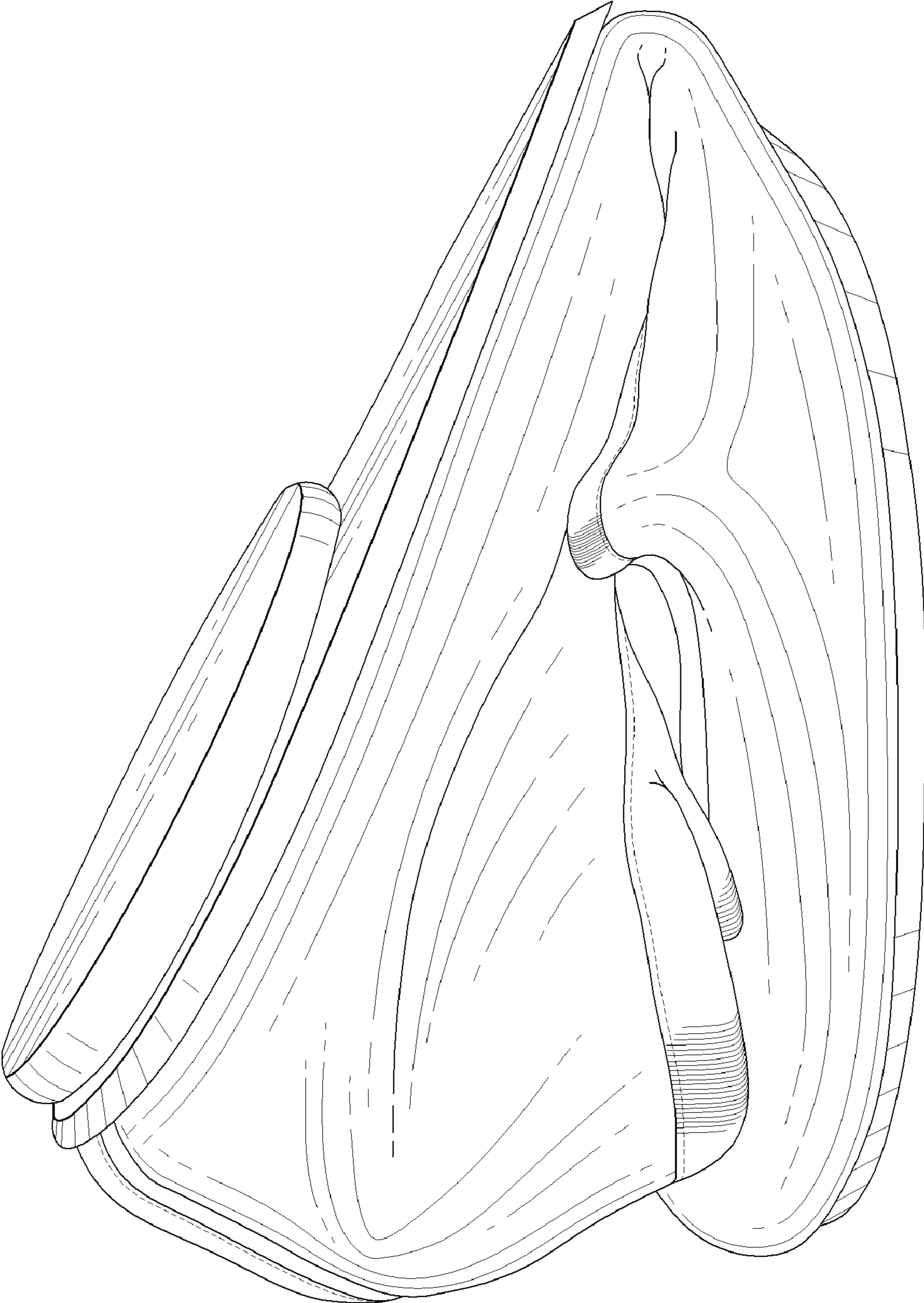

FIG. 8





UNITED STATES PATENT AND TRADEMARK OFFICE  
**CERTIFICATE OF CORRECTION**

PATENT NO. : D665,977 S  
APPLICATION NO. : 29/389666  
DATED : August 28, 2012  
INVENTOR(S) : Christine Natkin

Page 1 of 1

It is certified that error appears in the above-identified patent and that said Letters Patent is hereby corrected as shown below:

On the Title Page

(74) Attorney, Agent,  
or Firm

Delete "Hales"  
Insert -- Hale --

Signed and Sealed this  
Thirtieth Day of April, 2013



Teresa Stanek Rea  
*Acting Director of the United States Patent and Trademark Office*