



US00D665922S

(12) **United States Design Patent**
Yoder

(10) **Patent No.:** **US D665,922 S**

(45) **Date of Patent:** **** Aug. 21, 2012**

(54) **DOUBLE CAPTURE FRAME MEMBER FOR
A MODULAR BUILDING WITHOUT
ENGAGING CLIPS**

(75) Inventor: **Steven M. Yoder**, Shawnee, KS (US)

(73) Assignee: **Performance Contracting, Inc.**,
Lenexa, KS (US)

(**) Term: **14 Years**

(21) Appl. No.: **29/388,518**

(22) Filed: **Mar. 30, 2011**

(51) **LOC (9) Cl.** **25-02**

(52) **U.S. Cl.** **D25/61**

(58) **Field of Classification Search** 52/283,
52/634, 639, 643, 690, 96, 94; D25/199,
D25/164, 61

See application file for complete search history.

(56) **References Cited**

U.S. PATENT DOCUMENTS

1,532,695	A *	4/1925	Harting et al.	52/262
1,552,474	A *	9/1925	Dornier	52/634
2,177,699	A *	10/1939	Fisher	52/236.3
2,414,094	A *	1/1947	Couelle	52/690
2,858,916	A *	11/1958	Josephs	52/377
3,127,960	A *	4/1964	Smith et al.	52/222
3,135,070	A *	6/1964	Waring et al.	52/94
3,141,531	A *	7/1964	Montgomery	52/634
3,735,540	A *	5/1973	Thaler	52/94
3,783,564	A *	1/1974	Dunn et al.	52/96
3,834,104	A *	9/1974	Dunn et al.	52/376
3,849,961	A *	11/1974	Gwynne	52/639
3,984,951	A *	10/1976	Hindman	52/91.3
5,425,207	A *	6/1995	Shayman	52/79.9
6,088,971	A *	7/2000	Nystrom	52/95
6,092,340	A *	7/2000	Simmons	52/92.1

6,195,950	B1 *	3/2001	Harris	52/270
D472,648	S *	4/2003	Linsley	D25/61
6,604,328	B1 *	8/2003	Paddock	52/93.1
6,751,911	B1 *	6/2004	Gates et al.	52/96
6,786,018	B2 *	9/2004	Webb et al.	52/300
6,820,376	B2 *	11/2004	Morphet	52/58
7,228,670	B2 *	6/2007	Ollman	52/633
2003/0009963	A1 *	1/2003	Crowell	52/270
2004/0134162	A1	7/2004	Douglas	
2005/0011142	A1 *	1/2005	Higgins	52/90.1
2009/0272063	A1 *	11/2009	Siu	52/650.3

* cited by examiner

Primary Examiner — Doris Clark

(74) *Attorney, Agent, or Firm* — Womble Carlyle Sandridge & Rice LLP

(57) **CLAIM**

The ornamental design for a double capture frame member for a modular building without engaging clips, as shown and described.

DESCRIPTION

FIG. 1 is a perspective view of a double capture frame member for a modular building without engaging clips showing my new design.

FIG. 2 is a second perspective view of the frame member of FIG. 1.

FIG. 3 is a front view of the frame member of FIG. 1.

FIG. 4 is a rear view of the frame member of FIG. 1.

FIG. 5 is a right side view of the frame member of FIG. 1.

FIG. 6 is a left side view of the frame member of FIG. 1.

FIG. 7 is a top view of the frame member of FIG. 1; and,

FIG. 8 is a bottom view of the frame member of FIG. 1.

The broken lines shown herein are for illustrative purposes and form no part of the claimed design.

1 Claim, 5 Drawing Sheets

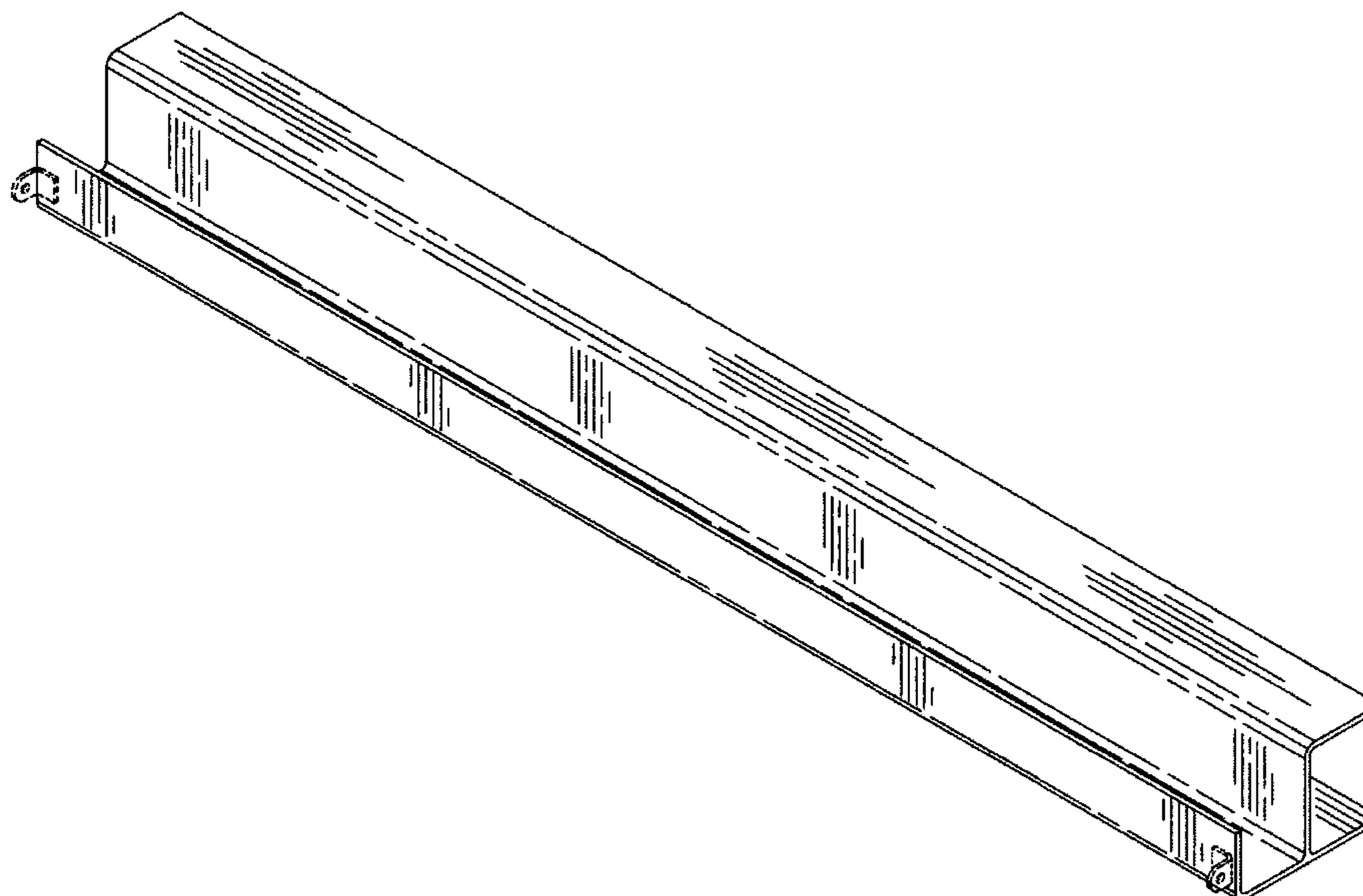

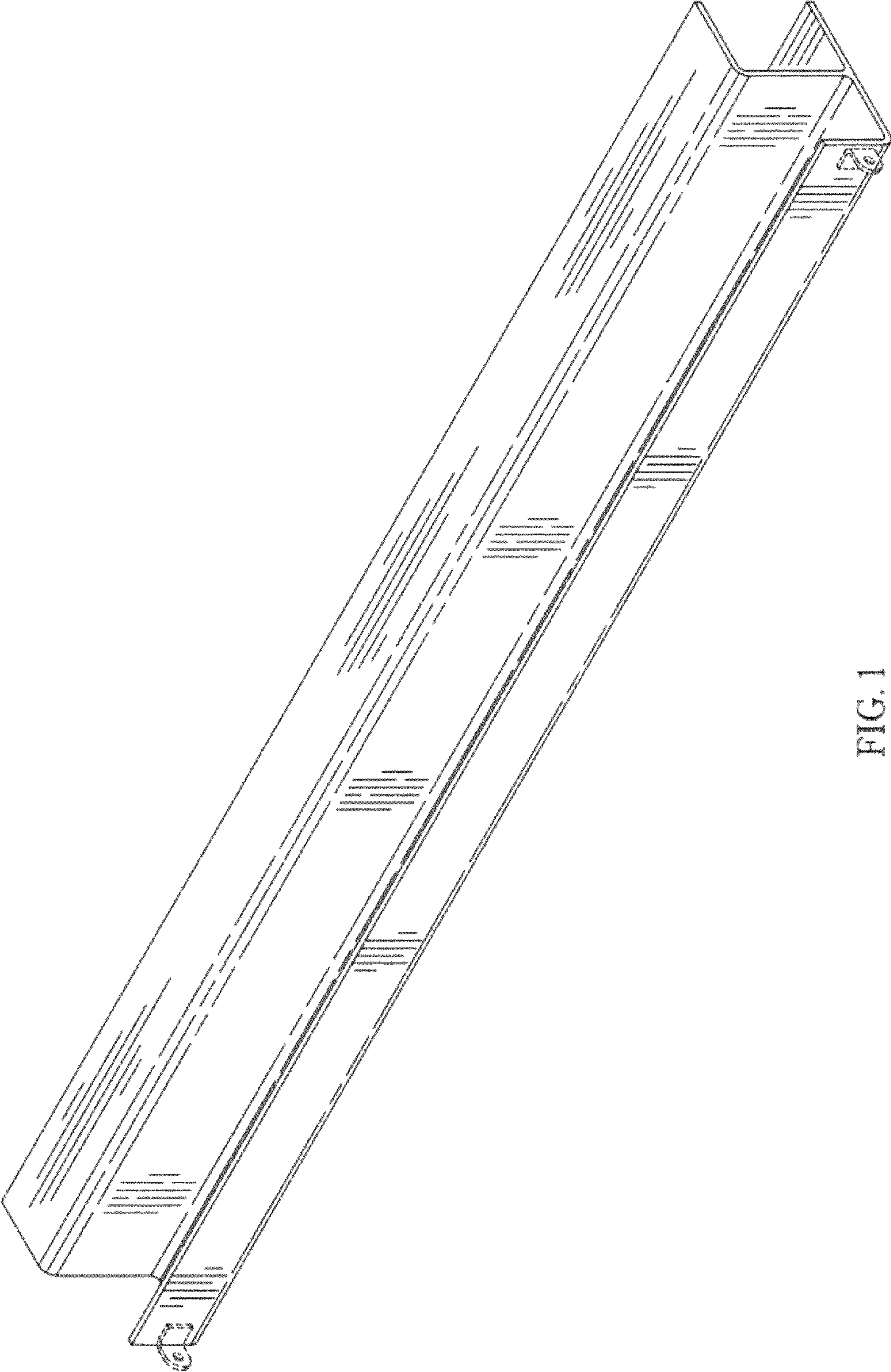

FIG. 1

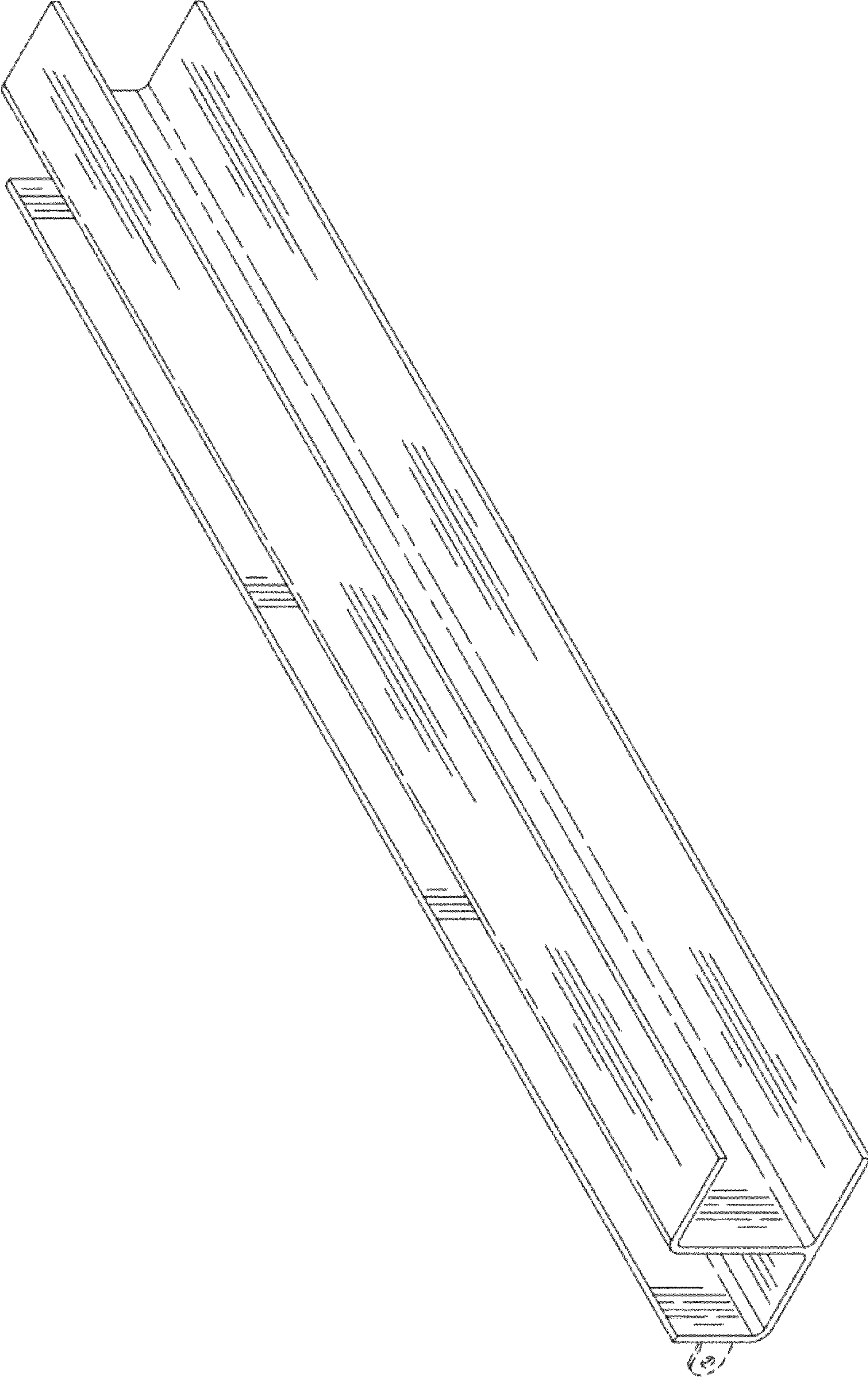

FIG. 2

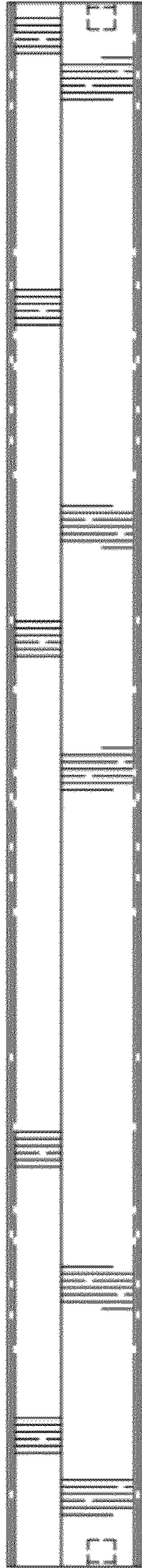

FIG. 3

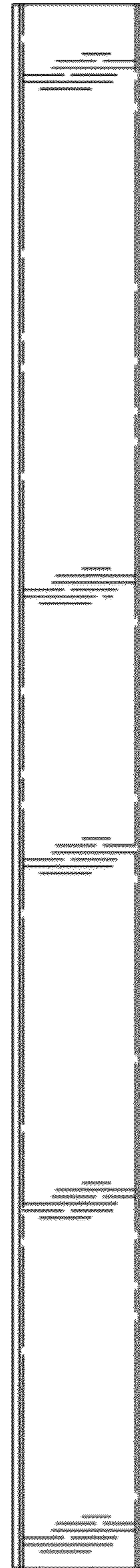

FIG. 4

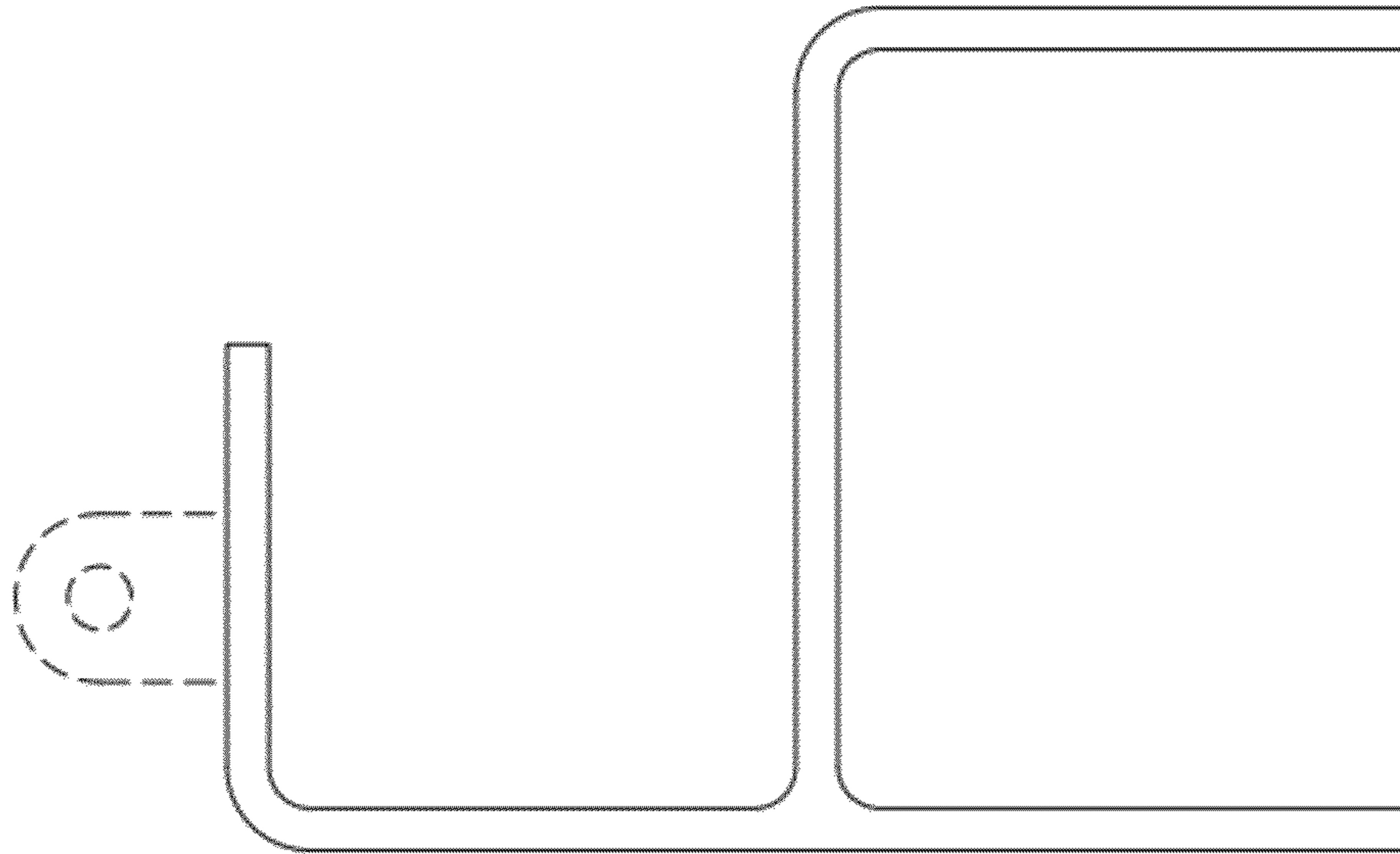

FIG. 5

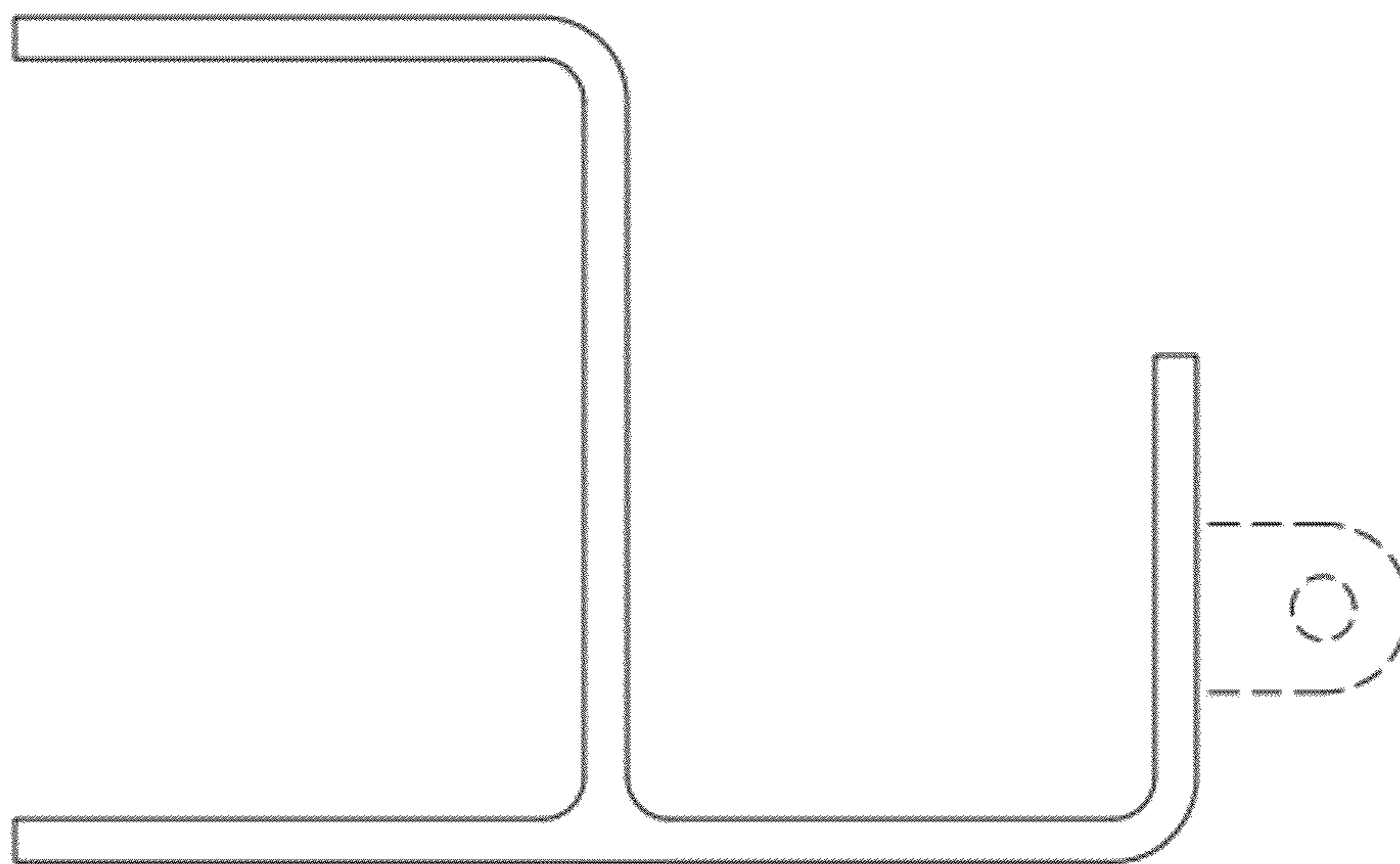

FIG. 6

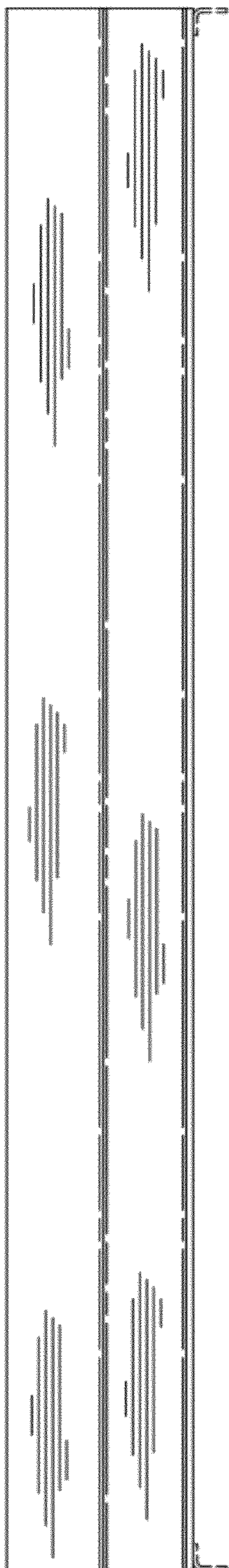

FIG. 7

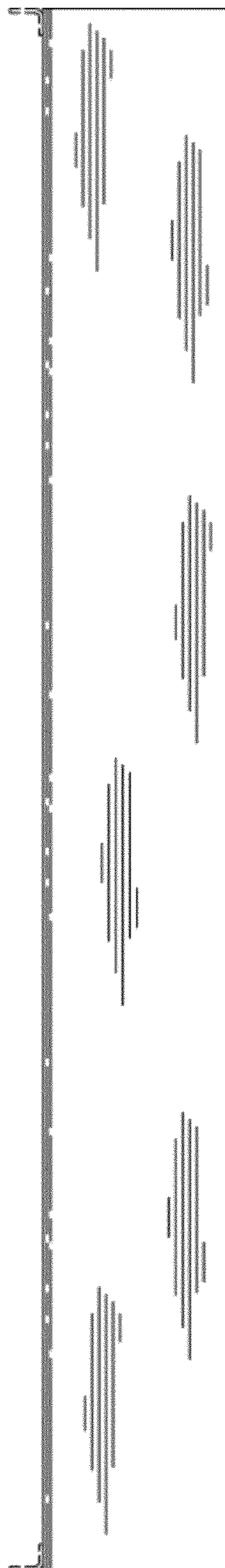

FIG. 8