

US00D665900S

(12) **United States Design Patent**  
**Yen et al.**

(10) **Patent No.:** **US D665,900 S**  
(45) **Date of Patent:** **\*\* Aug. 21, 2012**

(54) **CENTRIFUGAL FAN**

(75) Inventors: **Kevin Yen**, Nagano Prefecture (JP); **Jiro Watanabe**, Nagano Prefecture (JP); **Hiromitsu Kuribayashi**, Nagano Prefecture (JP); **Shigekazu Mitomo**, Nagano Prefecture (JP)

(73) Assignee: **Sanyo Denki Co., Ltd.**, Tokyo (JP)

(\*\*) Term: **14 Years**

(21) Appl. No.: **29/381,711**

(22) Filed: **Dec. 22, 2010**

(30) **Foreign Application Priority Data**

Jun. 25, 2010 (JP) ..... 2010-015648

(51) **LOC (9) Cl.** ..... **23-04**

(52) **U.S. Cl.** ..... **D23/411**

(58) **Field of Classification Search** ..... D6/309;  
D13/179; D23/370-386, 411-414; 165/80.3,  
165/120-122, 900; 310/12.13, 26, 52, 58,  
310/60 A, 60 R, 61-65, 112, 125, 156.35-156.37,  
310/157, 211, 261.1, 266, 268; 361/679.48,  
361/694-697; 392/365, 373, 382, 383; 415/60,  
415/66, 68, 175-178, 206, 208.1, 211.2,  
415/213.1, 214.1, 215.1; 416/179, 185, 186 R,  
416/187, 244 R, 246, 247 R

See application file for complete search history.

(56) **References Cited**

**U.S. PATENT DOCUMENTS**

D209,250 S \* 11/1967 Grad ..... D23/379  
D487,310 S \* 3/2004 Li et al. .... D23/411  
D507,637 S \* 7/2005 Chiu et al. .... D23/370  
D637,276 S \* 5/2011 Miyabara et al. .... D23/370  
2012/0087813 A1 \* 4/2012 Yen et al. .... 417/410.1

**FOREIGN PATENT DOCUMENTS**

JP H07-14192 3/1995

\* cited by examiner

*Primary Examiner* — Garth Rademaker

(74) *Attorney, Agent, or Firm* — Rankin, Hill & Clark LLP

(57) **CLAIM**

We claim the ornamental design for a centrifugal fan, as shown and described.

**DESCRIPTION**

FIG. 1 is a front elevation view of a centrifugal fan embodying our design, shown in an environment of use; FIG. 2 is a rear elevation view thereof; FIG. 3 is a right side elevation view thereof; FIG. 4 is a left side elevation view thereof; FIG. 5 is a top plan view thereof; FIG. 6 is a bottom plan view thereof; FIG. 7 is a cross-sectional view thereof, taken along line 7-7 of FIG. 4; FIG. 8 is a cross-sectional view thereof, taken along line 8-8 of FIG. 4; FIG. 9 is a cross-sectional view thereof, taken along line 9-9 of FIG. 4; FIG. 10 is a perspective view thereof; FIG. 11 is a front elevation view thereof, shown at an enlarged scale and with the environment removed; FIG. 12 is a rear elevation view thereof; FIG. 13 is a right side elevation view thereof; FIG. 14 is a left side elevation view thereof; FIG. 15 is a top plan view thereof; and, FIG. 16 is a bottom plan view thereof.

The evenly-spaced broken lines depict environmental subject matter only and form no part of the claimed design. The unevenly-spaced broken lines show the boundaries of the claimed design only and form no part of the claimed design.

**1 Claim, 16 Drawing Sheets**

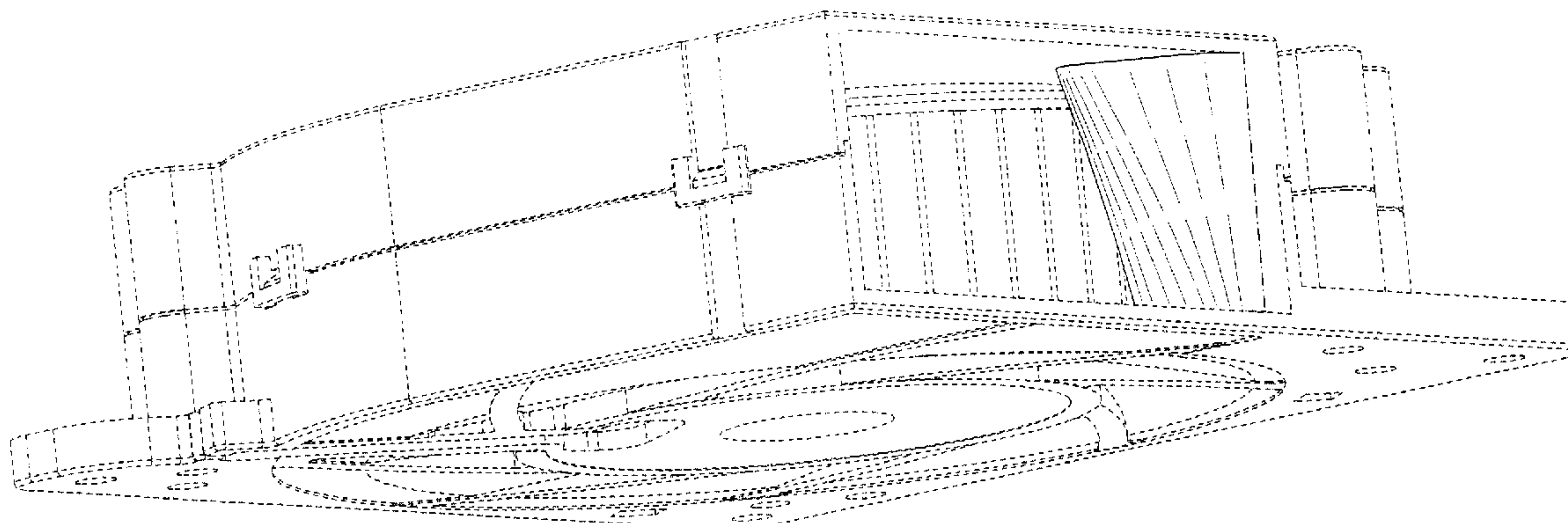

FIG. 1

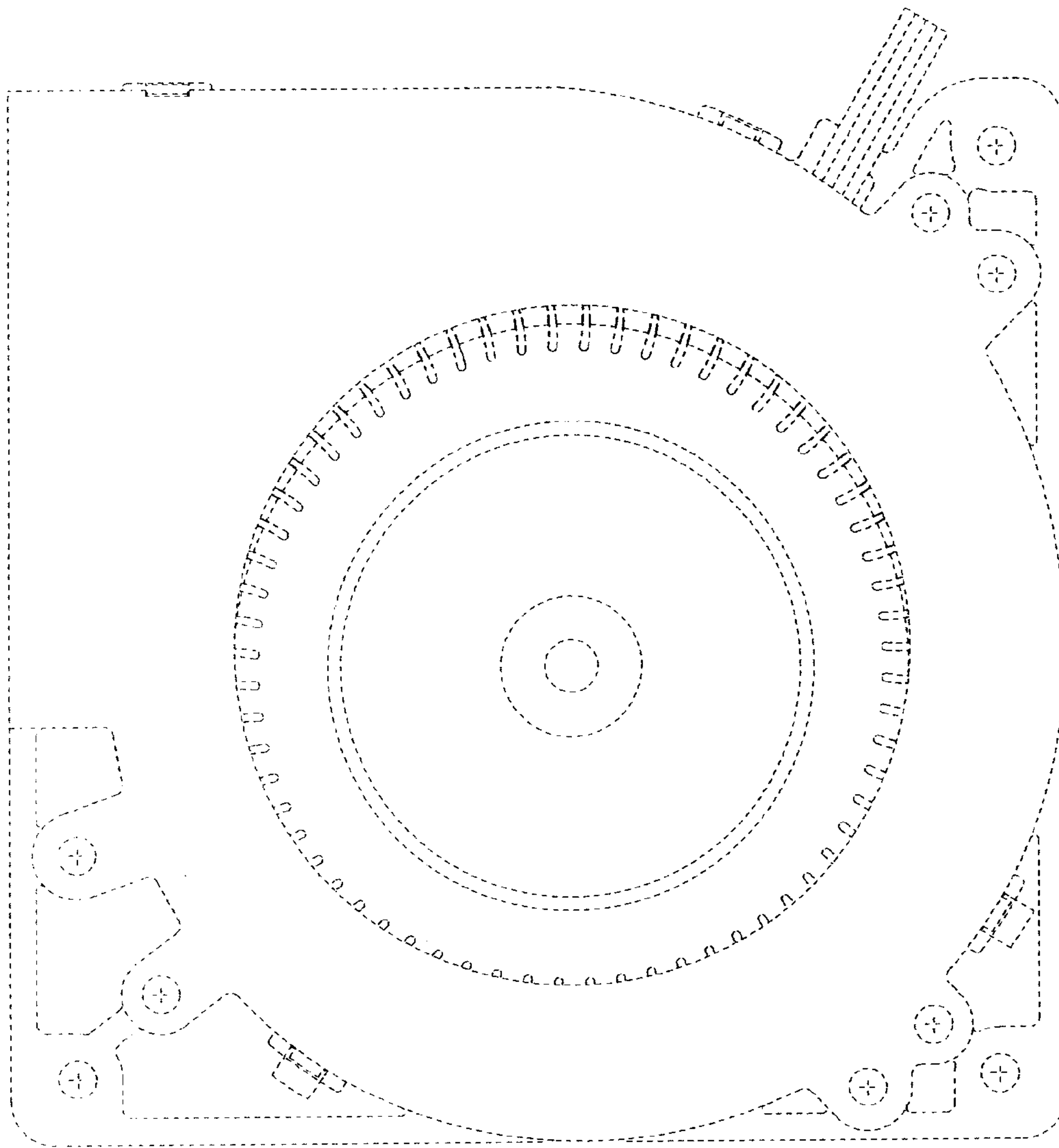

FIG.2

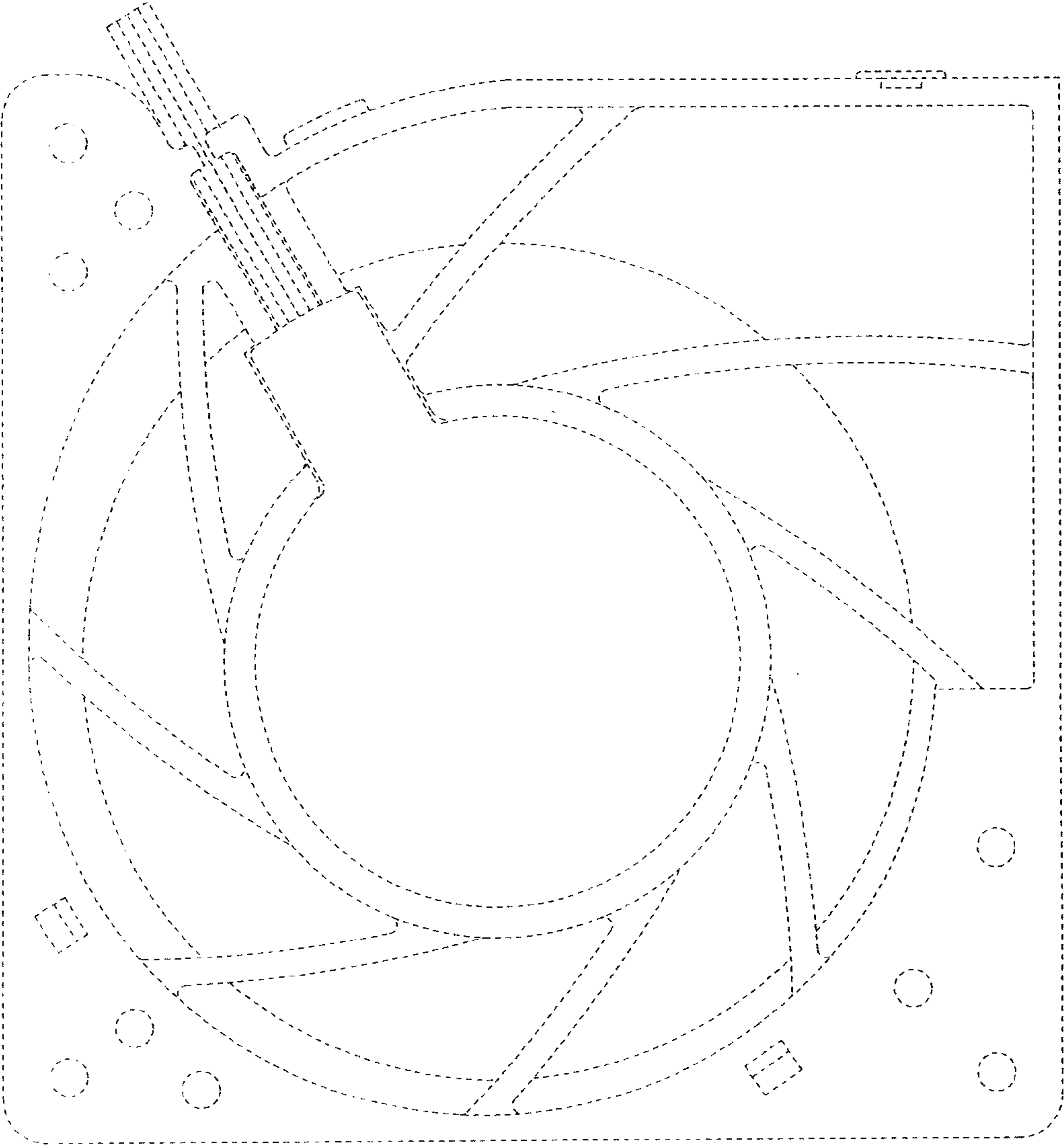

FIG.3

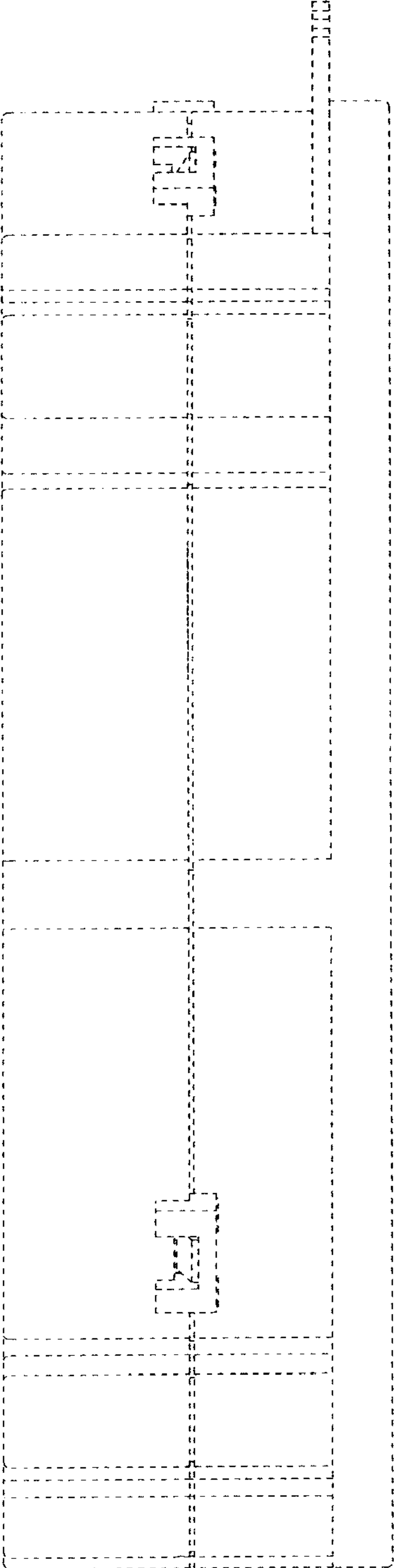

FIG. 4

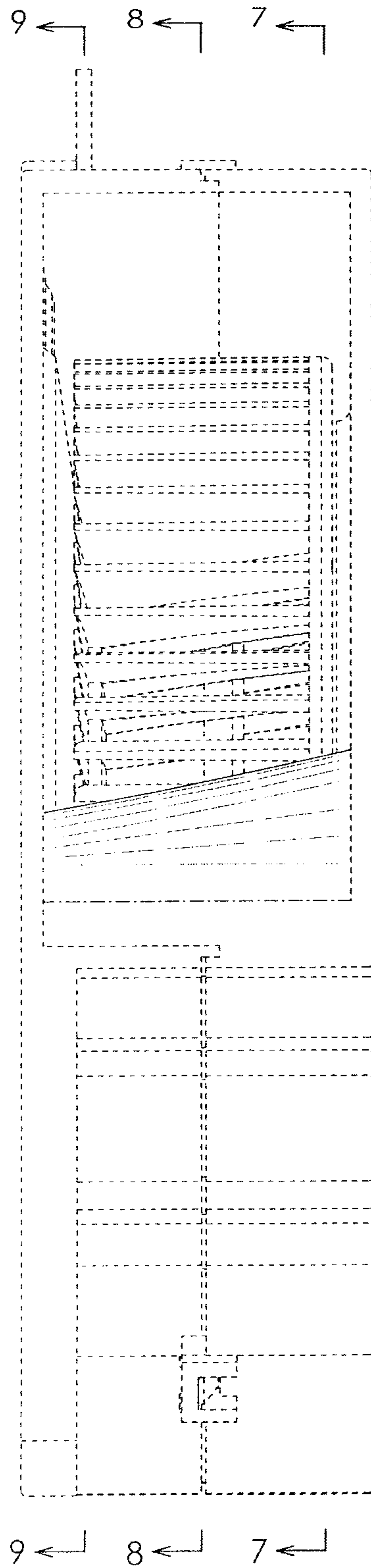

FIG. 5

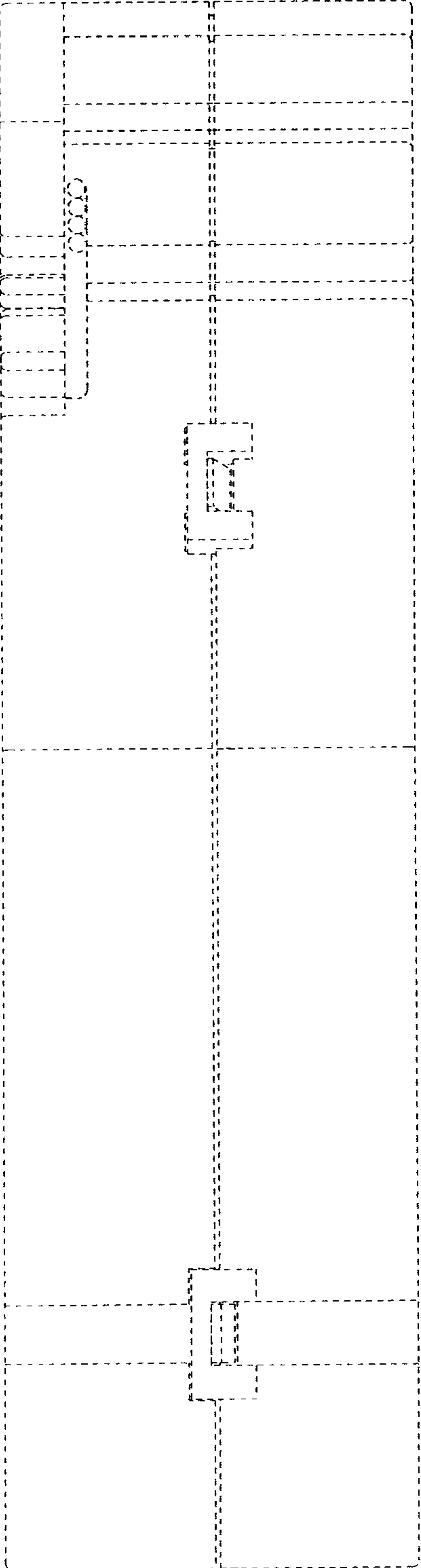



FIG. 6

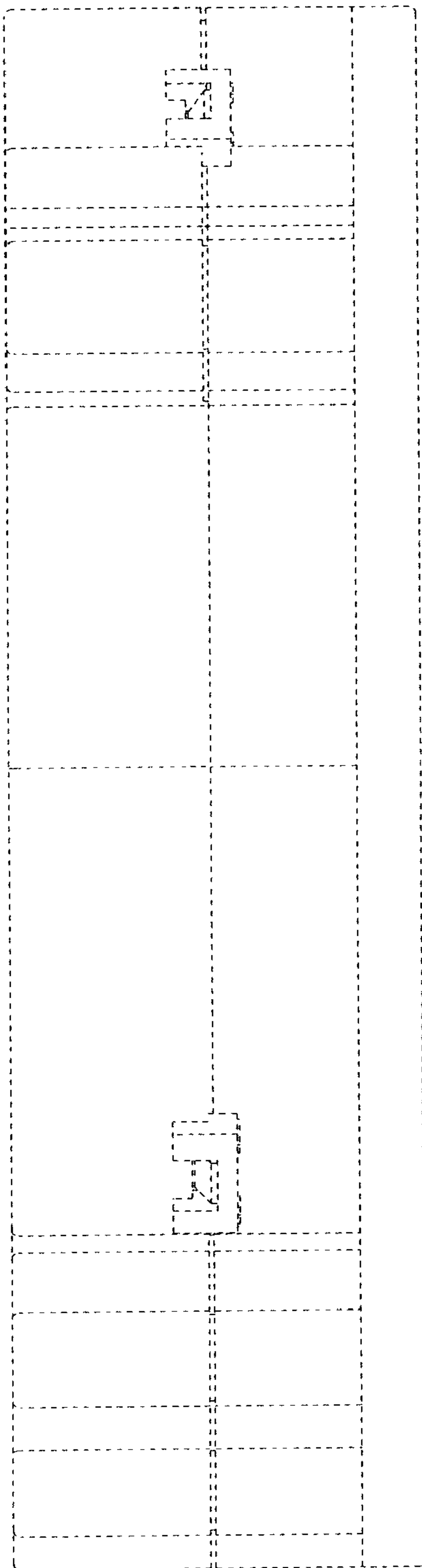

FIG.7

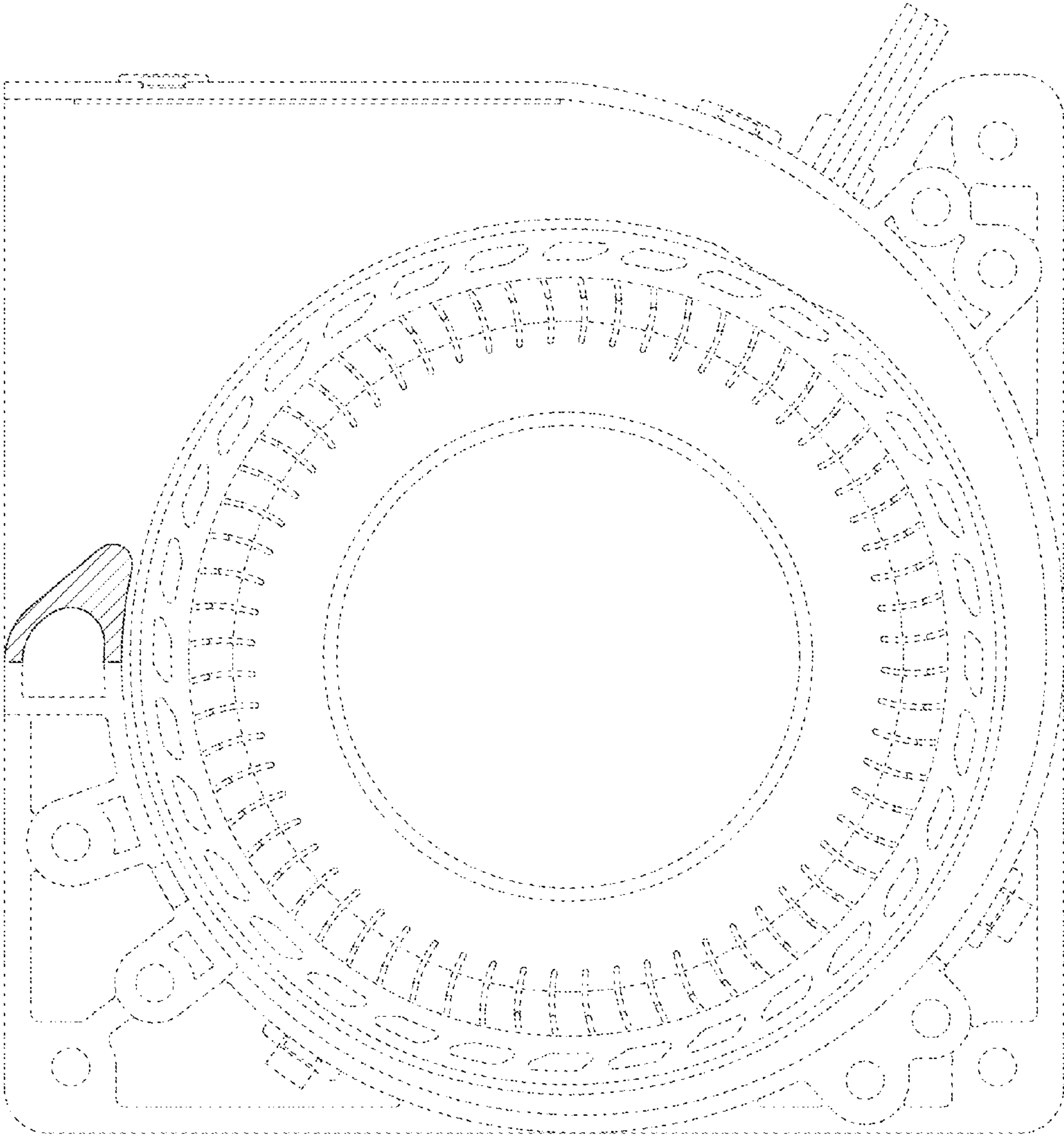



FIG.8

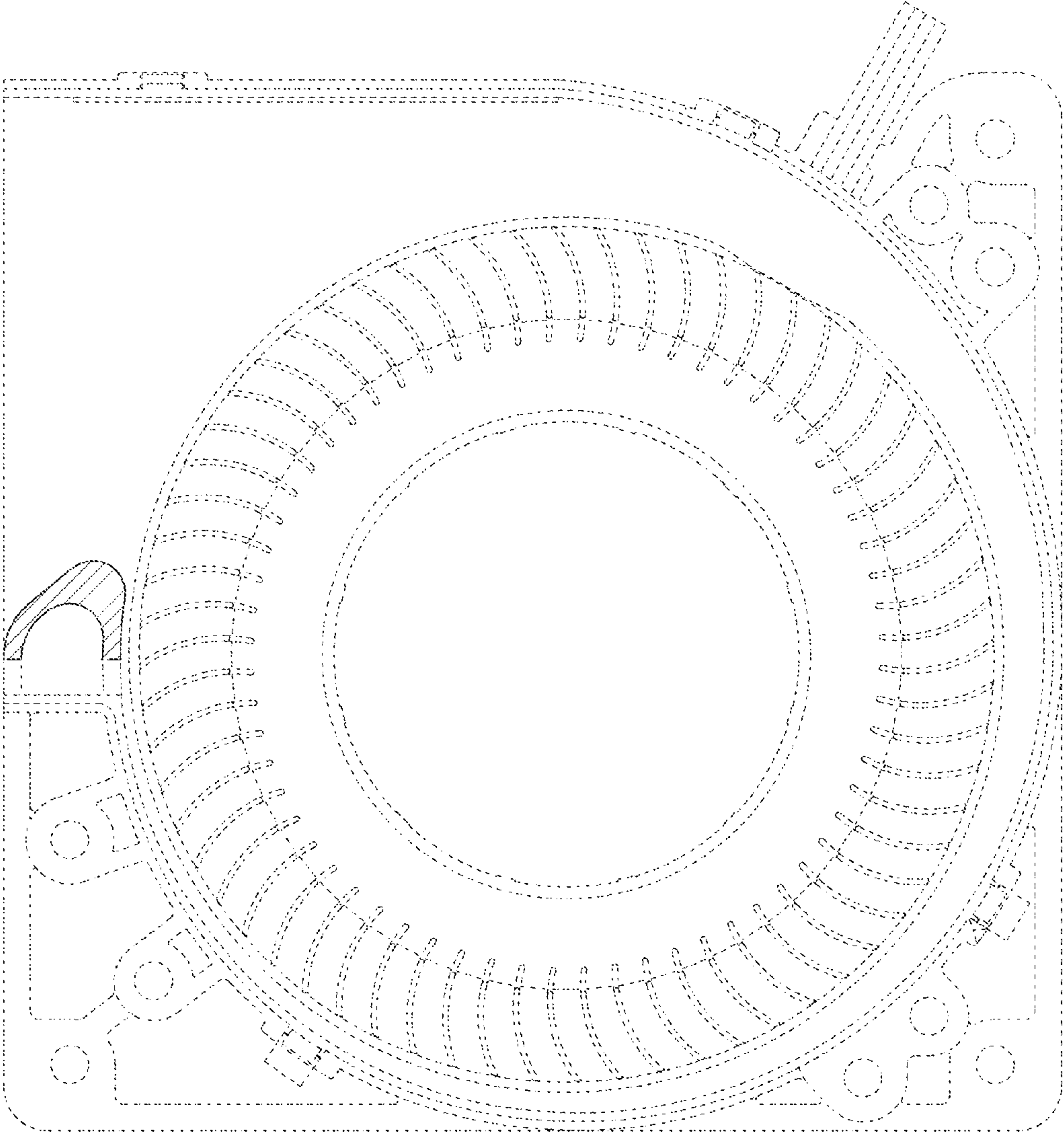

FIG.9

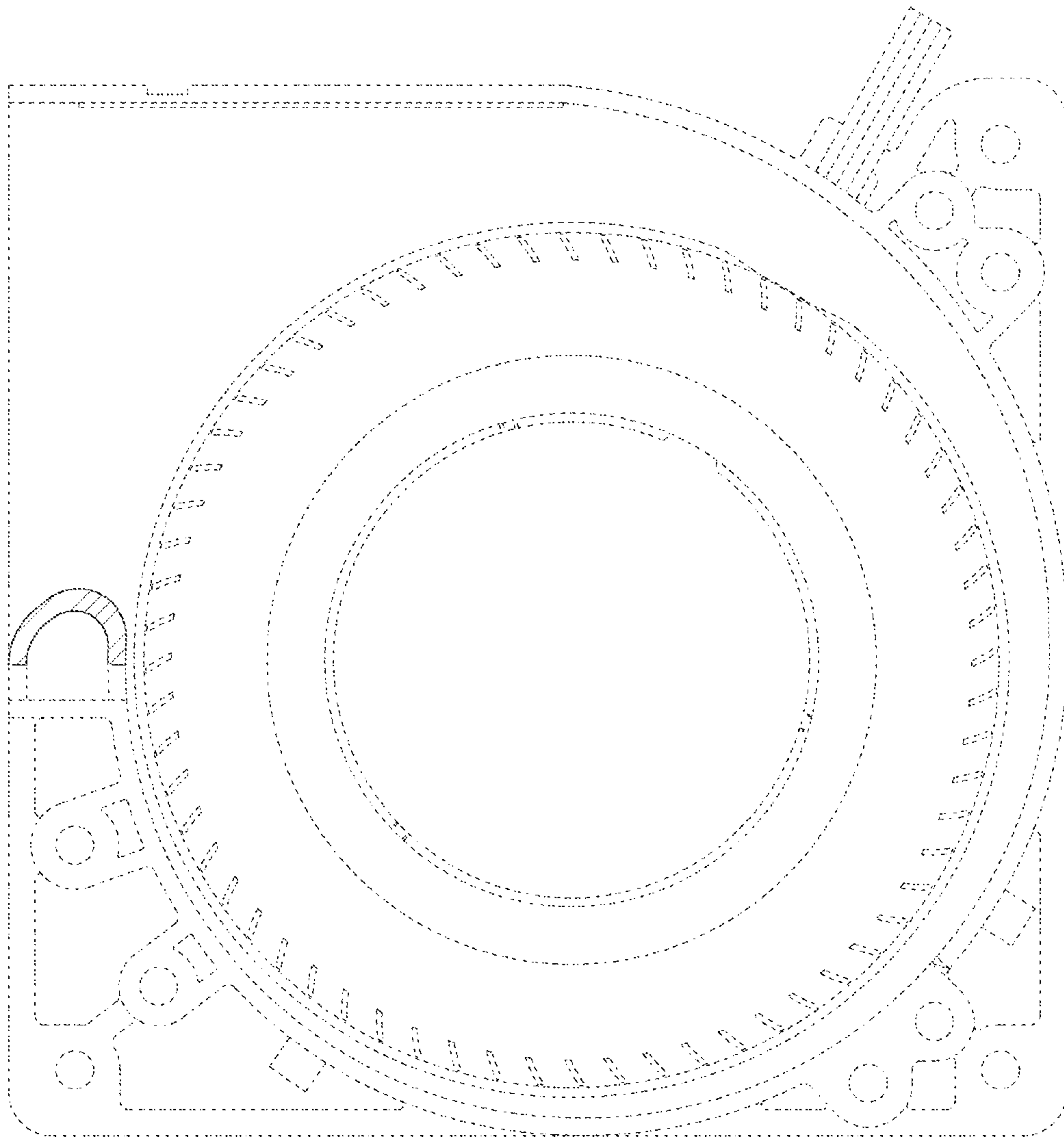

FIG. 10

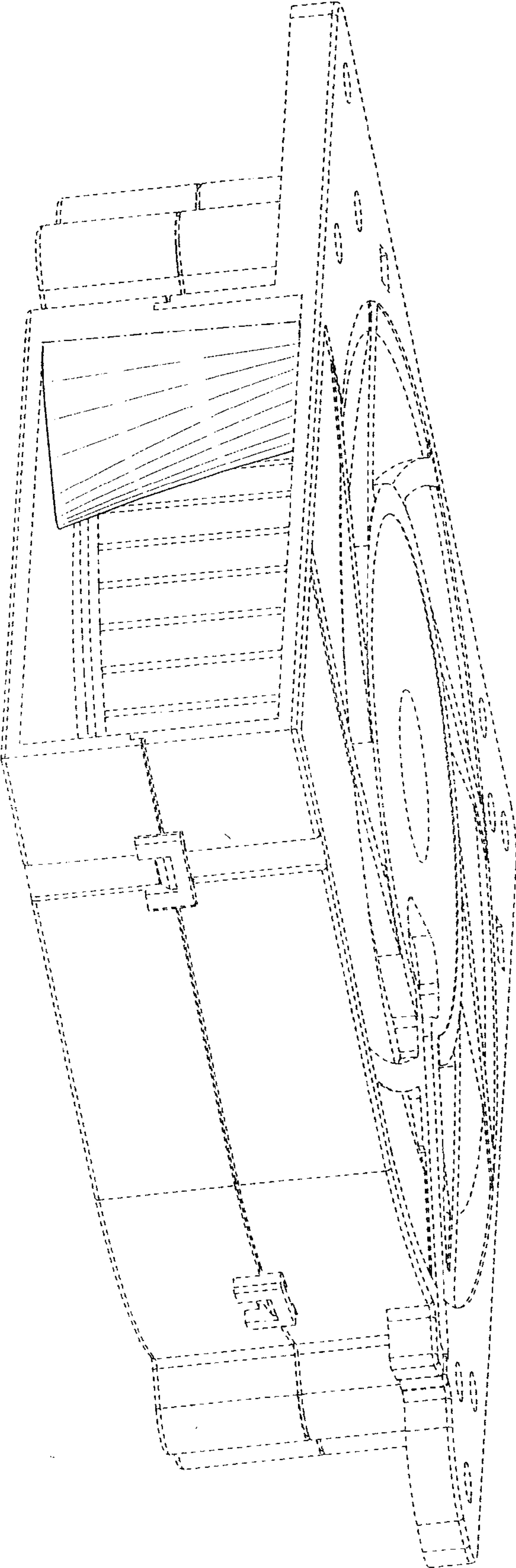

FIG. 11

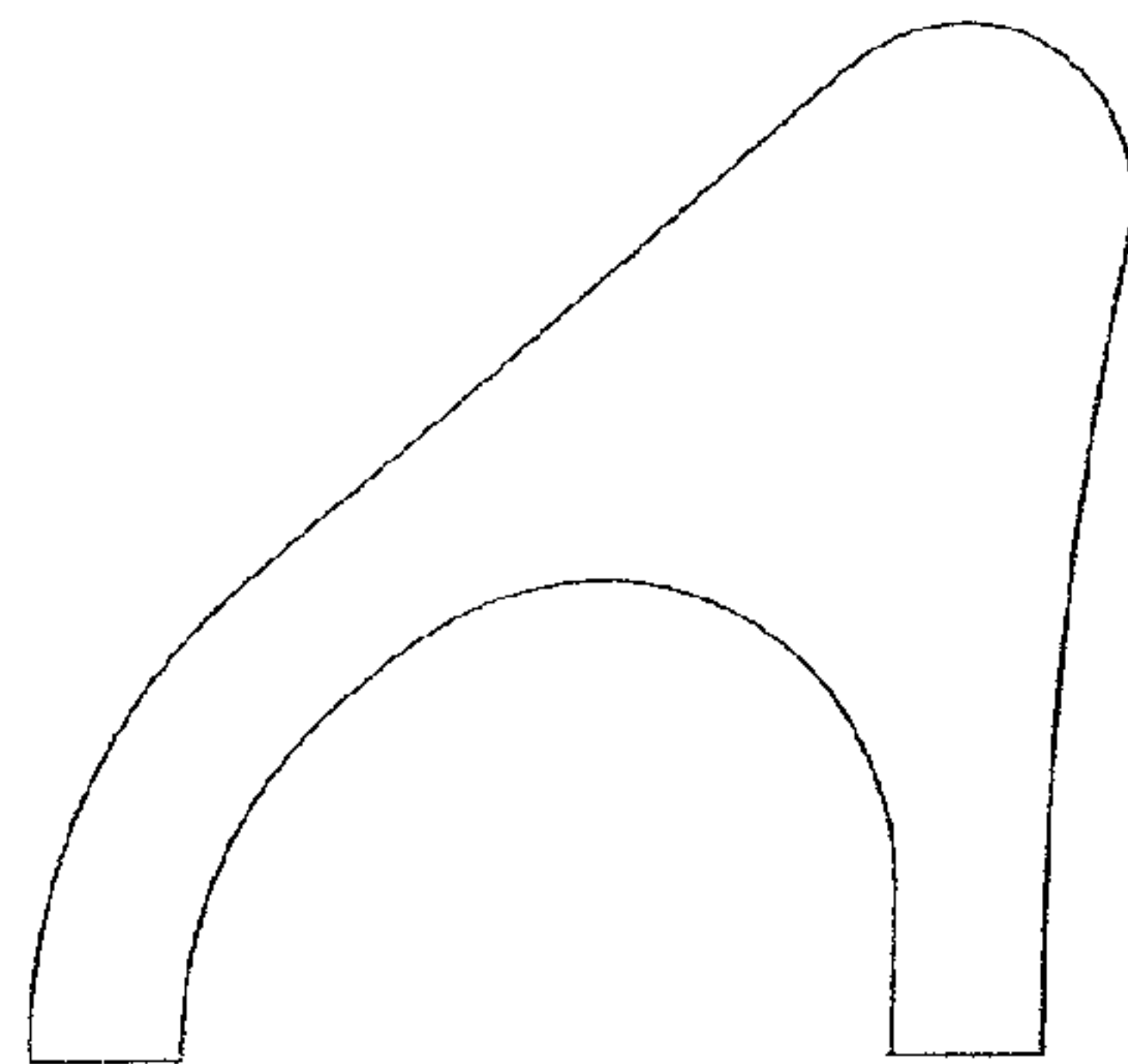

FIG.12

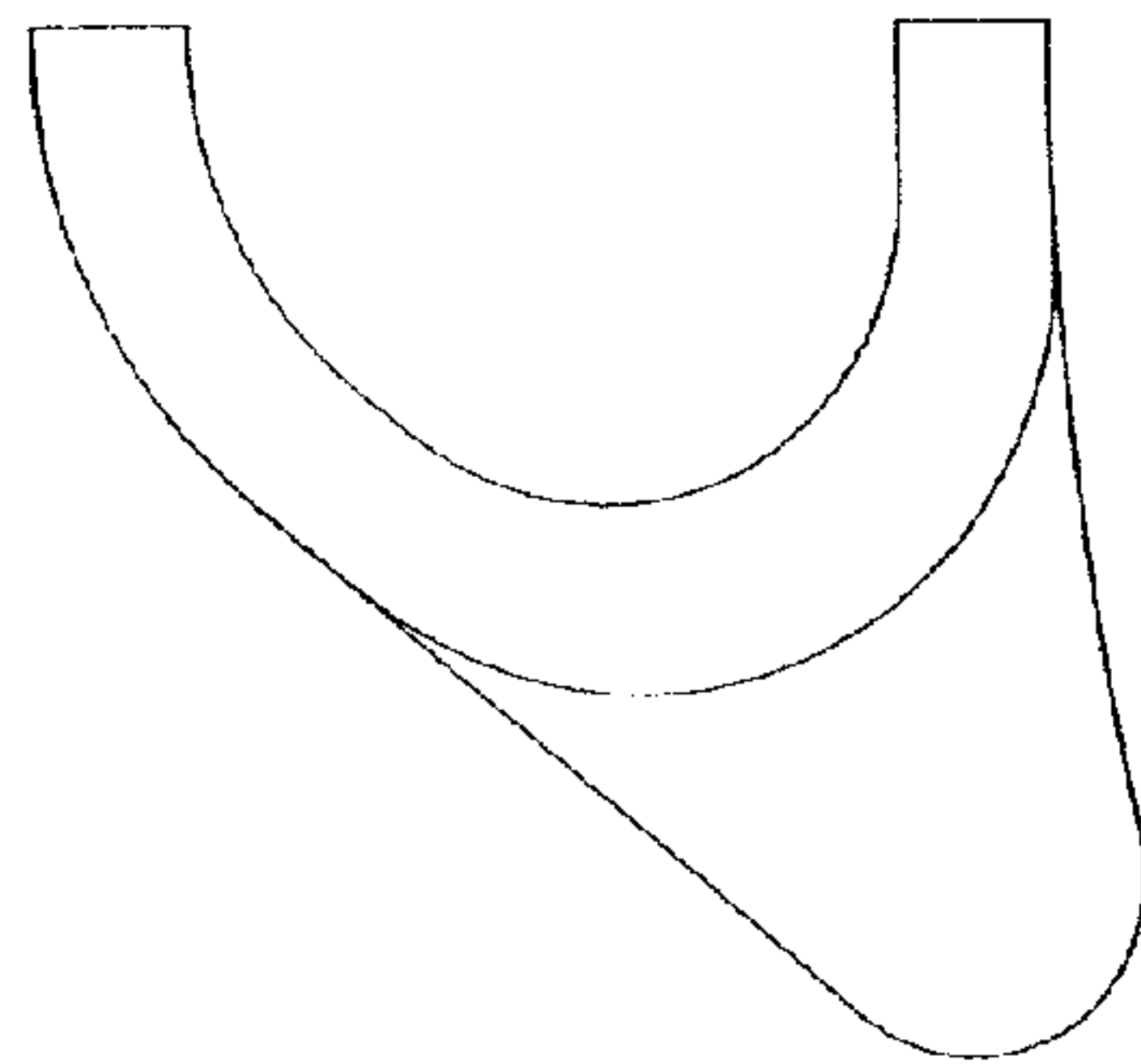

FIG.13

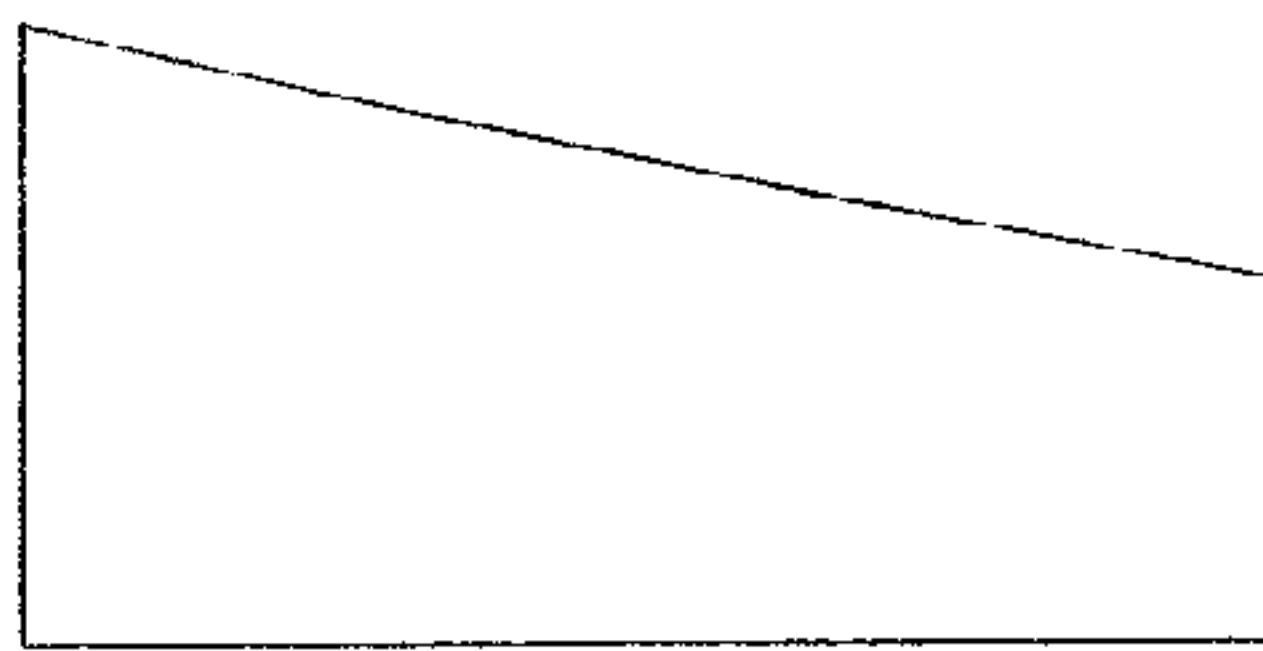



FIG. 14

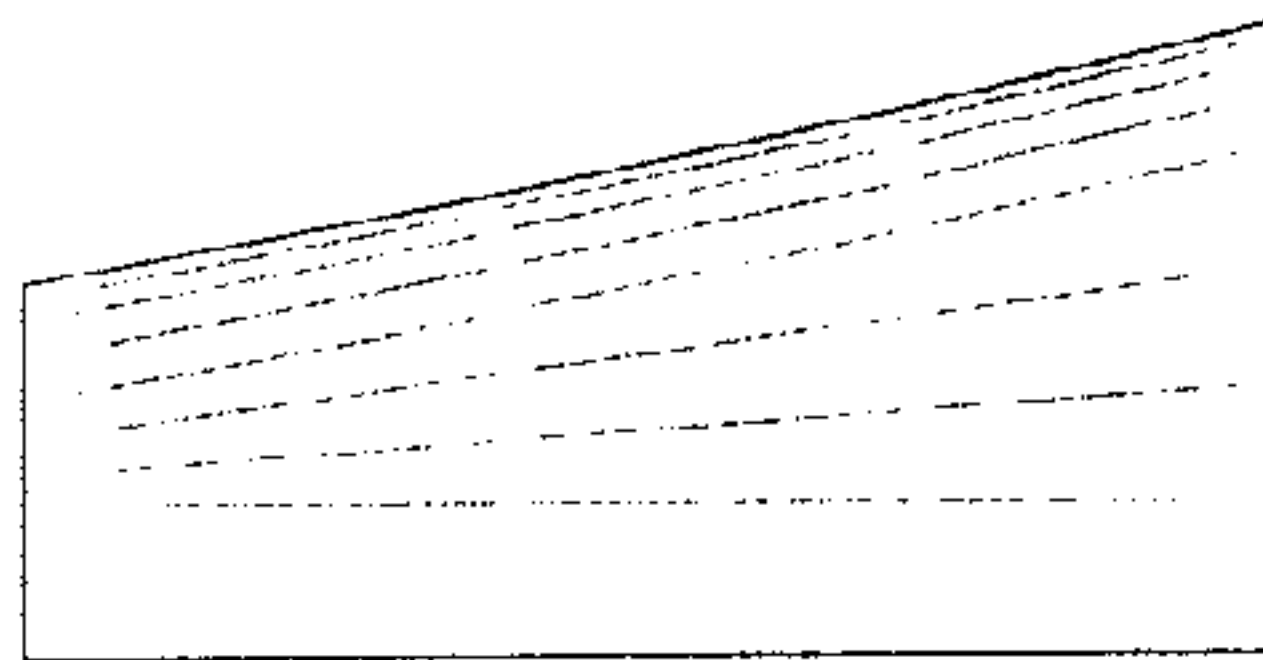

FIG.15

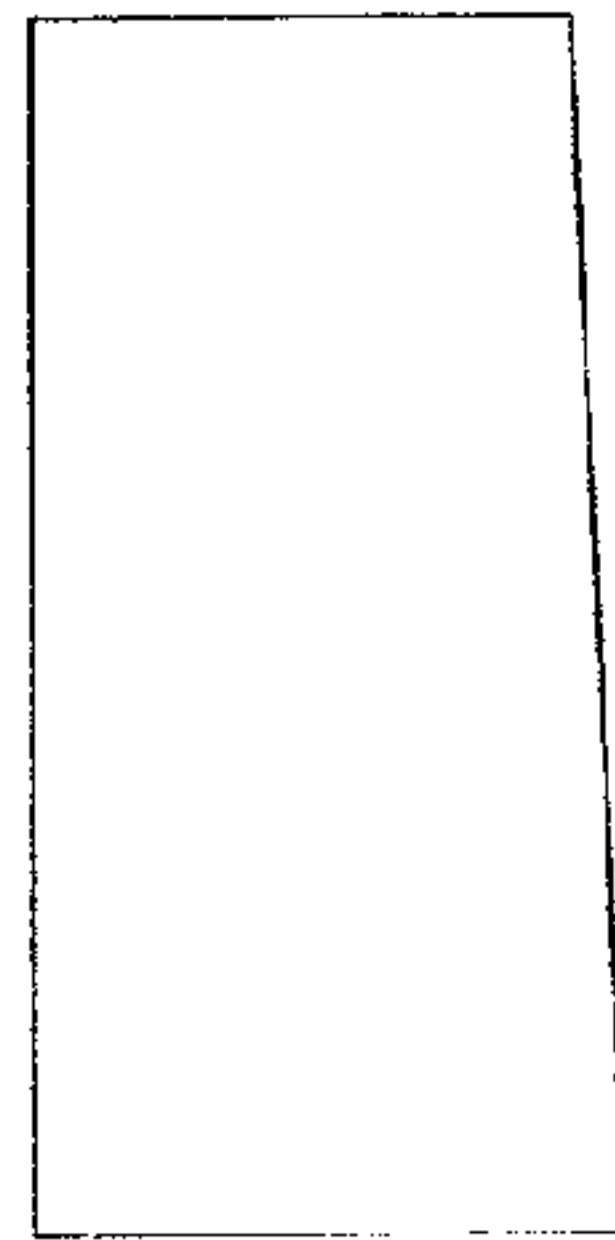

FIG. 16

