



US00D665876S

(12) **United States Design Patent**
Corbett

(10) **Patent No.:** **US D665,876 S**

(45) **Date of Patent:** **** Aug. 21, 2012**

(54) **FAUCET**

(75) Inventor: **Jessina Corbett**, Chicago, IL (US)

(73) Assignee: **Masco Corporation of Indiana**,
Indianapolis, IN (US)

(**) Term: **14 Years**

(21) Appl. No.: **29/406,713**

(22) Filed: **Nov. 18, 2011**

(51) **LOC (9) Cl.** **23-01**

(52) **U.S. Cl.** **D23/238**

(58) **Field of Classification Search** D23/238,
D23/241-243, 250, 252, 255, 257; 4/675-678;
137/801

See application file for complete search history.

(56) **References Cited**

U.S. PATENT DOCUMENTS

D441,837 S * 5/2001 Fabian et al. D23/238
D513,788 S * 1/2006 Lindholm D23/238

D532,868 S * 11/2006 Spangler et al. D23/238
D571,438 S * 6/2008 Gilbert D23/249
D642,661 S * 8/2011 Corbett D23/238
D653,732 S * 2/2012 Romero D23/238

* cited by examiner

Primary Examiner — Robert Delehanty

(74) *Attorney, Agent, or Firm* — Edgar A. Zarins; Nirav D. Parikh; Lora J. Graentzdoerffer

(57) **CLAIM**

The ornamental design for a faucet, as shown and described.

DESCRIPTION

FIG. 1 is a perspective view of a faucet showing my new design;

FIG. 2 is a right side view thereof;

FIG. 3 is a left side view thereof;

FIG. 4 is a front elevational view thereof;

FIG. 5 is a top plan view thereof;

FIG. 6 is a rear view thereof; and,

FIG. 7 is a bottom view thereof.

1 Claim, 3 Drawing Sheets

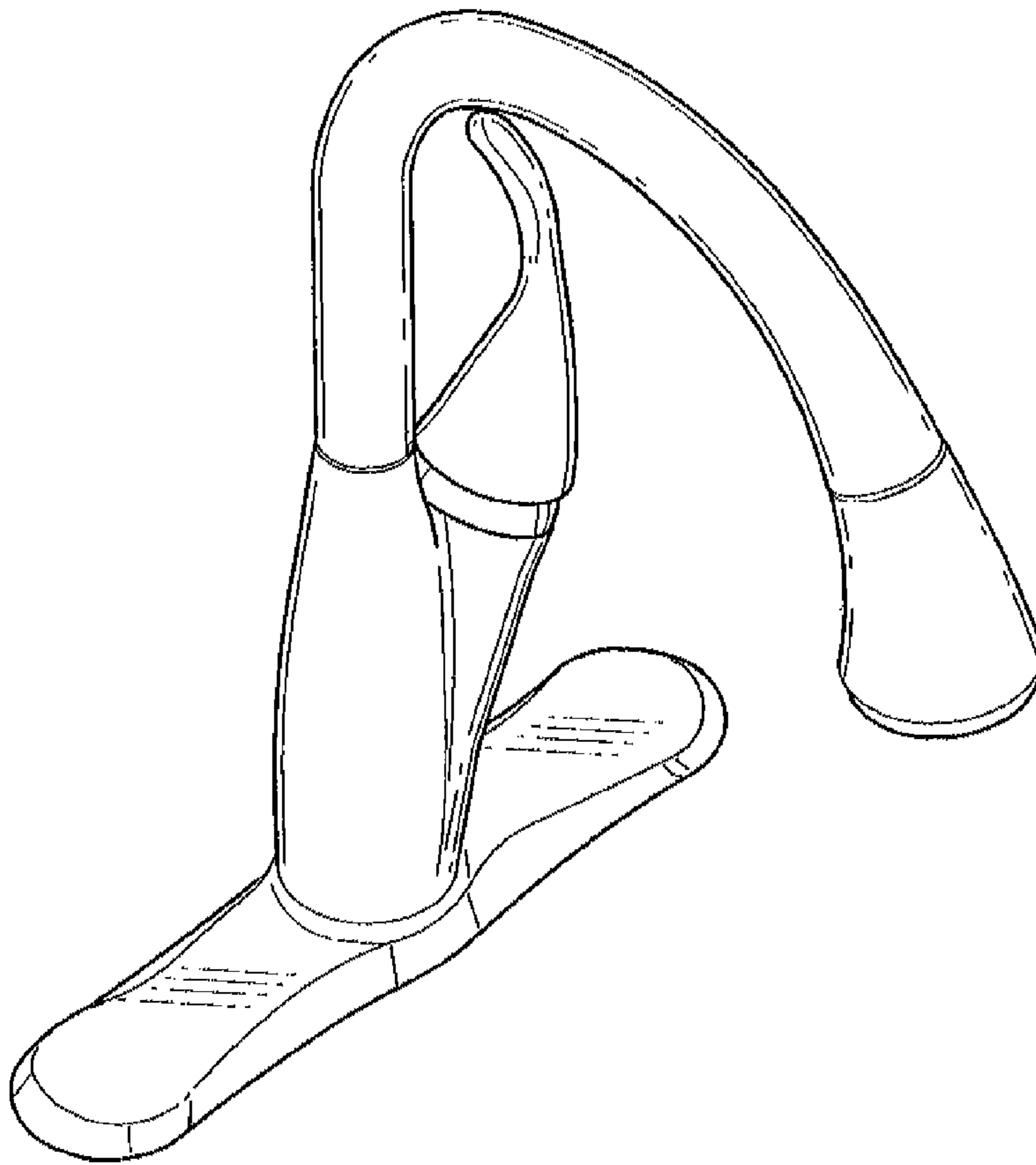

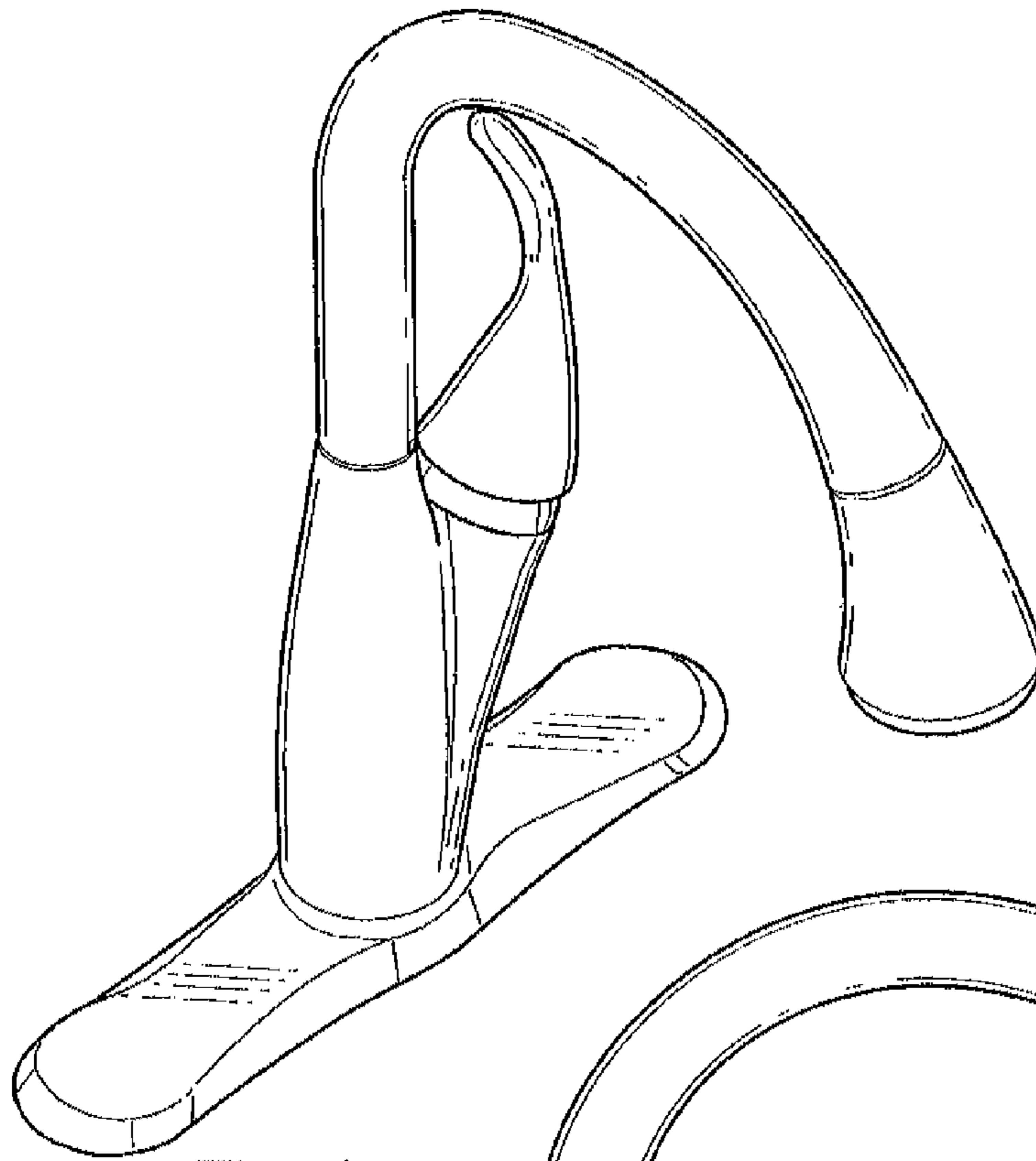

Fig-1

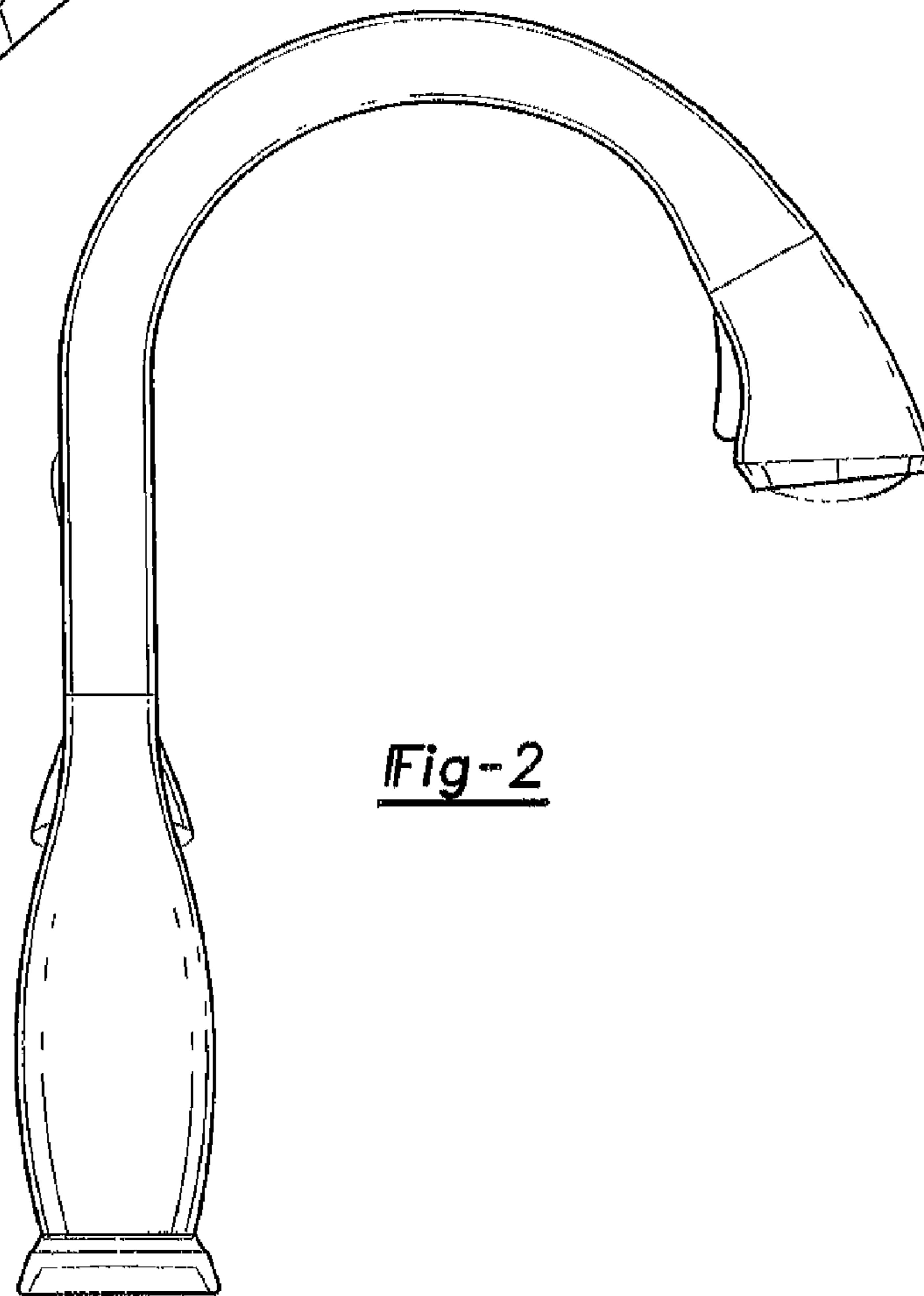

Fig-2

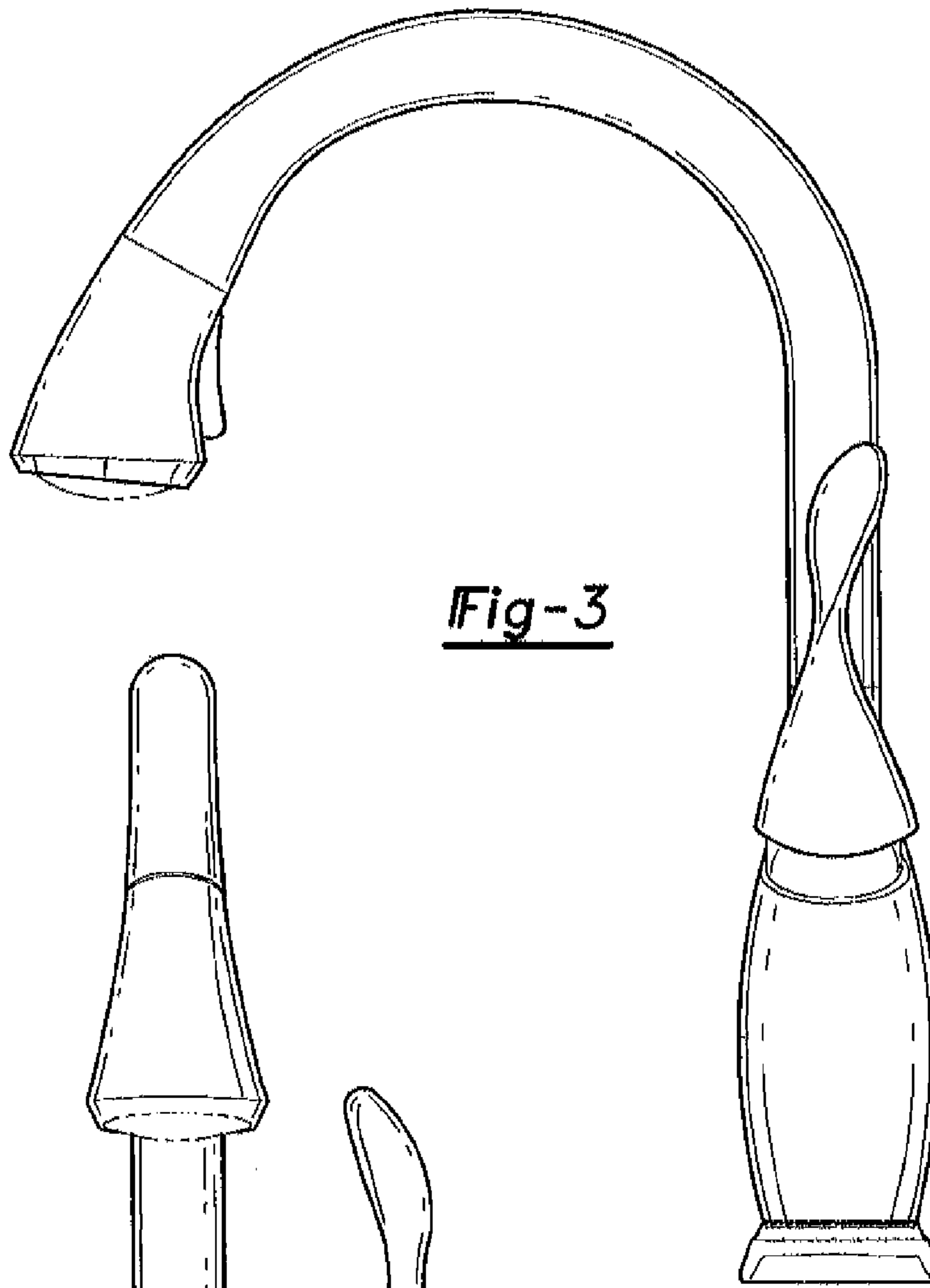

Fig-3

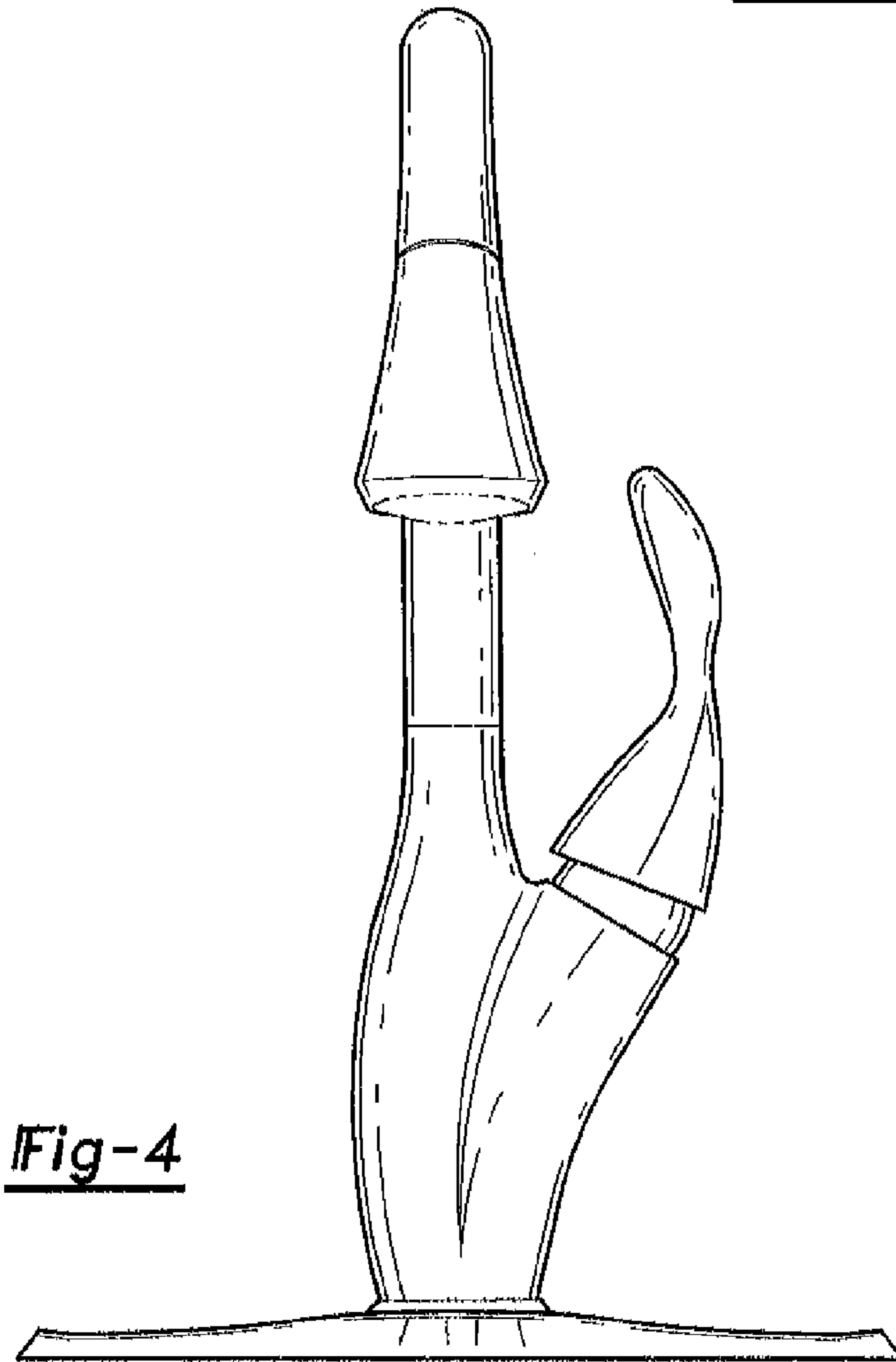

Fig-4

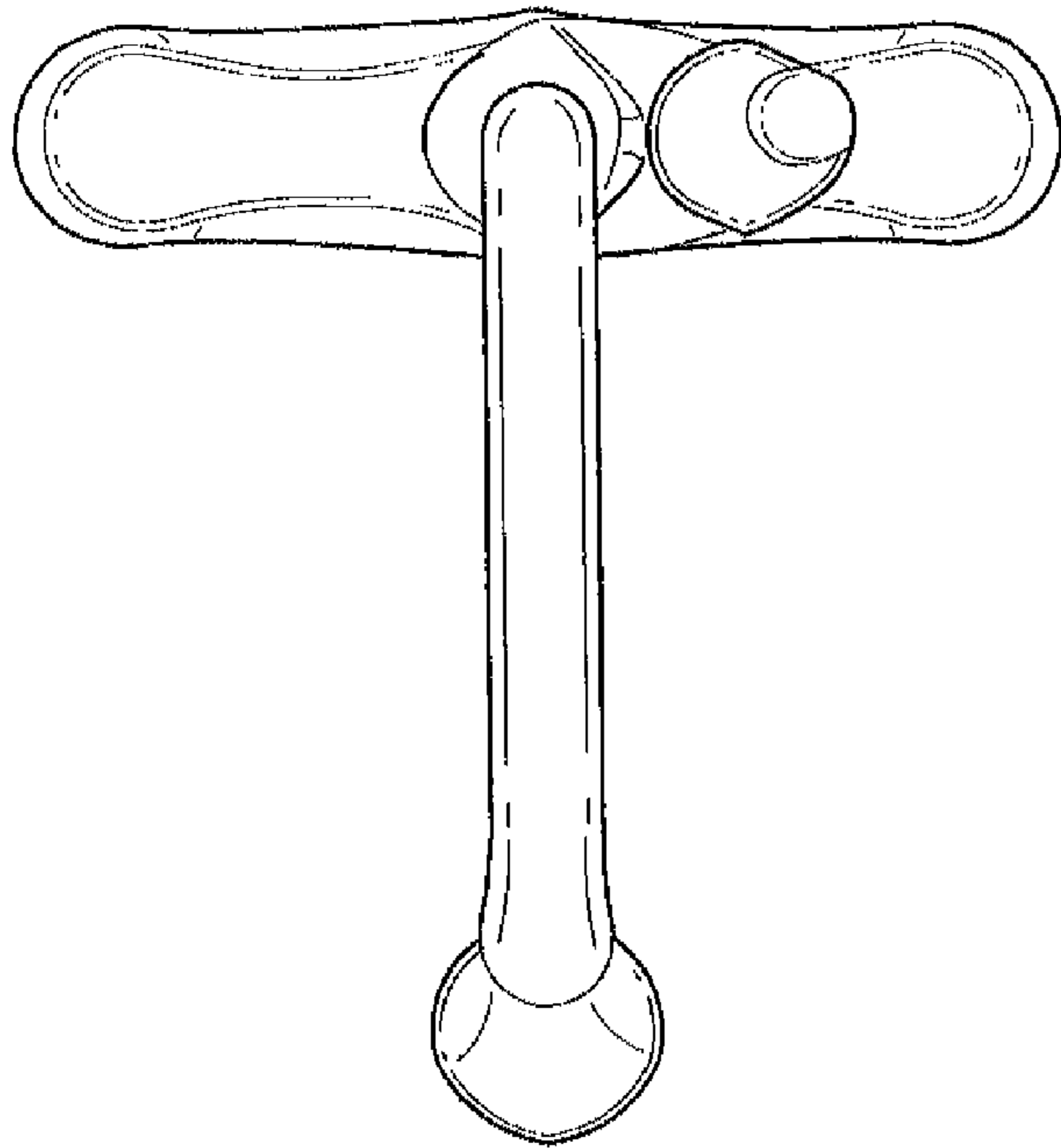

Fig-5

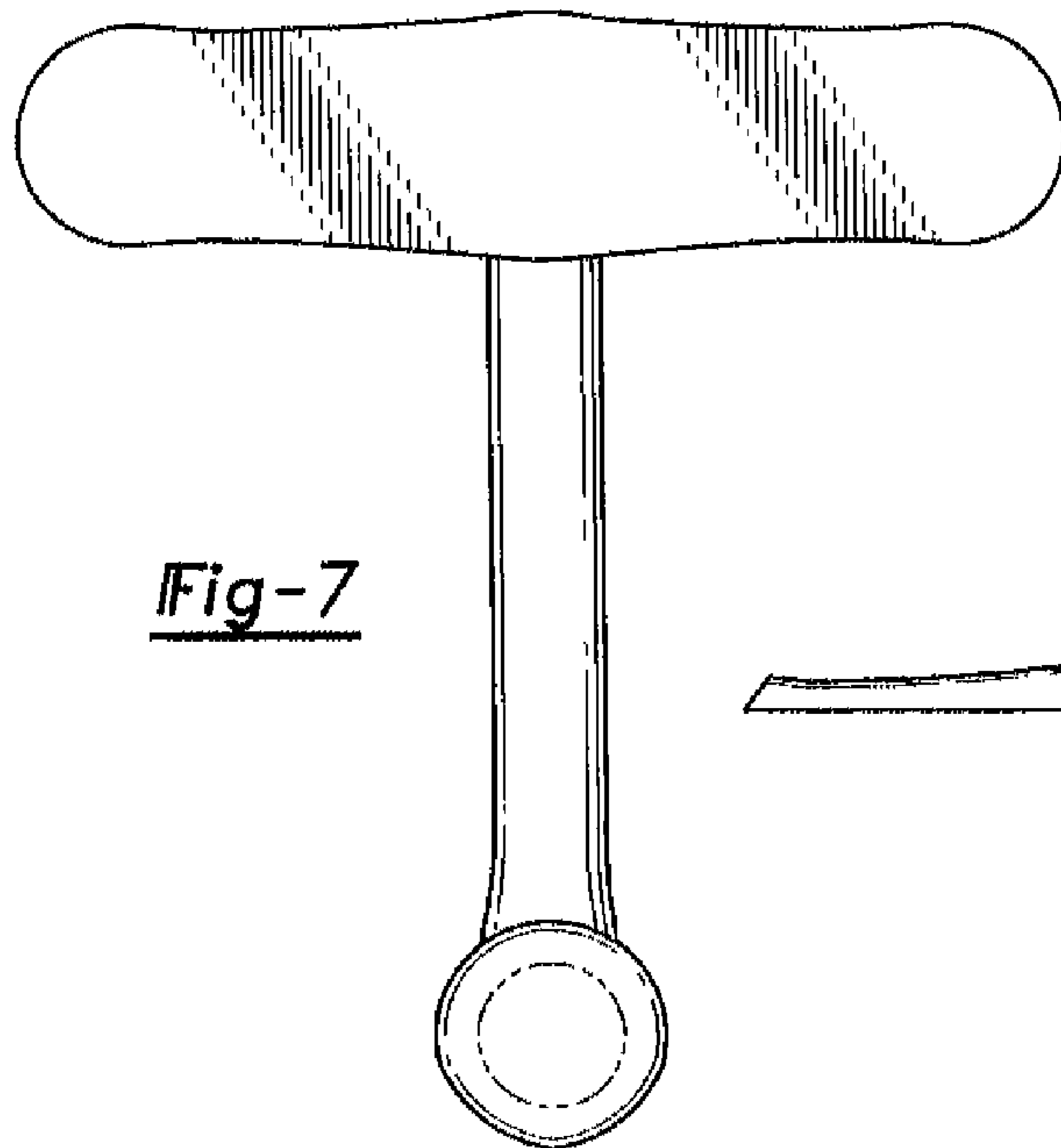

Fig-7

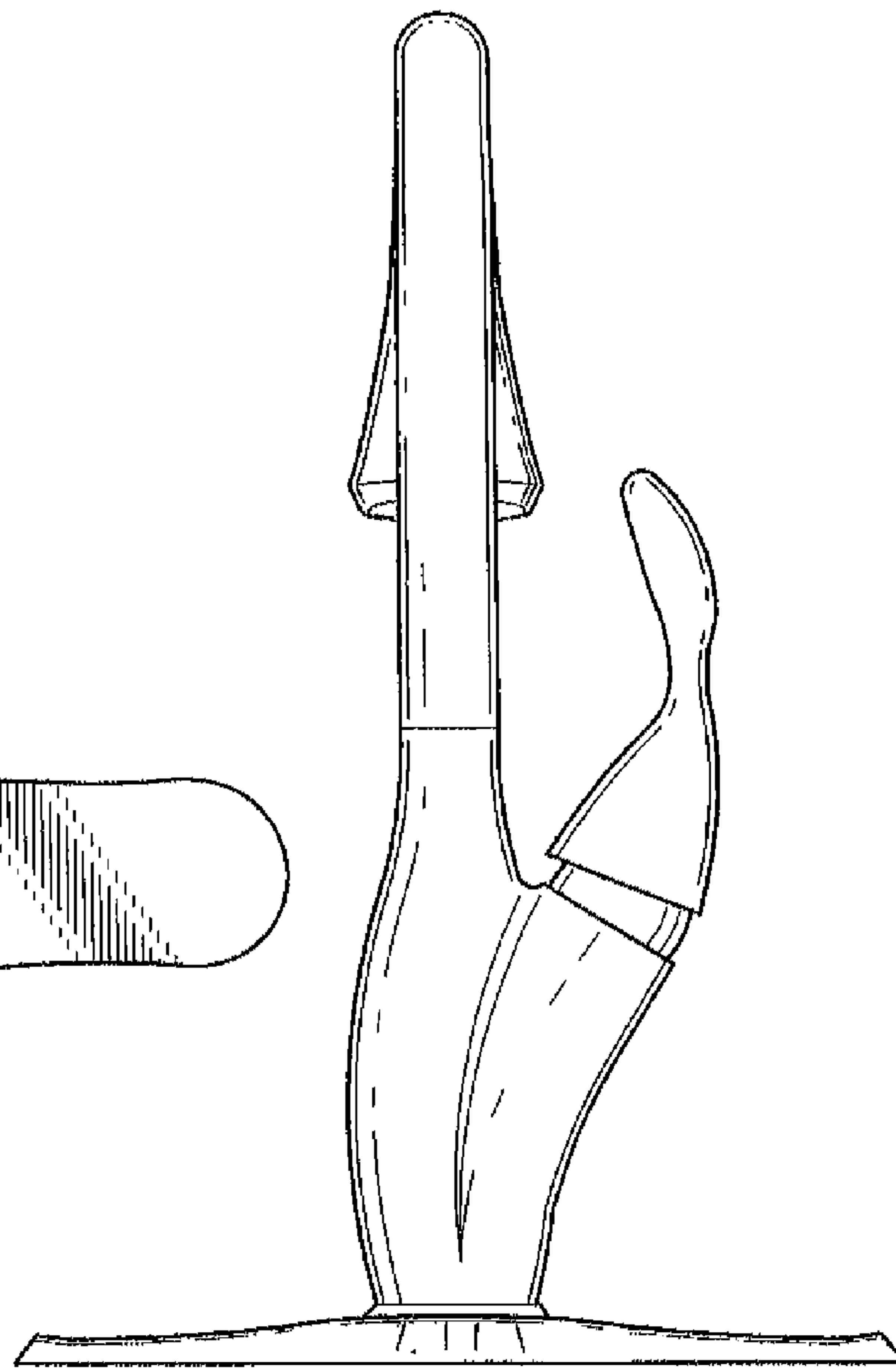

Fig-6