



US00D665864S

(12) **United States Design Patent**
Akhavain

(10) **Patent No.:** **US D665,864 S**

(45) **Date of Patent:** **** Aug. 21, 2012**

(54) **BODY SURFING BOARD**

(76) Inventor: **Mark Akhavain**, Long Beach, CA (US)

(**) Term: **14 Years**

(21) Appl. No.: **29/396,761**

(22) Filed: **Jul. 6, 2011**

(51) **LOC (9) Cl.** **21-02**

(52) **U.S. Cl.** **D21/769**

(58) **Field of Classification Search** D21/769-770,
D21/801, 803, 809; 114/253, 345-346; 441/35,
441/66, 40-42, 74, 75, 129-132; 472/128-129;
D12/5, 6, 316

See application file for complete search history.

(56) **References Cited**

U.S. PATENT DOCUMENTS

3,917,022	A *	11/1975	Brooks, Jr.	180/127
4,437,842	A	3/1984	Connor	
5,447,459	A *	9/1995	Hammond	441/135
D371,411	S *	7/1996	Albritton	D21/770
D383,183	S *	9/1997	Darejeh et al.	D21/770
D410,515	S *	6/1999	Alexander	D21/769
D473,823	S *	4/2003	McKee et al.	D12/10
D480,442	S *	10/2003	Peterson	D21/770
D517,635	S *	3/2006	Chiang	D21/801

OTHER PUBLICATIONS

Screenshot from YouTube, 2009 Redwings Memorial Handboarding Championships day 2, <http://www.youtube.com/watch?v=ULB8gHTtRvk>, uploaded Aug. 7, 2009.

* cited by examiner

Primary Examiner — Zenia Bennett

(74) *Attorney, Agent, or Firm* — Knobbe Martens Olson & Bear LLP

(57) **CLAIM**

The ornamental design for a body surfing board, as shown and described.

DESCRIPTION

FIG. 1 is a top, front, and side perspective of a body surfing board embodying my new design.

FIG. 2 is a top, back, and side perspective thereof.

FIG. 3 is a top view thereof.

FIG. 4 is a bottom view thereof.

FIG. 5 is a side view thereof, the opposite side being a mirror image.

FIG. 6 is a front plan view thereof; and,

FIG. 7 is a back plan view thereof.

Broken lines are used to illustrate features of the body surfing board which form no part of the claimed design.

1 Claim, 6 Drawing Sheets

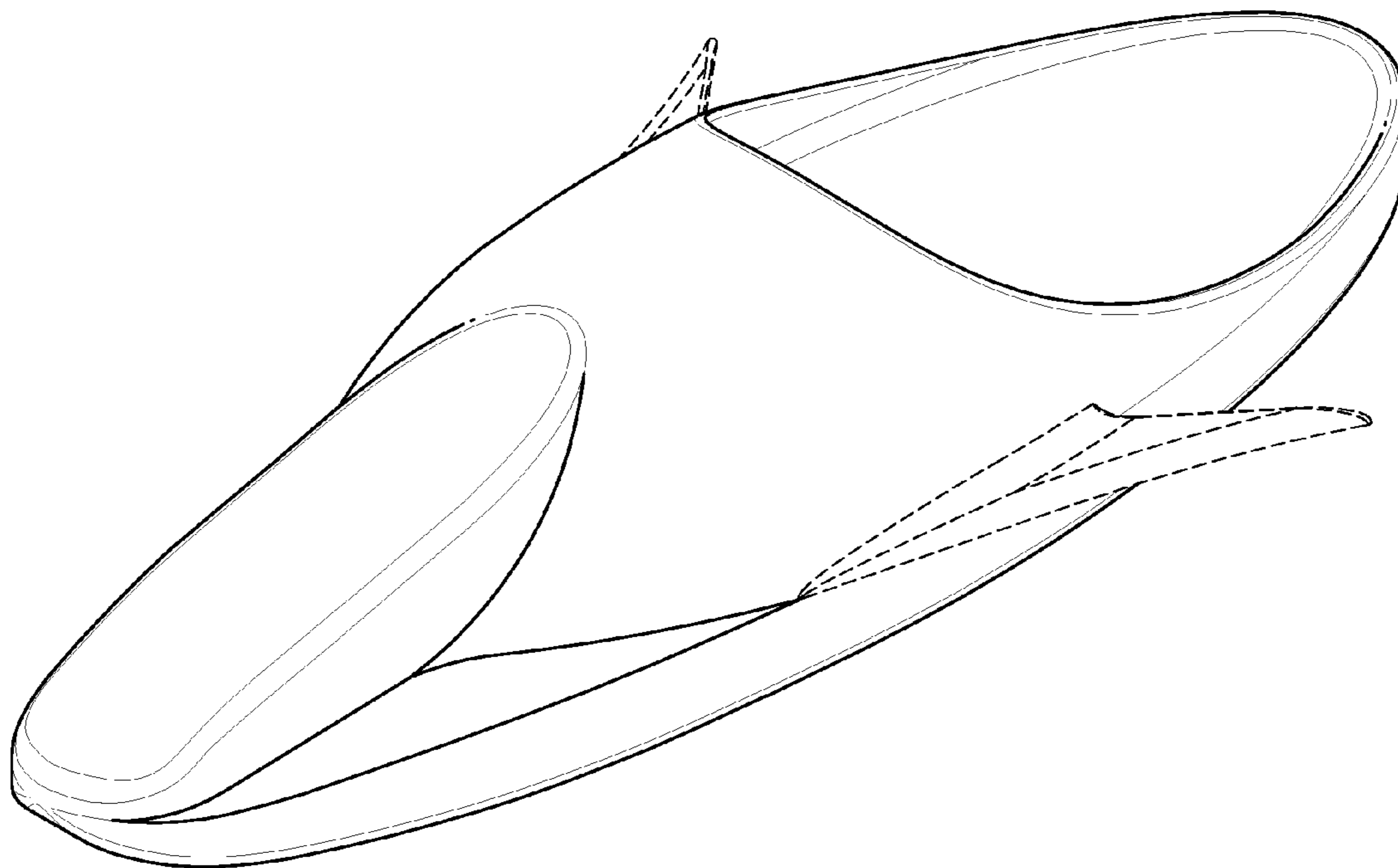



FIG. 1

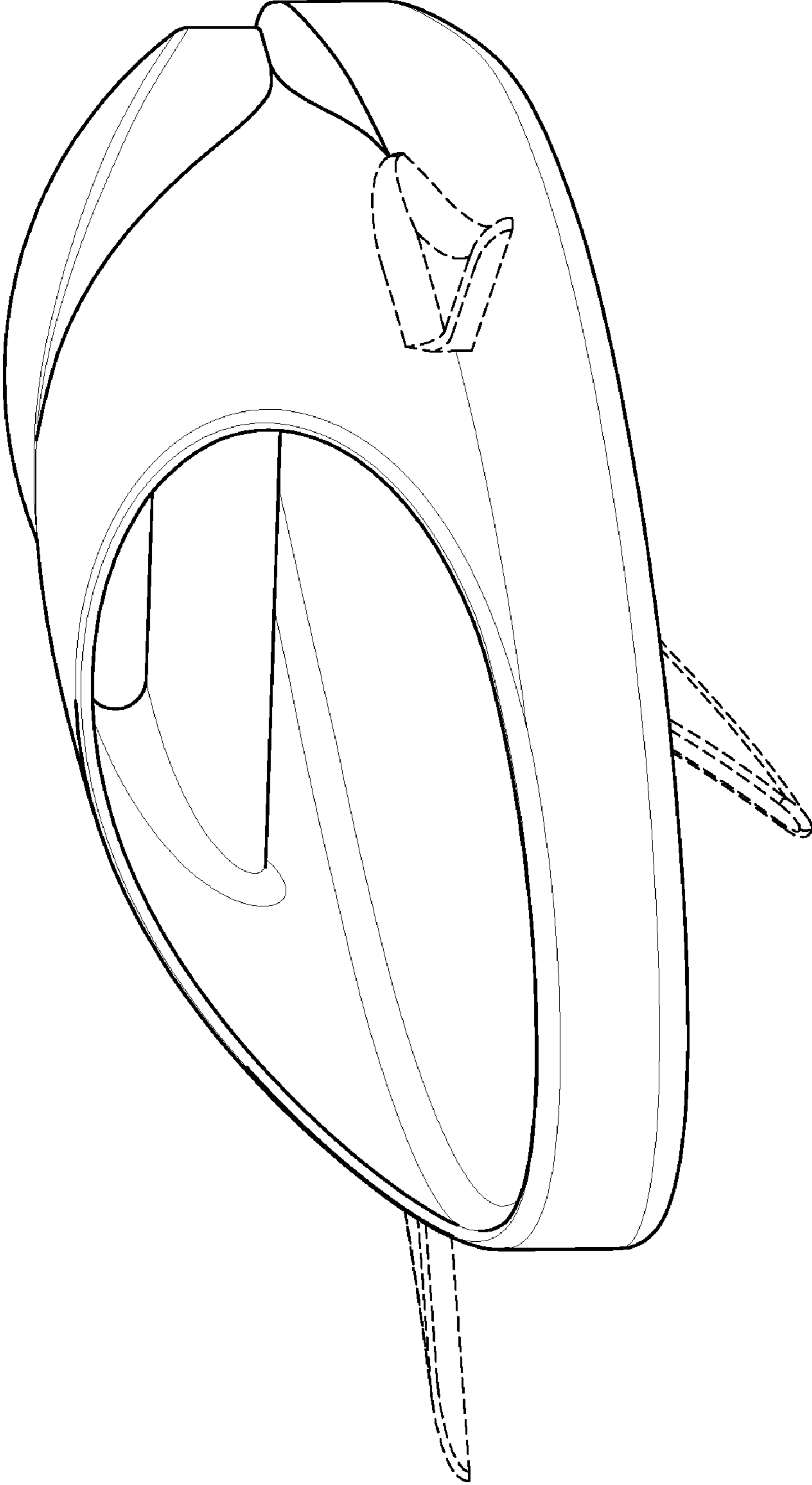

FIG. 2

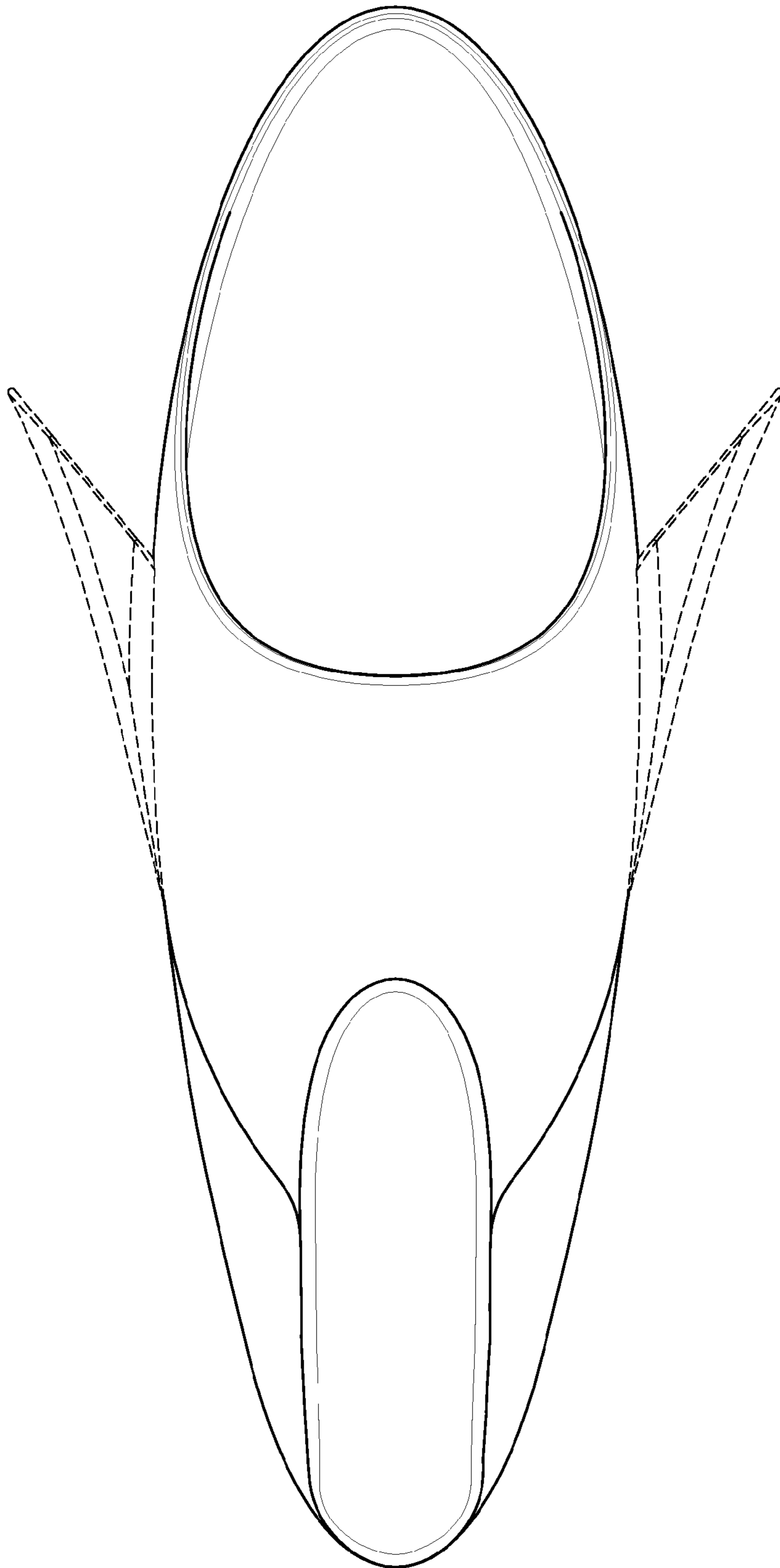

FIG. 3

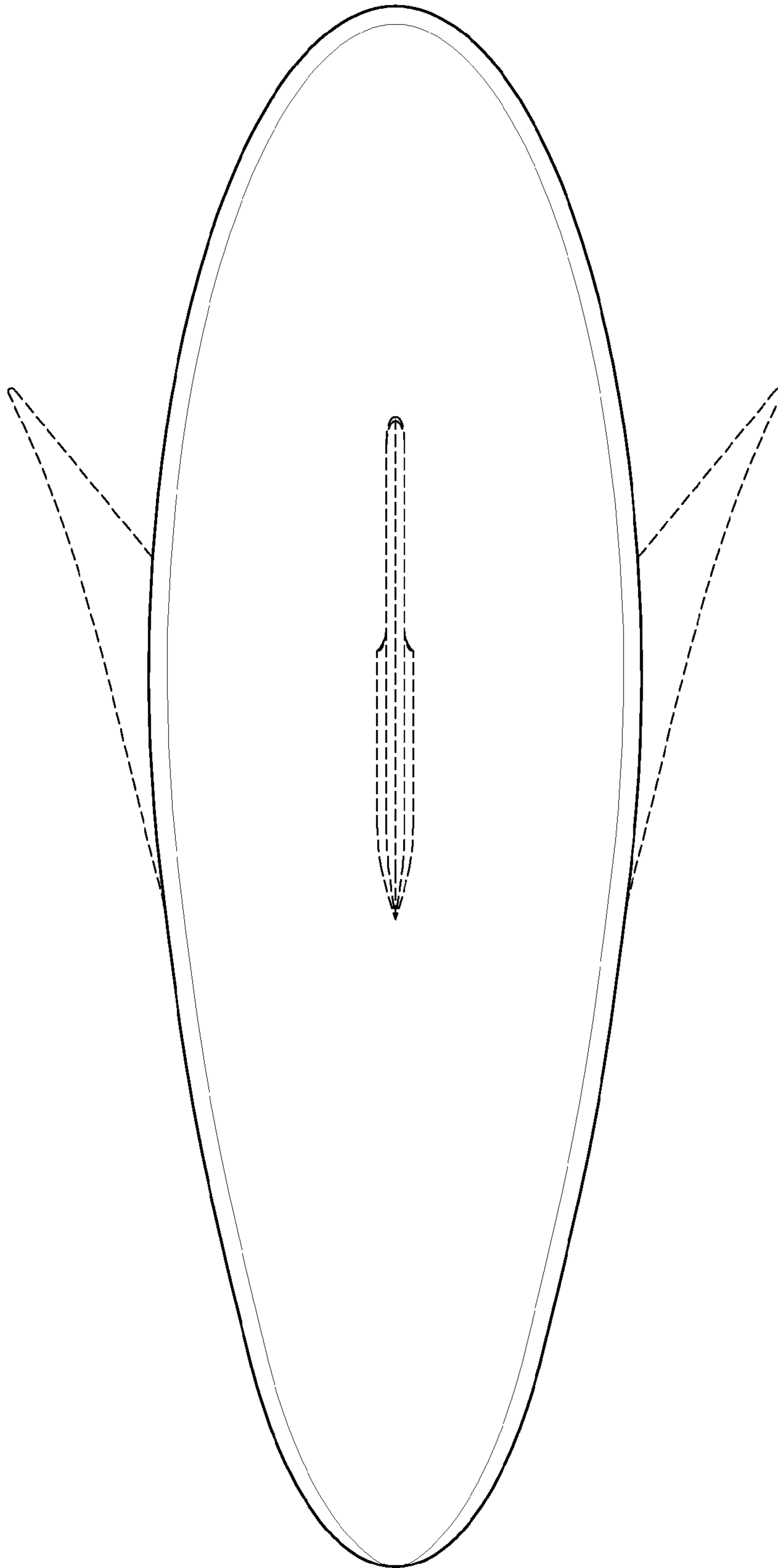

FIG. 4

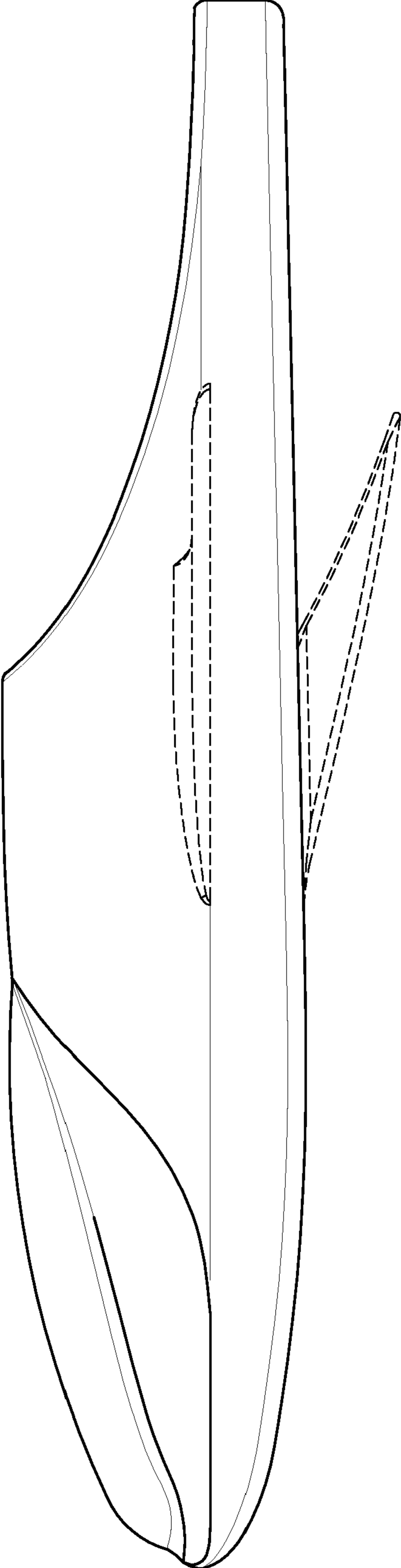

FIG. 5

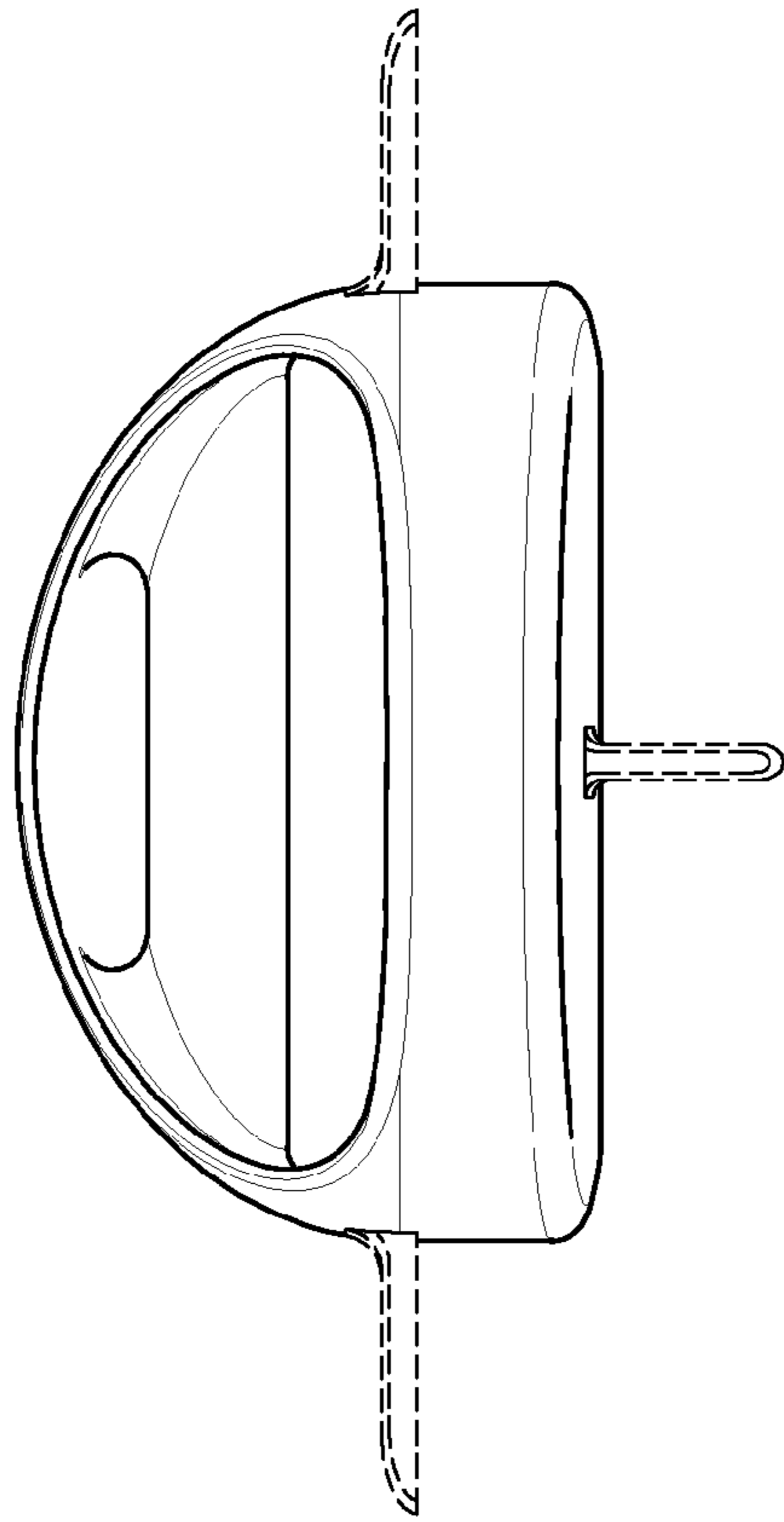

FIG. 7

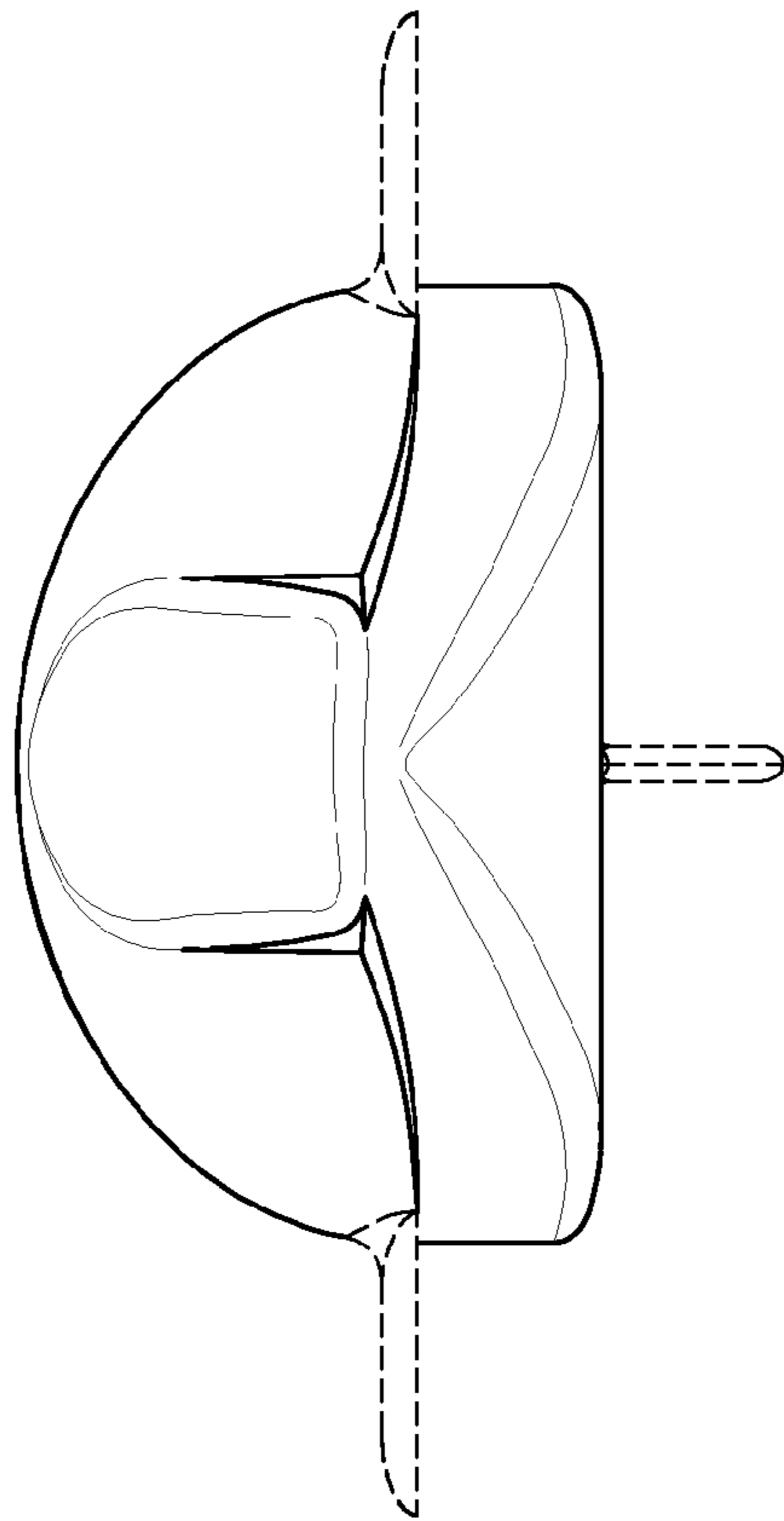

FIG. 6